

3D PAPER CRAFT

[Seasons & Holidays]

Christmas Tree



The customs of Christmas as we know it come from the traditional celebration of the birth of Christ, which was combined with the harvest and winter solstice festivals in ancient Rome. From ancient times, the celebration has involved making offerings and decorating with evergreens, as well as exchanging gifts.

The custom of the Christmas tree began in Germany. The evergreens used for the Christmas tree symbolize the eternal life. Early Christmas trees were decorated with apples, paper flowers, candy, and candles. The candles symbolize the stars shining in the sky above the forests. The candy cane came to be decorated from the choir of Germany having given the sugar cane to children as Christmas service. Today, various ornaments are seen on the Christmas trees.

* This Christmas tree is about 20 inches (50 cm) tall.

Directions

Build the tree FOLIAGE 1

FOLIAGE (LEVEL 4)

FOLIAGE 11

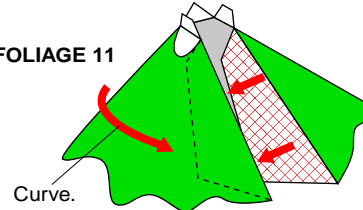

FOLIAGE (LEVEL 5)

FOLIAGE 12

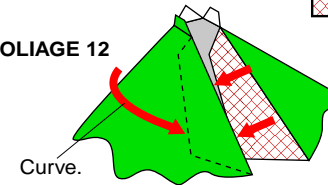

* For FOLIAGE (LEVELS 3-5), align the letters on the upper parts of the pieces and glue together as shown in the illustrations.

FOLIAGE (LEVEL 3)

FOLIAGE (LEVEL 2)

FOLIAGE 7

Curve.

FOLIAGE 6

Curve.

Curve.

FOLIAGE 10

FOLIAGE 9

Curve.

FOLIAGE 8

FOLIAGE SUPPORT

Curve.

FOLIAGE (LEVEL 1)

FOLIAGE 2

Curve.

FOLIAGE 3

Curve.

Curve.

FOLIAGE 4

FOLIAGE 5

Curve.

FOLIAGE 1

Attaching the FOLIAGE SUPPORT.

FOLIAGE (LEVEL 1)

Glue

Align the shape of the hole.

Directions

2 Build the tree STAND

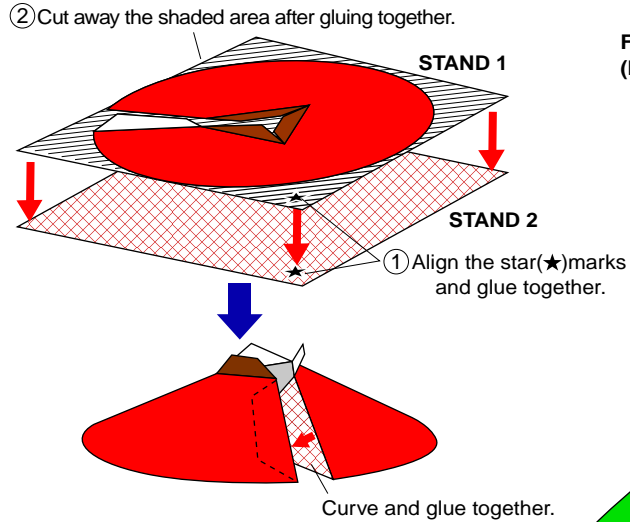

3 Build the tree TRUNK

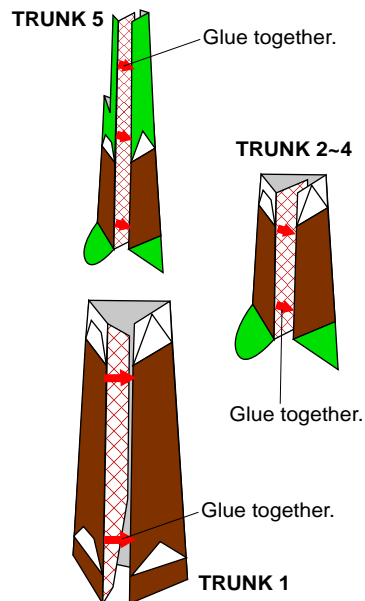

4 Attach the FOLIAGE, TRUNKS, and STAND

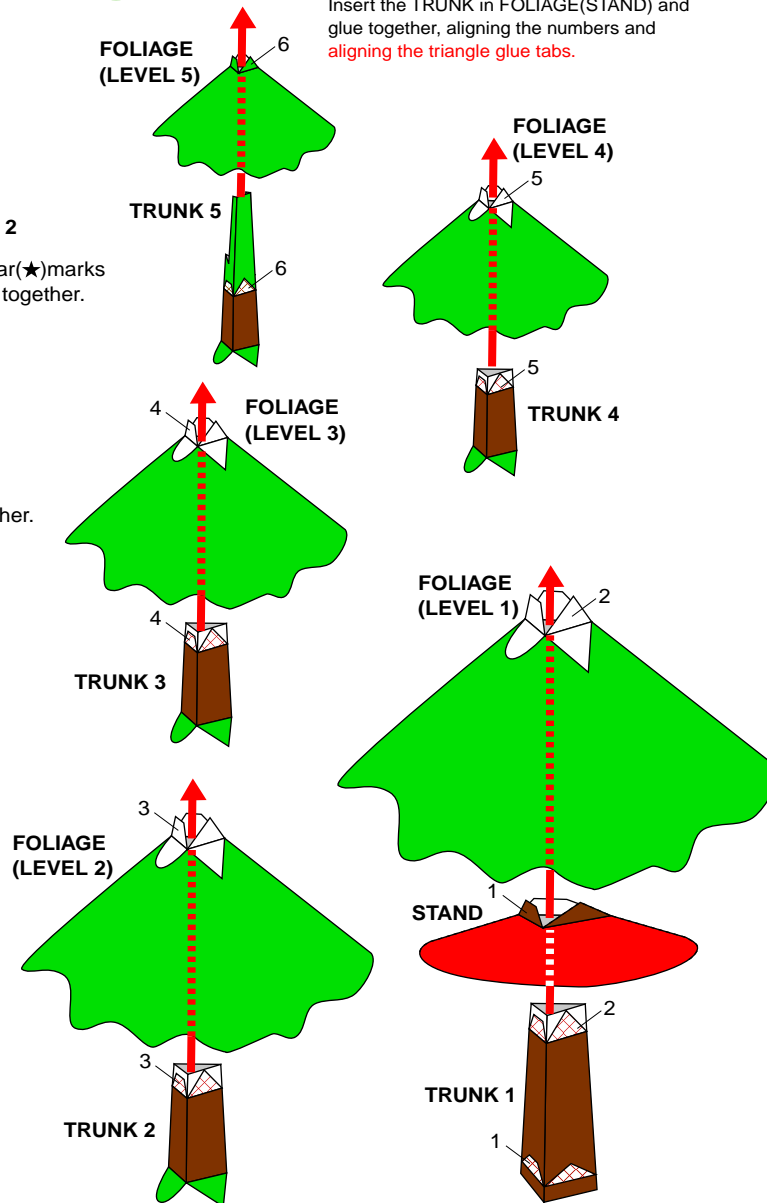

5 Build the tree

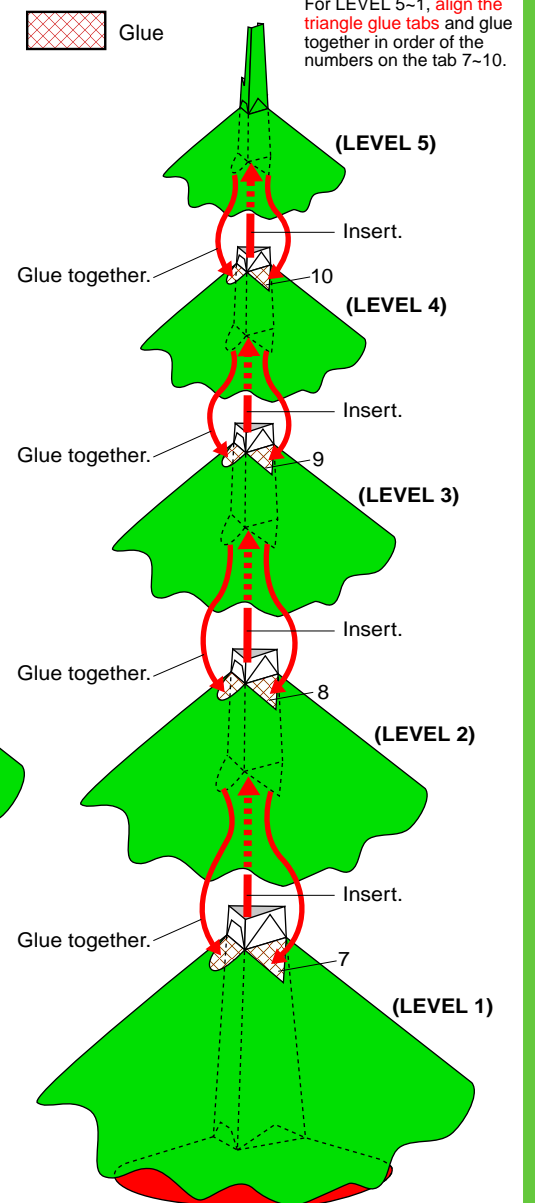

Directions

6 Build the ornaments

SANTA CLAUS



Glue together.

STAR

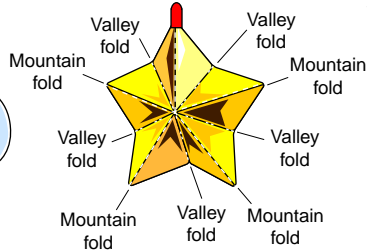

PRESENT

Fold along fold lines and glue together.



STOCKING



Glue together.

BELL

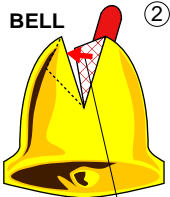

Glue together.

② Cut away the shaded area after gluing together.

CANDY CANE

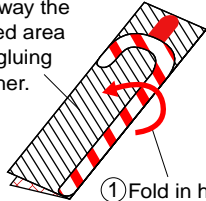

① Fold in half and glue together.

CANDLE

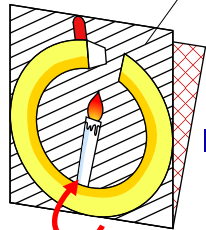

① Fold in half and glue together.

② Cut away the shaded area after gluing together.

Glue together.

Align the matching marks and glue together to form one long RIBBON.

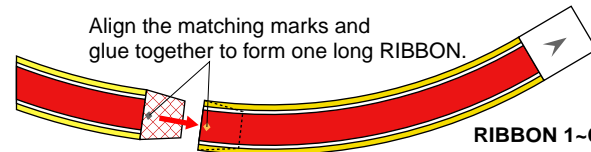

RIBBON 1-6

* Build RIBBON 7-12 in the same way.

7 Build the STAR for the top of the tree

STAR(FRONT)

① Fold in the same manner as STAR, direction 6.

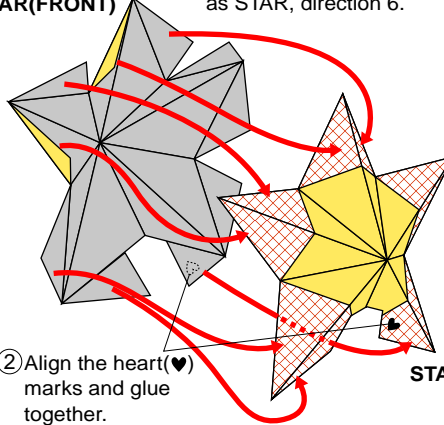

STAR(BACK)

② Align the heart(♥) marks and glue together.

8 Build the RIBBON

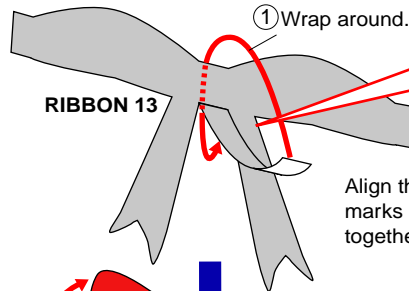

① Wrap around.

Align the arrow(◀) marks and glue together.

② Curve.

③ Align the arrow(◀) marks and glue together.

Glue ornaments to the ◯ marks on the RIBBON.

9 Decorate the tree with the ornaments



② Align the marks and glue the RIBBON.

⑥ Place the STAR on the top of the tree.

RIBBON 1-6

RIBBON 7-12

① Align the marks and glue together.

⑤ Align the star(★)marks and glue the BELL.

BELL

③ Align the star(★)marks and glue.



* You may glue the ornaments to the ◯ marks on the RIBBON, or to the tree FOLIAGE if you prefer. Refer to the illustration on page 1 for one example.

④ Align the star(★)marks and glue.

TRUNK 1

- Cut line
- - - Mountain fold
- · - · - Valley fold

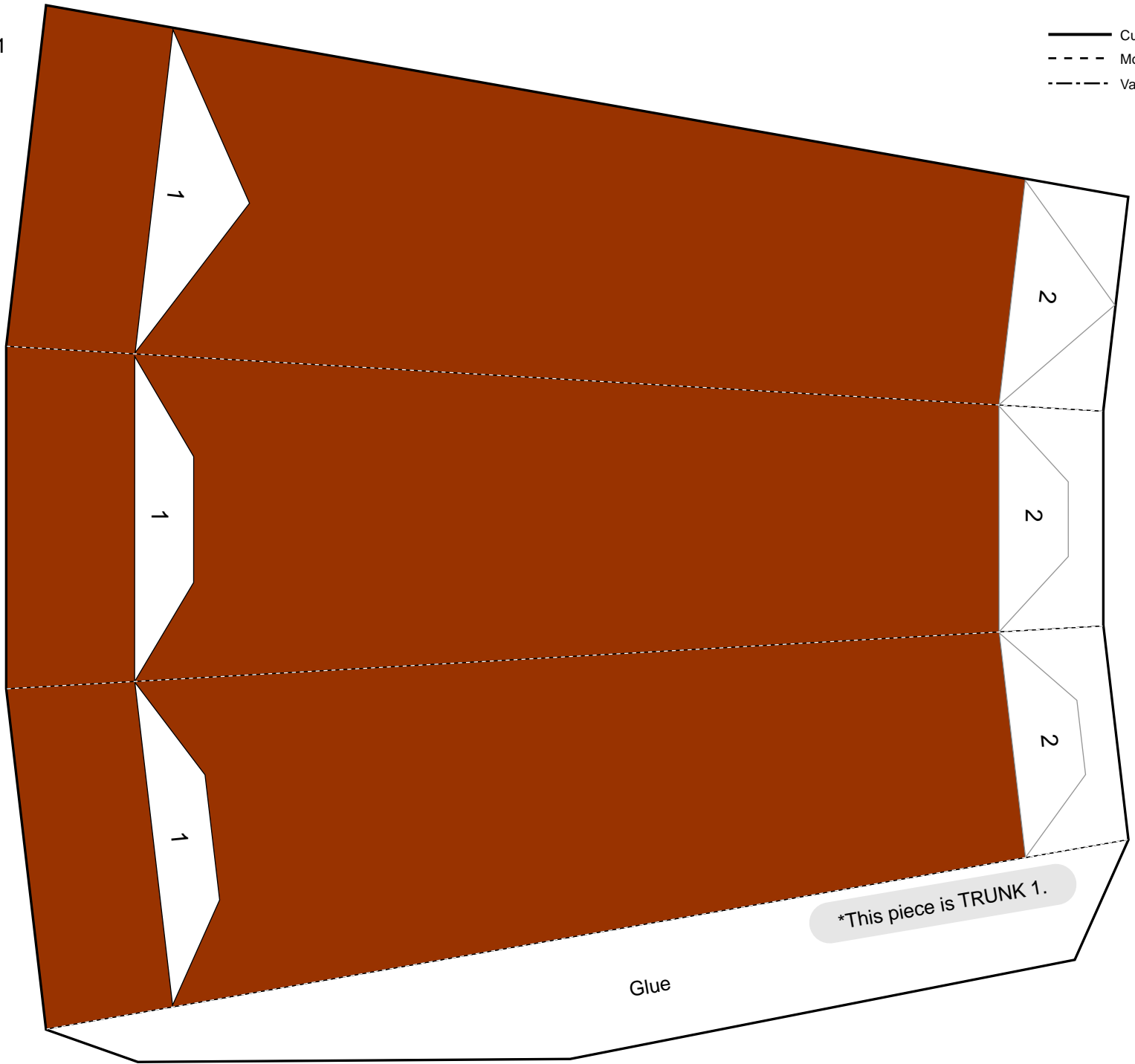

*This piece is TRUNK 1.

Glue

TRUNK 2



TRUNK 4

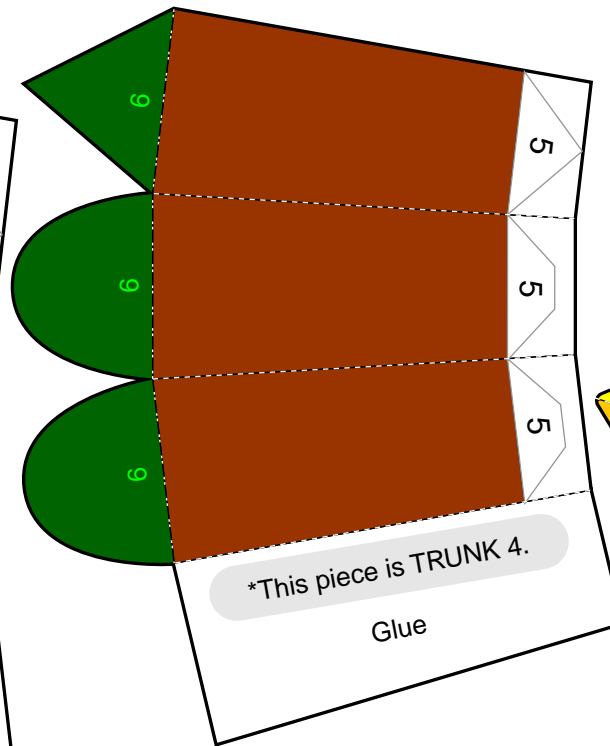

- Cut line
- - - Mountain fold
- · - Valley fold

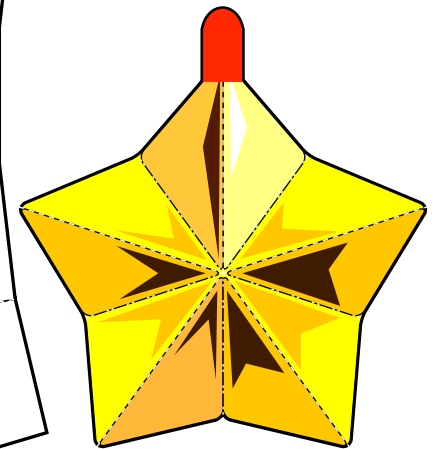

STAR

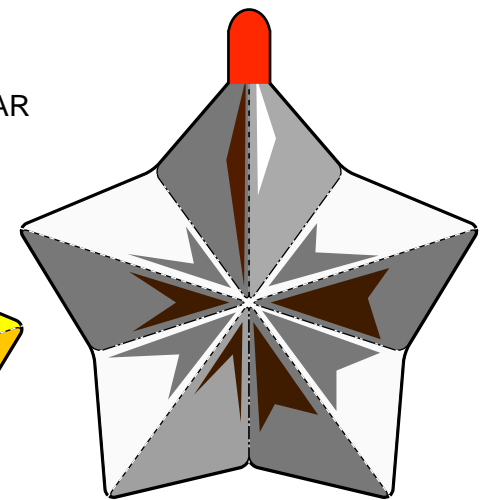
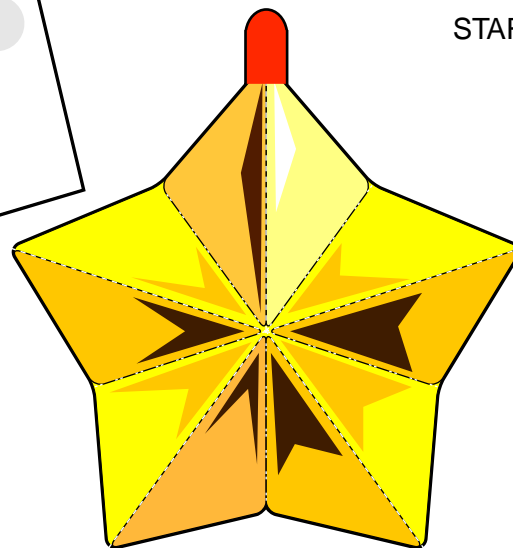

TRUNK 3

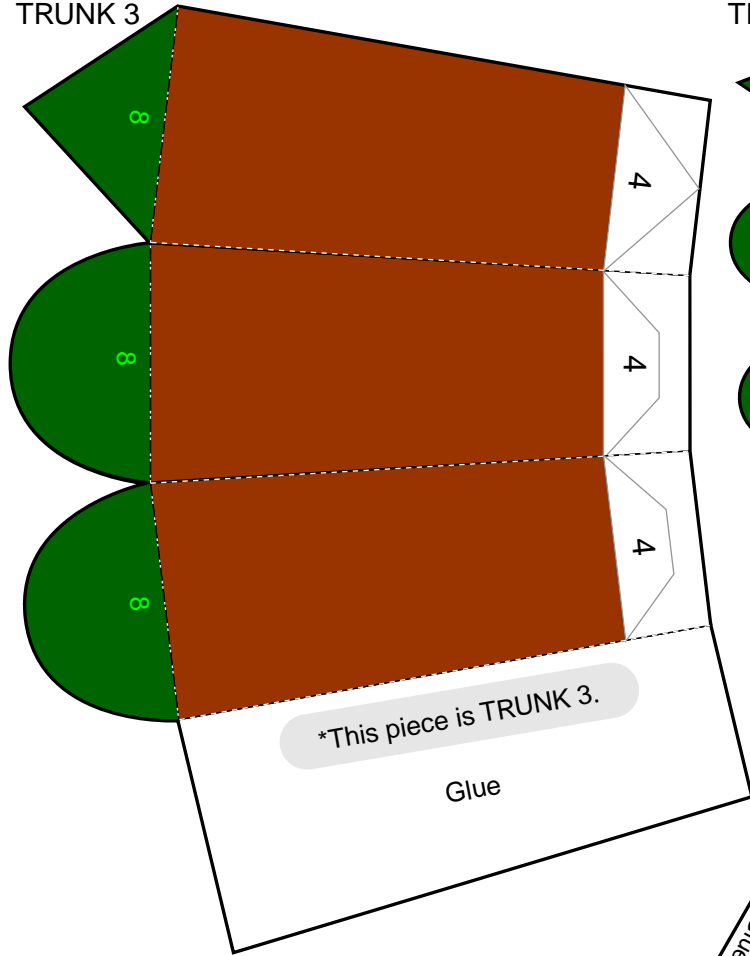

TRUNK 5

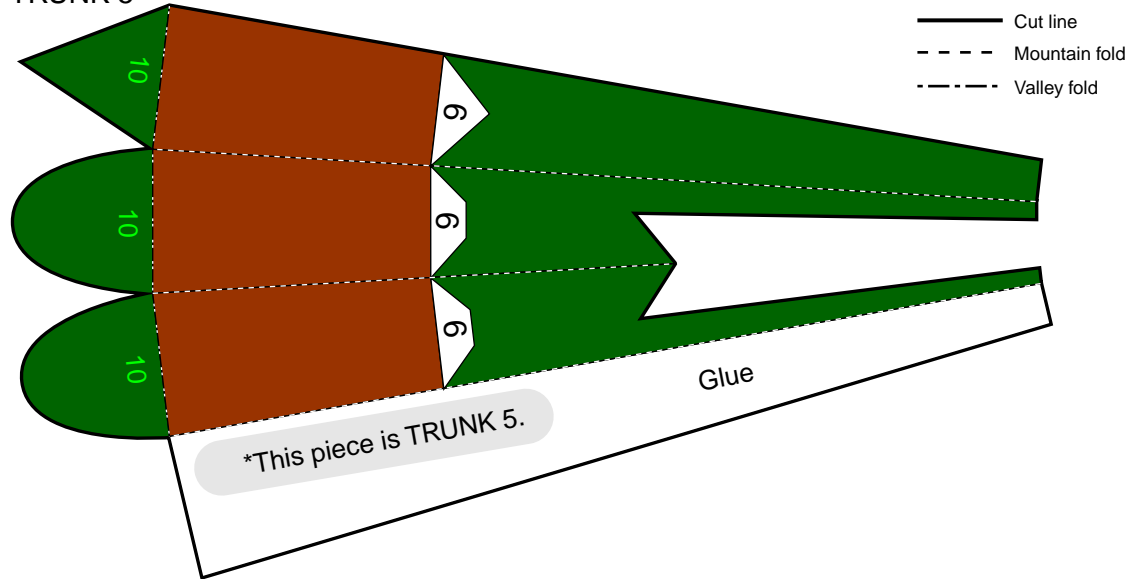

STAR(FRONT)
-for the top

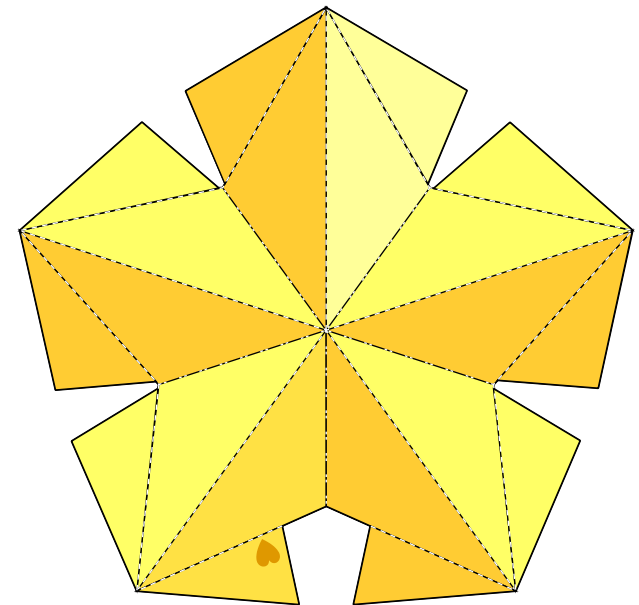

STAR(BACK)
-for the top

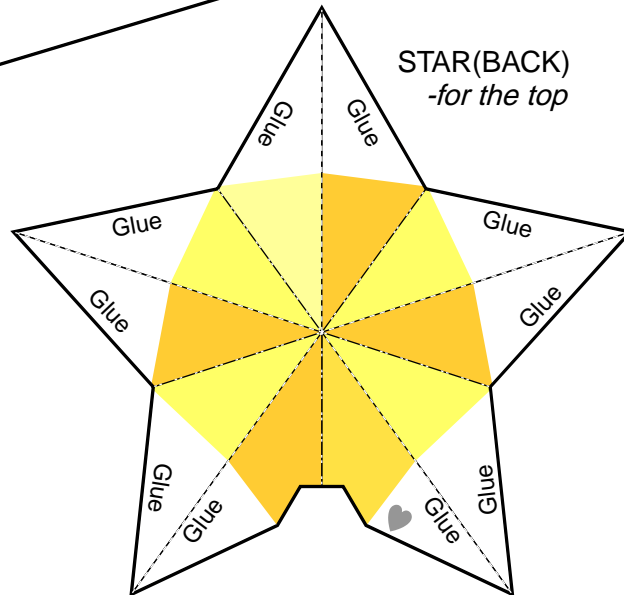

- Cut line
- - - Mountain fold
- · - · Valley fold



STOCKING

FOLIAGE 1

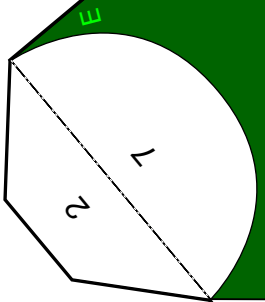

Glue to FOLIAGE 5.

*This piece is FOLIAGE 1.

PAPER CRAFT
Canon 3D-Papercraft
<http://bj.canon.co.jp/english/3d-papercraft/>
Canon® is a registered trademark of Canon Inc.
© D-Japan, Inc.

- Cut line
- - - Mountain fold
- · - · Valley fold

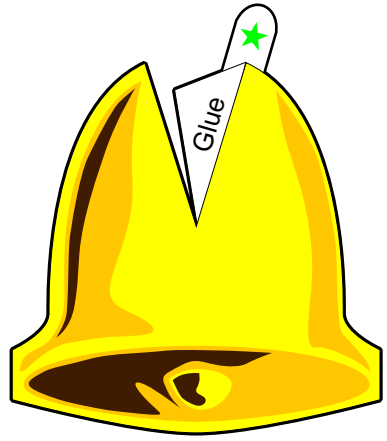

BELL

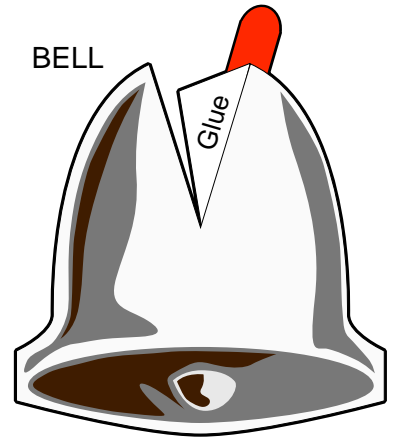

BELL

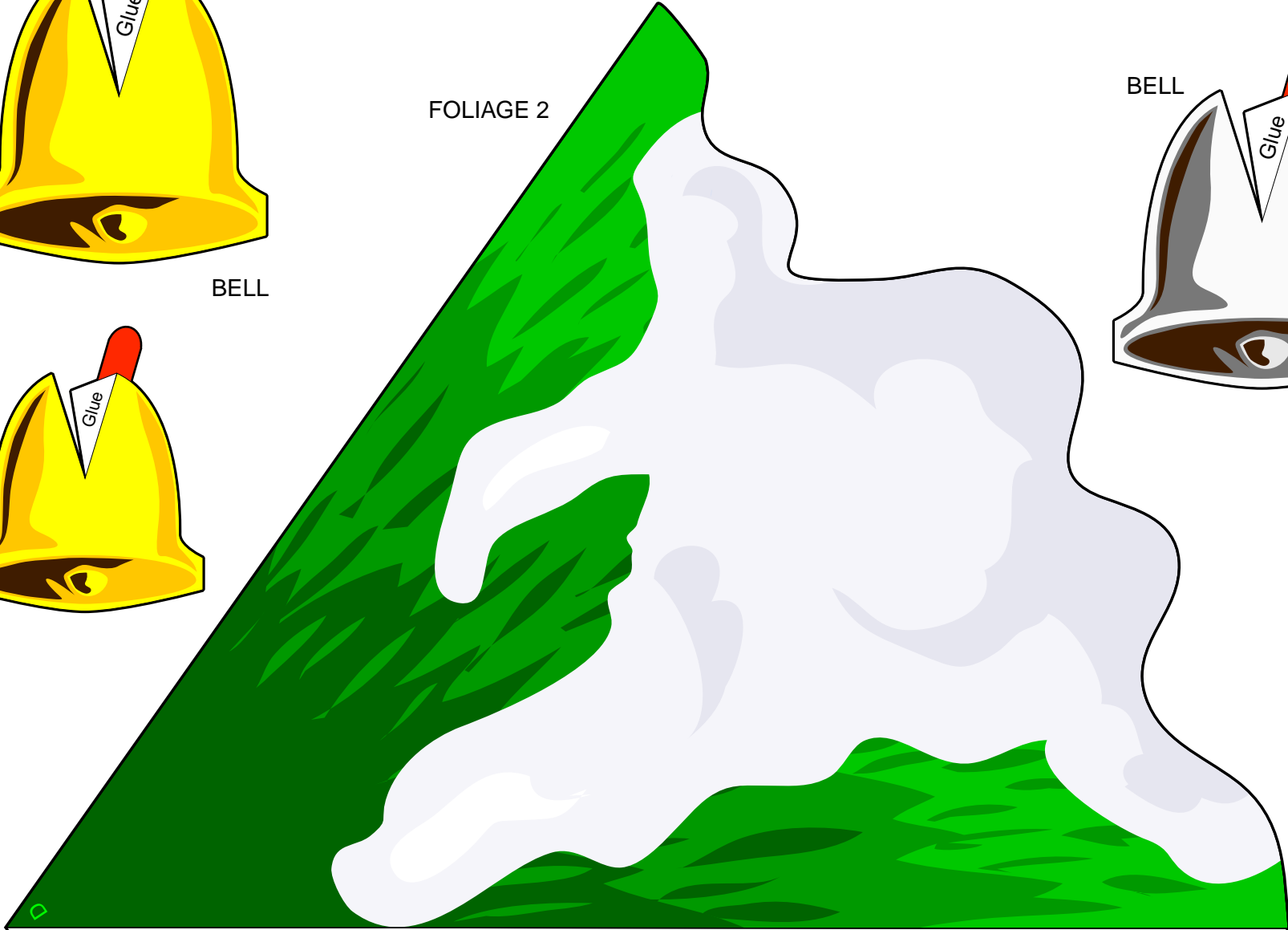
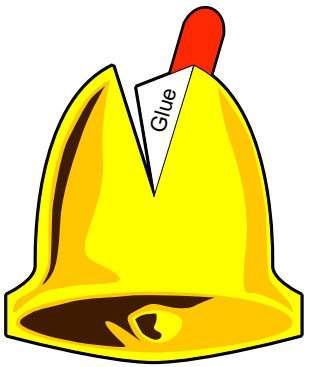

FOLIAGE 2

D
E

Glue to FOLIAGE 1.

*This piece is FOLIAGE 2.

- Cut line
- - - Mountain fold
- · - · - Valley fold

PRESENT

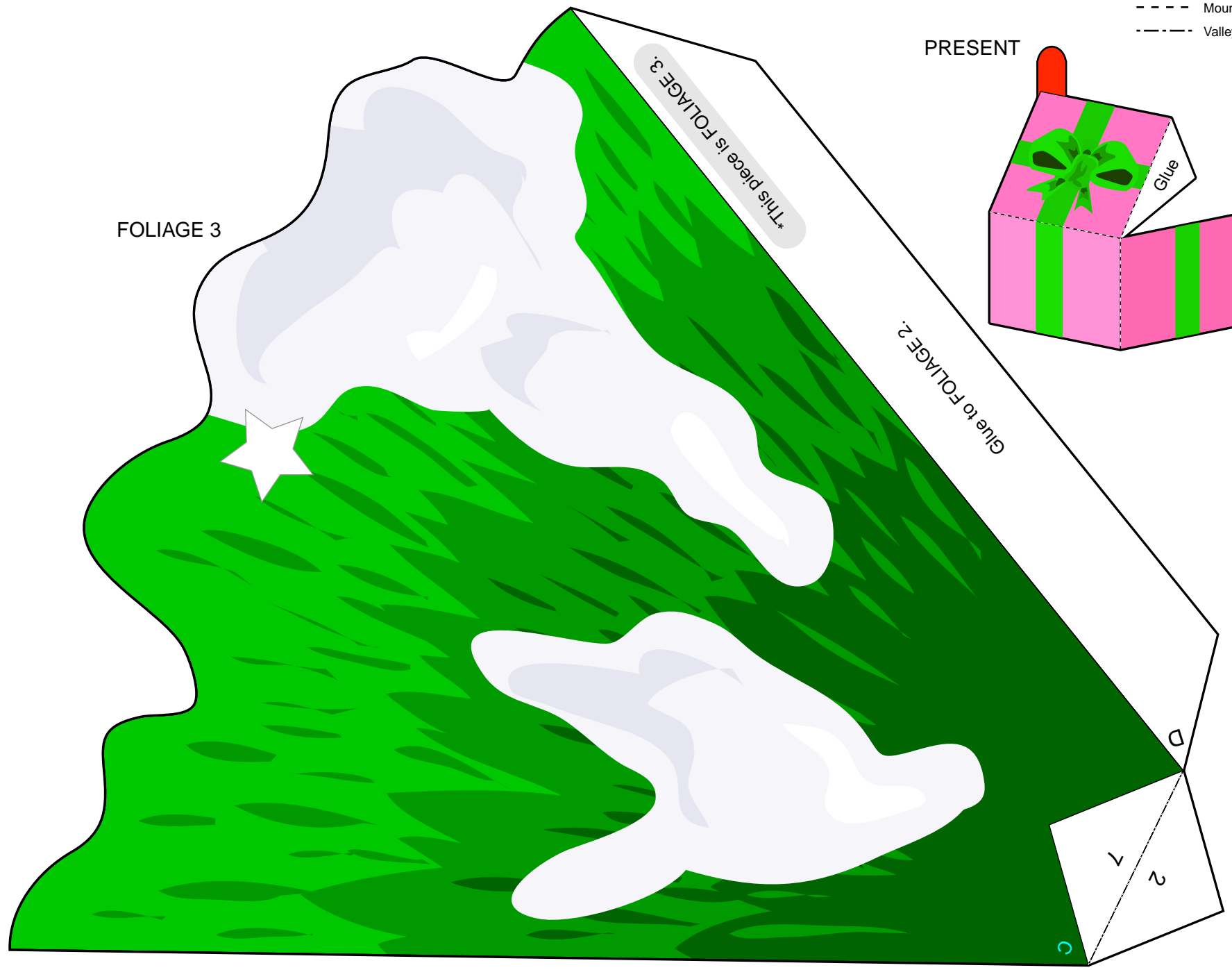



- Cut line
- - - Mountain fold
- · - Valley fold



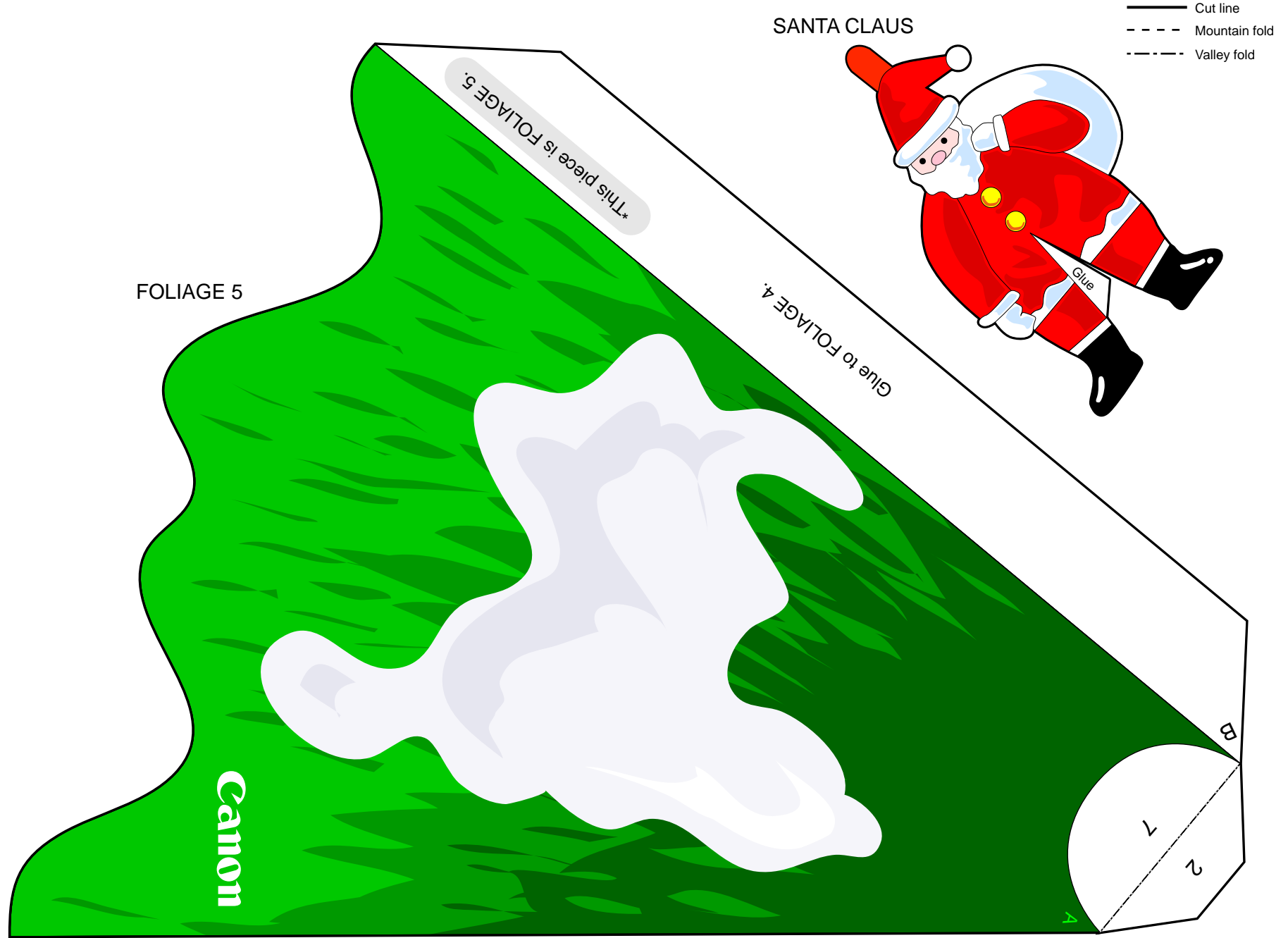

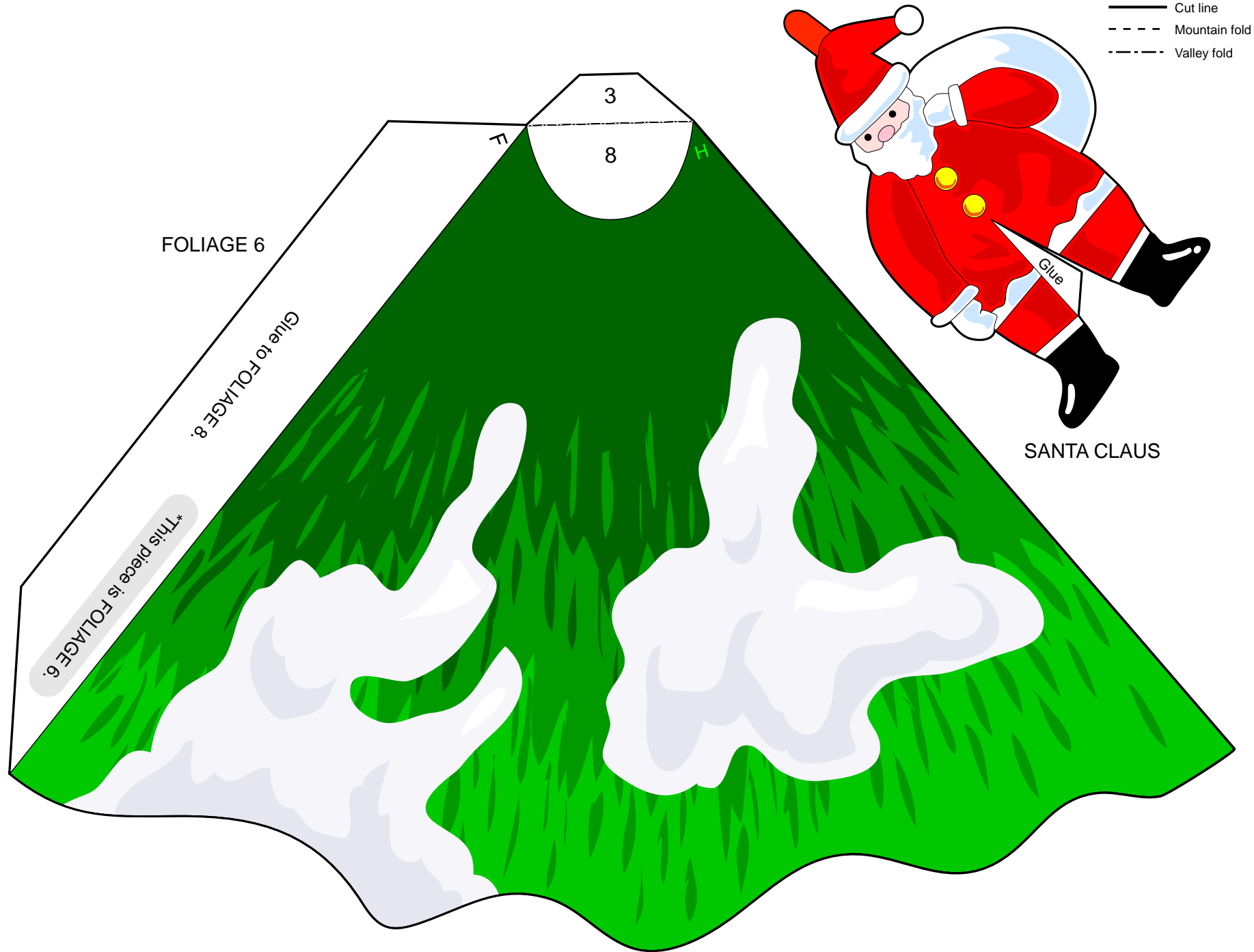

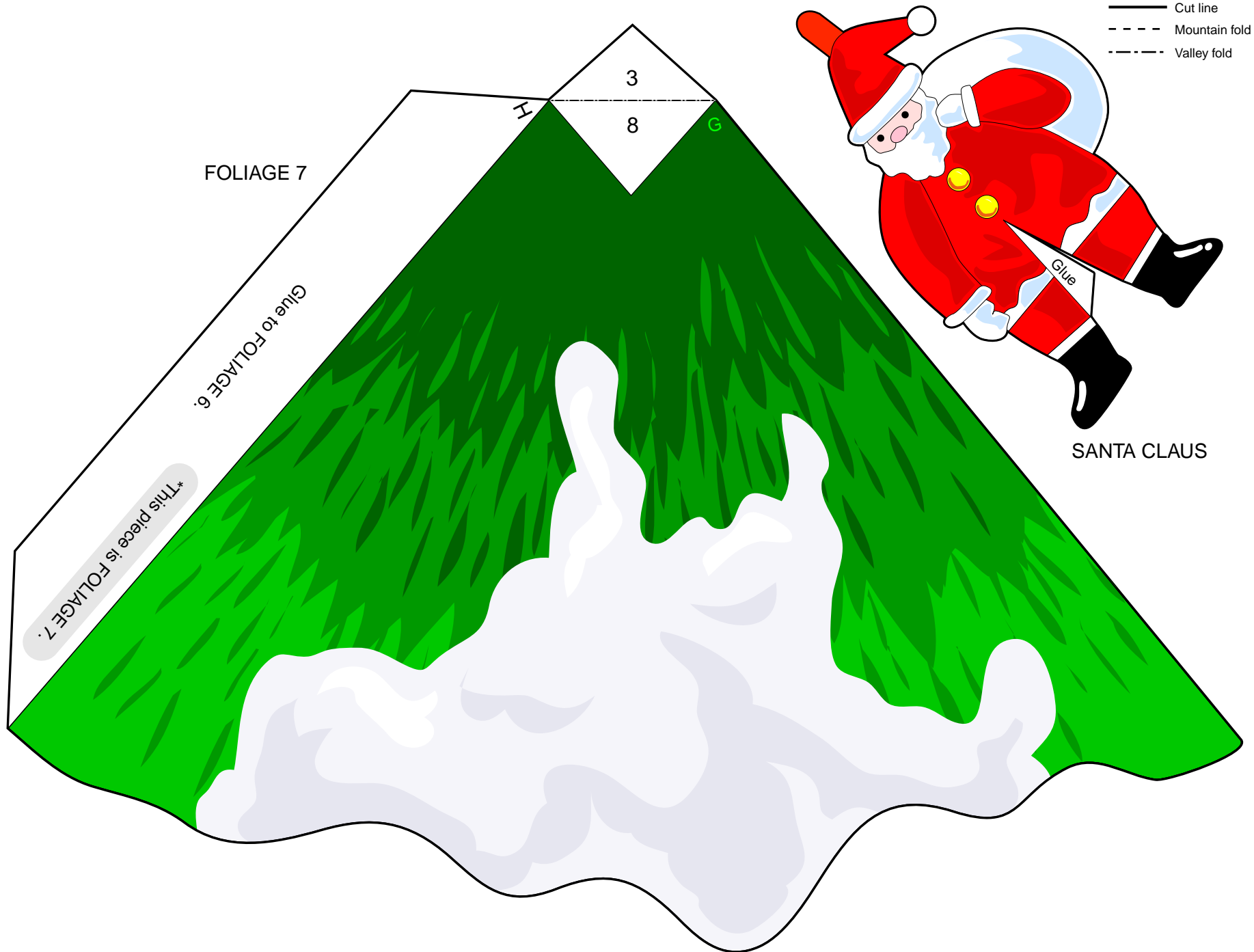

- Cut line
- - - Mountain fold
- · - · - Valley fold

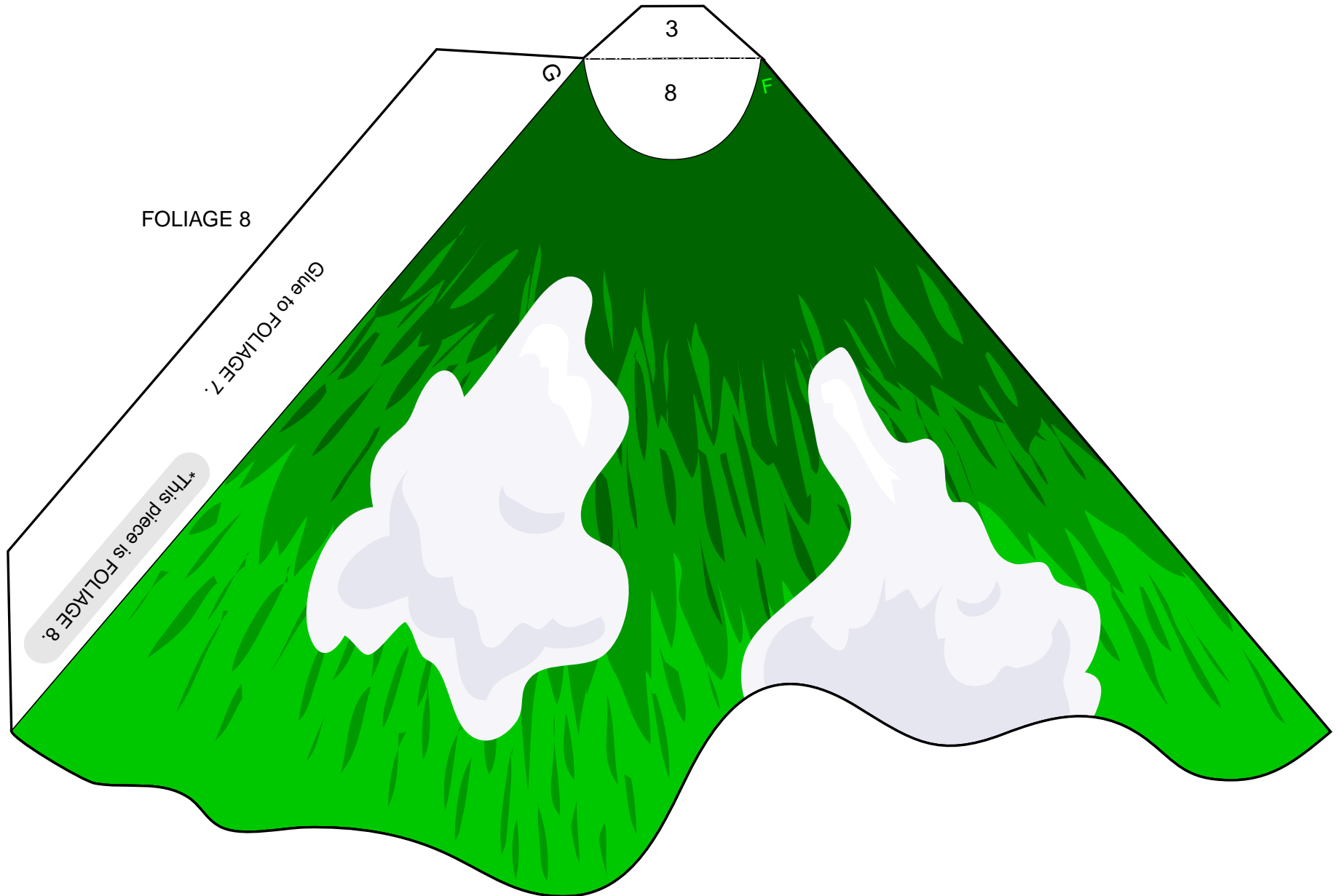

- Cut line
- - - Mountain fold
- · - · - Valley fold

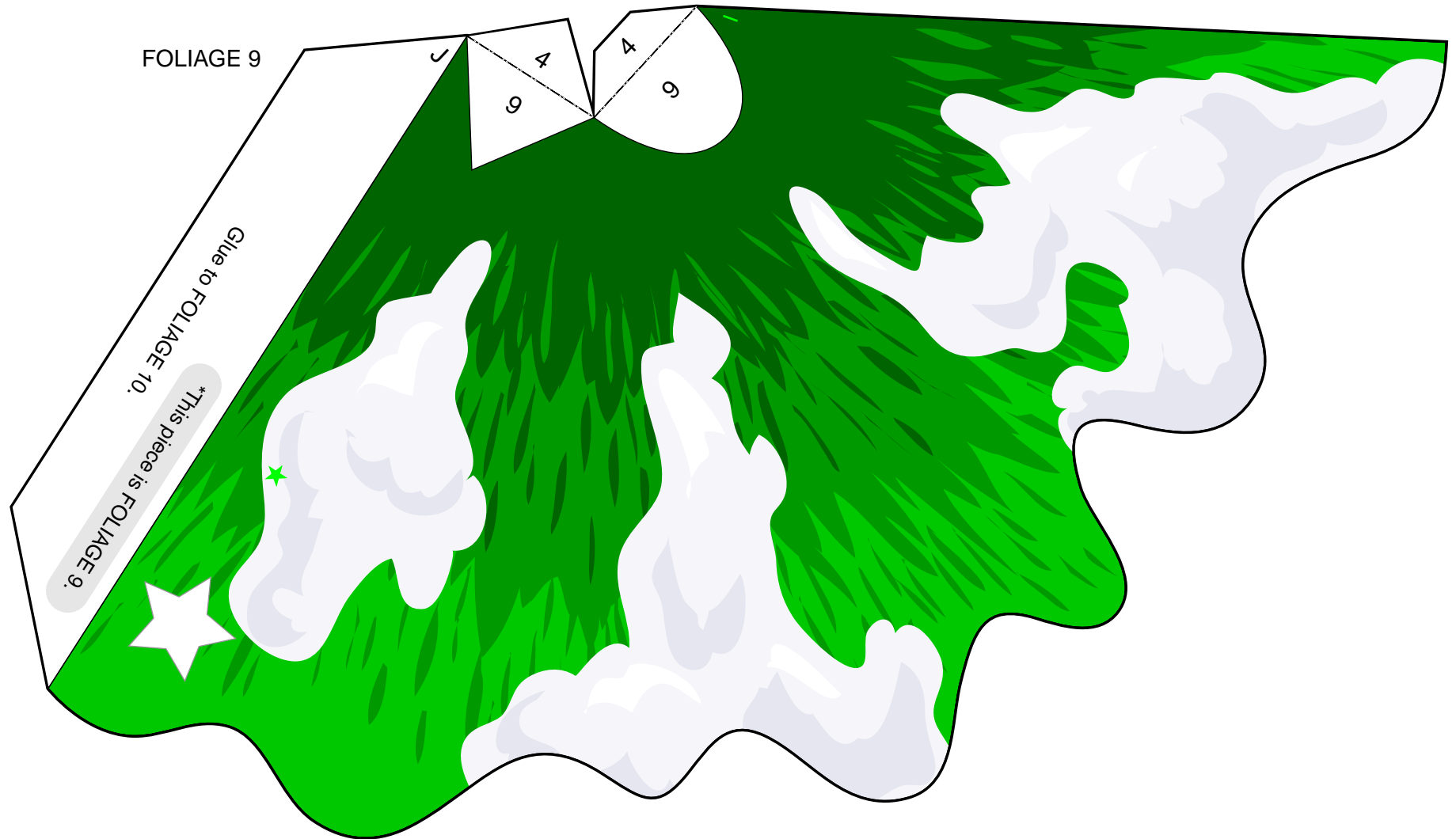

- Cut line
- - - Mountain fold
- · - · - Valley fold

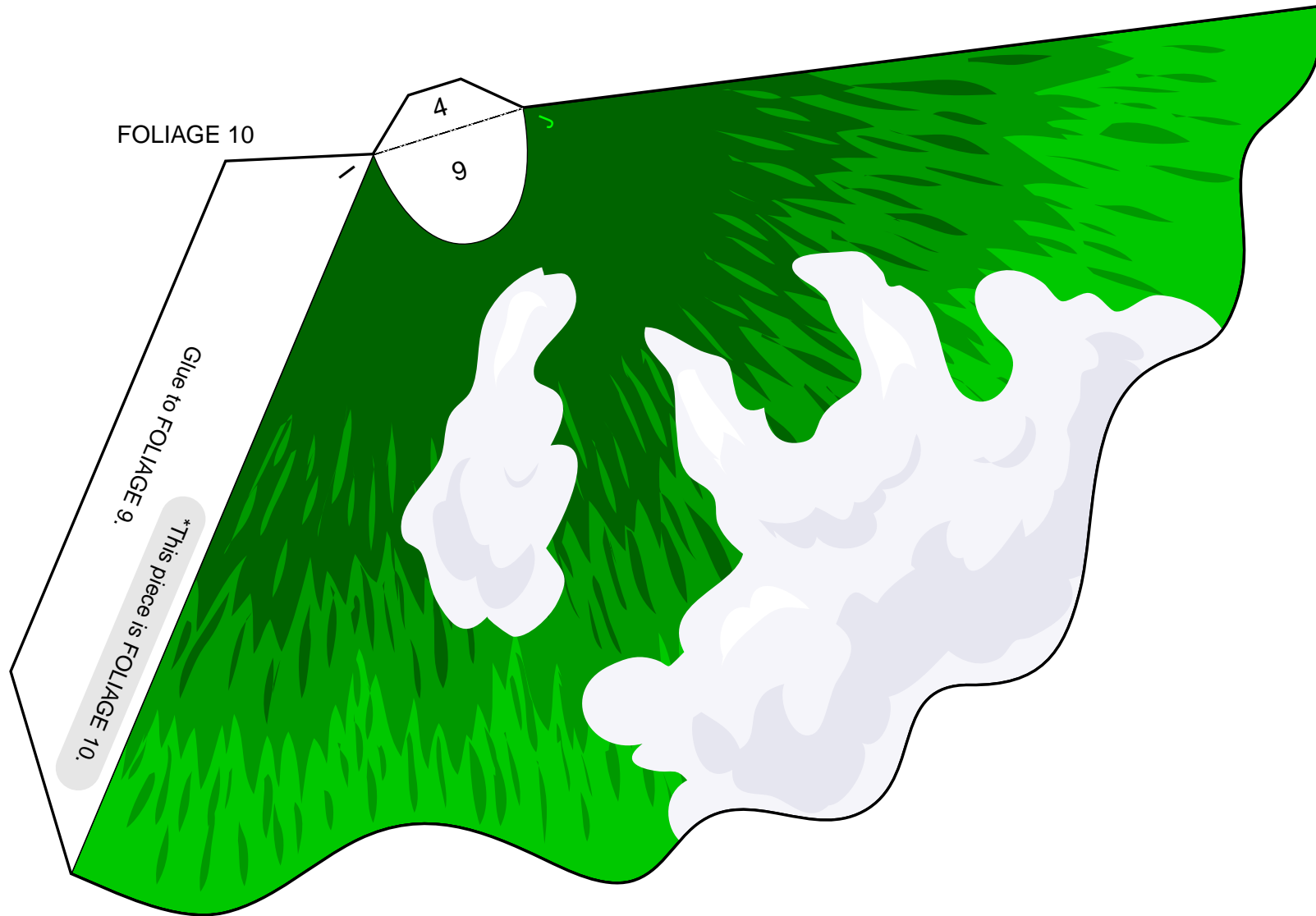

- Cut line
- - - Mountain fold
- · - · - Valley fold

FOLIAGE 11

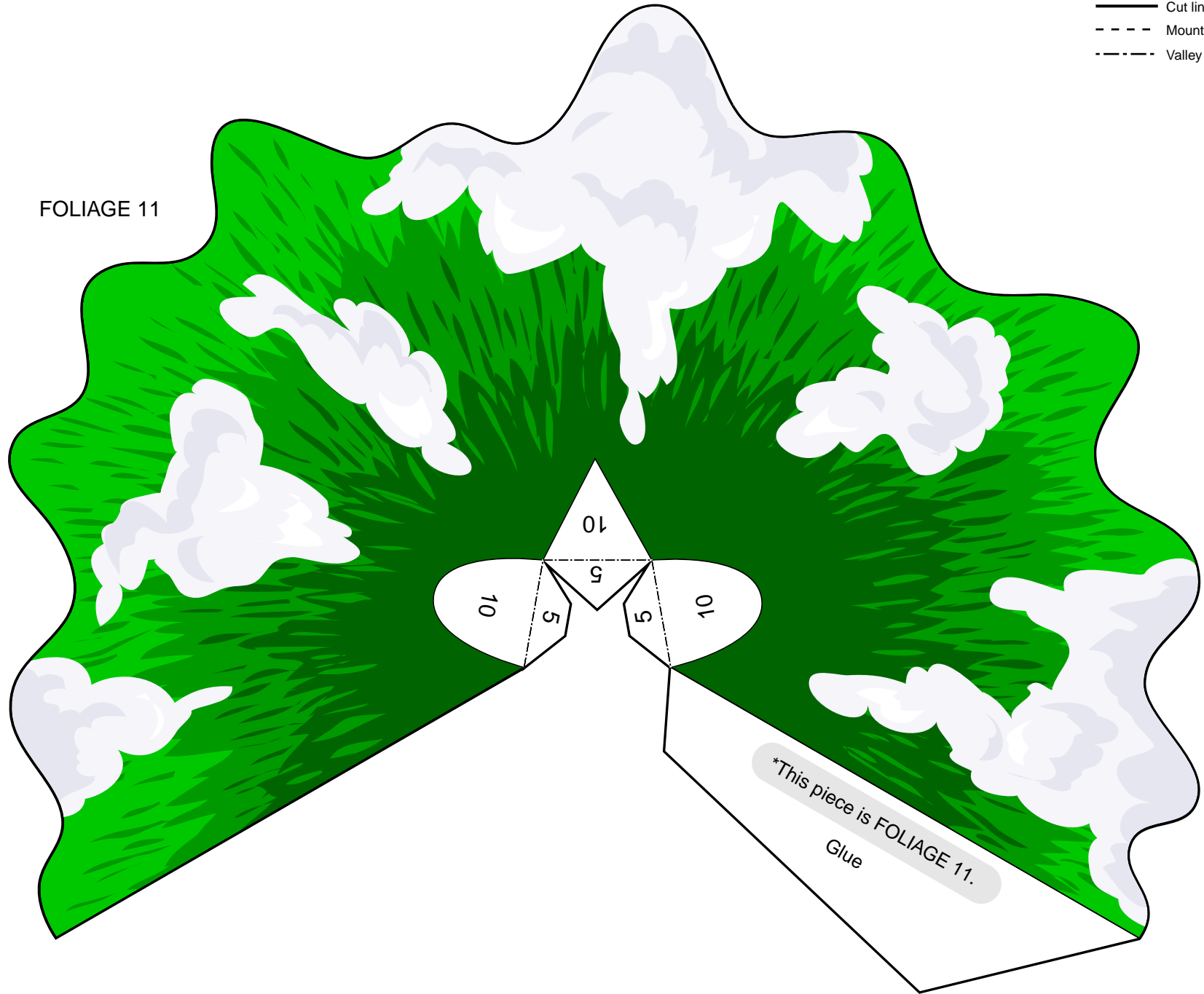

- Cut line
- - - Mountain fold
- - - - Valley fold



STAND 1

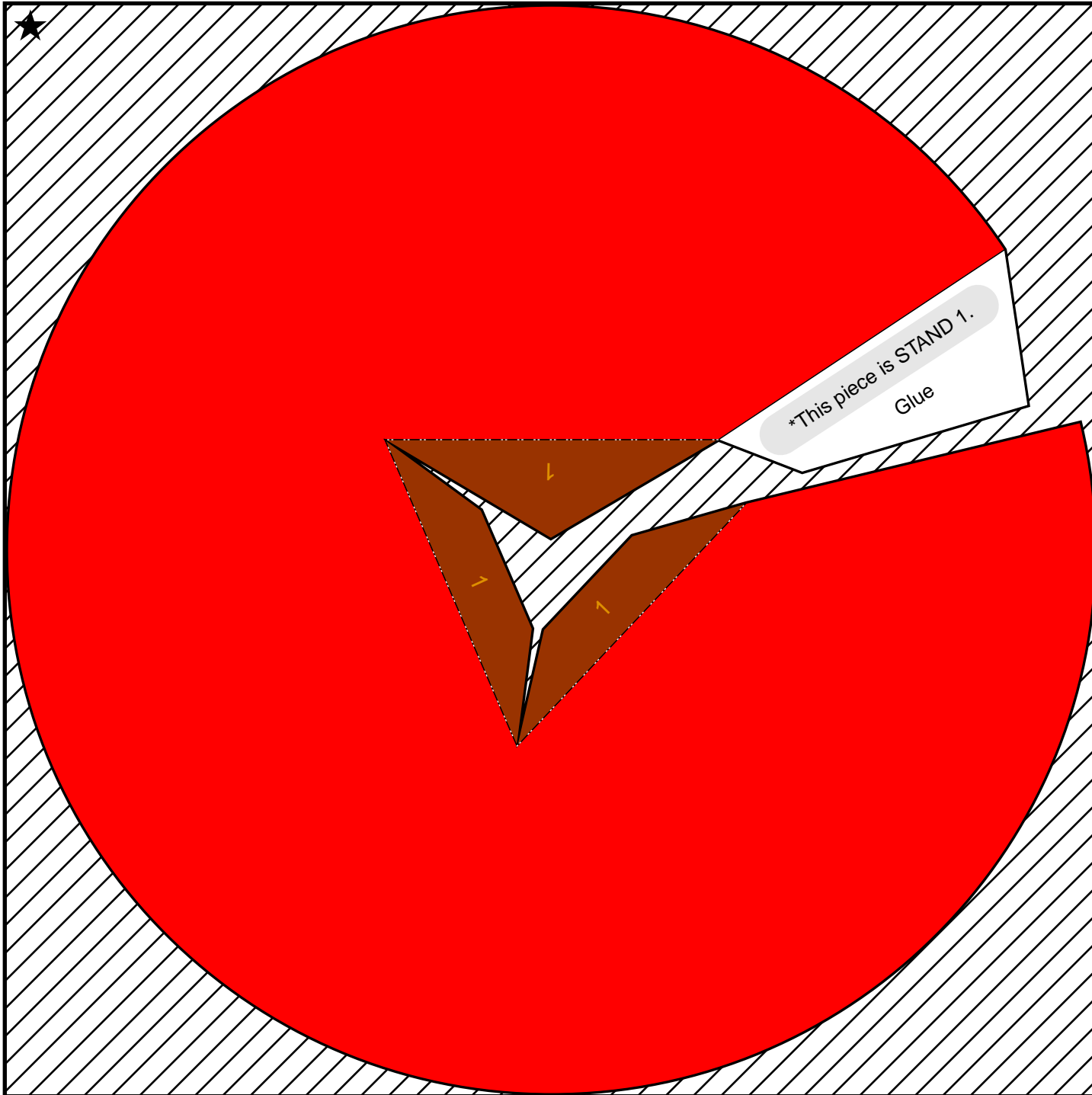

- Cut line
- - - Mountain fold
- · - · - Valley fold

STAND 2

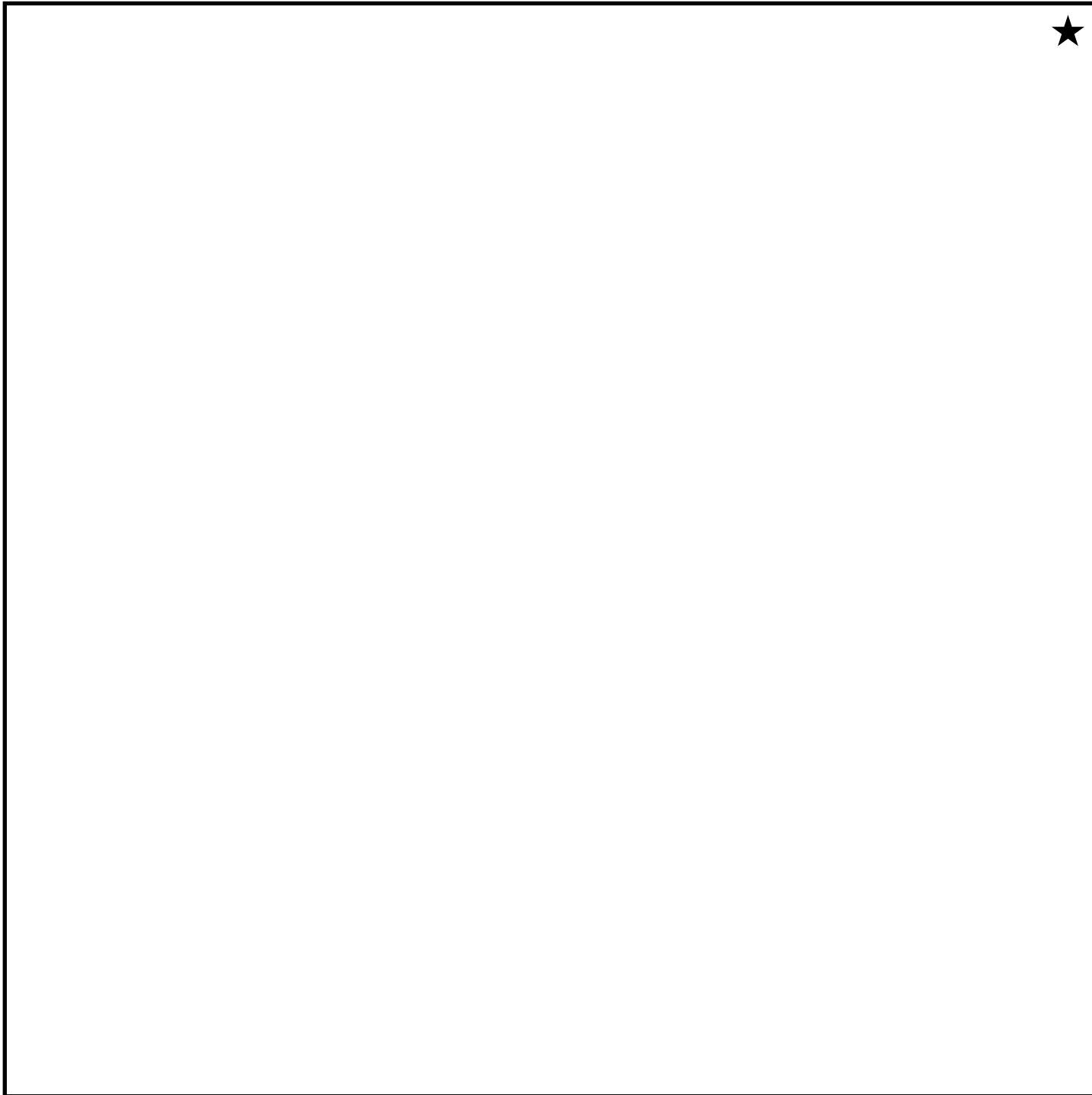

- Cut line
- - - Mountain fold
- · - · - Valley fold

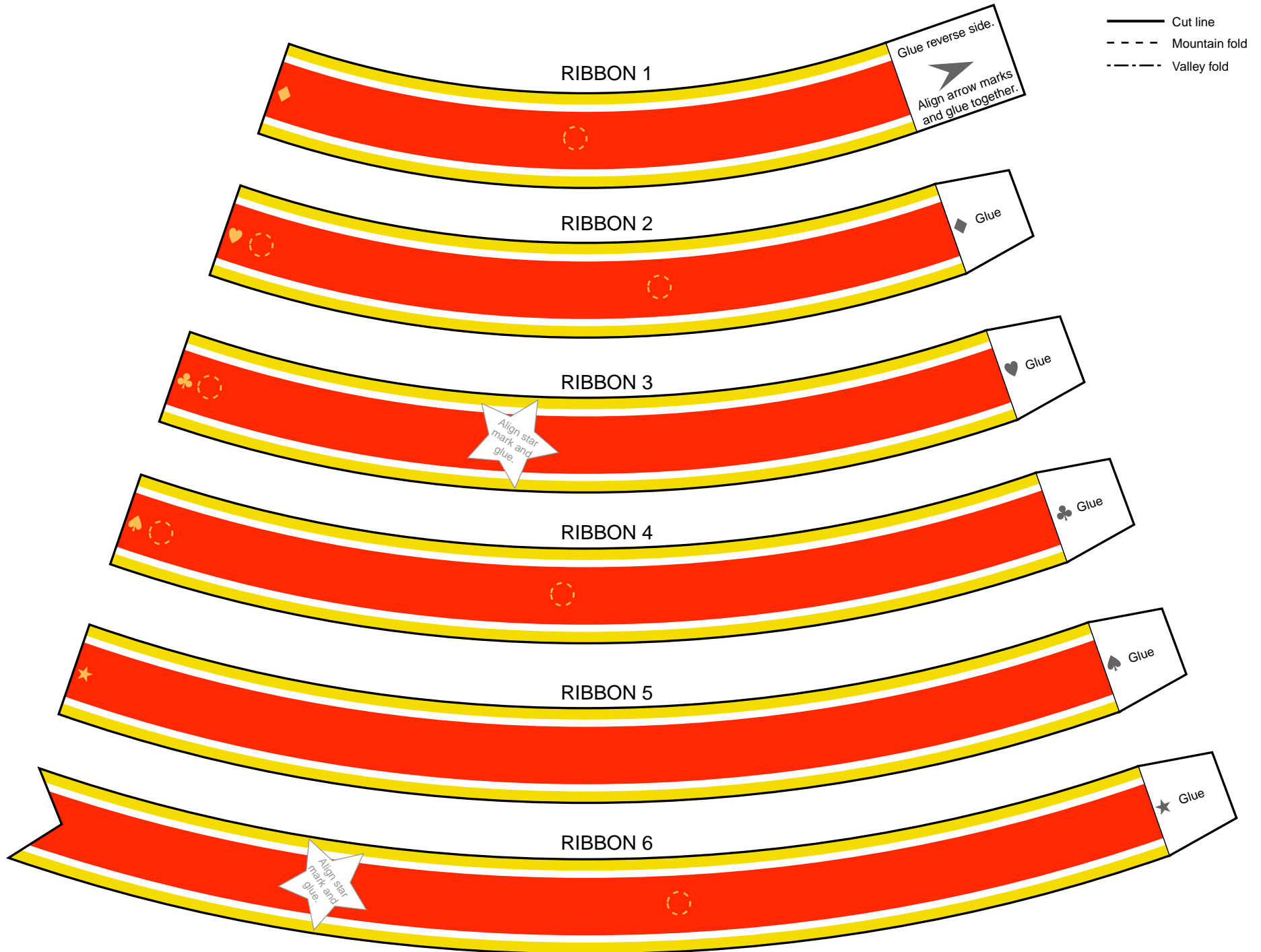

- Cut line
- - - Mountain fold
- - - Valley fold



RIBBON 7



RIBBON 8

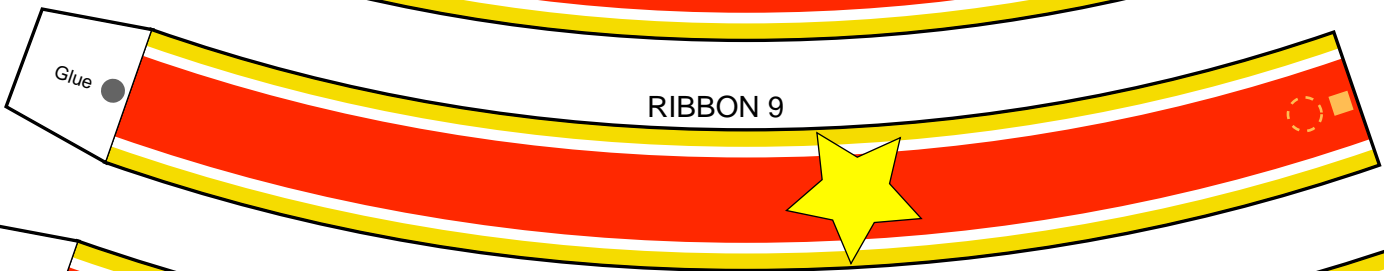

RIBBON 9



RIBBON 10



RIBBON 11



RIBBON 12



CANDY CANE

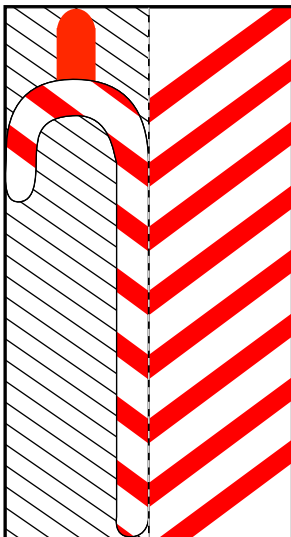

CANDY CANE

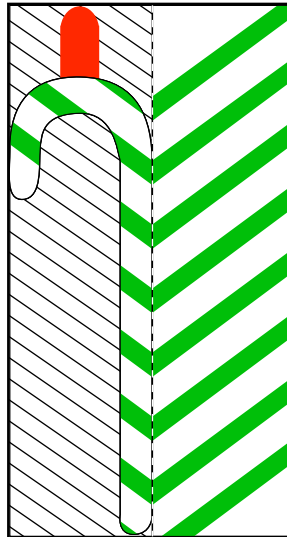

CANDY CANE

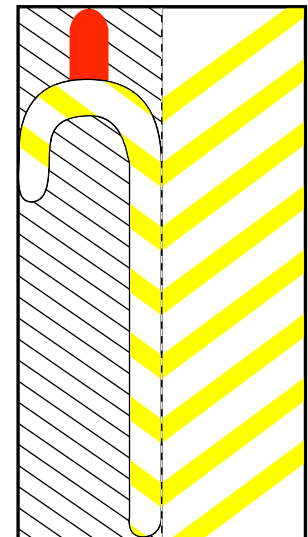

- Cut line
- - - Mountain fold
- · - · - Valley fold

CANDLE

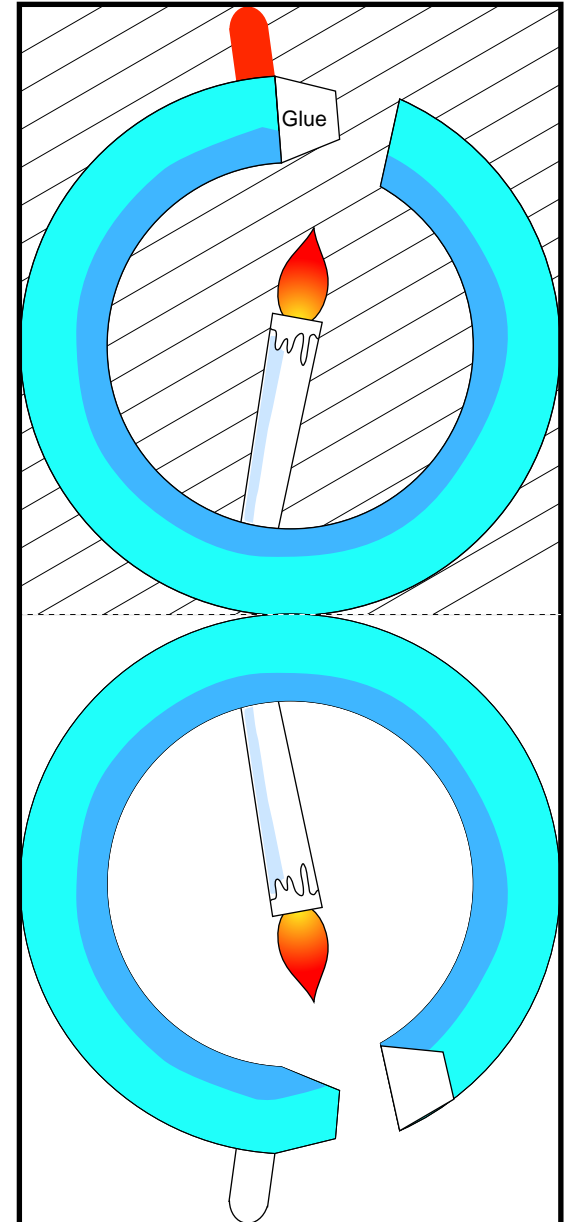
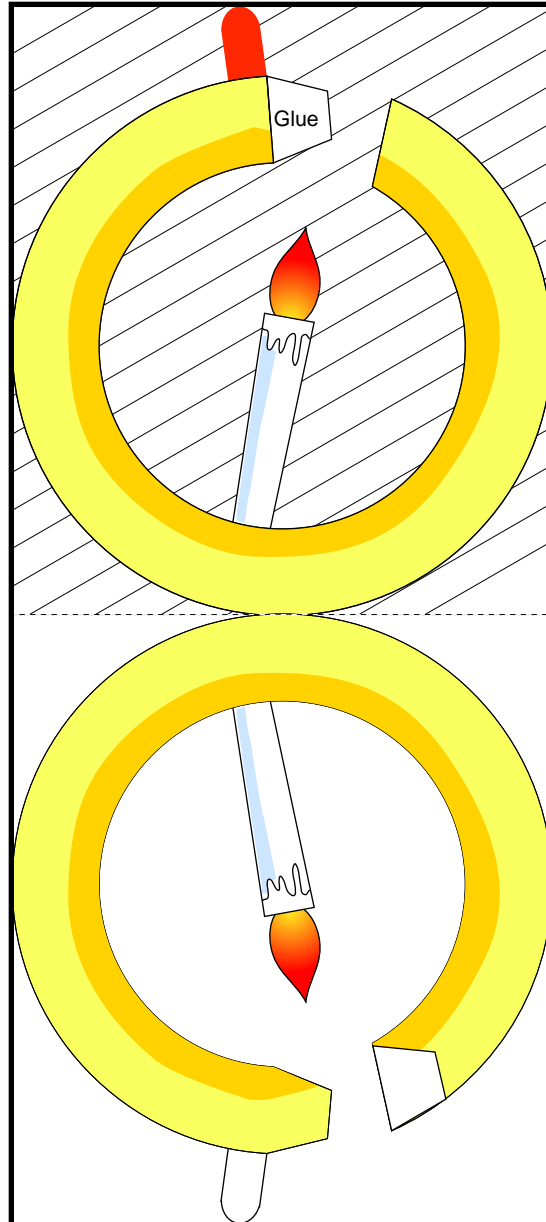
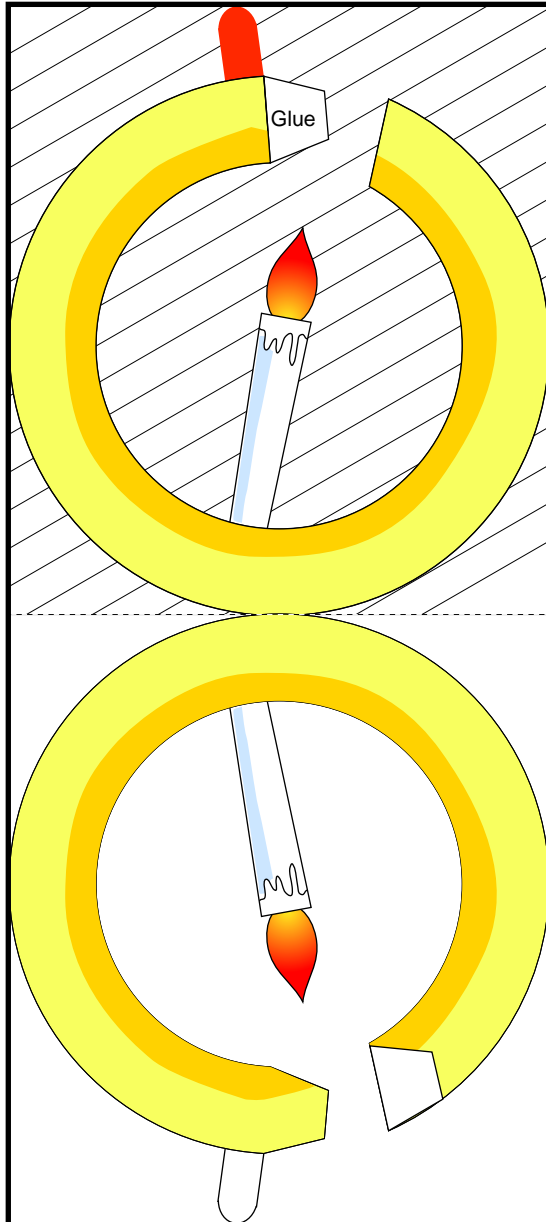

FOLIAGE SUPPORT

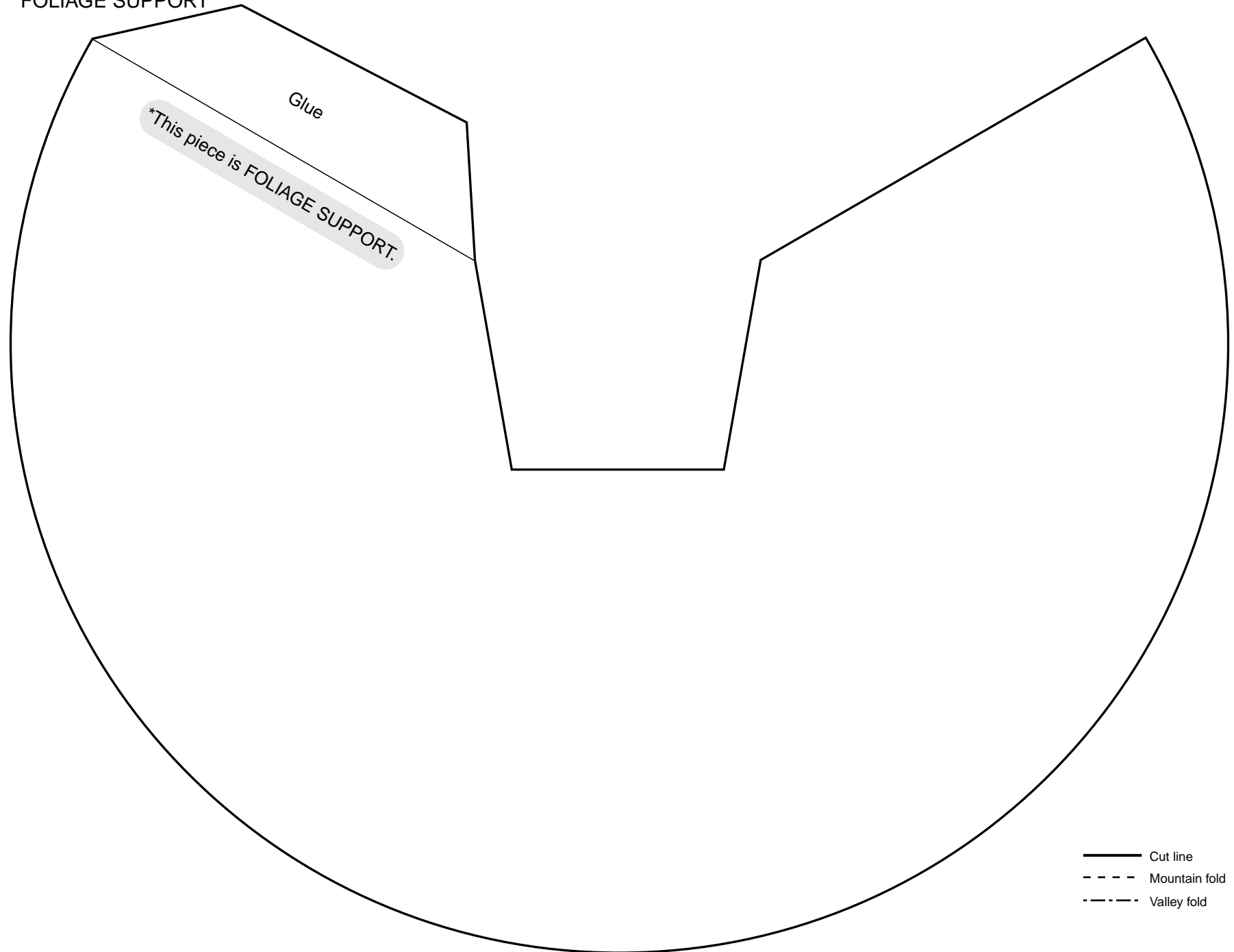

*This piece is FOLIAGE SUPPORT.

Glue

- Cut line
- - - Mountain fold
- · - · - Valley fold