

# 3D PAPER CRAFT

[Seasons & Holidays]

## Christmas Tree



The customs of Christmas as we know it come from the traditional celebration of the birth of Christ, which was combined with the harvest and winter solstice festivals in ancient Rome. From ancient times, the celebration has involved making offerings and decorating with evergreens, as well as exchanging gifts.

The custom of the Christmas tree began in Germany. The evergreens used for the Christmas tree symbolize the eternal life. Early Christmas trees were decorated with apples, paper flowers, candy, and candles. The candles symbolize the stars shining in the sky above the forests. The candy cane came to be decorated from the choir of Germany having given the sugar cane to children as Christmas service. Today, various ornaments are seen on the Christmas trees.

\* This Christmas tree is about 50 cm (20 inches) tall.

### Directions

#### Build the tree FOLIAGE 1

##### FOLIAGE (LEVEL 4)

##### FOLIAGE 11

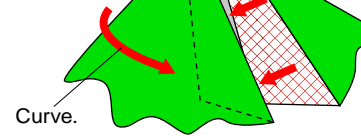

##### FOLIAGE (LEVEL 5)

##### FOLIAGE 12

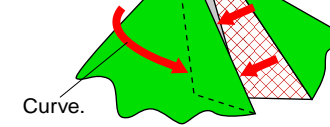

\* For FOLIAGE (LEVELS 3-5), align the letters on the upper parts of the pieces and glue together as shown in the illustrations.

##### FOLIAGE (LEVEL 3)

##### FOLIAGE (LEVEL 2)

##### FOLIAGE 7

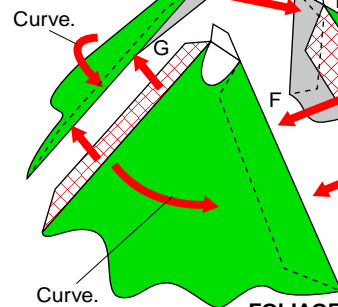

##### FOLIAGE 8

##### FOLIAGE SUPPORT

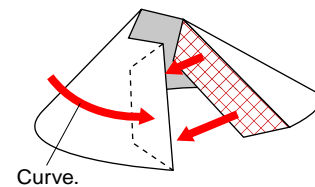

Attaching the FOLIAGE SUPPORT.

##### FOLIAGE (LEVEL 1)

##### FOLIAGE (LEVEL 1)

Align the shape of the hole.

Glue

Glue

##### FOLIAGE 6

##### FOLIAGE 9

##### FOLIAGE 10

##### FOLIAGE (LEVEL 1)

##### FOLIAGE 2

##### FOLIAGE 3

##### FOLIAGE 4

##### FOLIAGE 5

##### FOLIAGE 1

##### FOLIAGE 2

##### FOLIAGE 3

##### FOLIAGE 4

##### FOLIAGE 5

##### FOLIAGE 1

##### FOLIAGE 2

##### FOLIAGE 3

##### FOLIAGE 4

##### FOLIAGE 5

##### FOLIAGE 1

##### FOLIAGE 2

##### FOLIAGE 3

##### FOLIAGE 4

##### FOLIAGE 5

##### FOLIAGE 1

## Directions

### 2 Build the tree STAND

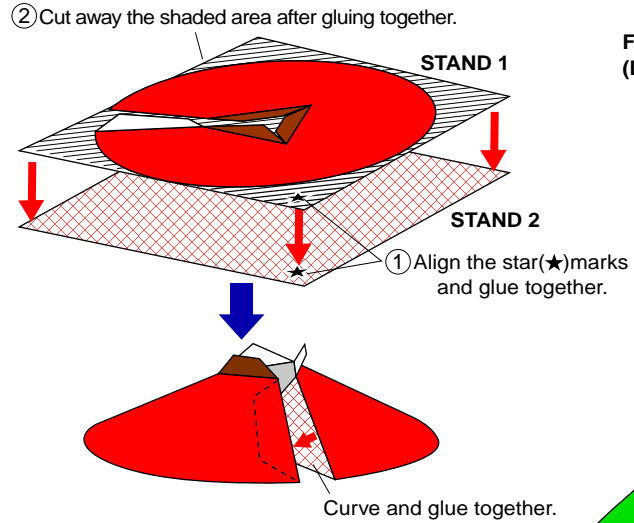

### 3 Build the tree TRUNK

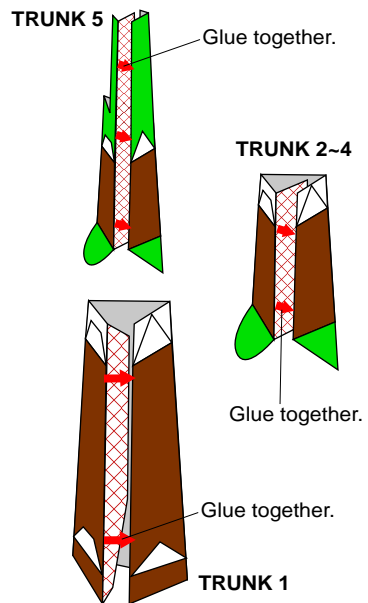

### 4 Attach the FOLIAGE, TRUNKS, and STAND

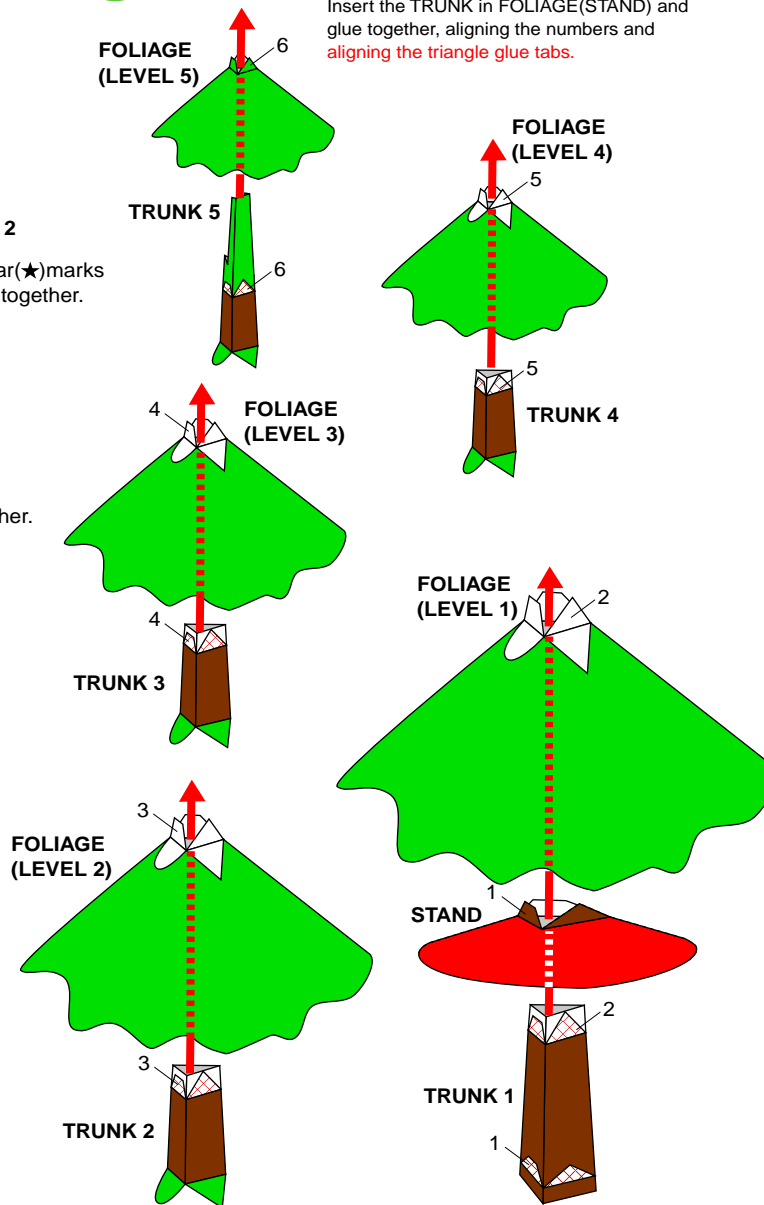

### 5 Build the tree

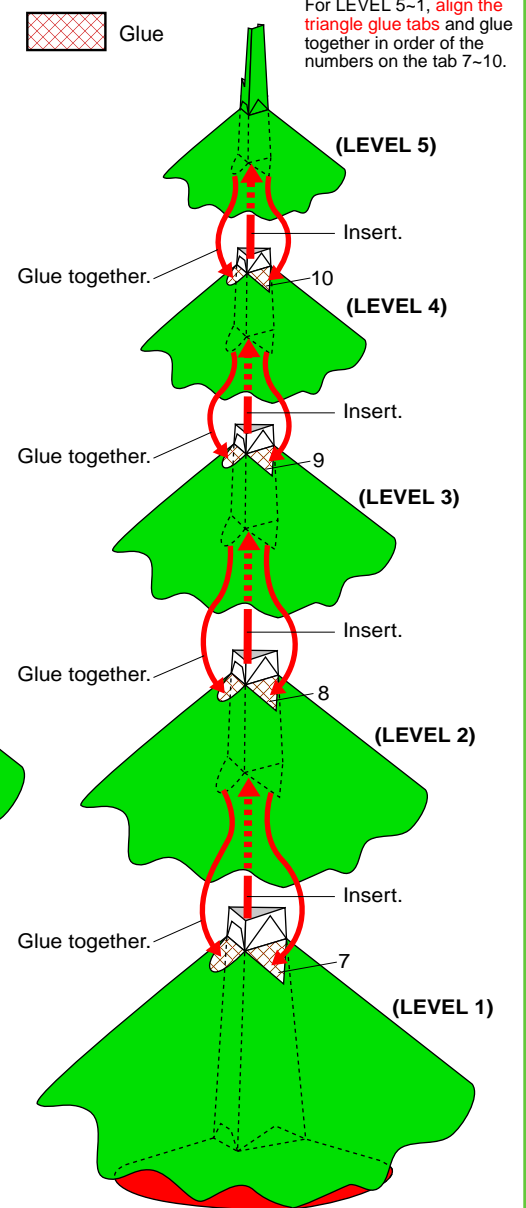

## Directions

### 6 Build the ornaments

#### SANTA CLAUS



Glue together.

#### STAR

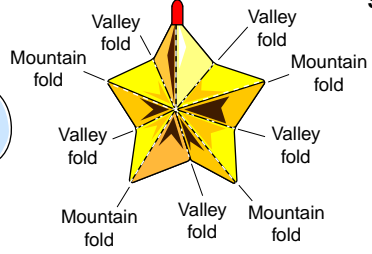

#### PRESENT



Fold along fold lines and glue together.

#### STOCKING



Glue together.

#### BELL

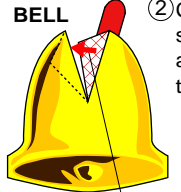

Glue together.

② Cut away the shaded area after gluing together.

#### CANDY CANE

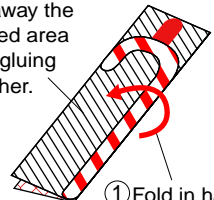

① Fold in half and glue together.

#### CANDLE

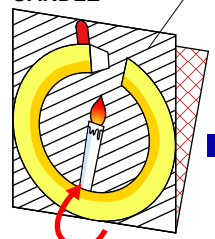

① Fold in half and glue together.

② Cut away the shaded area after gluing together.

Glue together.

### 7 Build the STAR for the top of the tree

#### STAR(FRONT)

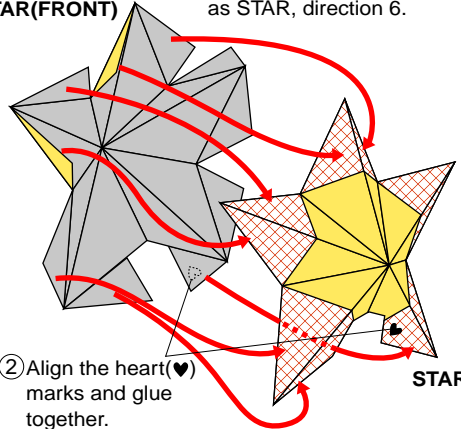

① Fold in the same manner as STAR, direction 6.

② Align the heart(♥) marks and glue together.

#### STAR(BACK)

### 8 Build the RIBBON

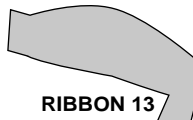

① Wrap around.

Align the arrow(←) marks and glue together.

Glue ornaments to the ◻ marks on the RIBBON.

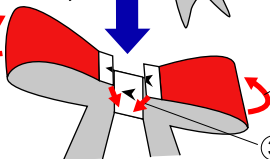

② Curve.

③ Align the arrow(←) marks and glue together.

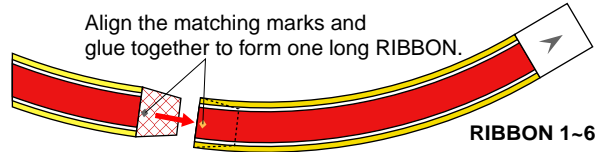

Align the matching marks and glue together to form one long RIBBON.

#### RIBBON 1-6

\* Build RIBBON 7-12 in the same way.

### 9 Decorate the tree with the ornaments



Glue



② Align the marks and glue the RIBBON.

⑥ Place the STAR on the top of the tree.

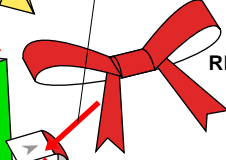

#### RIBBON 13

#### RIBBON 1-6

#### RIBBON 7-12

① Align the marks and glue together.

⑤ Align the star(★)marks and glue the BELL.



#### BELL

③ Align the star(★)marks and glue.



\* You may glue the ornaments to the ◻ marks on the RIBBON, or to the tree FOLIAGE if you prefer. Refer to the illustration on page 1 for one example.

④ Align the star(★)marks and glue.

TRUNK 1

- Cut line
- - - Mountain fold
- · - · Valley fold

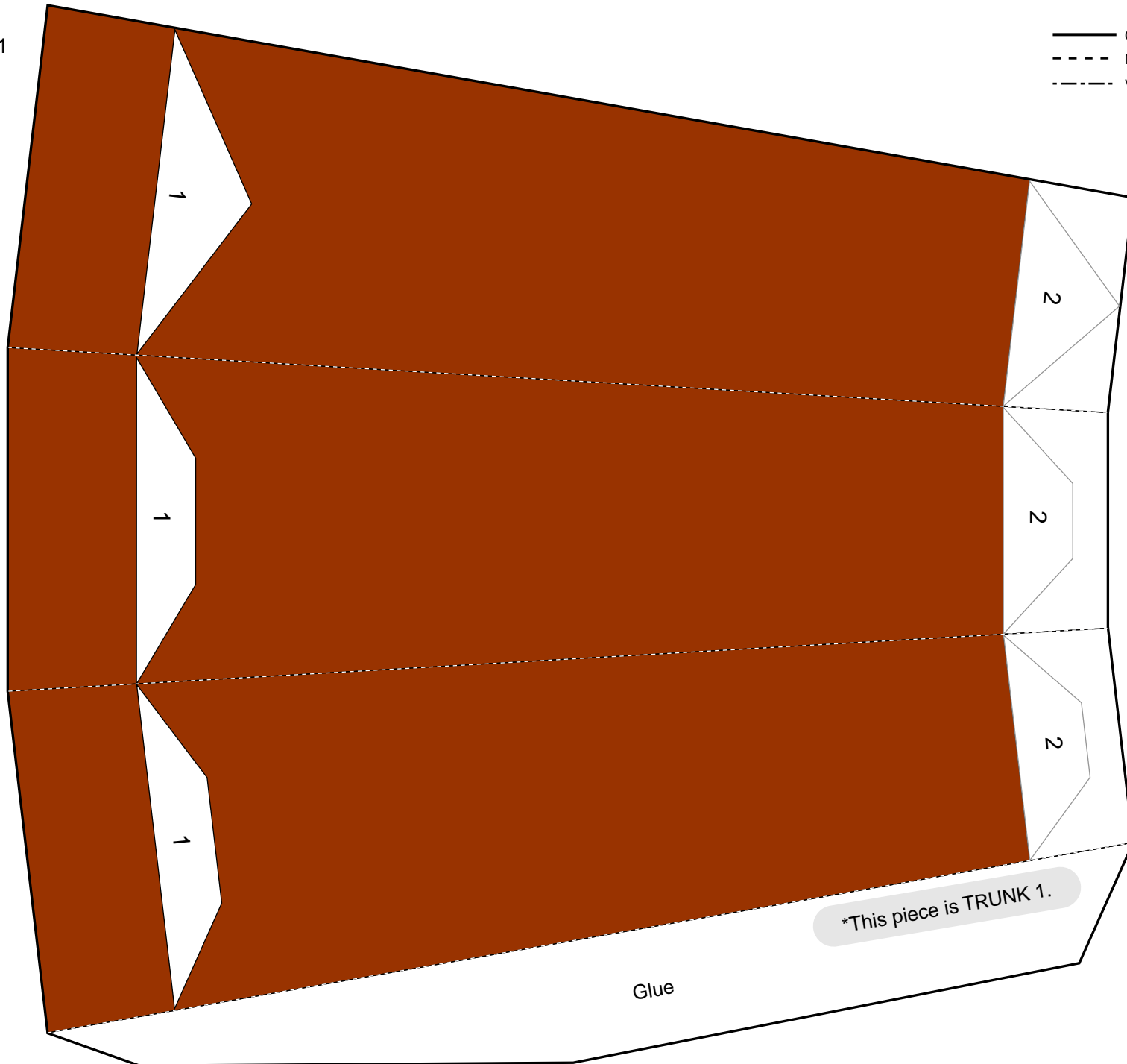

Glue

\*This piece is TRUNK 1.

TRUNK 2



TRUNK 4

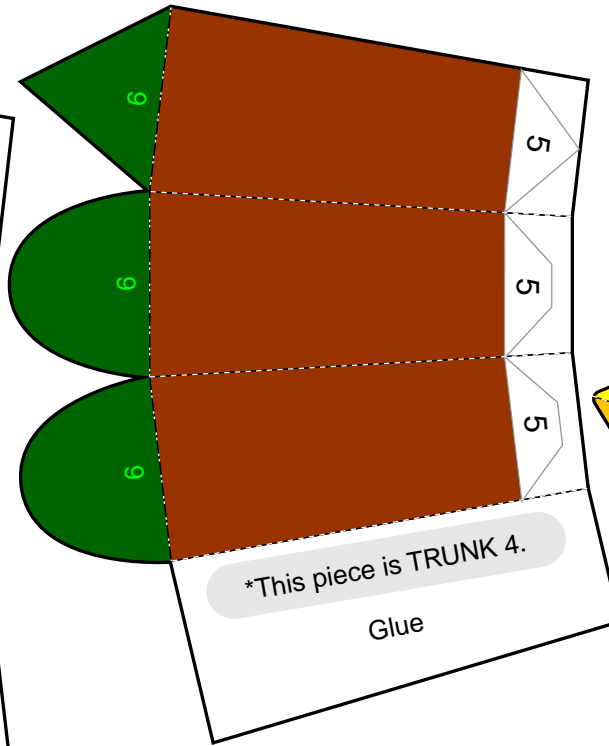

- Cut line
- - - Mountain fold
- - - Valley fold

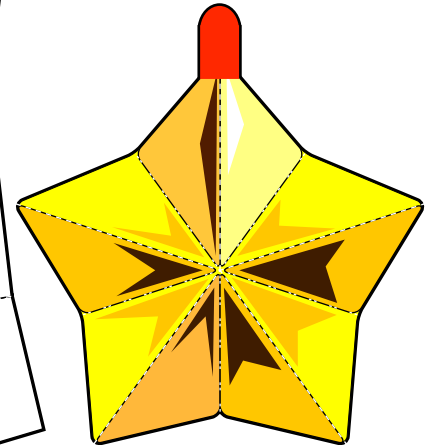

STAR

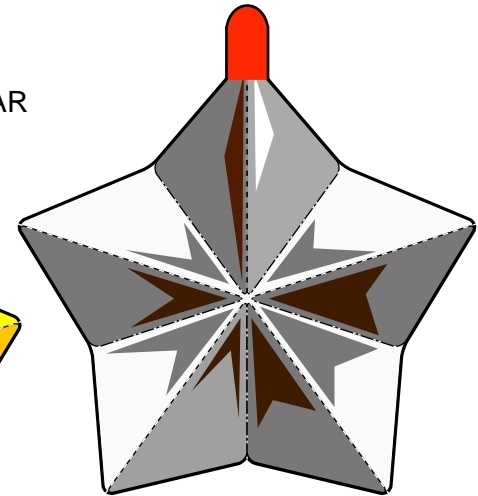
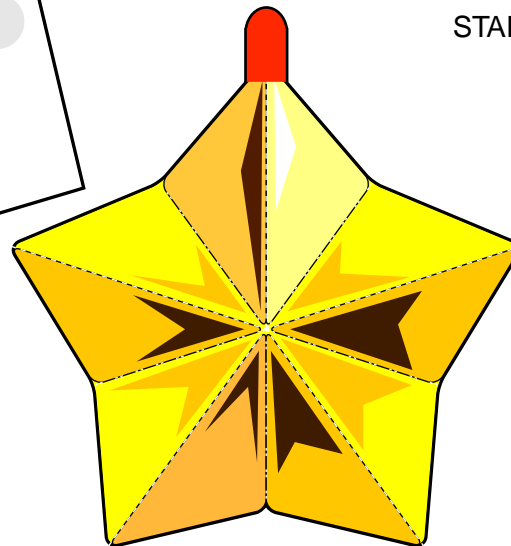

TRUNK 3

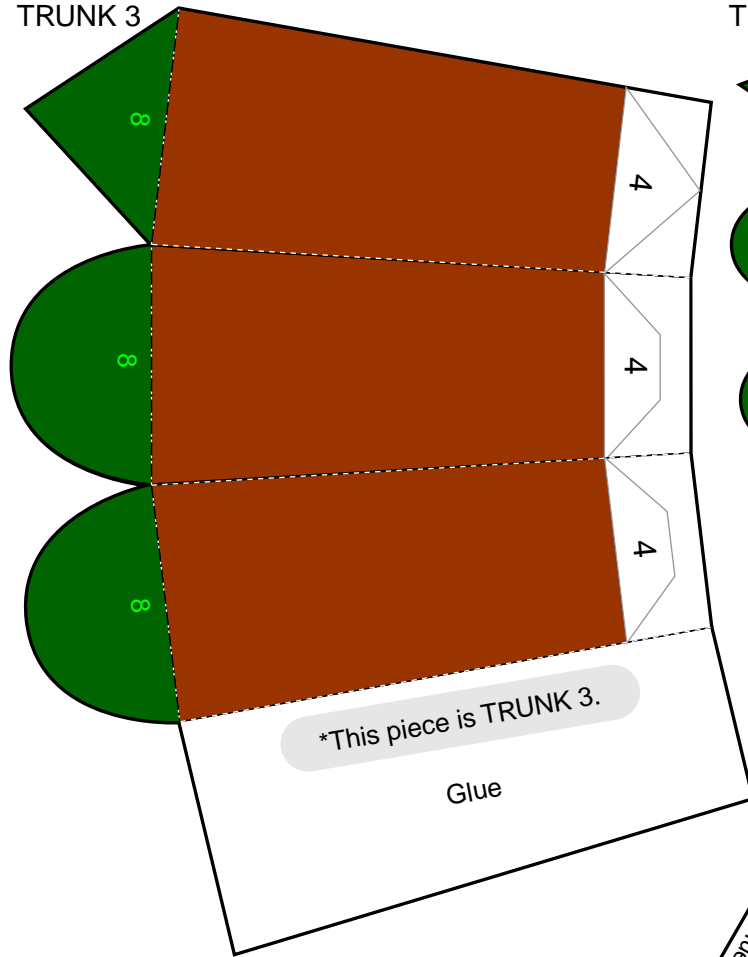

TRUNK 5

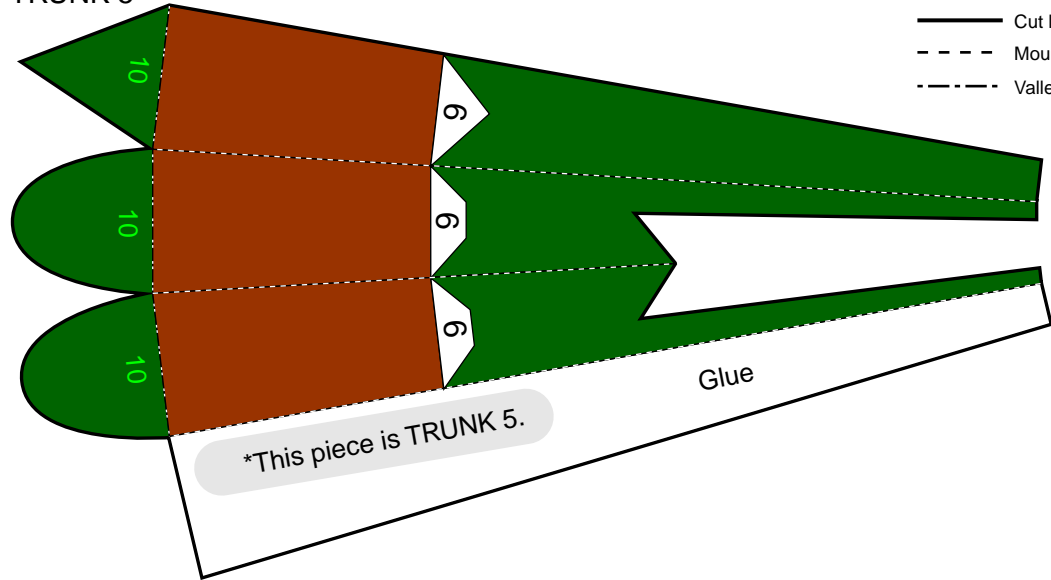

- Cut line
- - - Mountain fold
- · - · - Valley fold

STAR(BACK)  
-for the top

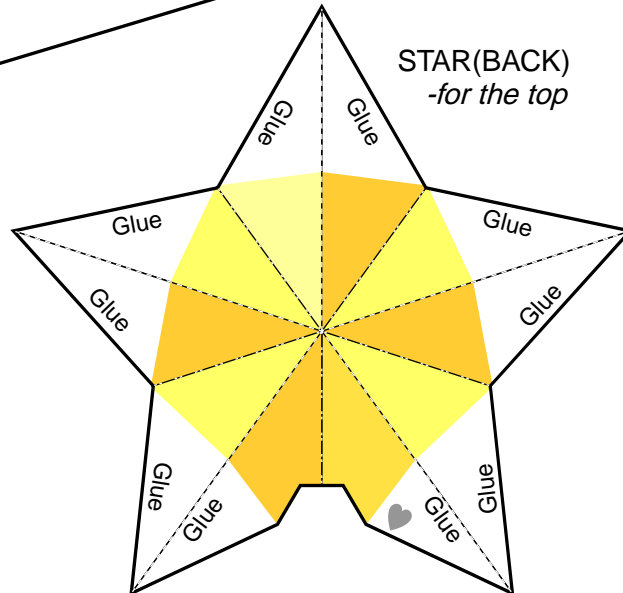

STAR(FRONT)  
-for the top

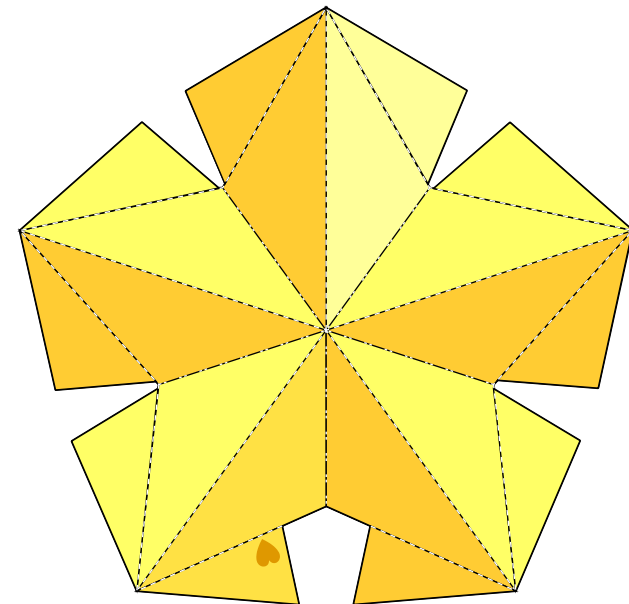



STOCKING

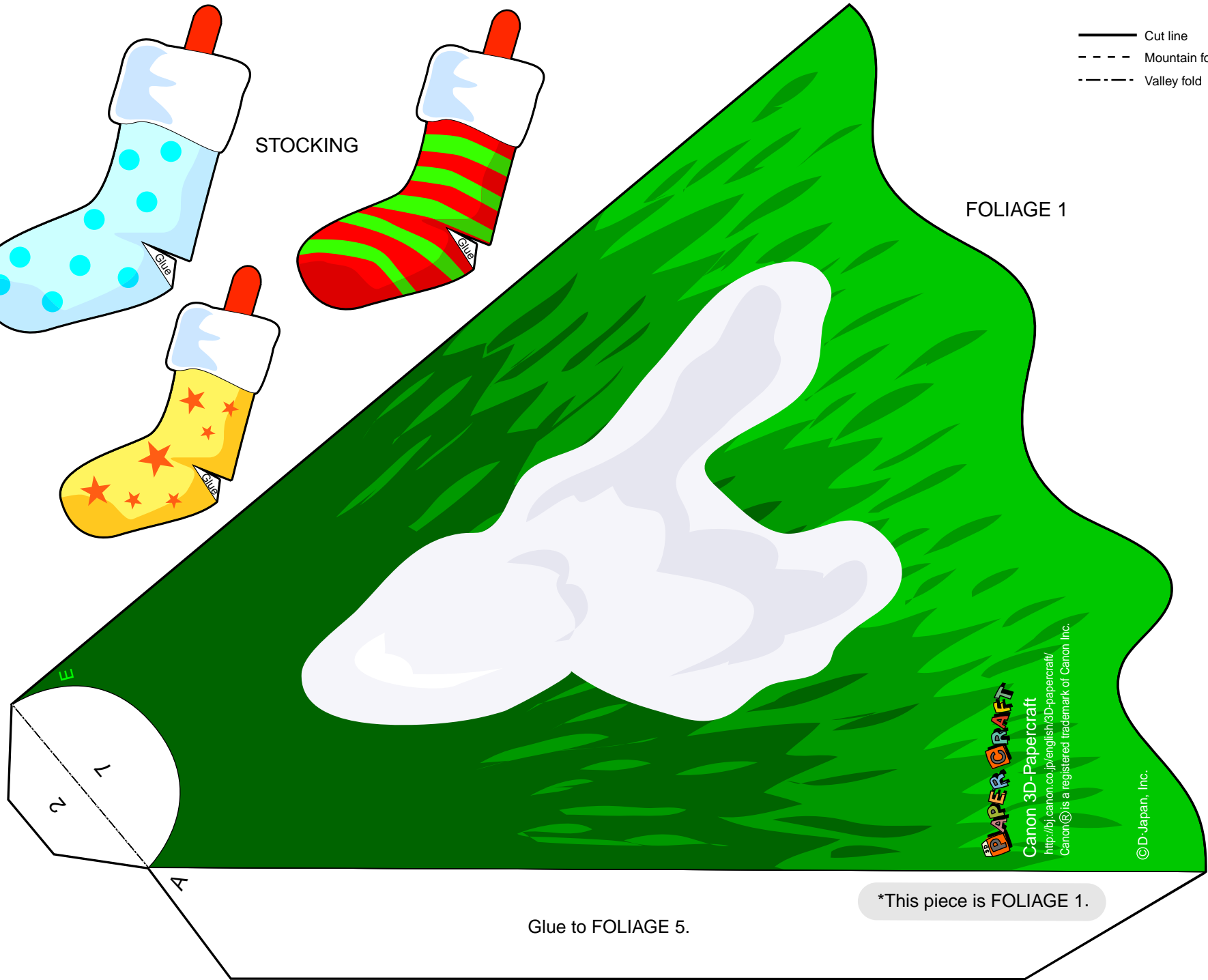

FOLIAGE 1

- Cut line
- - - Mountain fold
- · - Valley fold

**3D PAPER CRAFT**  
Canon 3D-Papercraft  
<http://bj.canon.co.jp/english/3d-papercraft/>  
Canon® is a registered trademark of Canon Inc.  
© D-Japan, Inc.

Glue to FOLIAGE 5.

\*This piece is FOLIAGE 1.

- Cut line
- - - Mountain fold
- · - · Valley fold

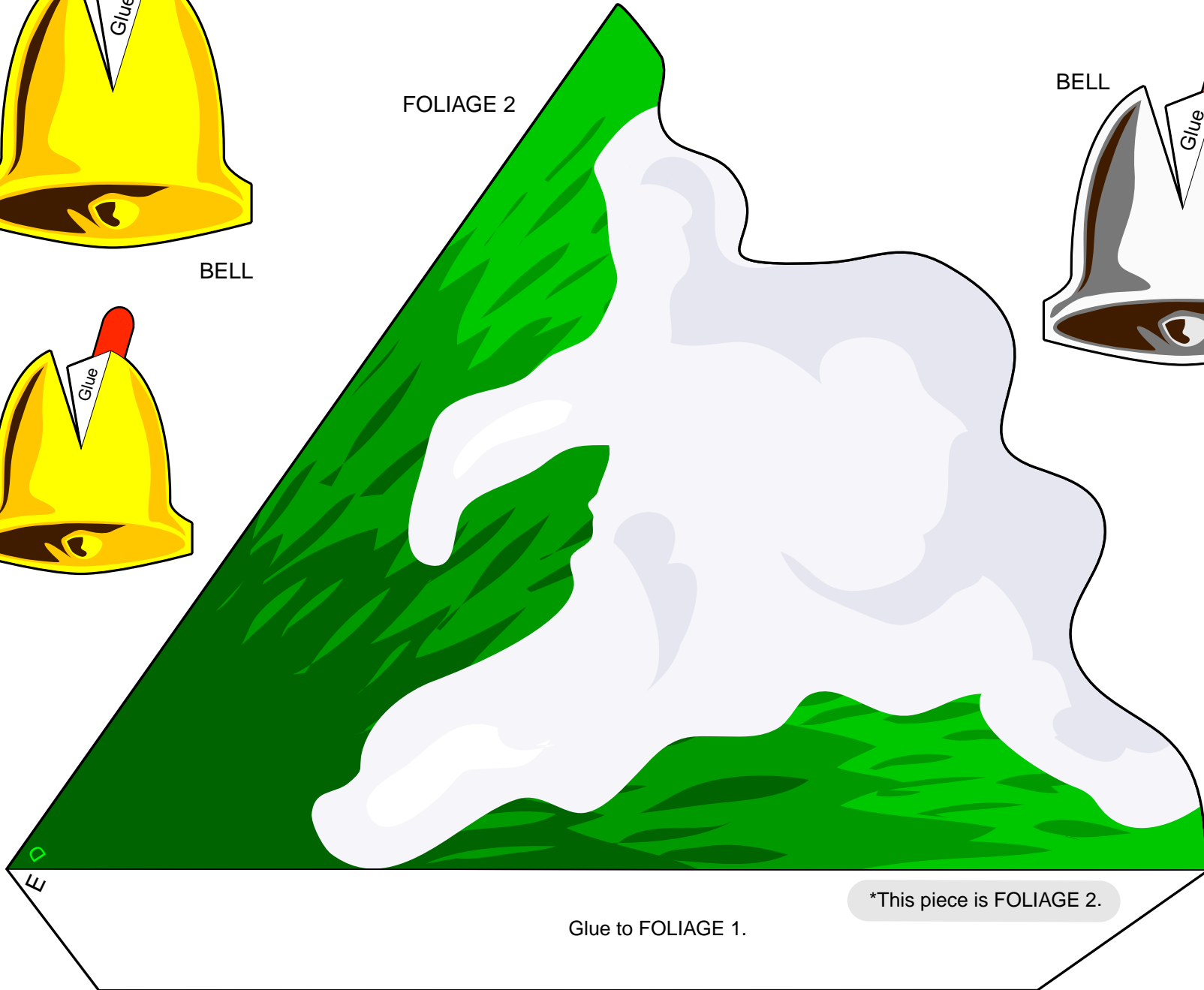
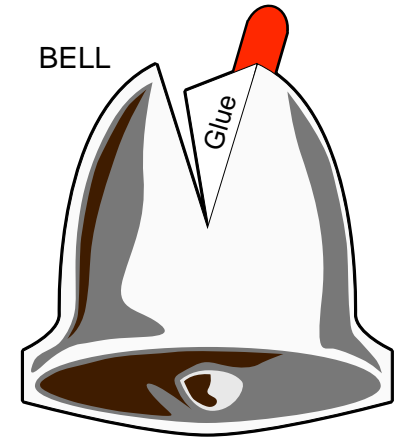
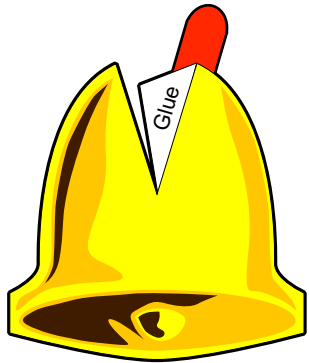
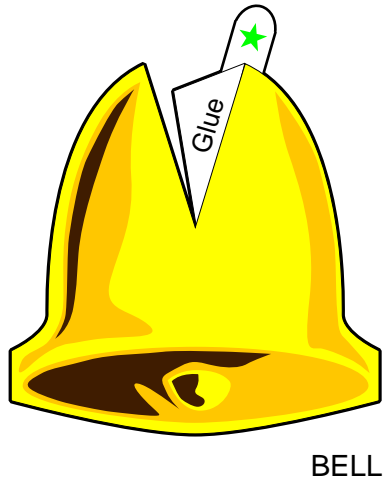

\*This piece is FOLIAGE 2.



- Cut line
- - - Mountain fold
- · - · - Valley fold

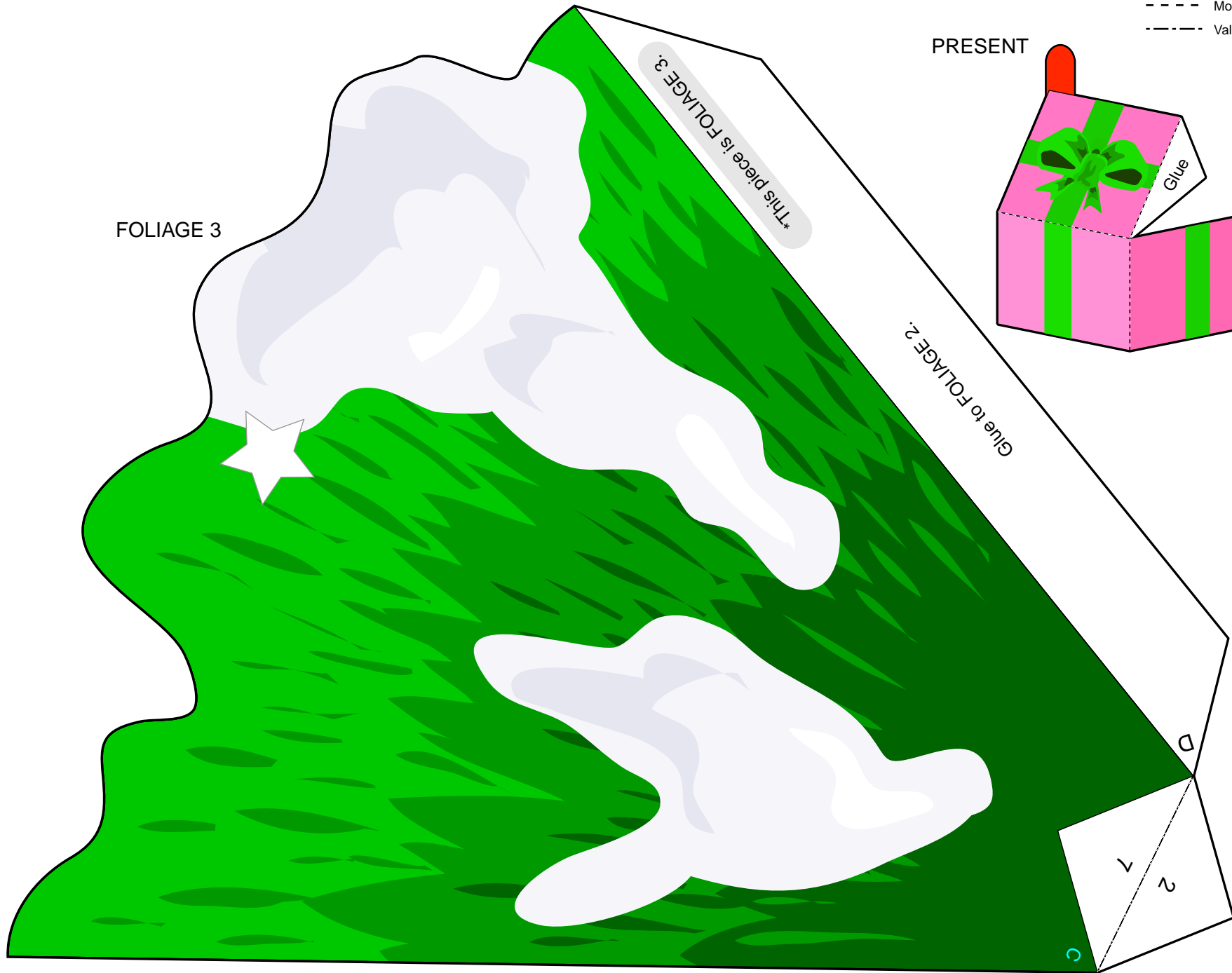

FOLIAGE 3

\*This piece is FOLIAGE 3.\*

Glue to FOLIAGE 2.

PRESENT

Glue

1  
2

C

D

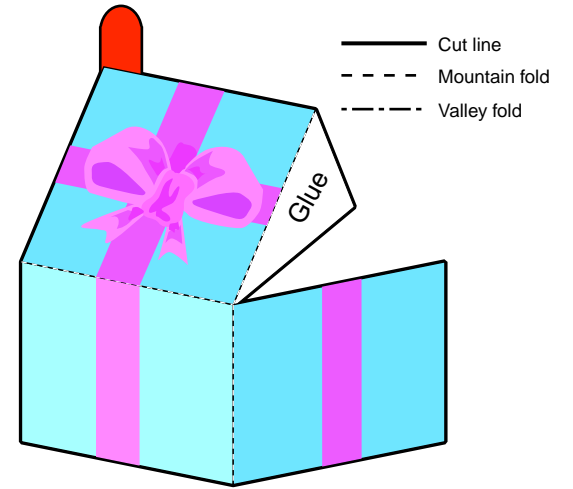

- Cut line
- - - Mountain fold
- · - · - Valley fold



FOLIAGE 4

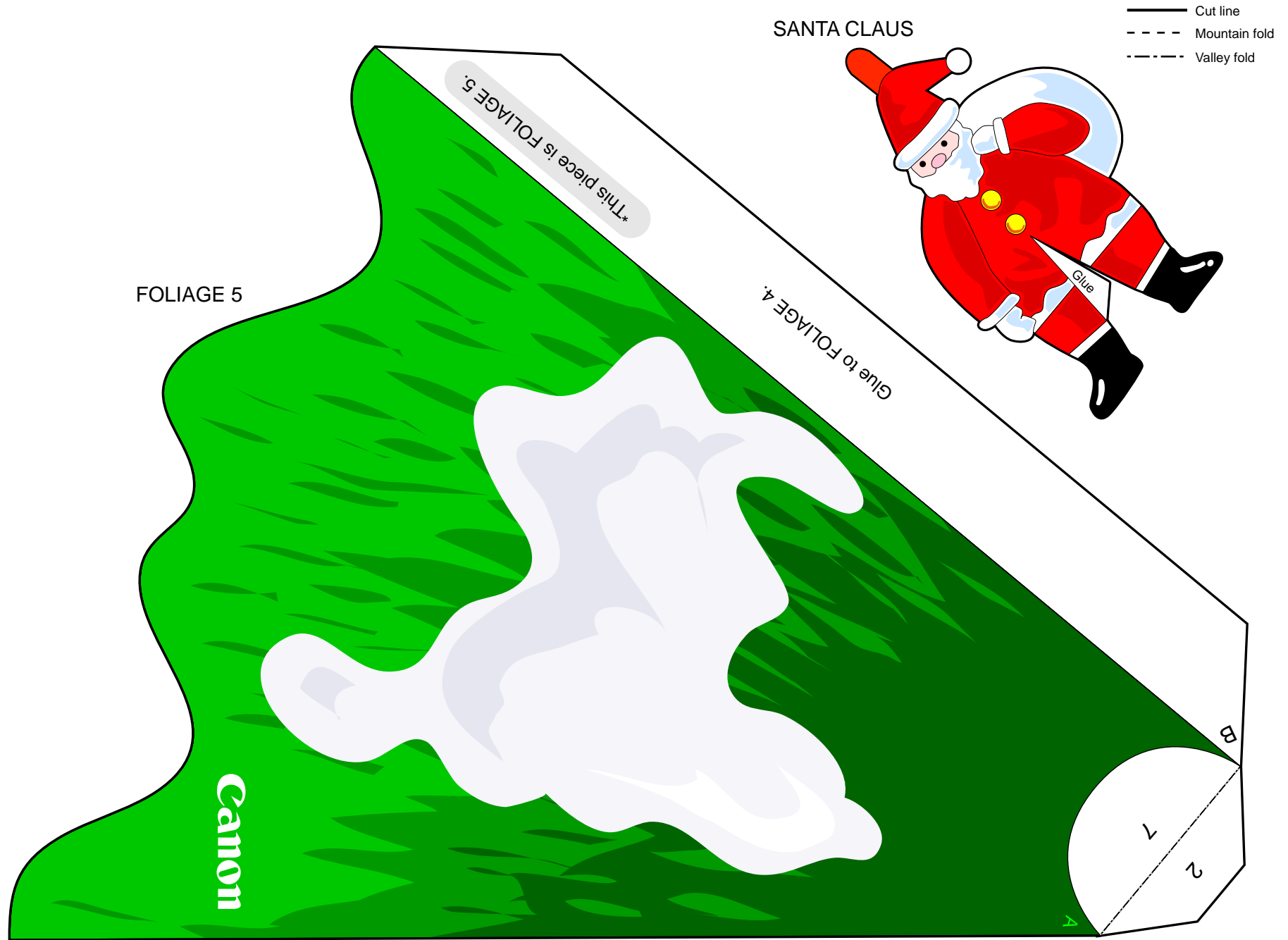

- Cut line
- - - Mountain fold
- · - · - Valley fold

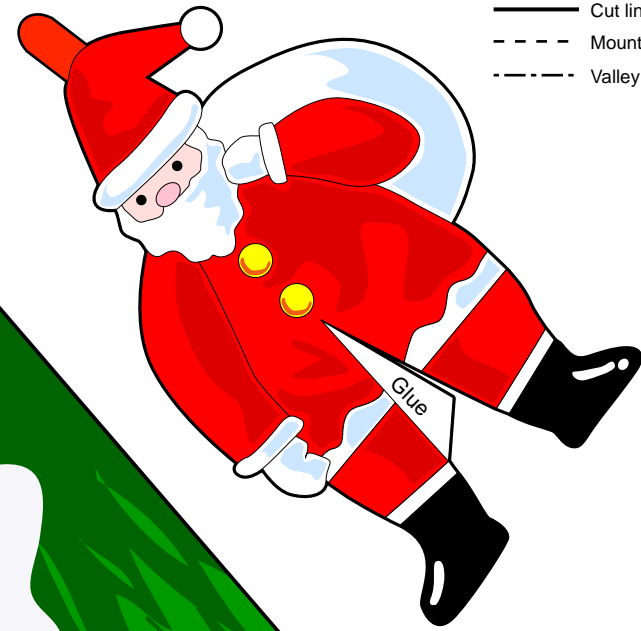
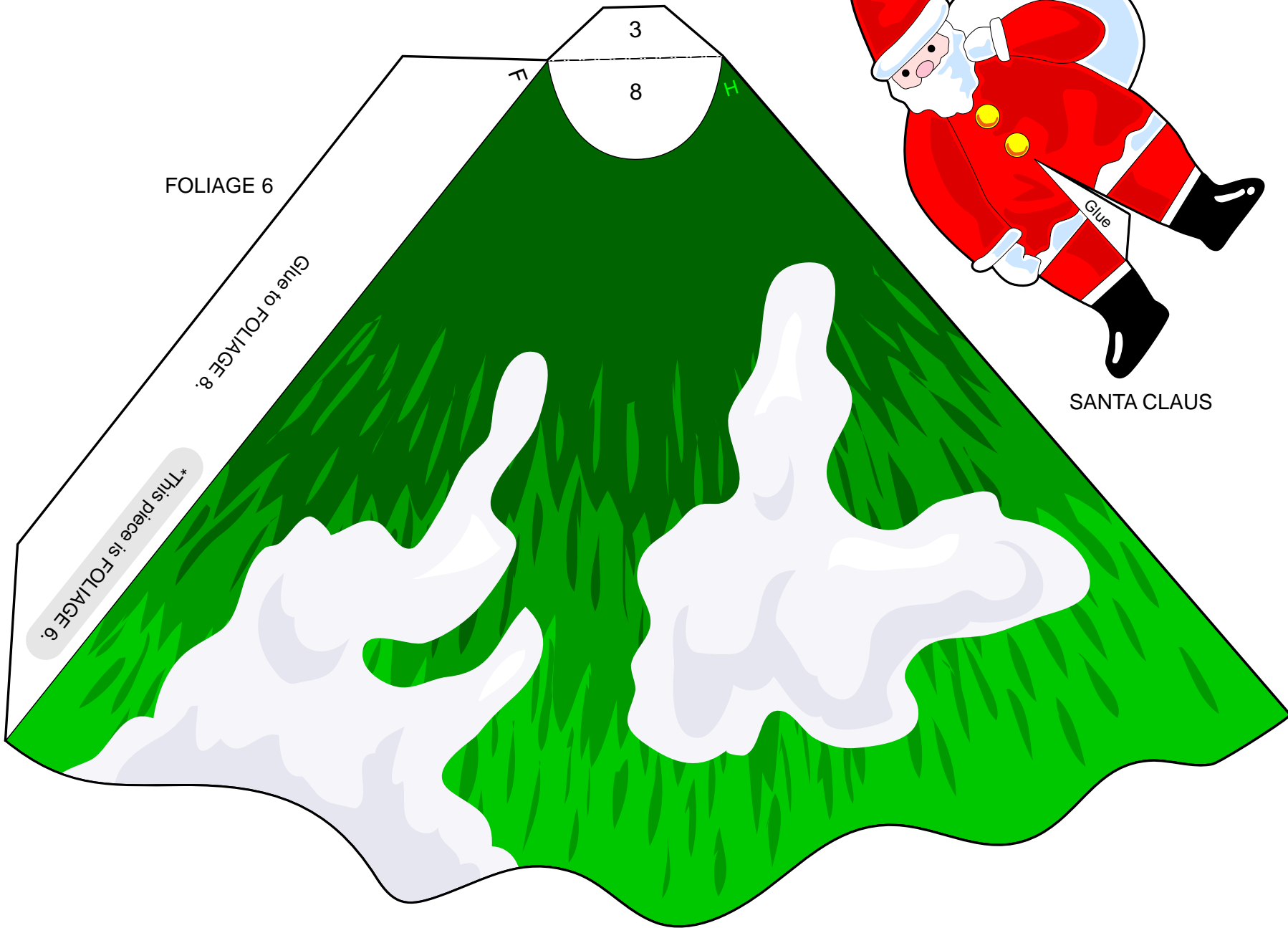

SANTA CLAUS

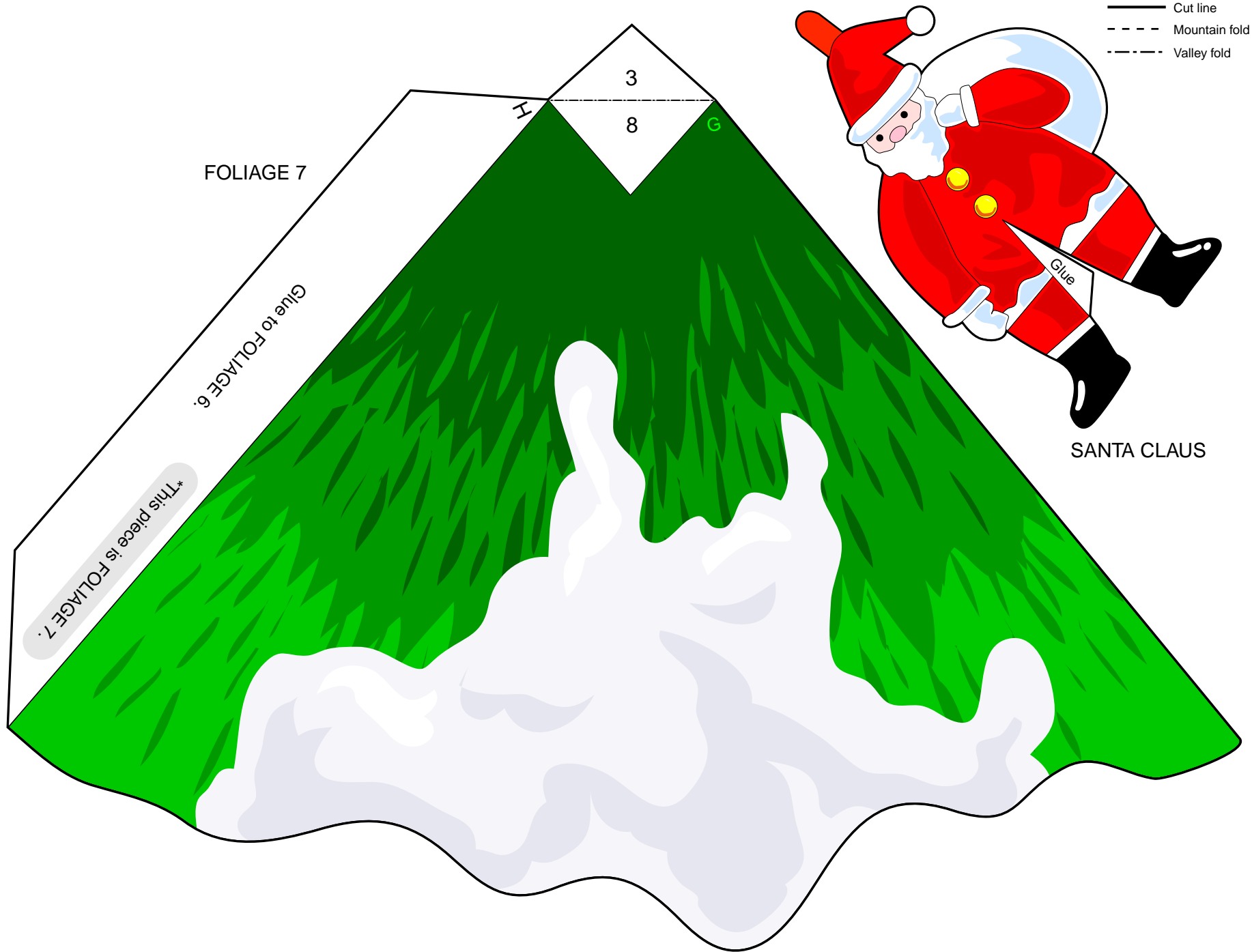

- Cut line
- - - Mountain fold
- · - · Valley fold

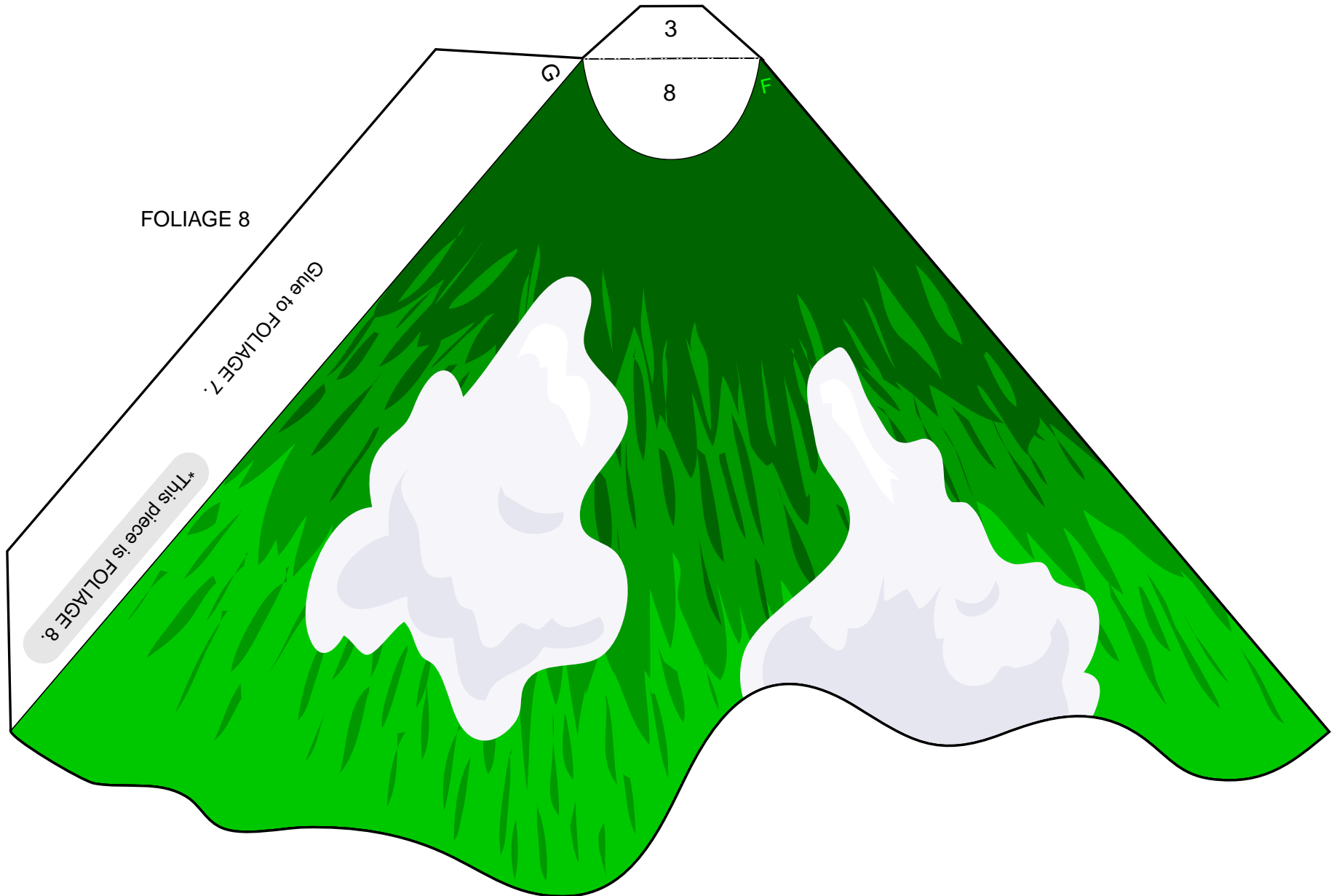

- Cut line
- - - Mountain fold
- · - · - Valley fold

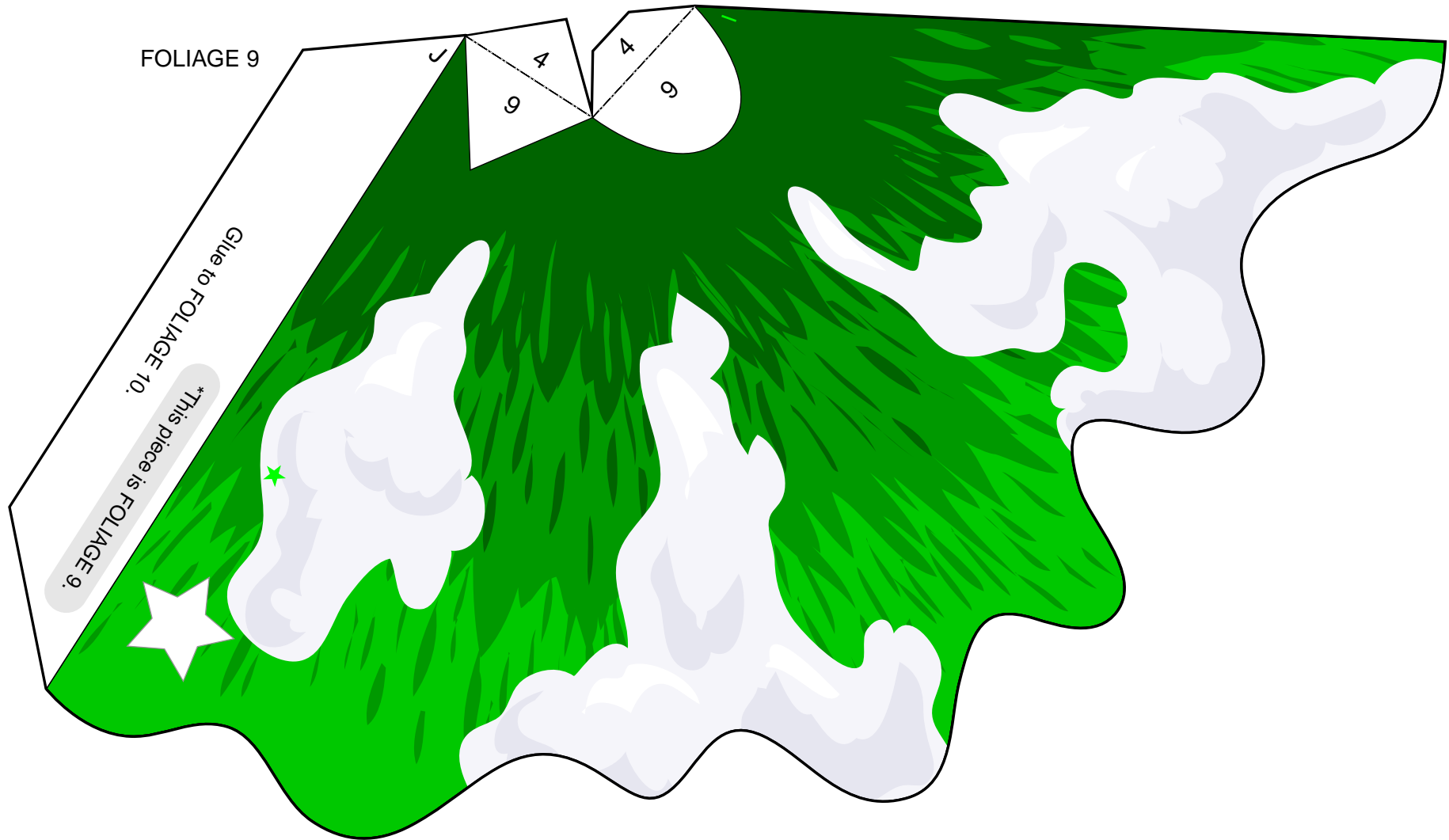

- Cut line
- - - Mountain fold
- · - · Valley fold

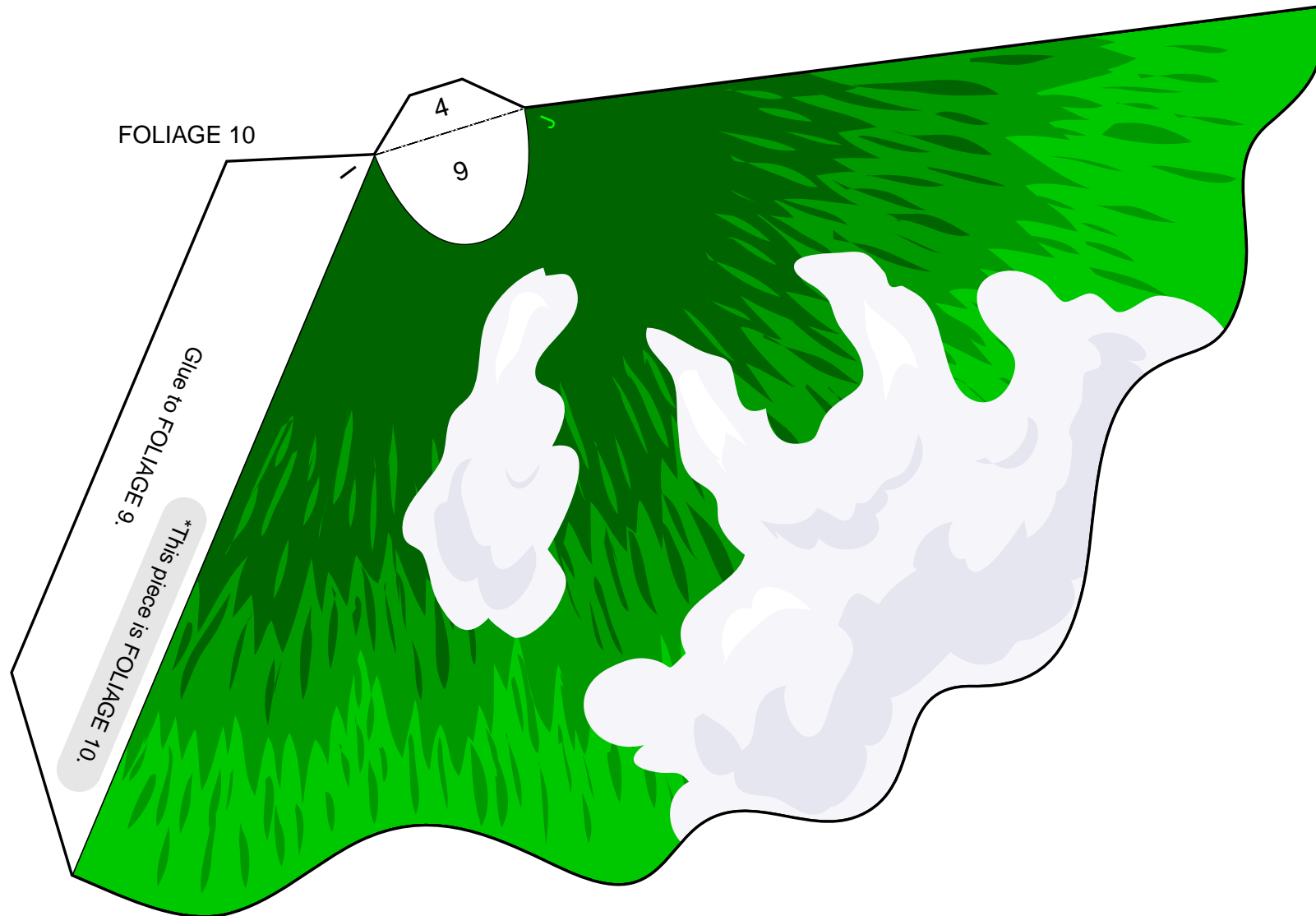



- Cut line
- - - Mountain fold
- · - · Valley fold

FOLIAGE 11

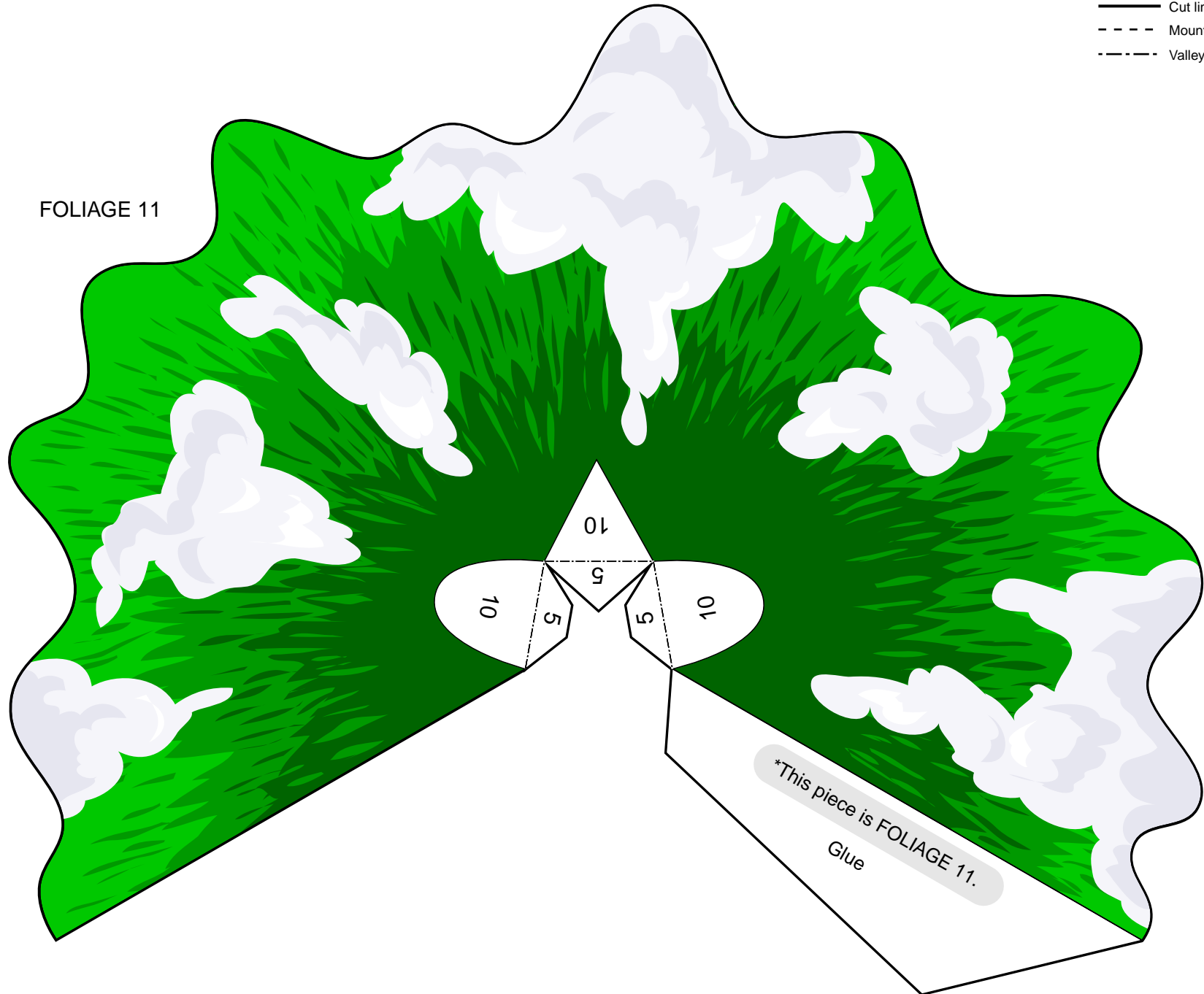

- Cut line
- - - Mountain fold
- - - - Valley fold



STAND 1

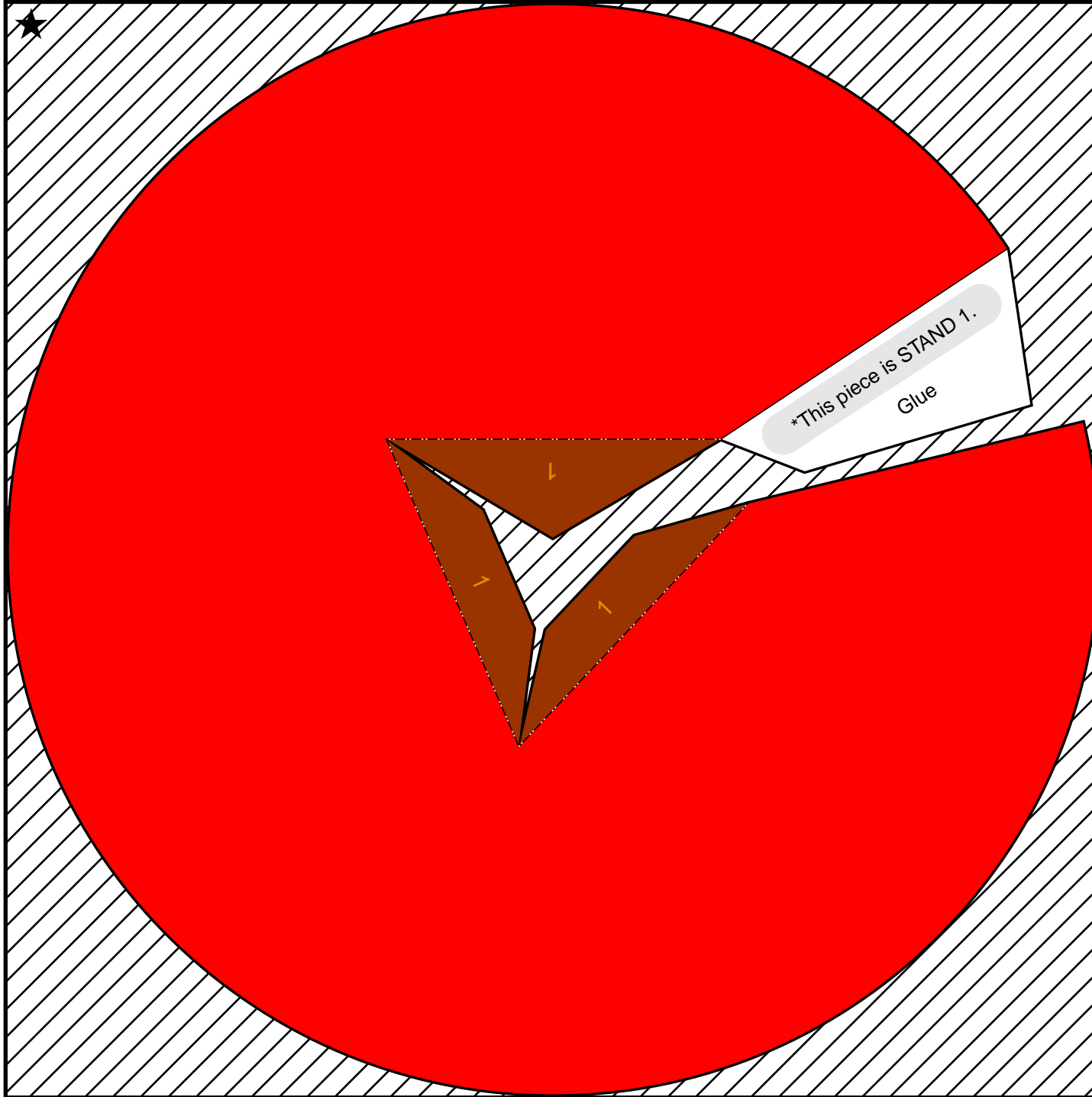

- Cut line
- - - Mountain fold
- · - · - Valley fold

STAND 2

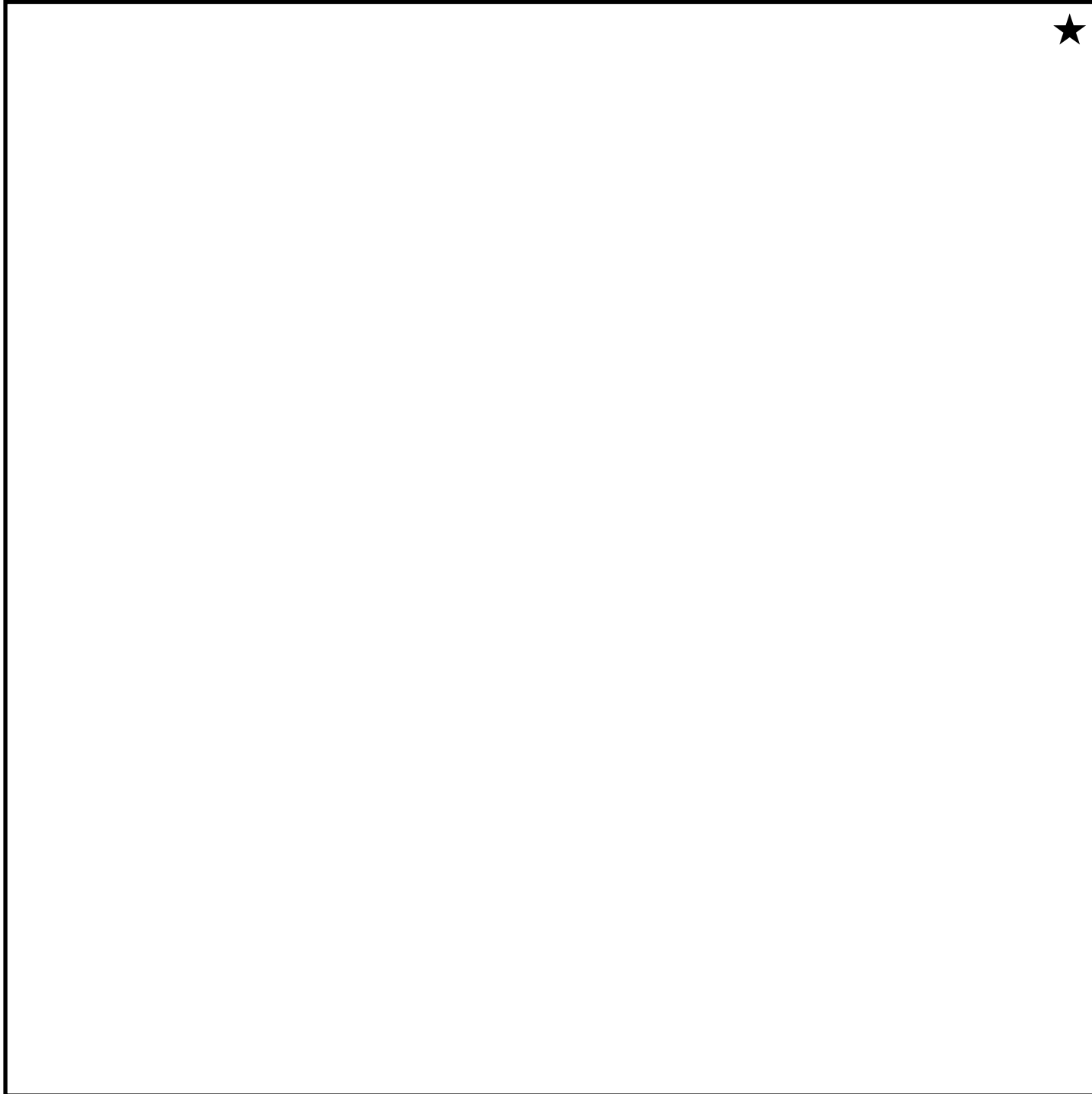

- Cut line
- - - Mountain fold
- · - · - Valley fold

- Cut line
- - - Mountain fold
- · - · - Valley fold

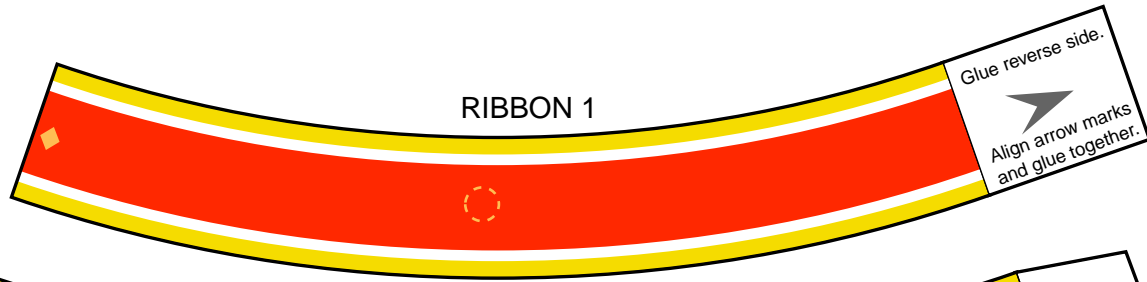

- Cut line
- - - Mountain fold
- · - · - Valley fold

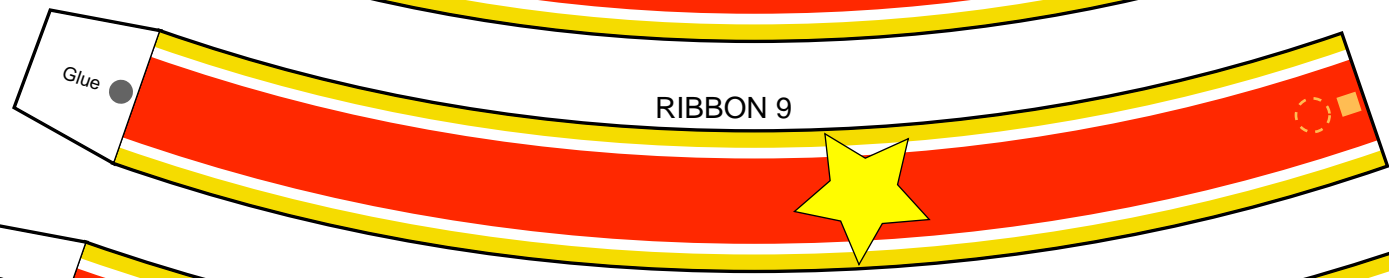
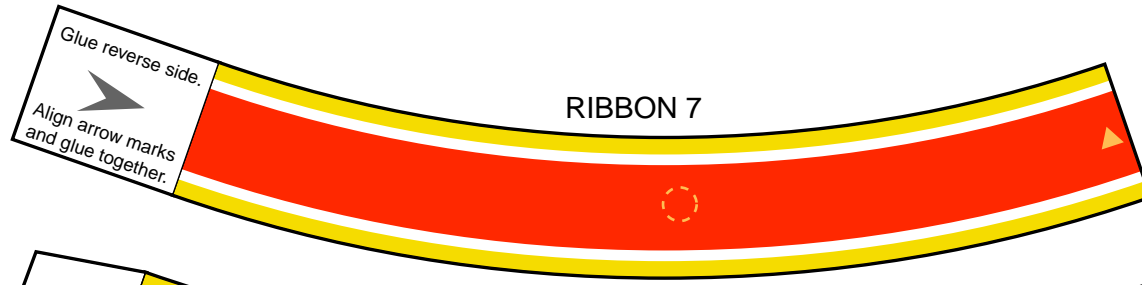

- Cut line
- - - Mountain fold
- · - · - Valley fold



CANDY CANE

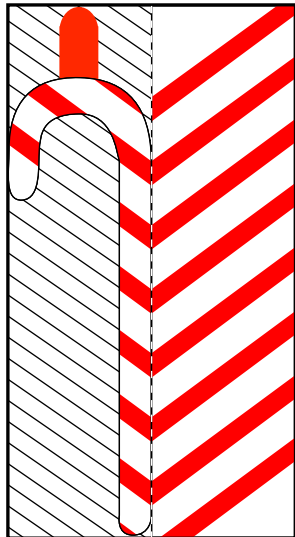

CANDY CANE

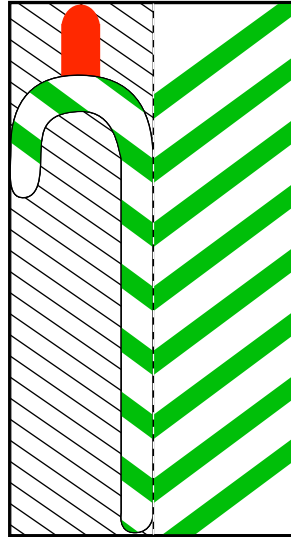

CANDY CANE

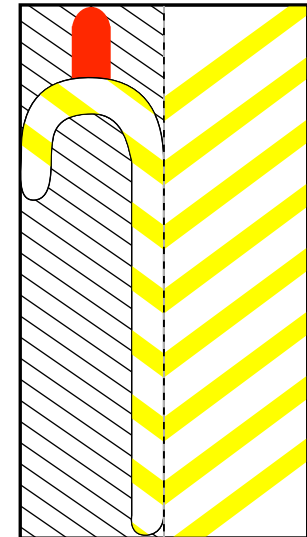

- Cut line
- - - Mountain fold
- · - · - Valley fold

CANDLE

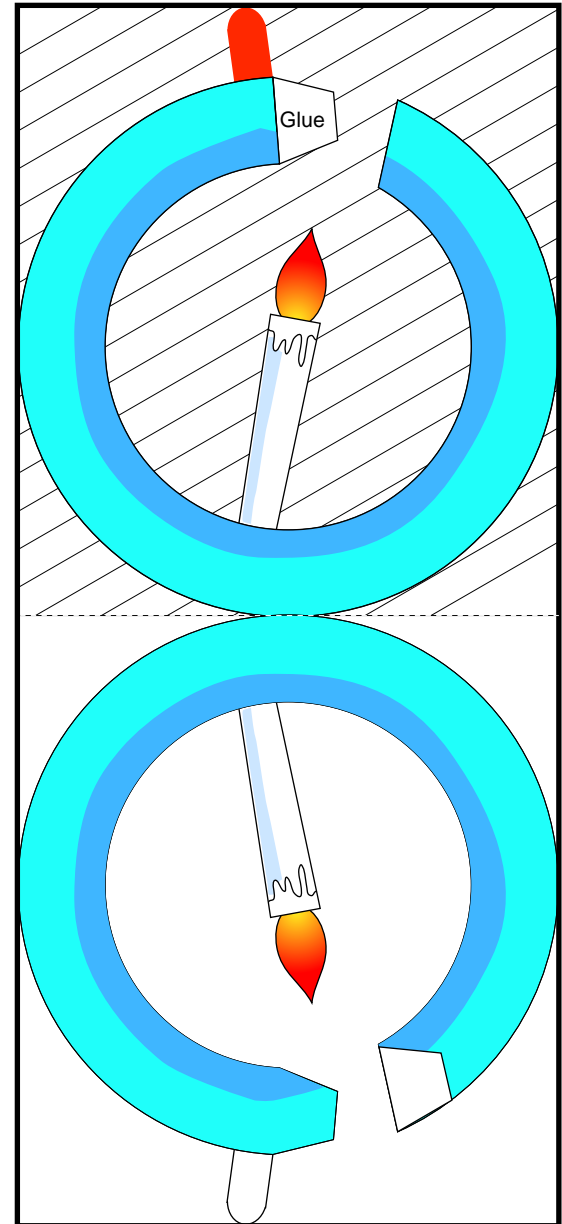
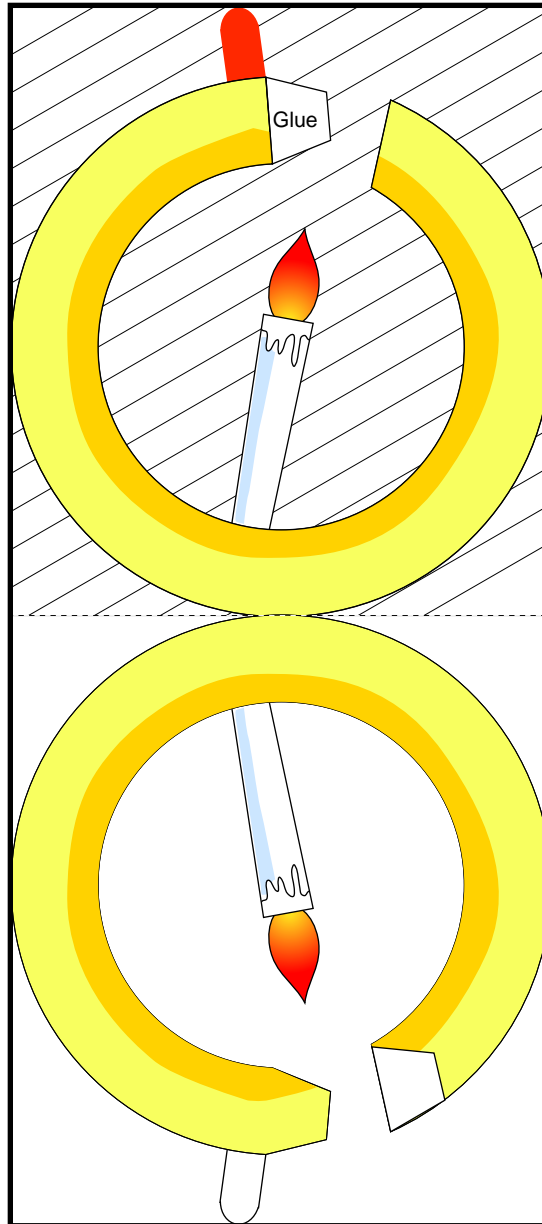
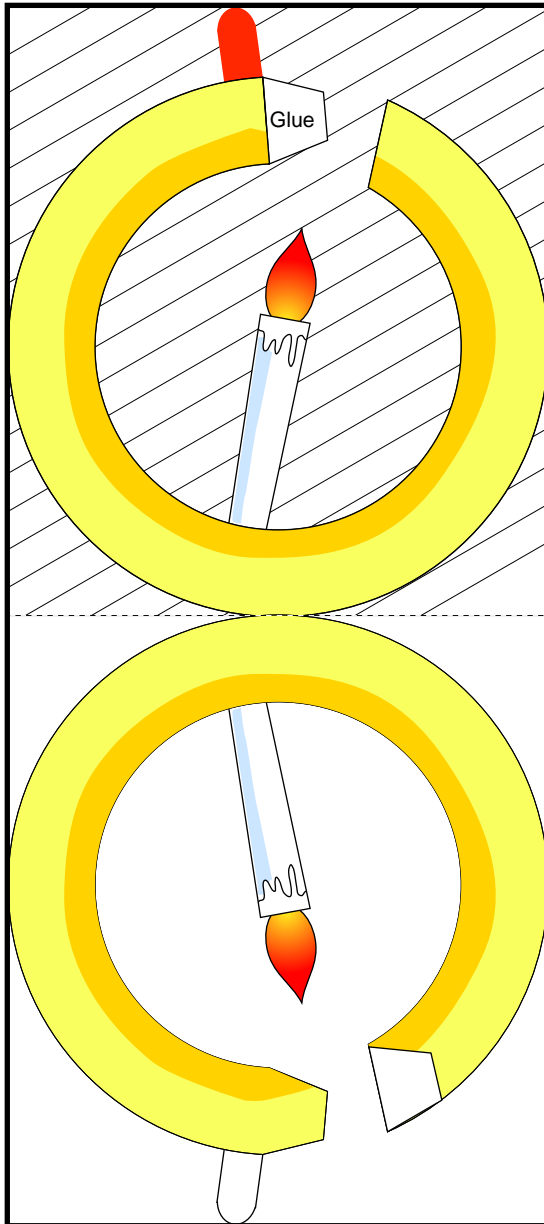



FOLIAGE SUPPORT

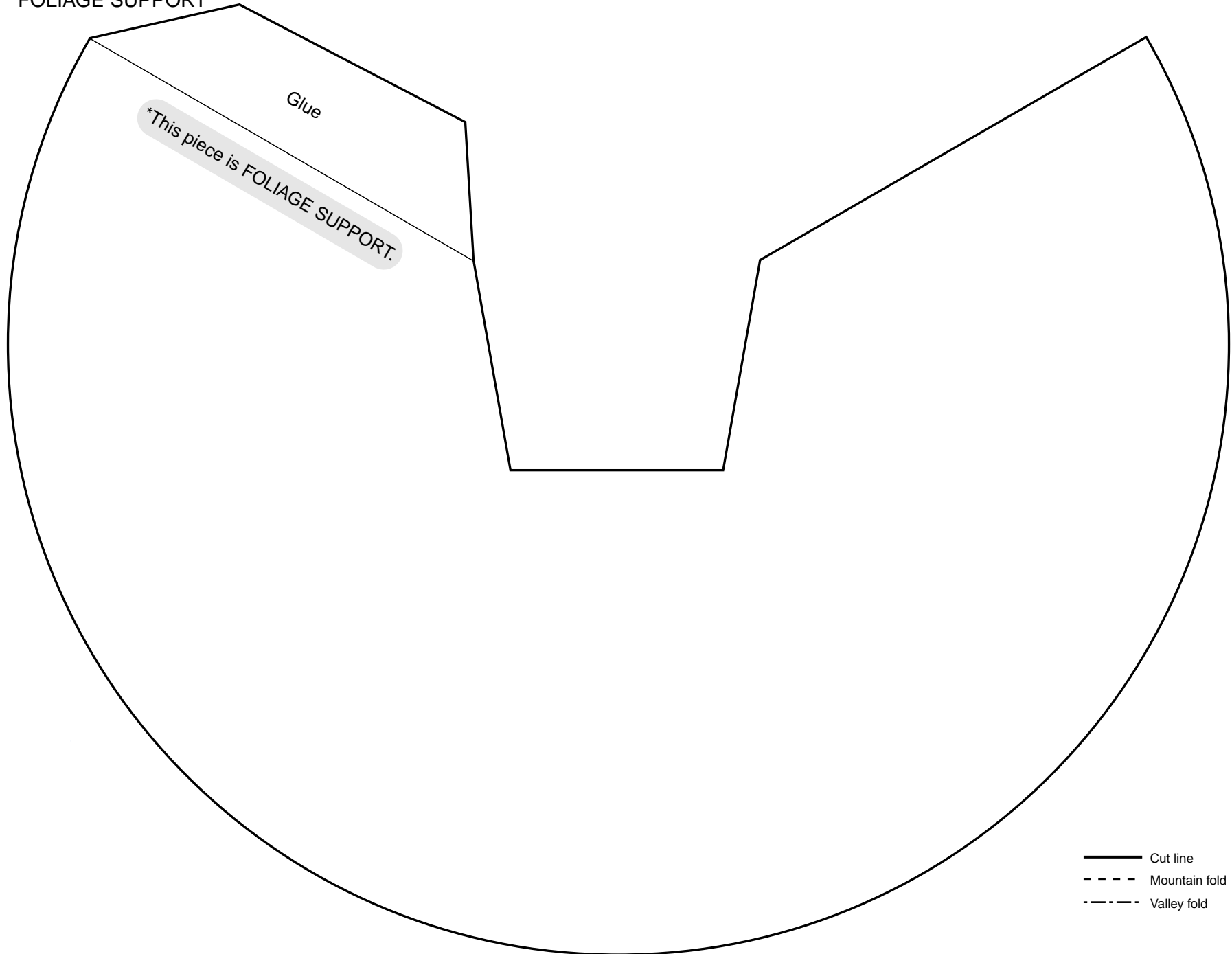

Glue

\*This piece is FOLIAGE SUPPORT.

- Cut line
- - - Mountain fold
- · - · - Valley fold