

Canon World Papercraft Mini-book

Buildings of the World Series India Taj Mahal

The Taj Mahal was built by Shah Jahan, ruler of the Mughal Empire, as a mausoleum for his deceased wife. Construction took 20 years. This Islamic monument exhibits perfect symmetry. Today it is considered as one of the most beautiful buildings in the world.



*Cut out the card above and save it. You can collect the cards from each of the Papercraft projects to make your own mini-book!

★ Directions

Print out pages 1 through 4, cut out each individual part along their cut lines, and fold along the mountain and valley fold lines.

1. Build dome 1

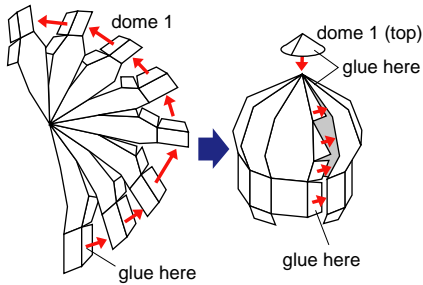

2. Build domes 2 - 5 and the minaret caps

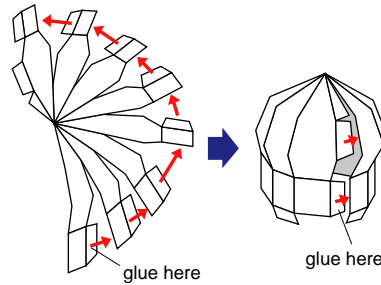

3. Build the minarets

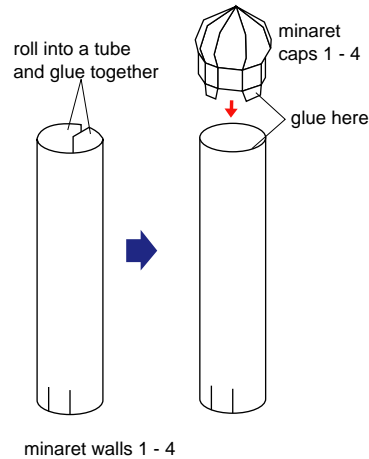

4. Build the main building

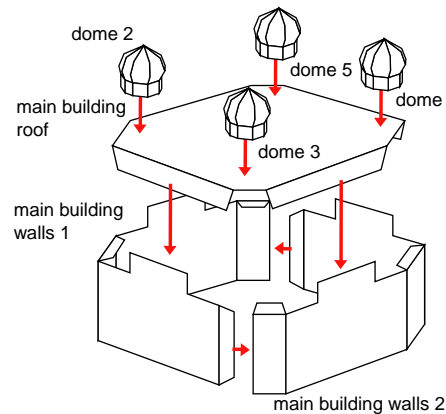

5. Build the base

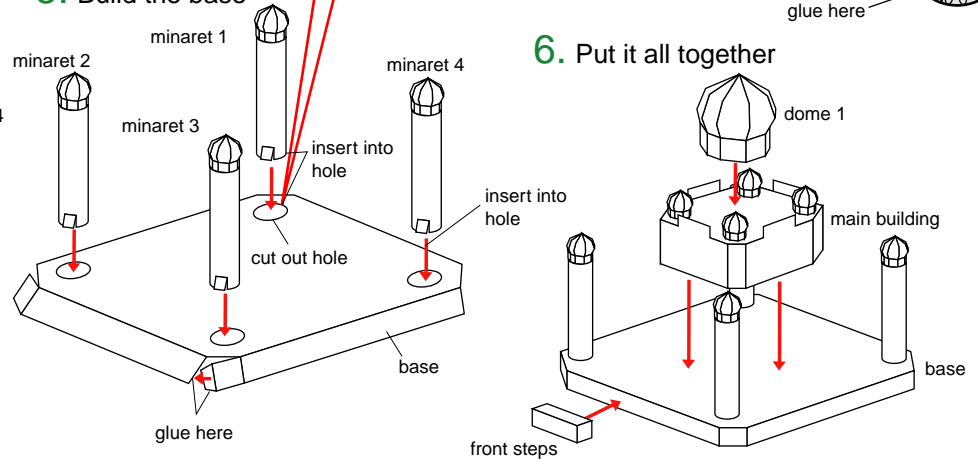

6. Put it all together

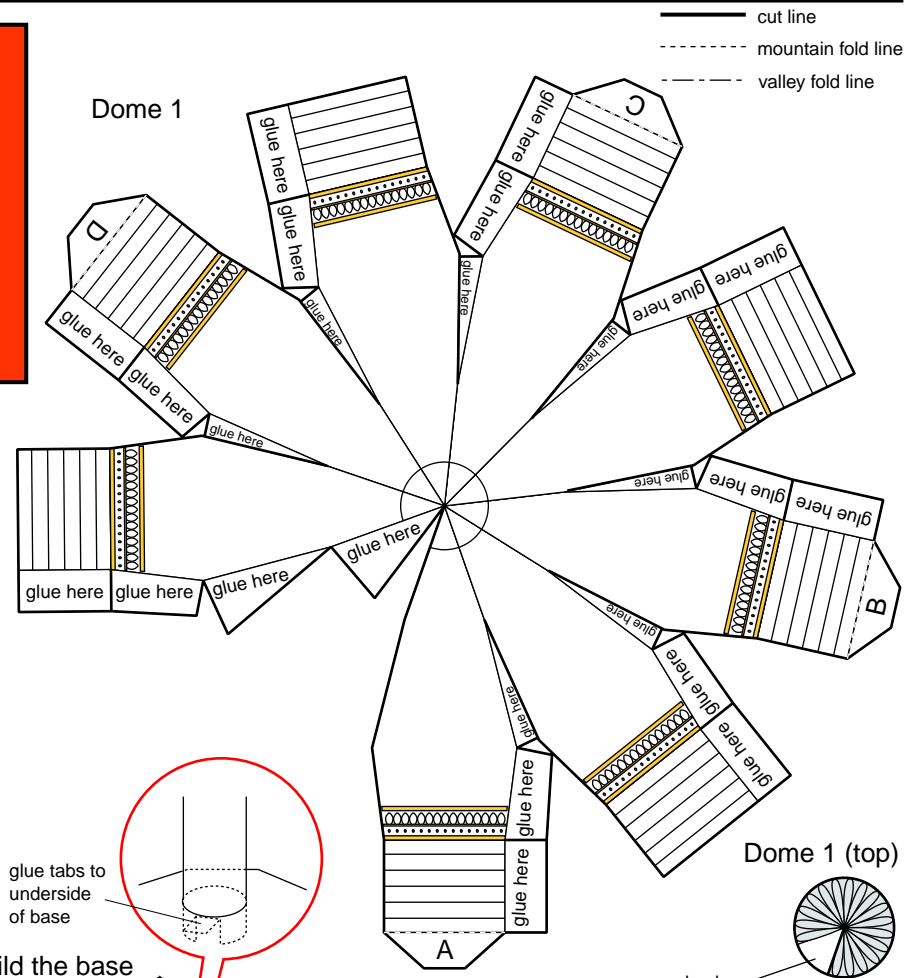
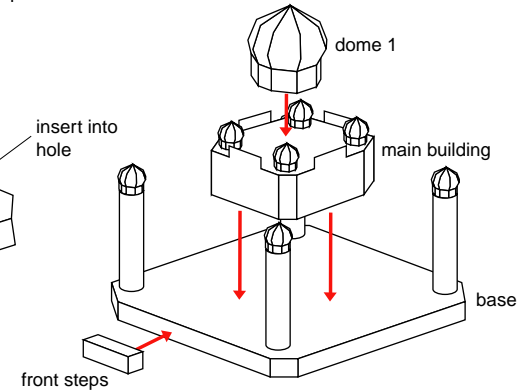

Main building walls 1

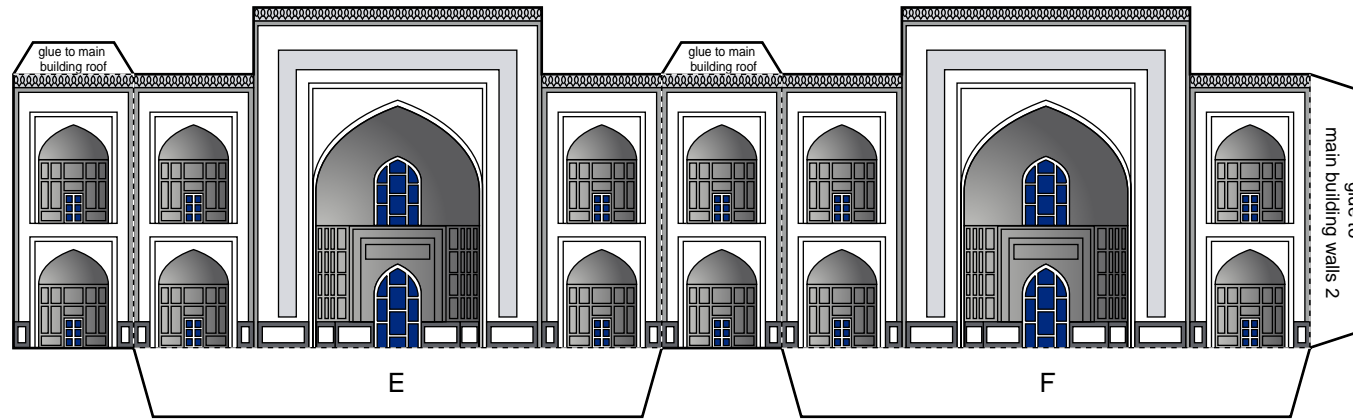

- cut line
- - - mountain fold line
- - - valley fold line

Front steps

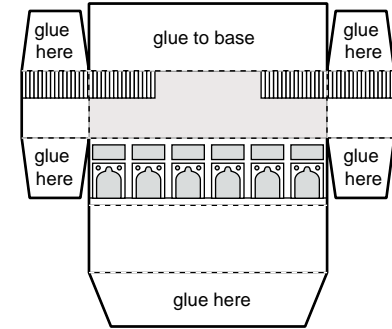

Main building walls 2

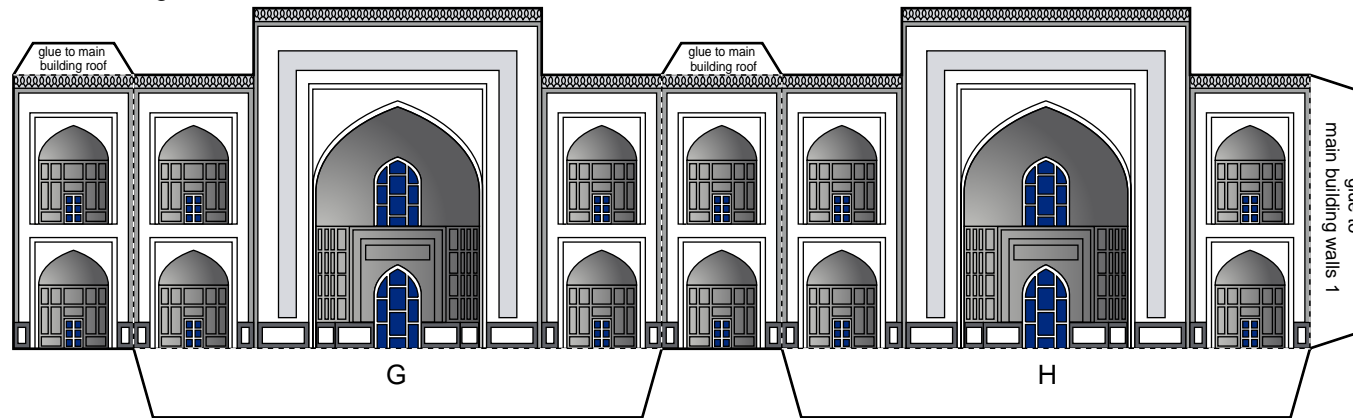

Dome 2

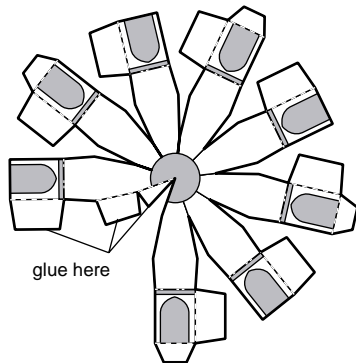

Dome 3

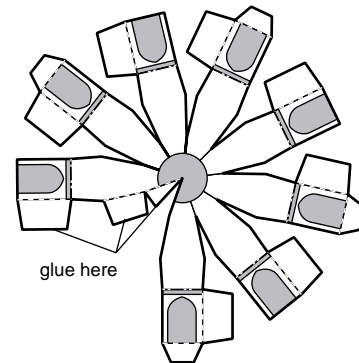

Dome 4

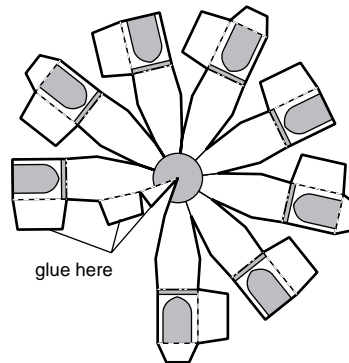

Dome 5

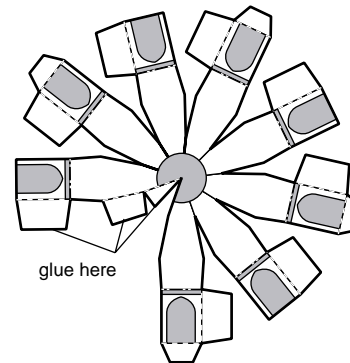

Base

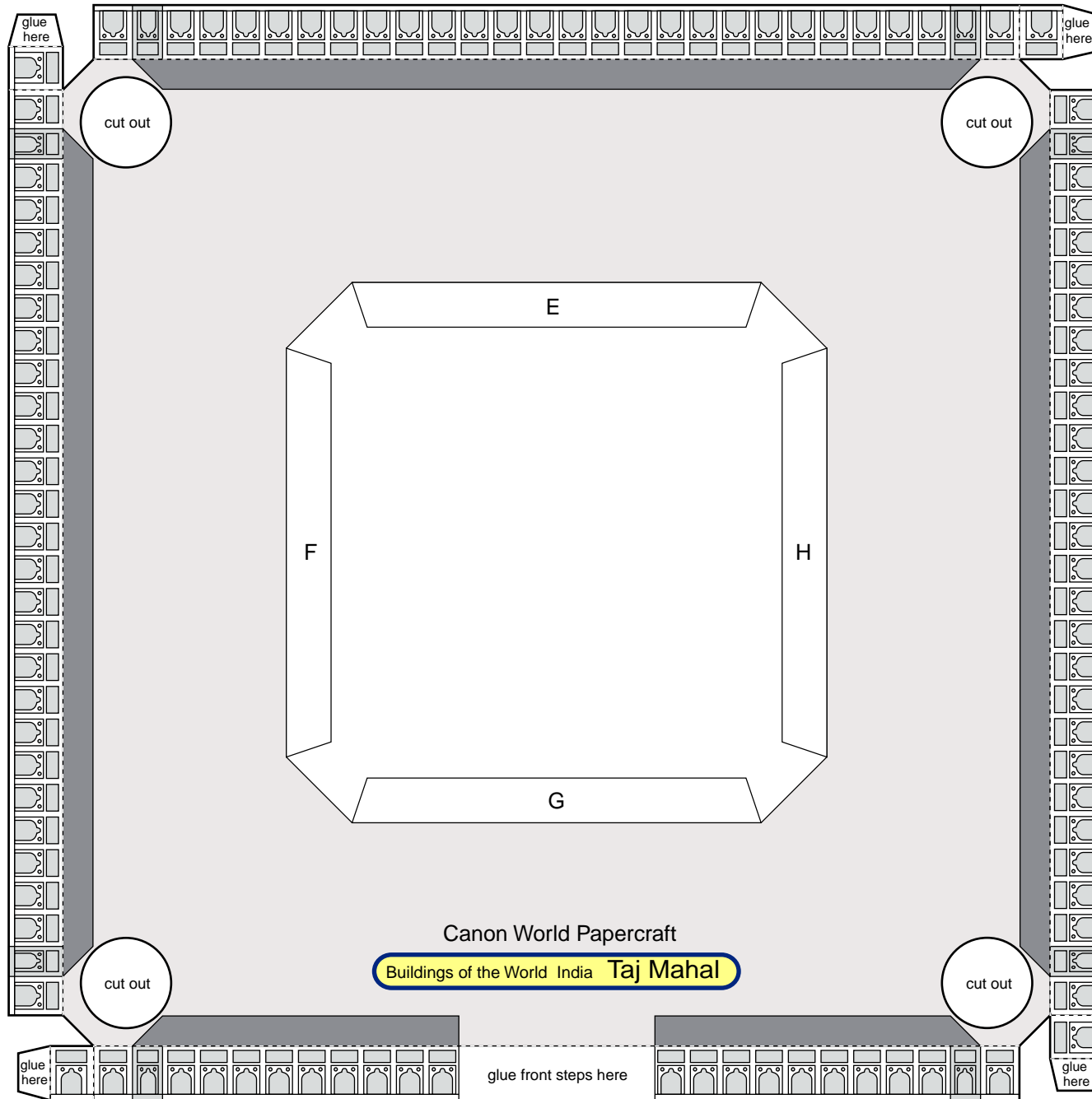

- cut line
- - - mountain fold line
- - - valley fold line

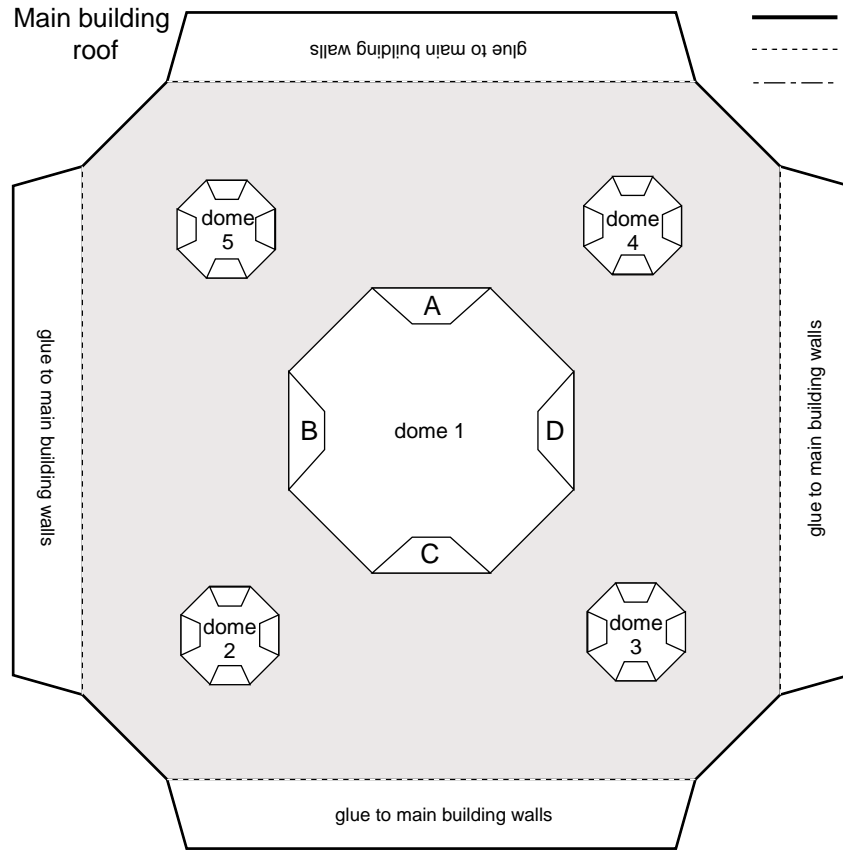

— cut line
 - - - mountain fold line
 - - - valley fold line

Minaret cap 1

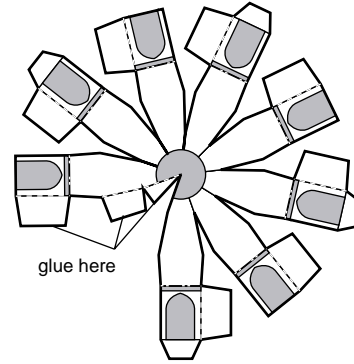

Minaret cap 2

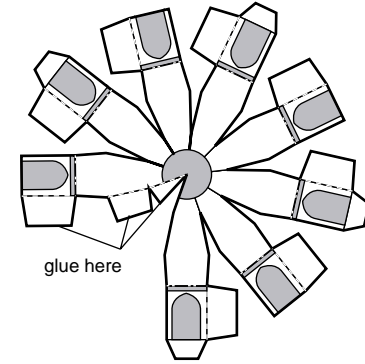

Minaret cap 3

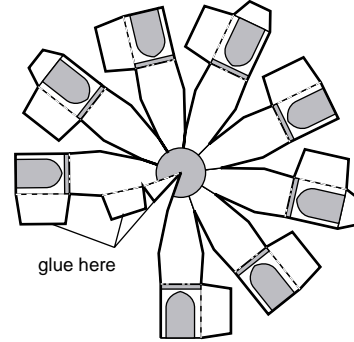

Minaret cap 4

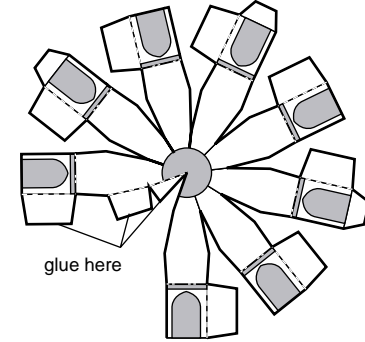

Minaret walls 1

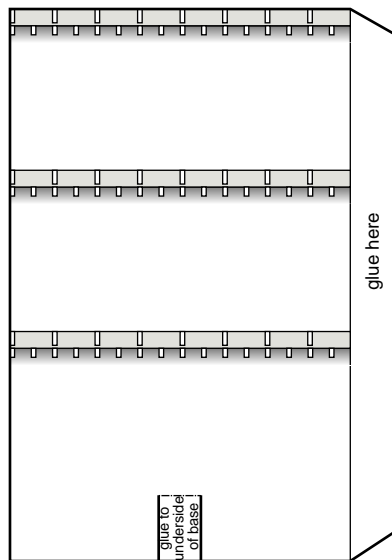

Minaret walls 2

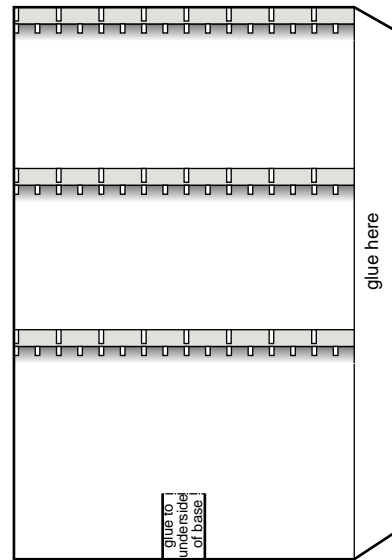

Minaret walls 3

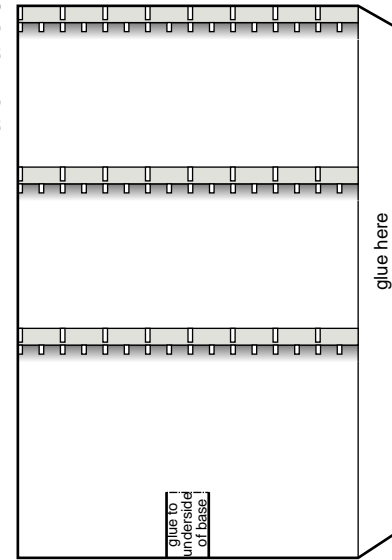

Minaret walls 4

