

Canon World Papercraft Mini-book

Buildings of the World Series Australia Sydney Opera House

Are they sails? Or beautiful sea shells?
 The Opera House, the most famous landmark of Sydney, Australia, was completed in 1973 after 14 years of construction.
 Along with the opera theater, these buildings also house a concert hall, large and small theaters, an exhibition area, a library, and more.



★ Directions

Print out pages 1 through 6, cut out each individual part along their cut lines, and fold along the mountain and valley fold lines.

1. Build the base

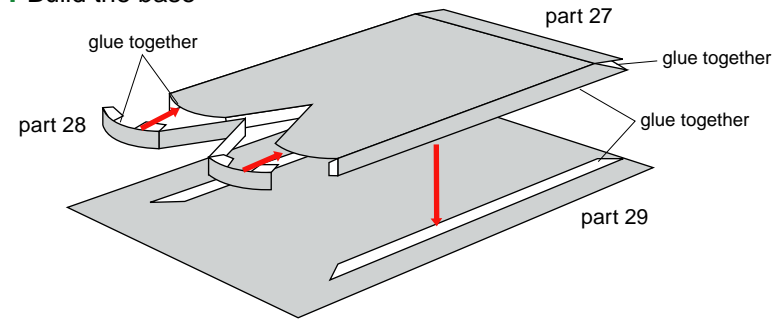

*Cut out the card above and save it. You can collect the cards from each of the Papercraft projects to make your own mini-book!

2. Build the concert hall and opera theater

* The opera theater is the same shape as the concert hall, but slightly smaller.
 The numbers in parentheses () indicate the part numbers for the opera theater.
 Build it in the same manner as the concert hall.

* glue the parts together in the order of increasing part number

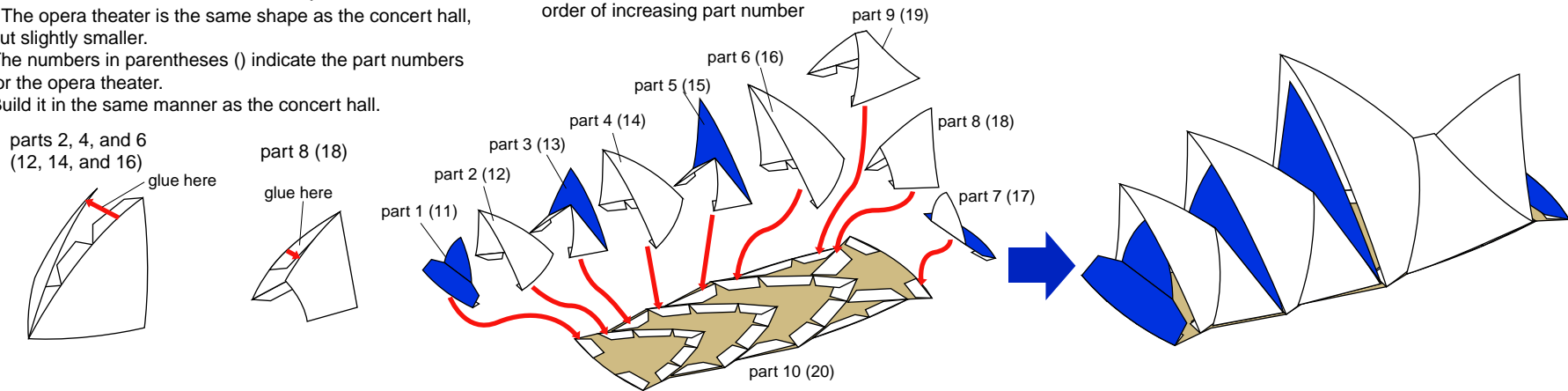

3. Build the restaurant

* glue the parts together in the order of increasing part number

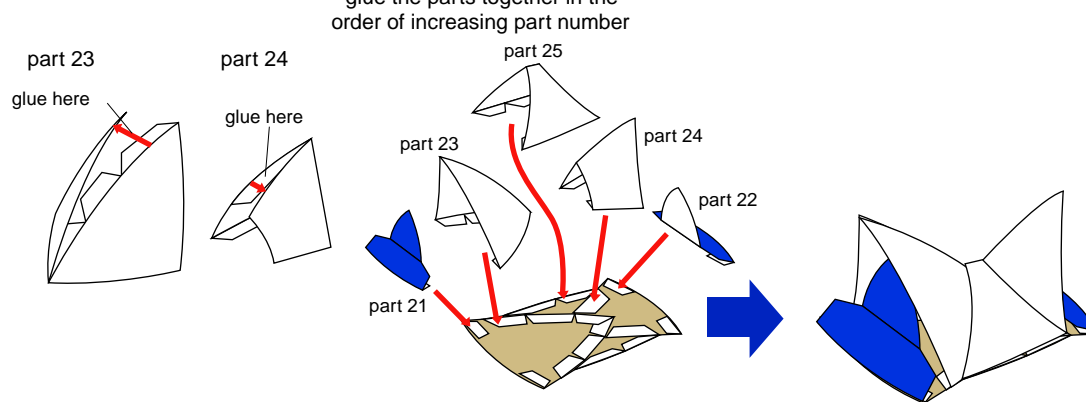

4. Place all the parts on the base

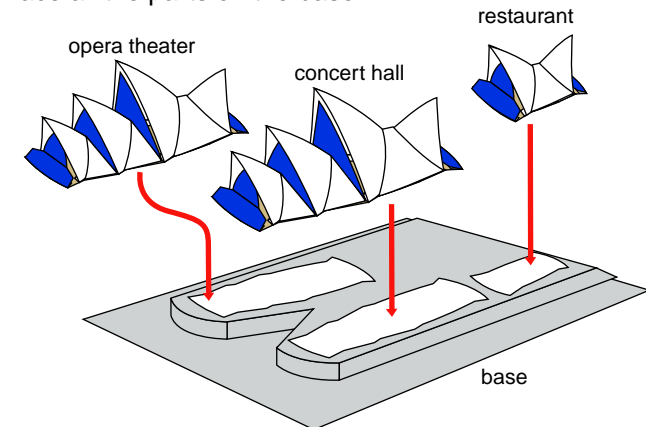

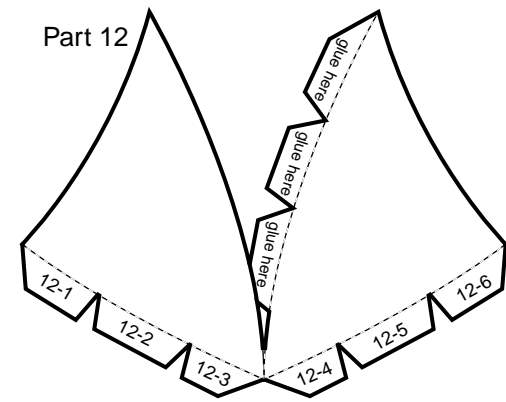
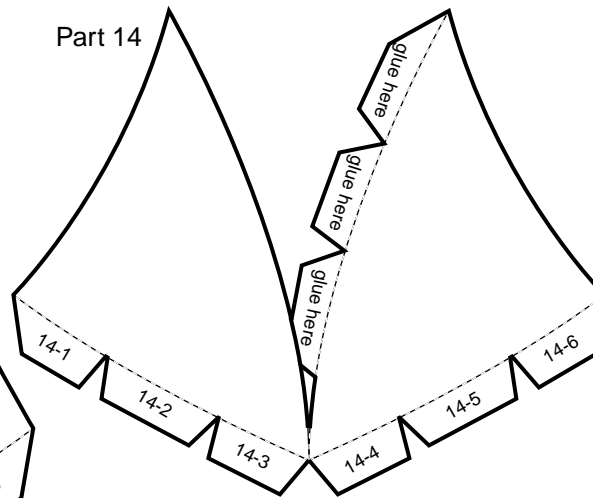
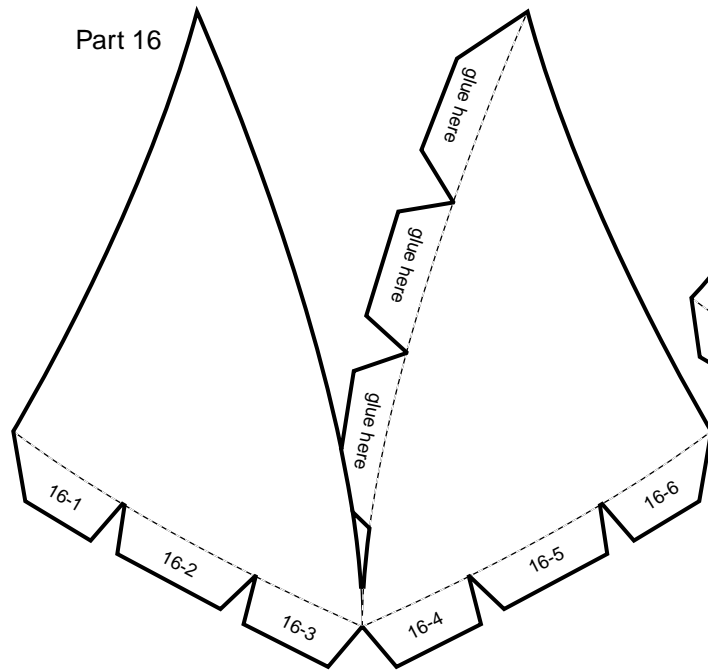

— cut line
- - - mountain fold line
- - - valley fold line

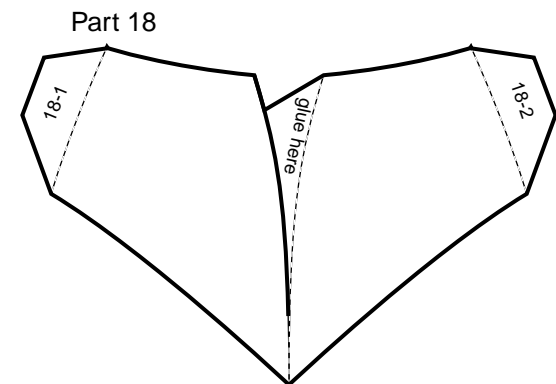
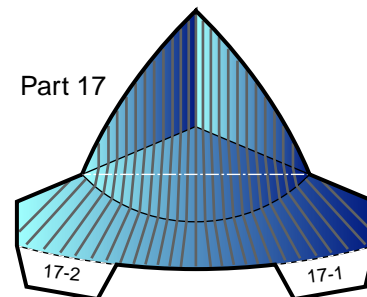
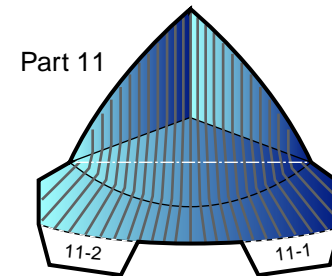
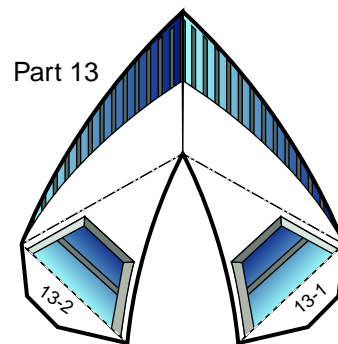
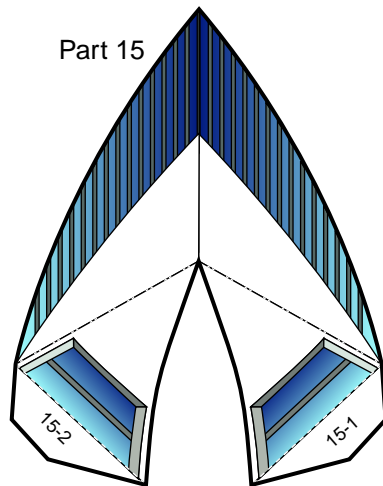
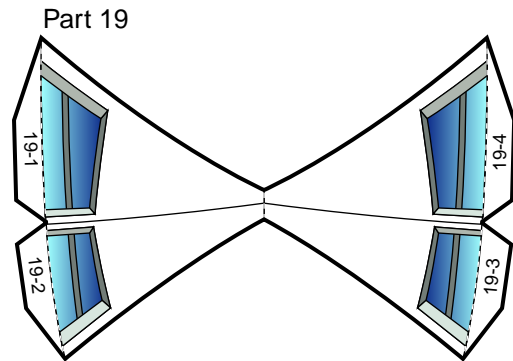

Part 10

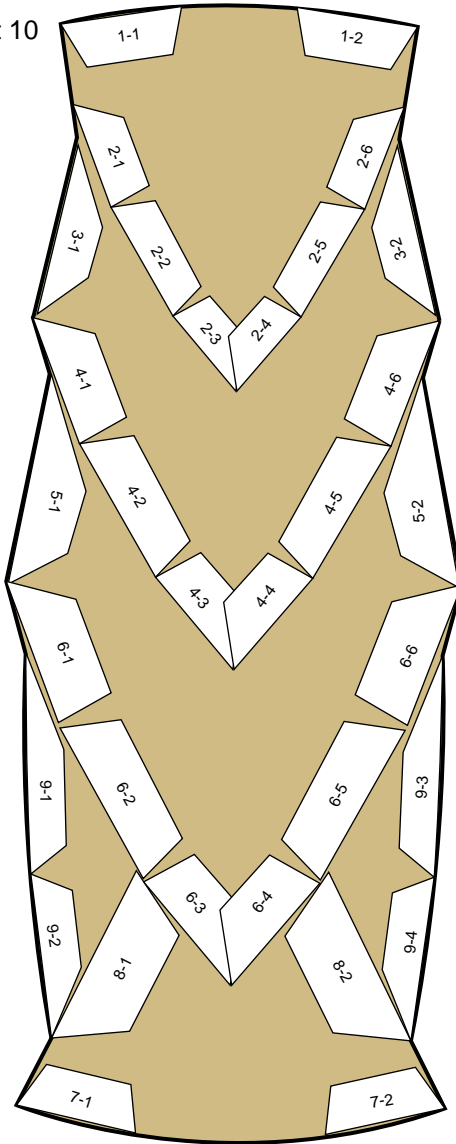

Part 20

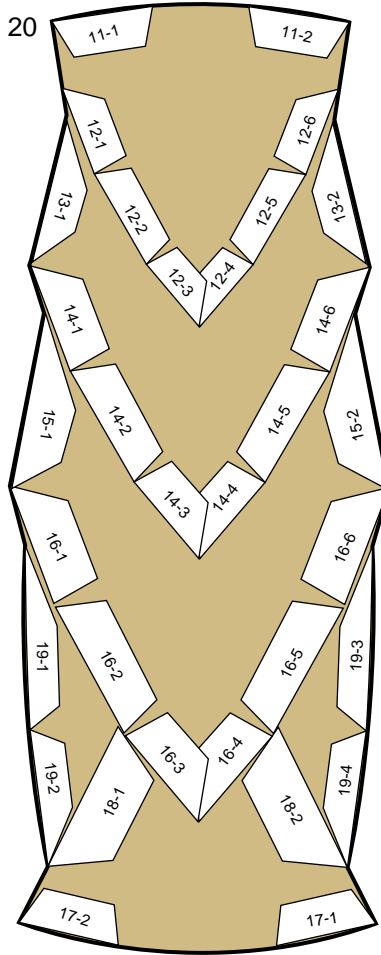

Part 23

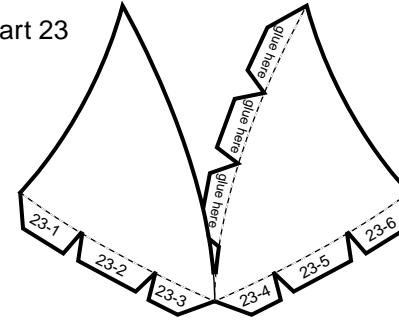

Part 24

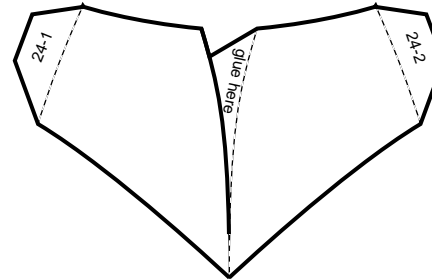

Part 25

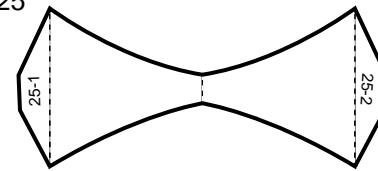

Part 26

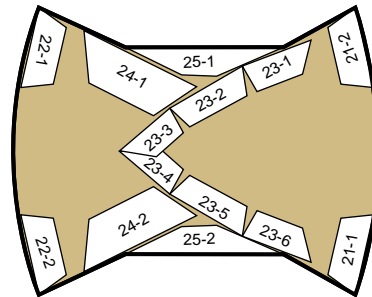

Part 21

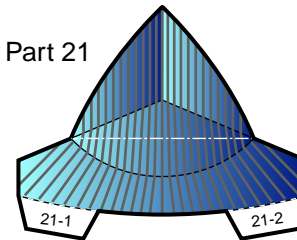

Part 22

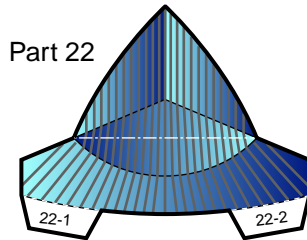

- cut line
- - - mountain fold line
- - - valley fold line

Part 27

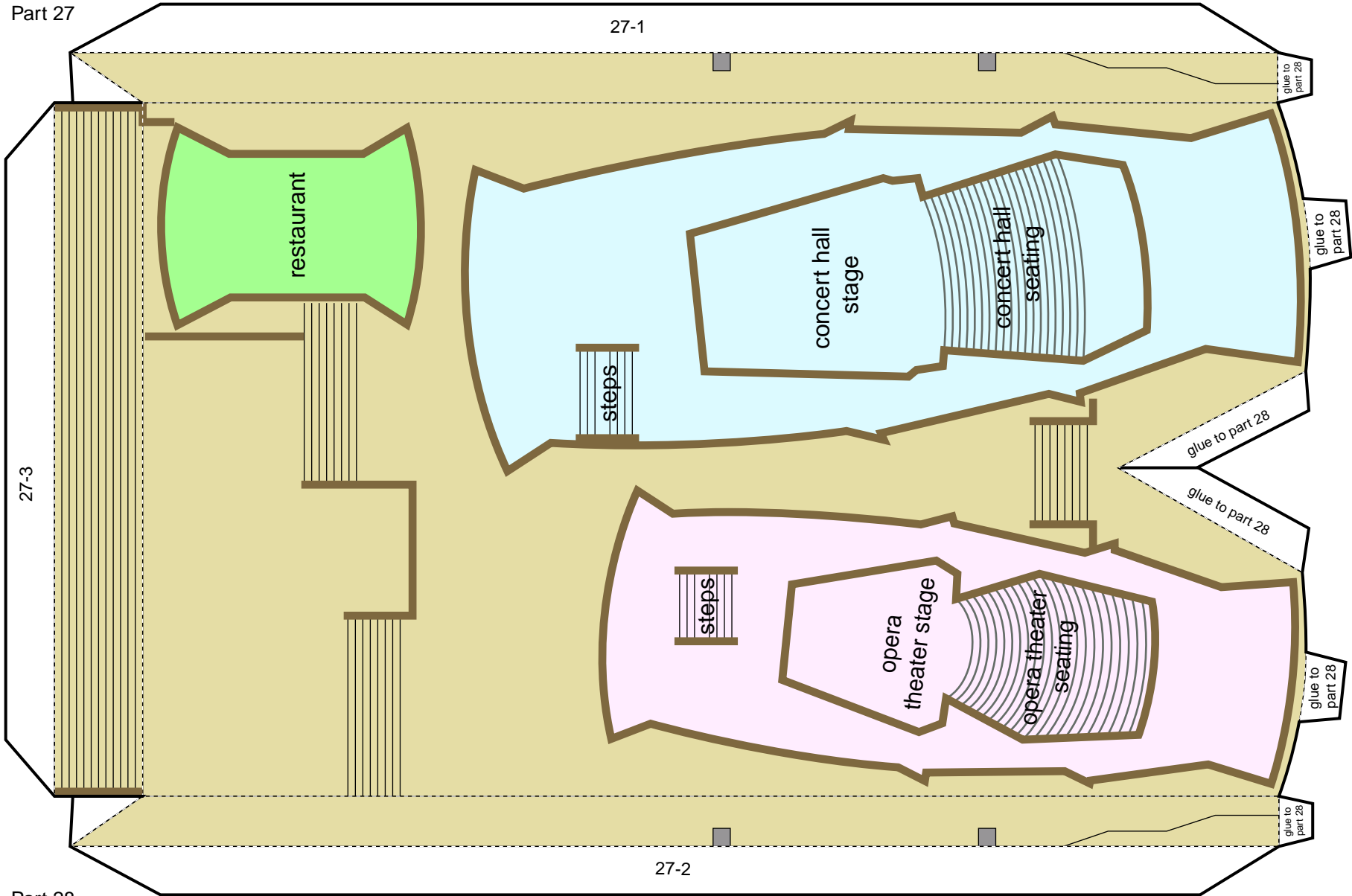

Part 28

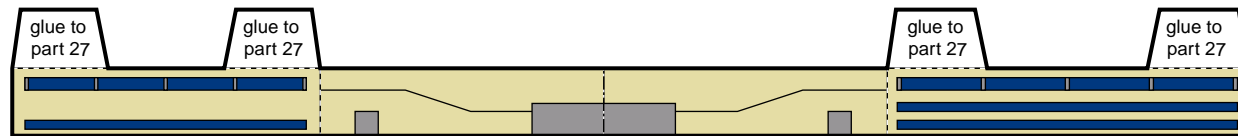

- cut line
- - - mountain fold line
- · - valley fold line

Part 29

