

Canon World Papercraft Mini-book

Buildings of the World Series

Egypt The Lighthouse of Alexandria

This great lighthouse, which is counted as one of the seven wonders of the world, was constructed on a reef called the island of Pharos (at Alexandria, in present-day Egypt) about A.D. 250 by Ptolemy Philadelphus. It is said that its light, generated by a fire and projected by a mirror, could be seen up to 50 kilometers (30 miles) away. The lighthouse was destroyed in the 14th century. A medieval fortress was built on the site, obliterating any trace of its remains.



*Cut out the card above and save it. You can collect the cards from each of the Papercraft projects to make your own mini-book!

★ Directions

Print out pages 1 through 3, cut out each individual part along their cut lines, and fold along the mountain and valley fold lines.

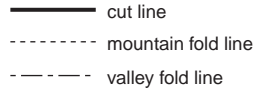

1. Build the pedestal

* align the tabs and glue together

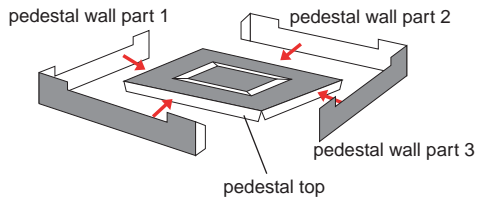

2. Build the lower tower

* align the tabs and glue together

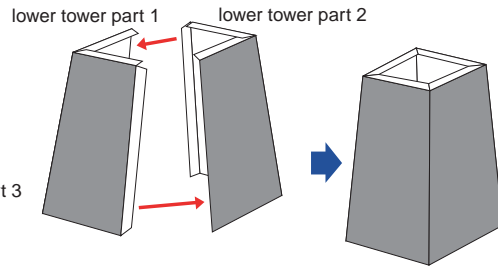

3. Build the lower tower roof

* align the tabs and glue together

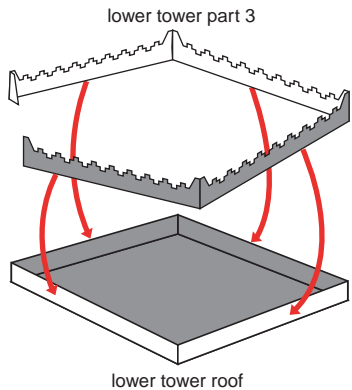

4. Build the central tower

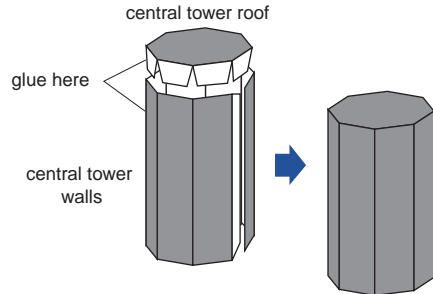

5. Upper tower

* build the hexagonal tower

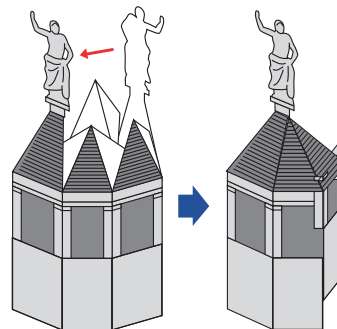

6. Put it all together

* glue together in order shown by numbers in the figure

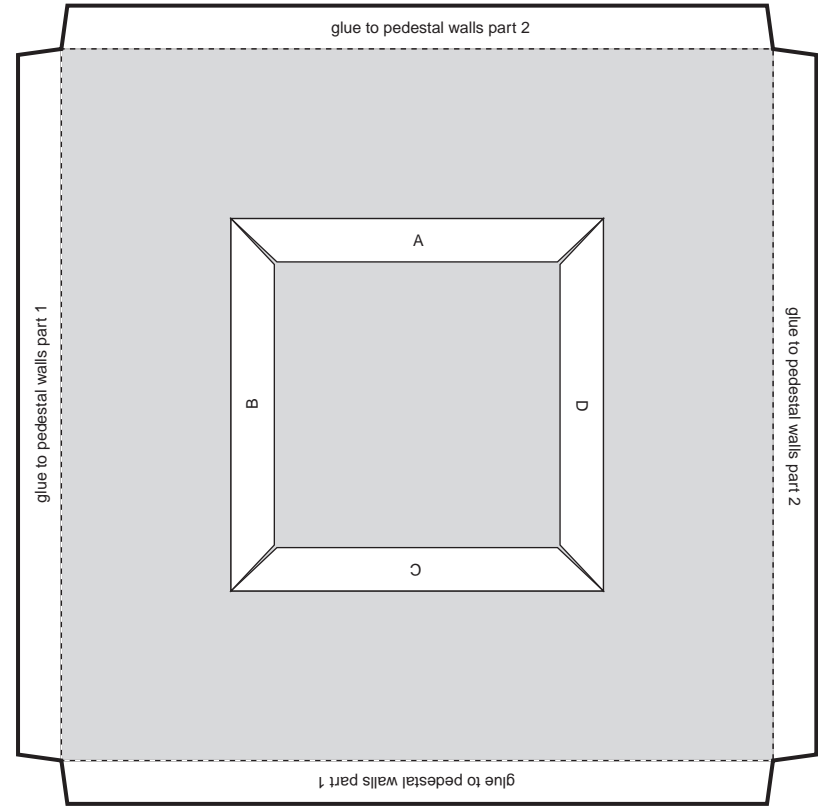
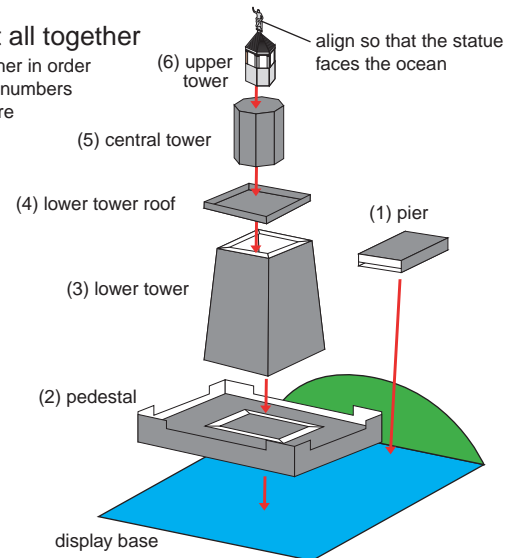

Lower tower roof

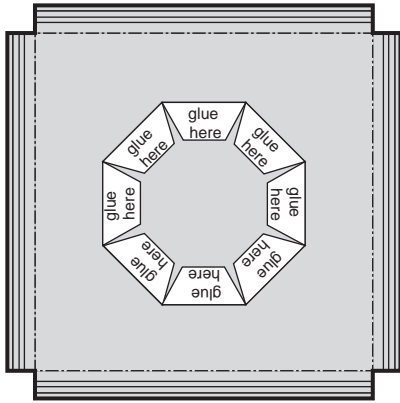

Central tower walls

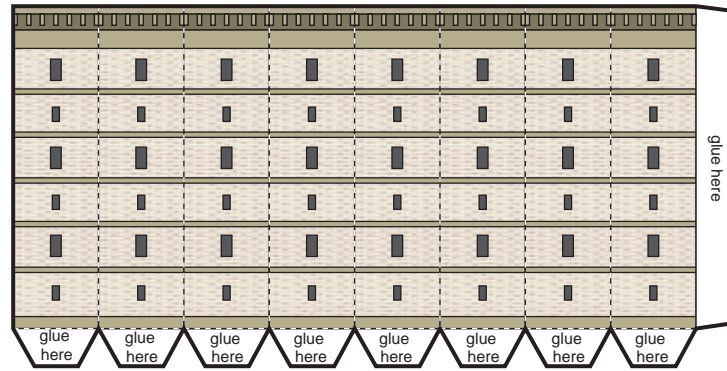

Upper tower

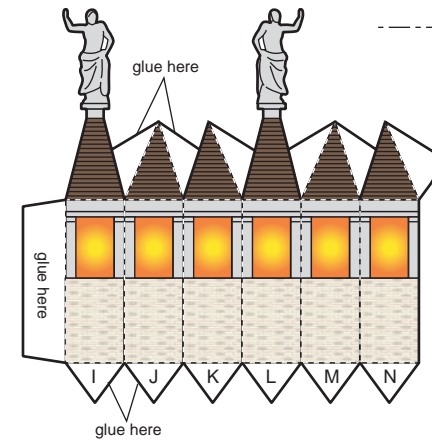

Lower tower part 1



Lower tower part 2

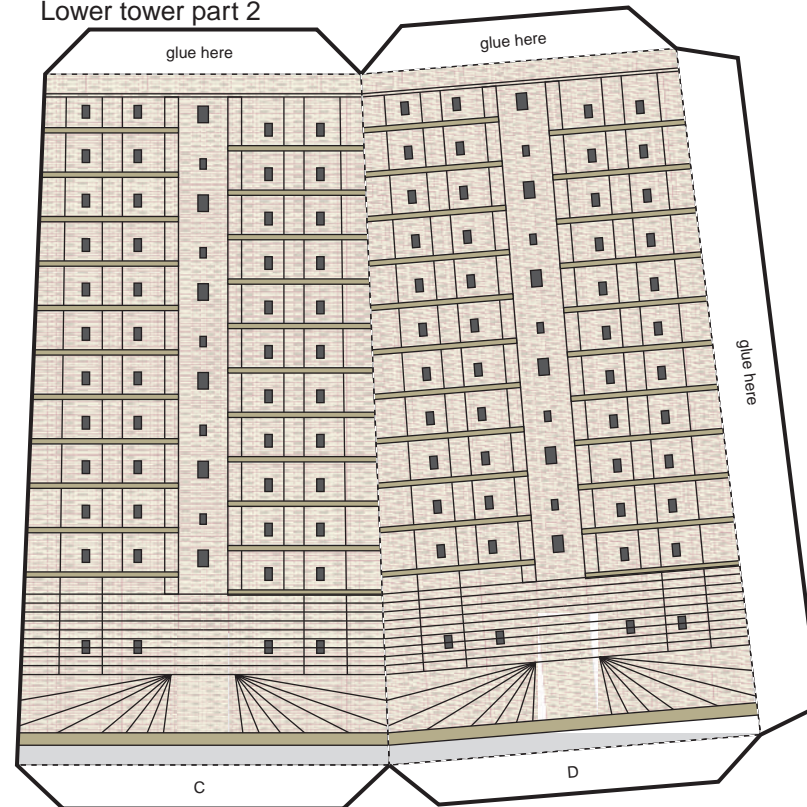

Lower tower part 3



Pedestal wall part 1

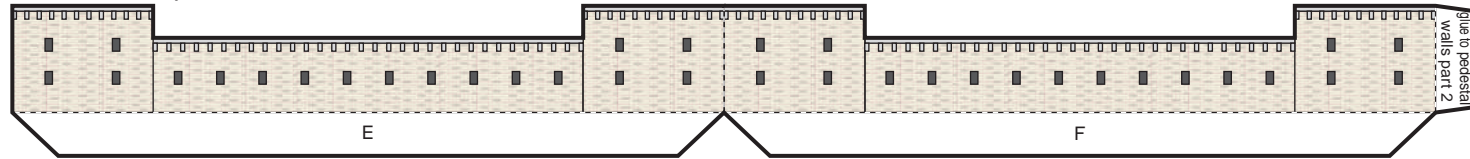

Pedestal wall part 2

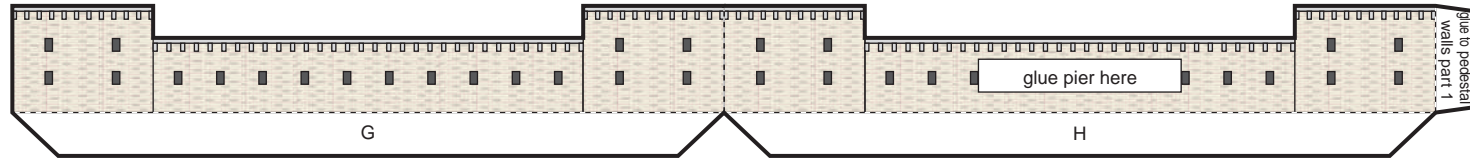

Central tower roof

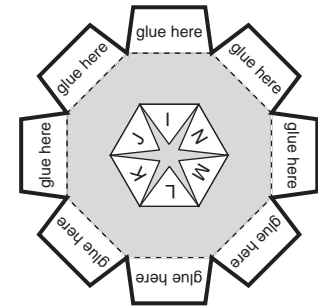

Pier

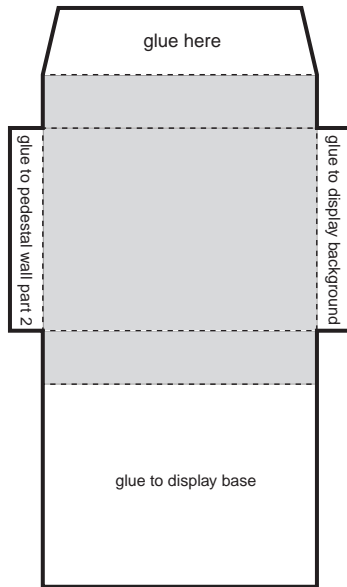

Display base

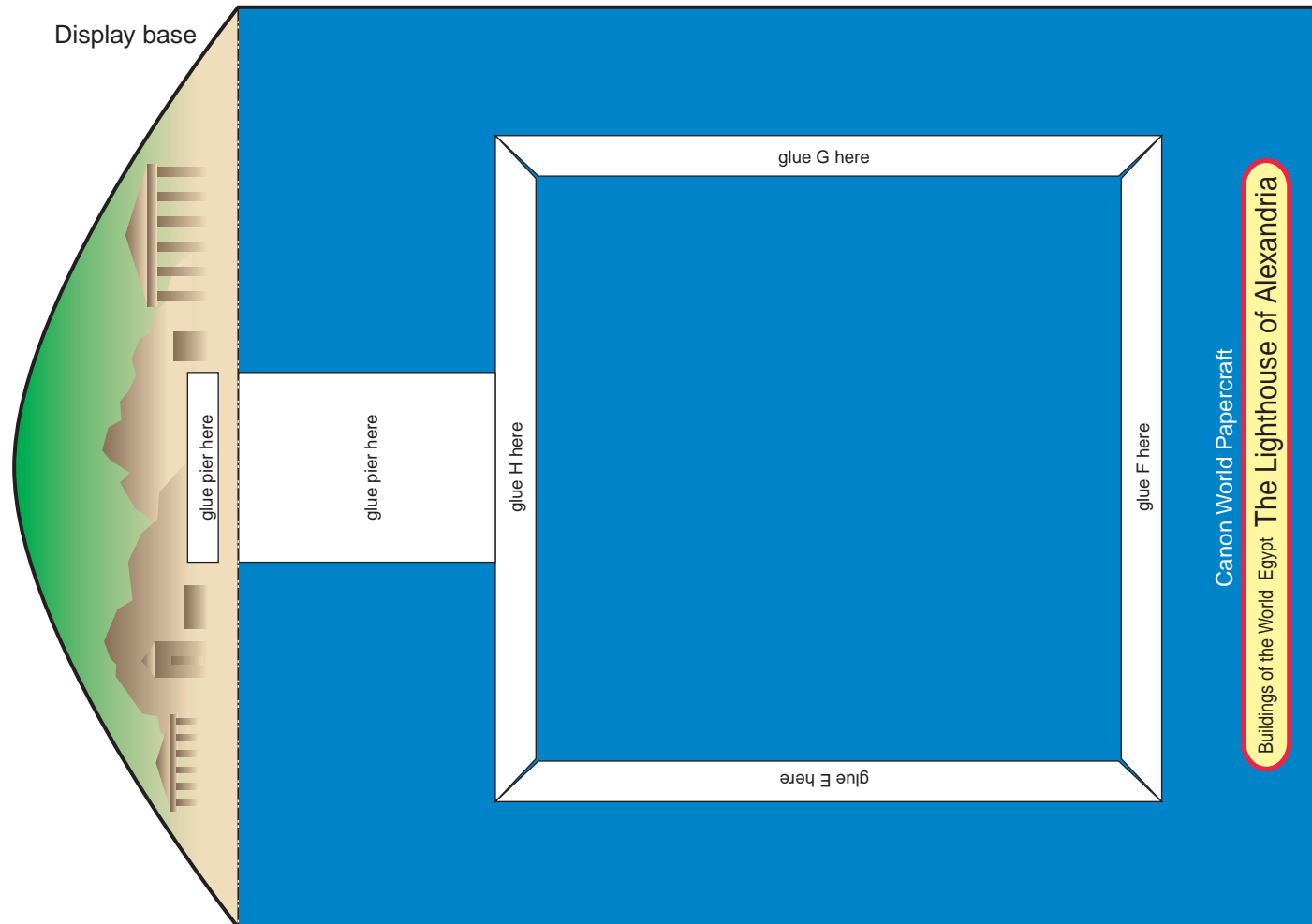

Canon World Papercraft
Buildings of the World Egypt The Lighthouse of Alexandria

- cut line
- - - mountain fold line
- - - valley fold line