

Canon Gift box A (Pink) : Assembly Instructions

Canon ® is a registered trademark of Canon Inc. © Canon Inc. © Yukiko Tanikoshi



You will need

scissors, paste, a used ballpoint pen (tracing along the fold lines makes them easier to fold)

Explanation of Symbols

▲ Numbered glue tabs

Glue the parts together in the order indicated by the numbers.



[Caution]

Glue, scissors and other tools may be dangerous to young children so be sure to keep them out of the reach of young children.

Assembly procedure

— Cut line

- - - Mountain fold

- · - · - Valley fold

STEP

1 Preparation

Fold and crease along the mountain fold line.

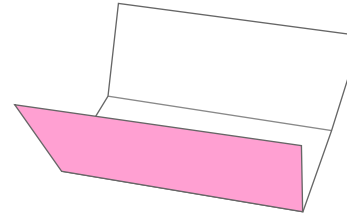

Part 1



Part 3

STEP

2 Make the base of the box



Paste here.

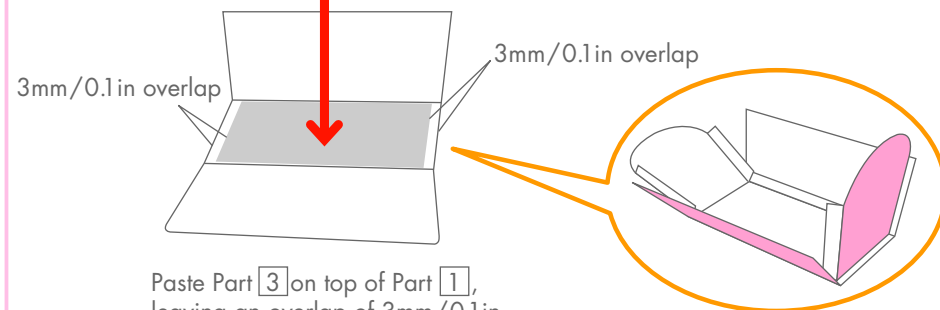

Paste Part 3 on top of Part 1, leaving an overlap of 3mm/0.1 in at both ends of Part 1.

Canon Gift box A (Pink) : Assembly Instructions

Canon® is a registered trademark of Canon Inc. © Canon Inc. © Yukiko Tanikoshi

Assembly procedure

STEP

3 Make the sides of the box

Paste on the sides so that there is a 3mm/0.1in overlap on both sides, the same as with the base.

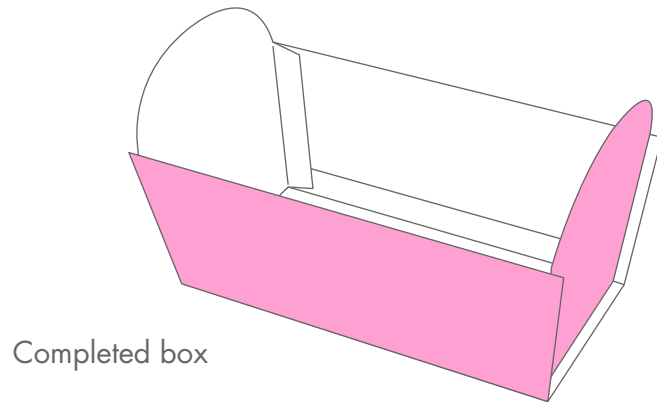
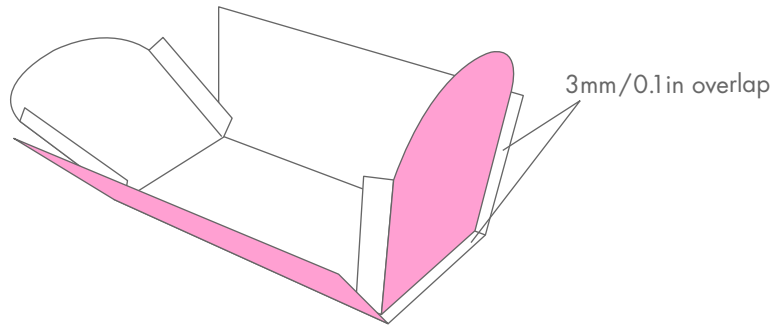

STEP

4 Make the lid of the box, starting from the back

Paste Part 5 onto the back side of the box.

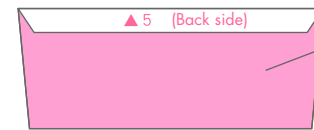
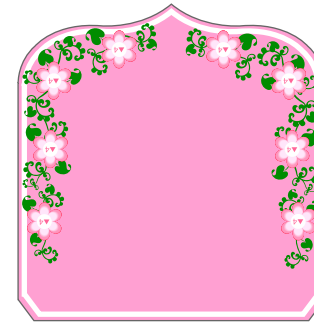

Back side of box

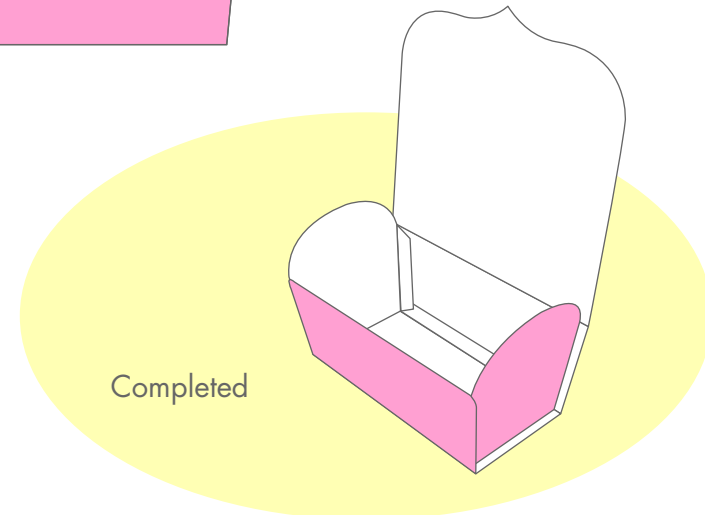

Canon Gift box A (Pink) : Assembly Instructions

Canon ® is a registered trademark of Canon Inc. © Canon Inc. © Yukiko Tanikoshi

Assembly procedure

STEP

5 Assemble flowers (eight)

Curve the petals of Part 2 and Part 4 upwards with your fingers.

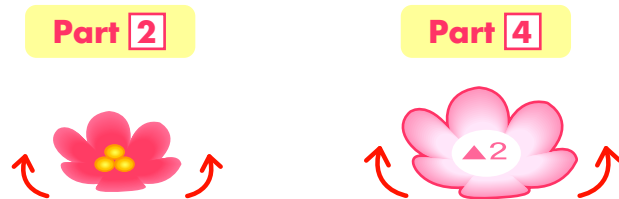

Paste Part 2 onto Part 4. (Assemble eight small flowers in the same way.)

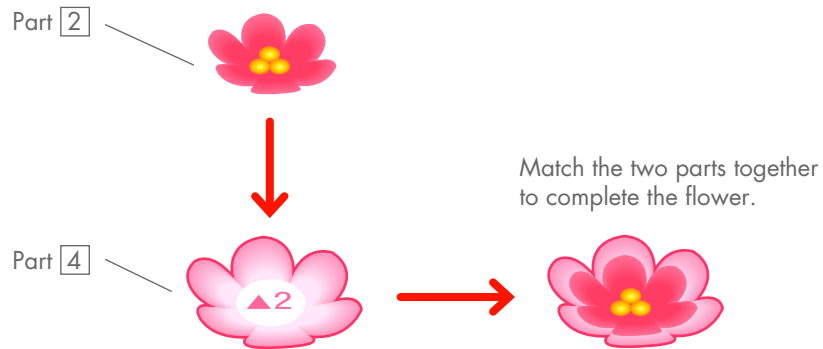

STEP

6 Attach the flowers to the lid

Paste the flowers made in Step 5 onto the locations indicated (total: eight).

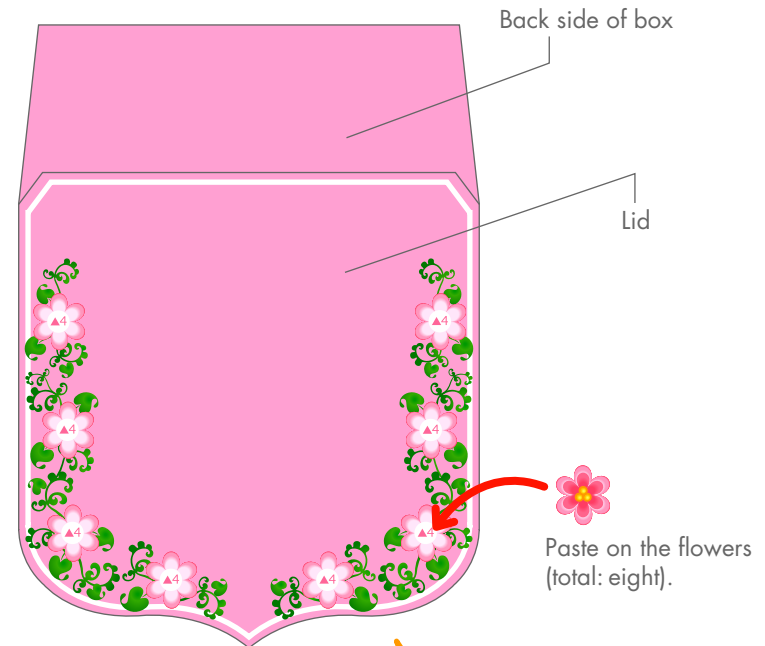

Canon Gift box A (Pink) : Assembly Instructions

Canon ® is a registered trademark of Canon Inc. © Canon Inc. © Yukiko Tanikoshi

Assembly procedure

STEP 7 Make a flower seal (one)

Curve the petals of Part [6] and Part [7] upwards with your fingers.

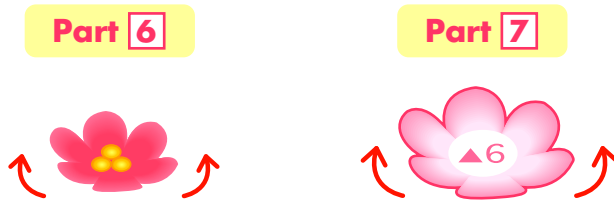

Paste Part [6] onto Part [7].

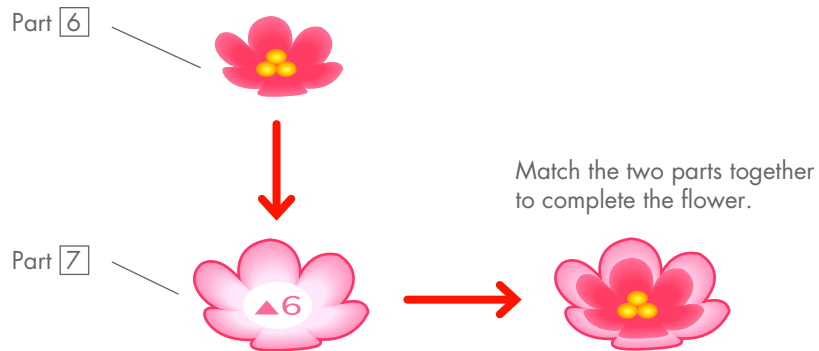

STEP 8 Put a present in the box and close the lid

Once the present is in the box, close the lid and seal it with the flower. (If the lid is difficult to close, apply a little glue to it first.)

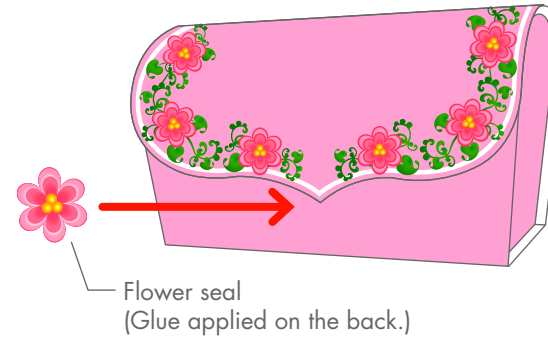

Once the lid is firmly closed with the flower seal, you're finished.

