

Canon 3D-Papercraft Mini-book

Toy series

**Backgammon**

Backgammon is a game where two players roll dice to move their checkers around a board, moving across a series of points. The first player to move all their checkers off the board wins the game. Backgammon is said to have originated with a game called Senat in ancient Egypt. It traveled by way of ancient Greece to Europe, where its rules were established in their modern form. Today, backgammon is one of the most popular board game in the world.



This game board is designed to fold up. To carry the board, fold it in half, and store the dice and checkers inside. Slip the folded board inside a VHS videocassette case for convenient storage.

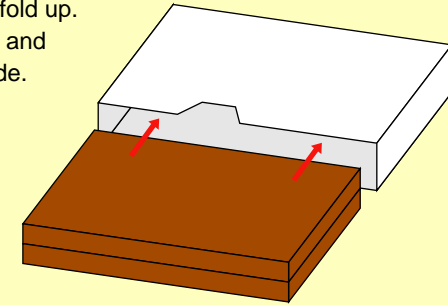

\* Cut out the card above and save it. You can collect the cards from each of the Papercraft projects to make your own mini-book!

## ★Directions

Print out these pages. Cut out all the parts, and fold along the mountain and valley fold lines.



### 1. Build GAME BOARD A and B

#### ● GAME BOARD A

#### ● GAME BOARD B

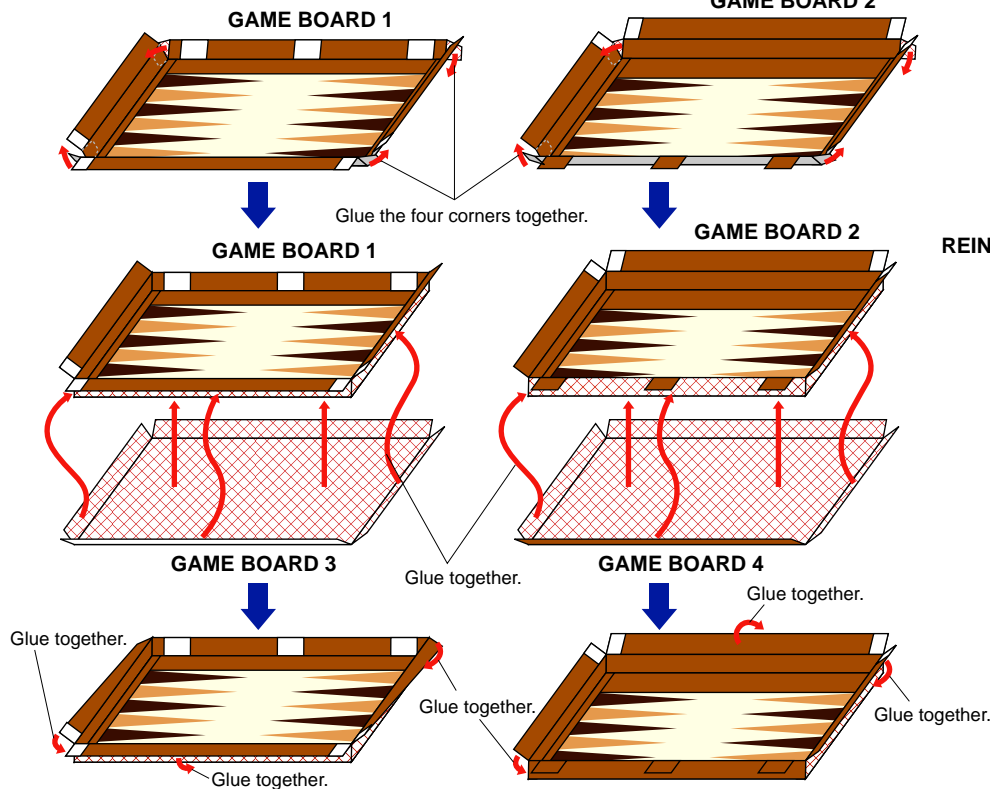

### 2. Assemble the GAME BOARD

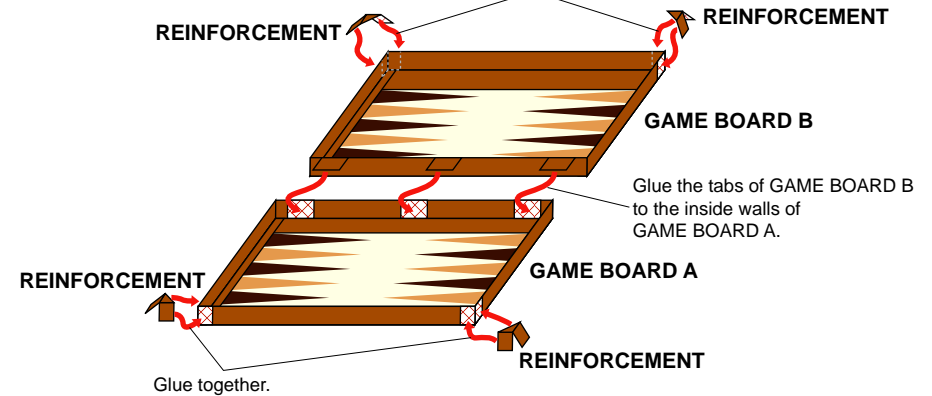

### 3. Build the CHECKERS

(15 white, 15 black)

\*Build the black CHECKERS in the same manner.

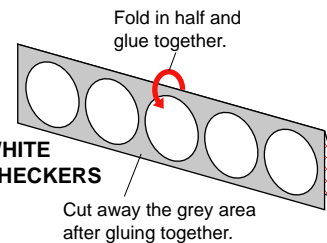

### 4. Build the DICE

\*Build both DICE in the same manner.

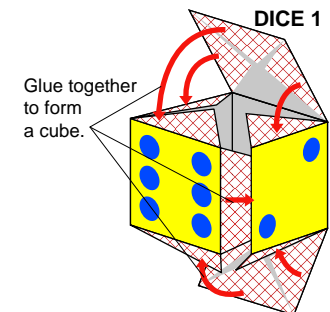

— Cut line  
 - - - Mountain fold line  
 - - - Valley fold line

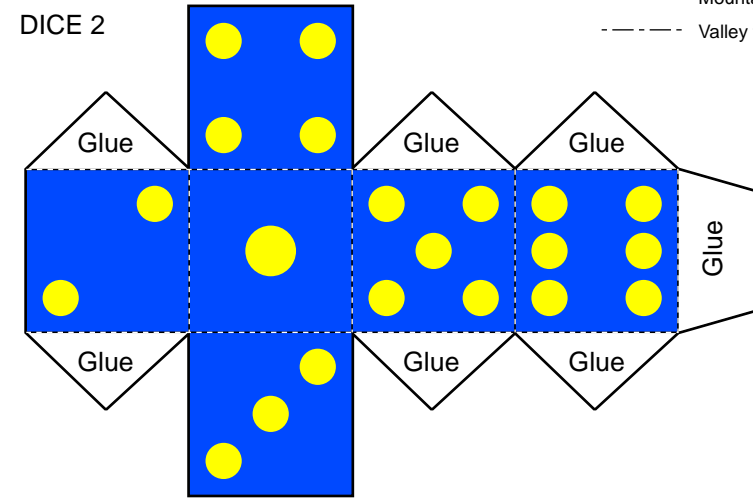
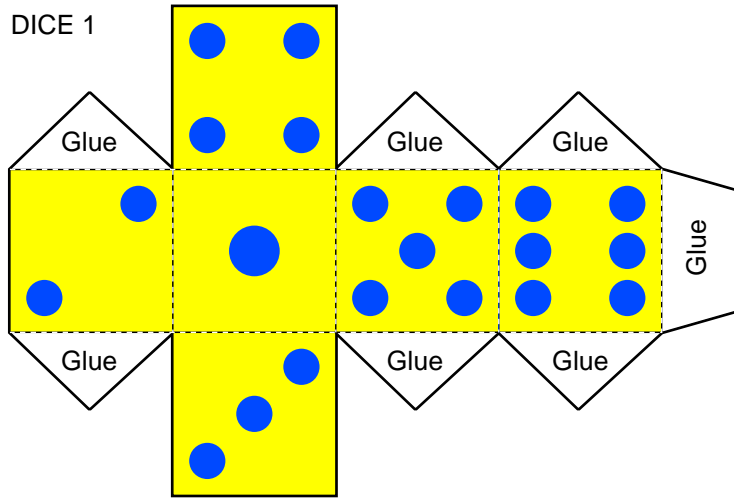

WHITE CHECKERS

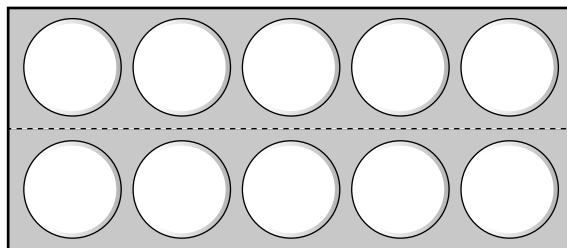
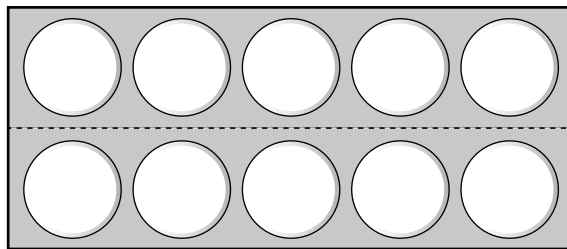
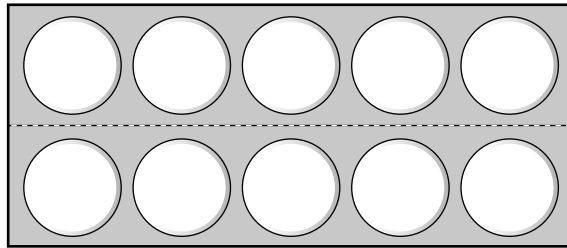

BLACK CHECKERS

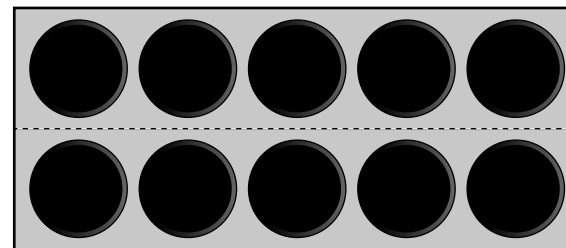
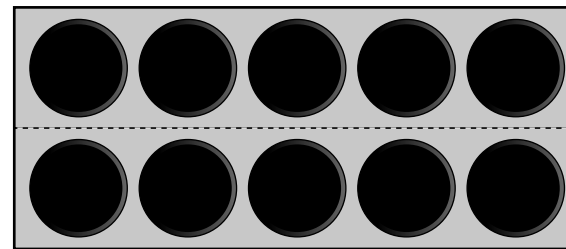
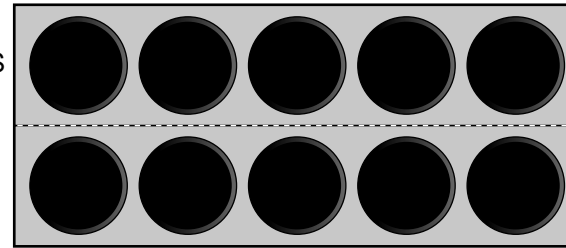

- Cut line
- - - Mountain fold line
- - - Valley fold line

GAME BOARD 1

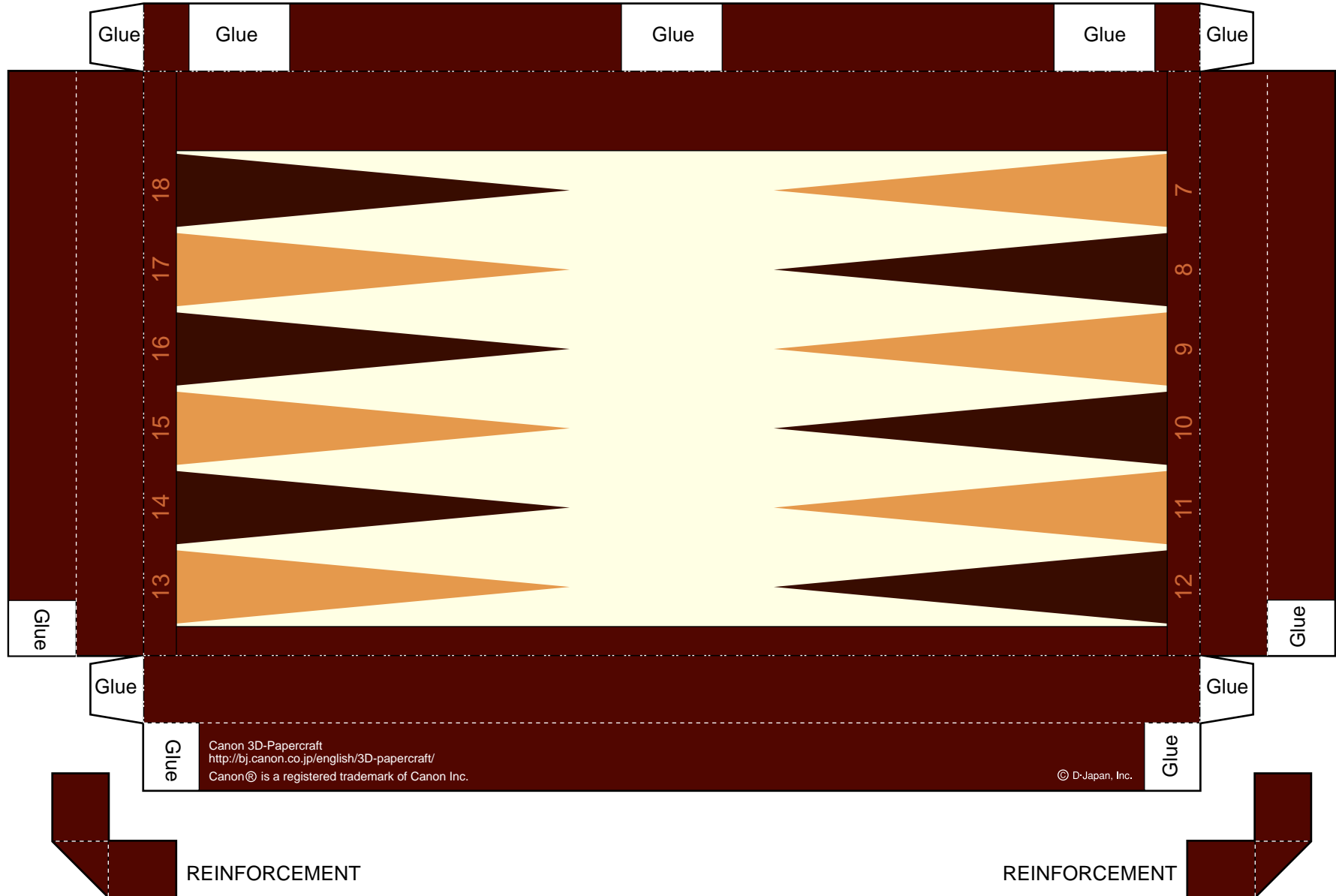

REINFORCEMENT

REINFORCEMENT

- Cut line
- - - Mountain fold line
- - - Valley fold line

GAME BOARD 2

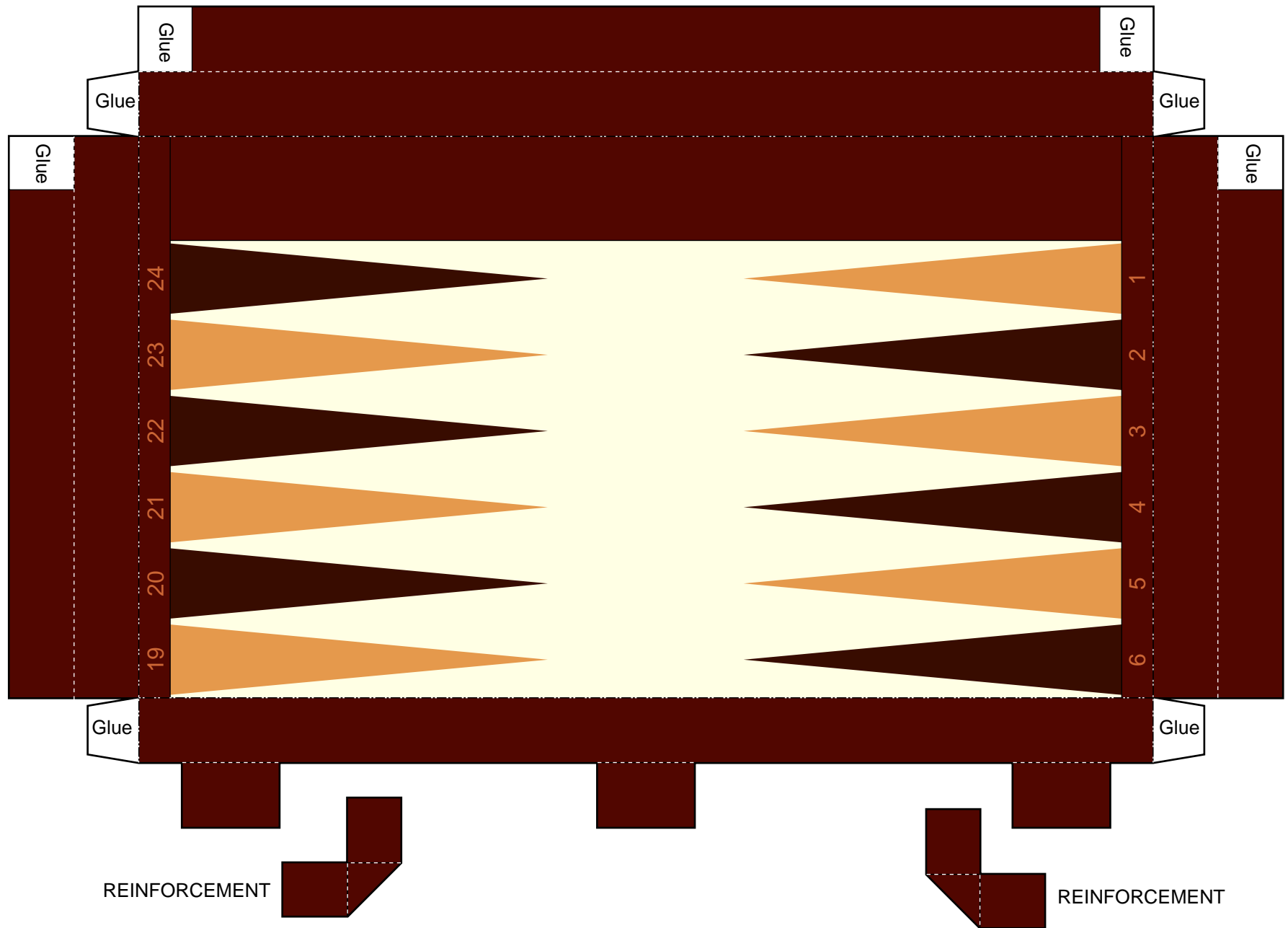

- Cut line
- - - Mountain fold line
- - - Valley fold line

GAME BOARD 3

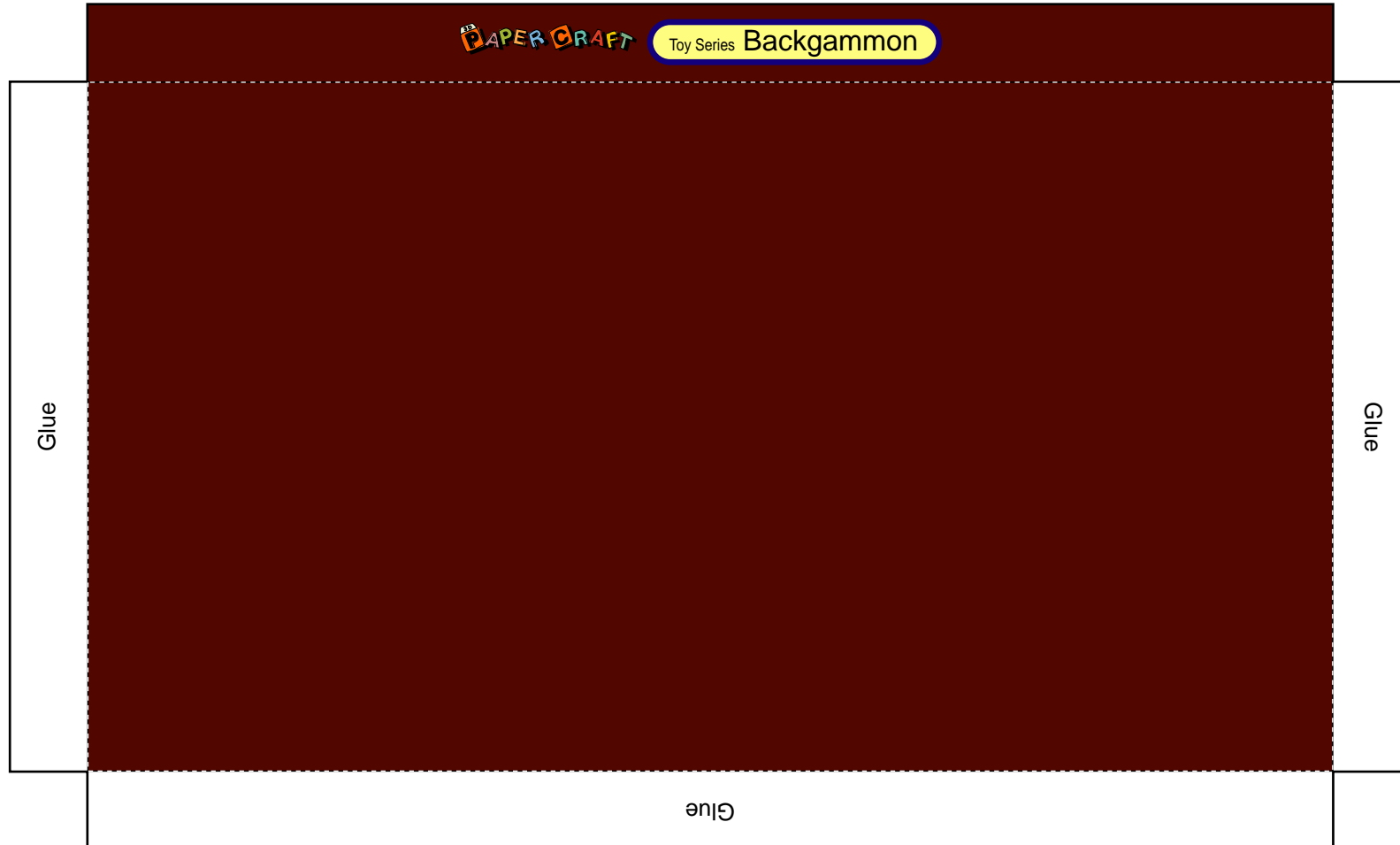

- Cut line
- - - Mountain fold line
- - - Valley fold line

GAME BOARD 4

