

PAPER CRAFT

<http://www.canon.com/c-park/en/>



● View of completed model

Japan Himeji Castle

Situated in Himeji City in Hyogo Prefecture, Himeji Castle is also known as the White Heron Castle because of the way that its soaring, white stucco walls resemble a graceful heron taking flight. The castle sits atop a hill called Himeyama, or Mt. Hime, at an altitude of 45.6m. The very top of the main castle tower, with its five stories and six levels, is 92m above sea level. The first castle at Himeyama was constructed in 1346. Hashiba Hideyoshi later added a three storey tower. The castle in its current form was completed by Ikeda Terumasa in 1610. The castle is full of defensive features, such as narrow passageways that prevent large numbers of attackers from entering en masse, and loopholes through which bows and muskets could be used to repel invaders. However, in its four hundred year history, the castle was never attacked and has survived to this day in its present state. The castle was designated a World Heritage Site by UNESCO in 1993. height of approximately 150 meters above the sea.

* This model was designed for Papercraft and may differ from the original in some respects.



● West face



● South face



● East face



● North face

■ Parts list (Pattern) : Thirteen A4 sheets (No.1 to No.13)

■ No. of Parts : 123

■ Assembly Instructions : Seven A4 sheets (No.1 to No.7)

* Build the model by carefully reading the Assembly Instructions , in the parts sheet page order.

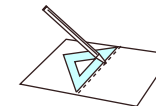

★ Hint: Trace along the folds with a ruler and a used pen (no ink) to get a sharper, easier fold.

Assembly Instructions

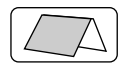

----- **Mountain fold (dotted line)**

● Make a mountain fold.

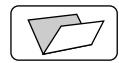

- - - - - **Valley fold (dashed and dotted line)**

● Make a valley fold.

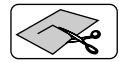

———— **Scissors line (solid line)**

● Cut along the line.

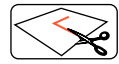

———— **Cut in line (solid line)**

● Cut along the line.

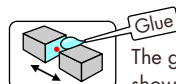

The glue spot (colored dot) shows where to apply the glue.

● **Glue spot (Red dot)**
Glue parts with the same number together.

● **Glue spot (Green dot)**
Glue within the same part.

● **Glue spot (Blue dot)**
Glue to the rear of the other part.

Tools and materials



● Scissors, set square, glue (We recommend stick glue), pencil, used ballpoint pen, toothpicks, tweezers, (useful for handling small parts)

Assembly tip



● Before gluing, crease the paper along mountain fold and valley fold lines and make sure rounded sections are nice and stiff.

Caution



● Glue, scissors and other tools may be dangerous to young children so be sure to keep them out of the reach of young children.

■ Before starting.

- There is a sheet number (No.1 to No.13) printed at the bottom center of each Pattern page. Assemble the model in the order of the page numbers. (*Assembly parts are on sheets No. 2 to No. 13.)
- There are a total of 123 parts and each sheet carries a parts symbol. The 'glue spot' on each part bears the number of the part to which it should be glued.
- The numbers ①②③, etc., on each part indicate the order in which they are to be glued.
- Where there are multiple joints within a single part, or 'glue spots' where the part is to be glued to another, there are colors ●●● and numbers to give detailed instructions as to the correct positions.

Sheet No.2

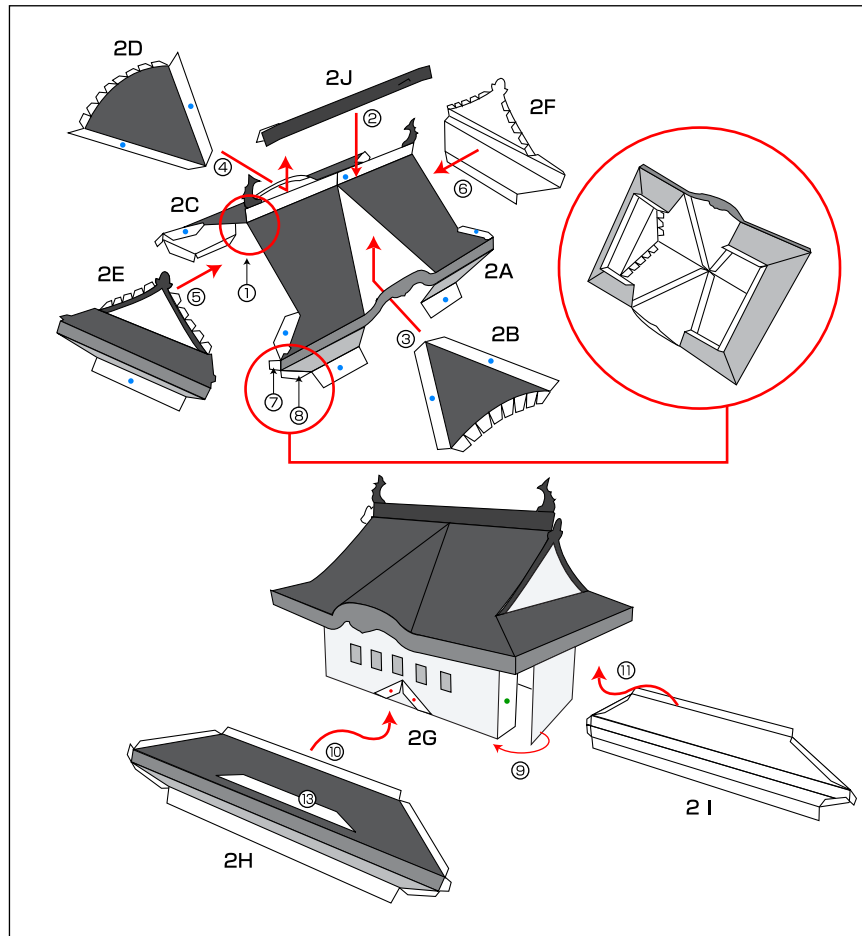

Sheet No.3

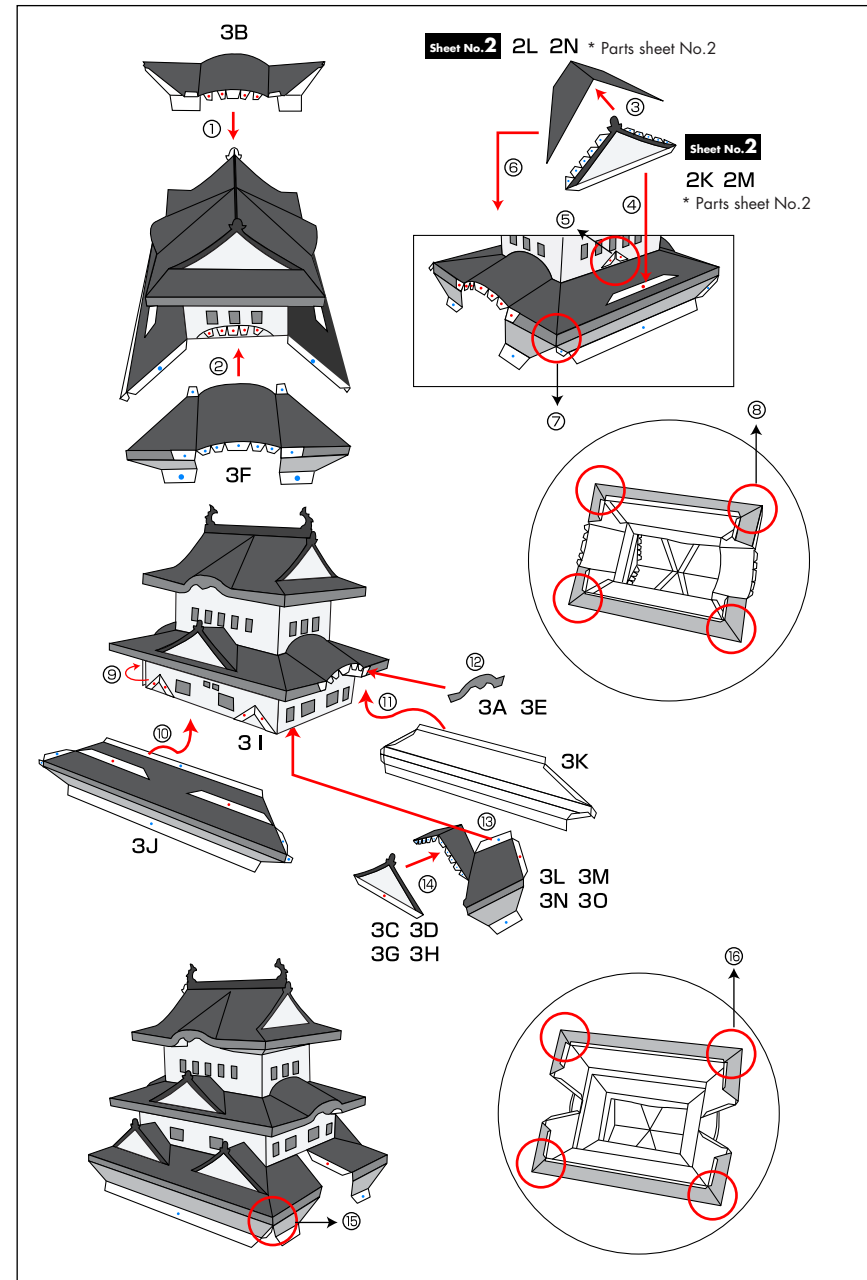

Sheet No.4

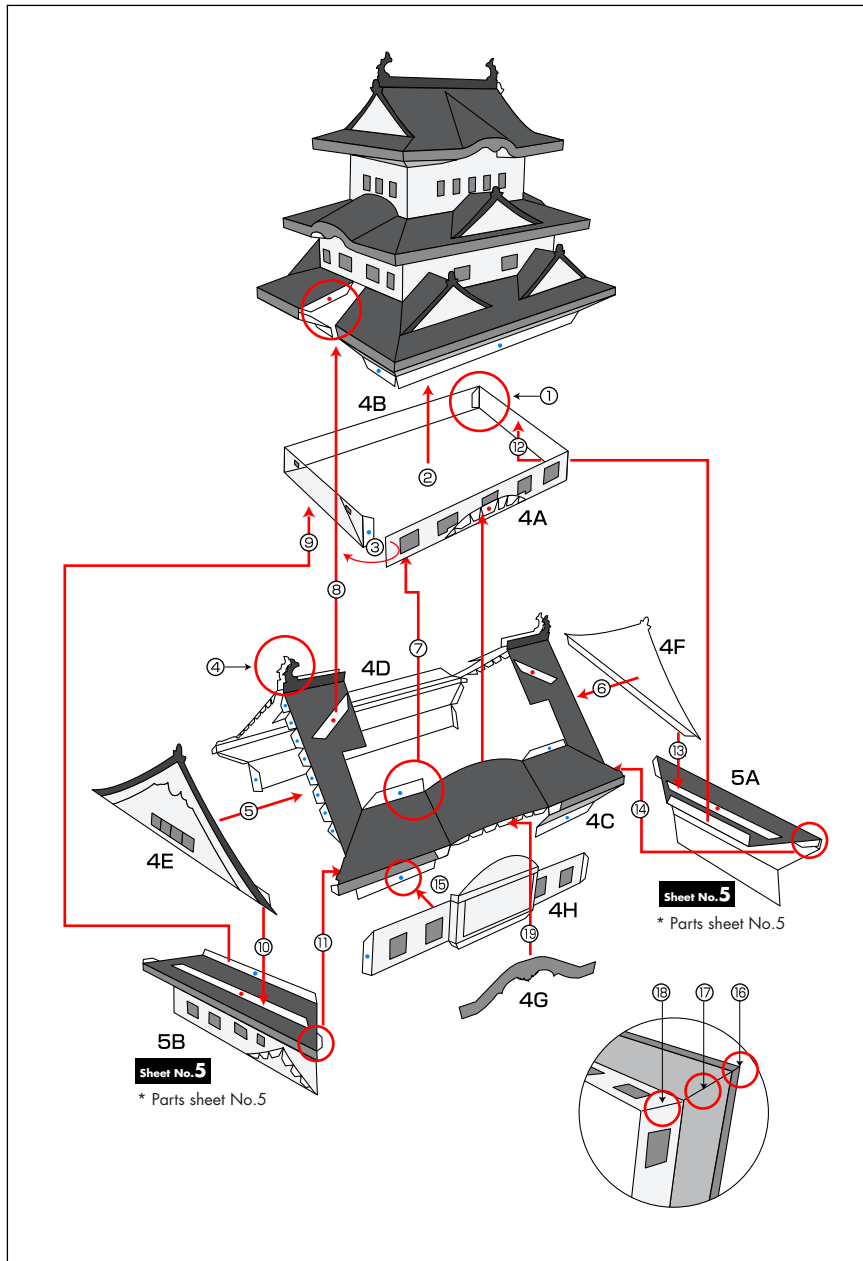

Sheet No.5

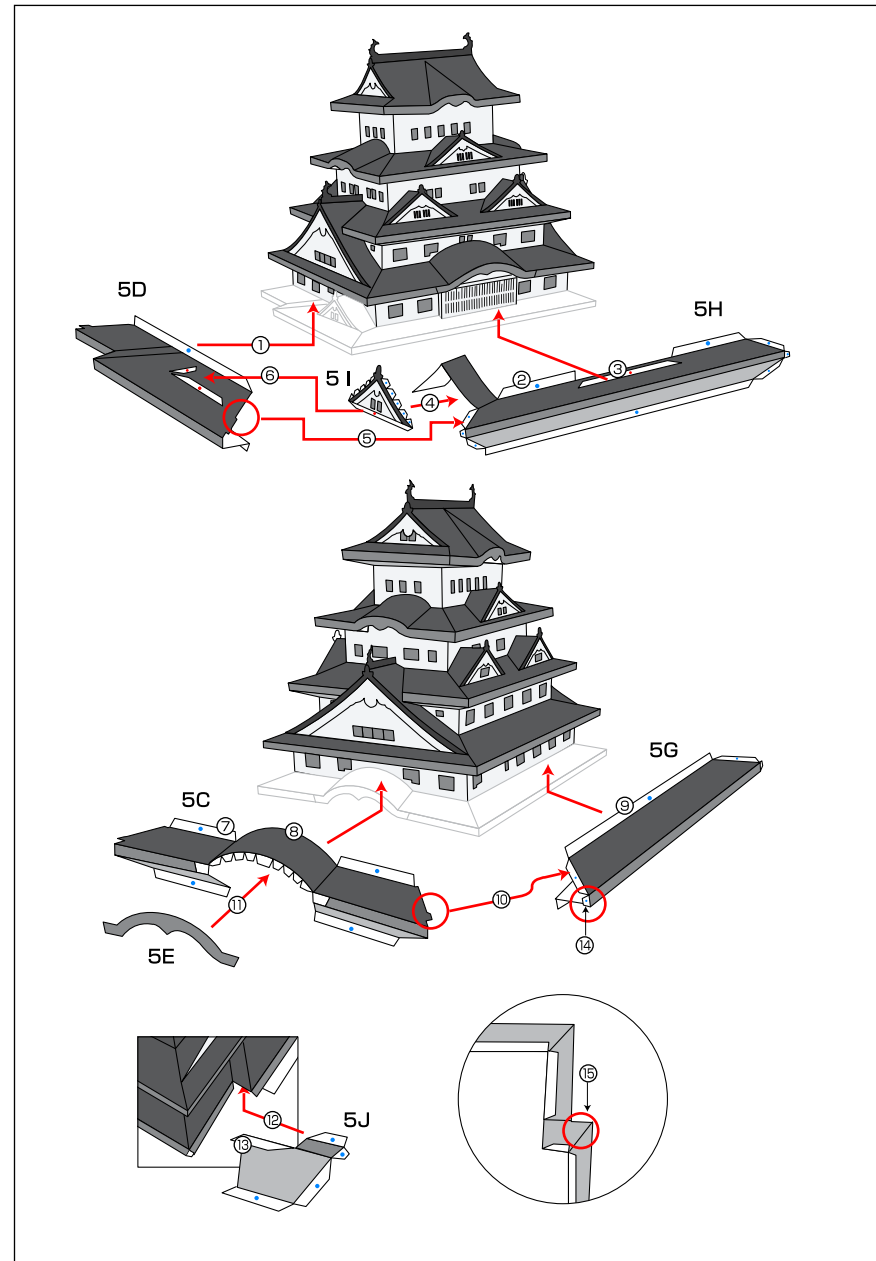

Sheet No.4·5·6·7

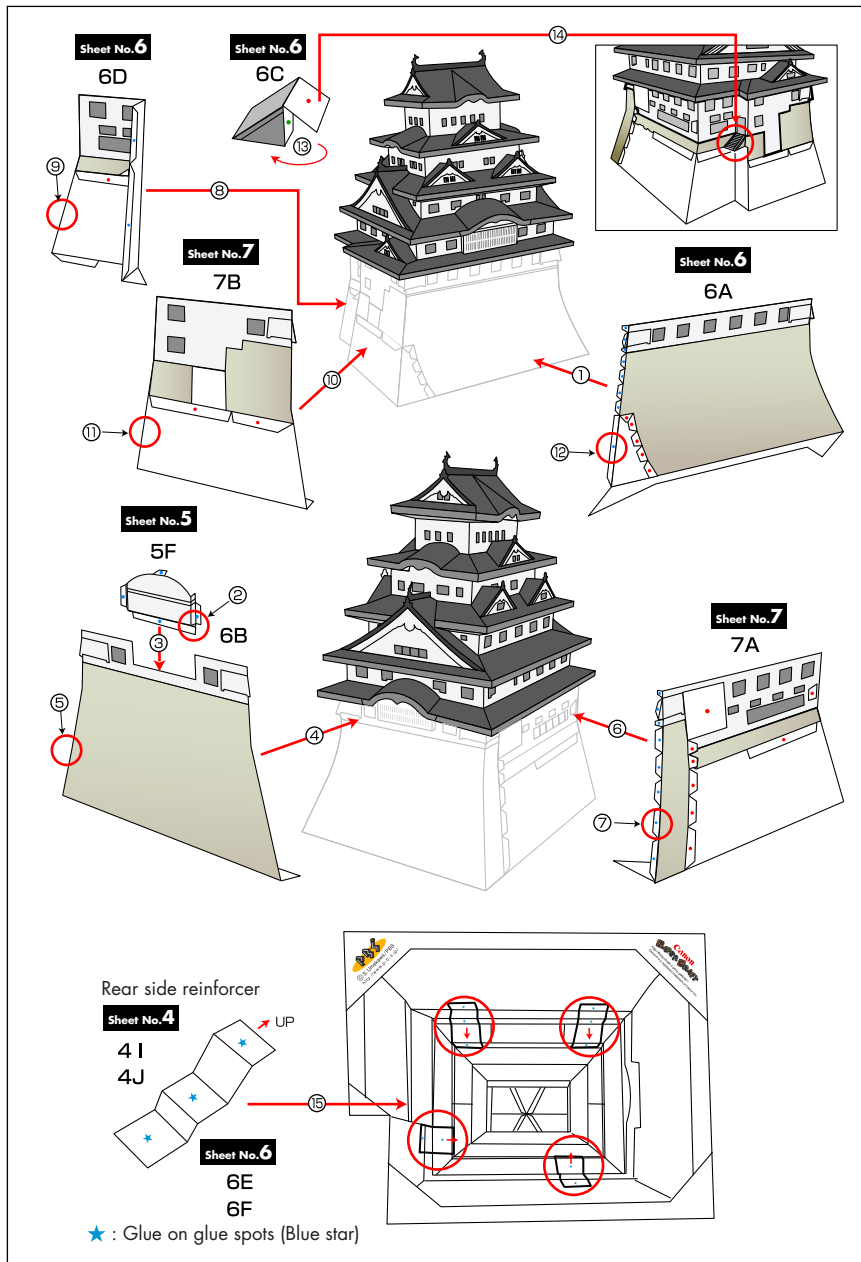

Sheet No.7·8

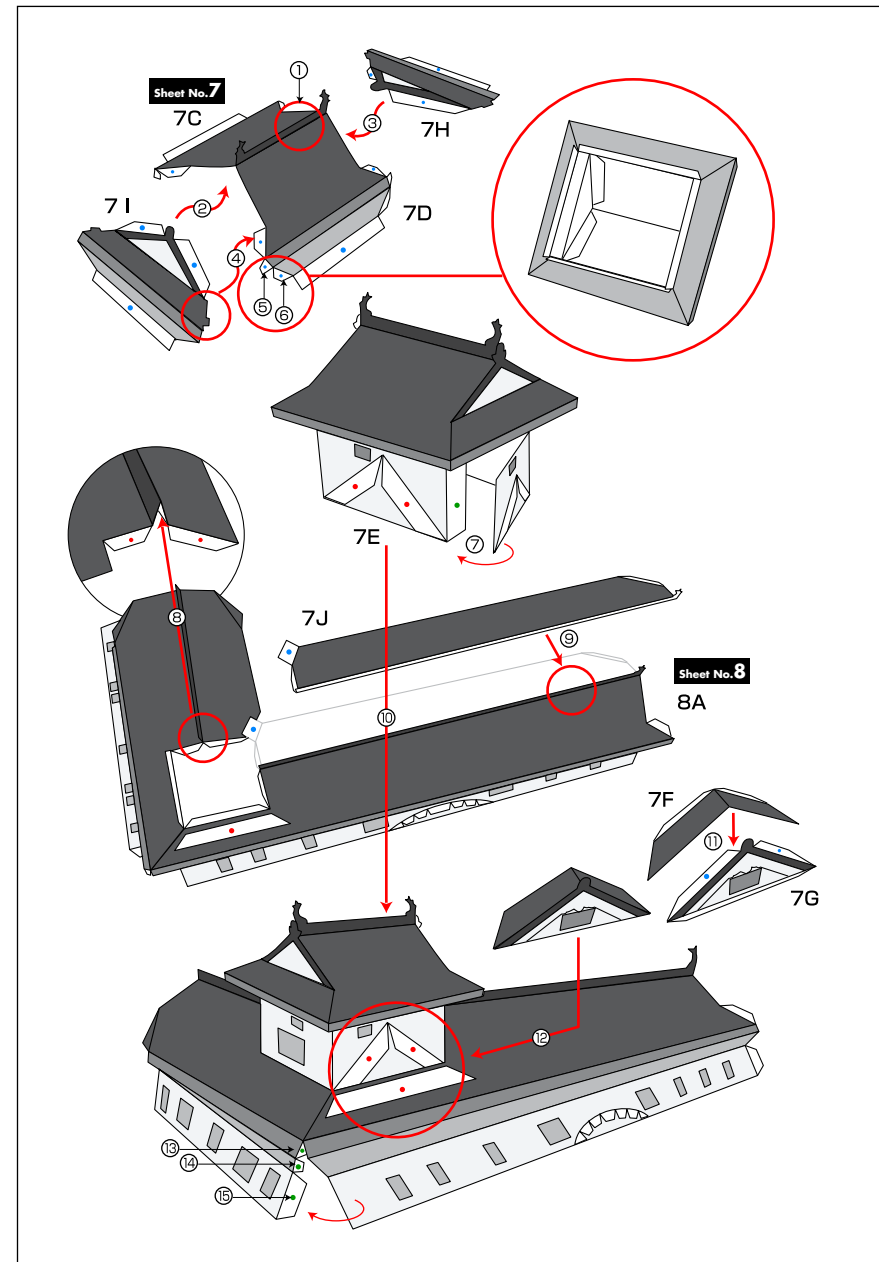

Sheet No. 8 · 9

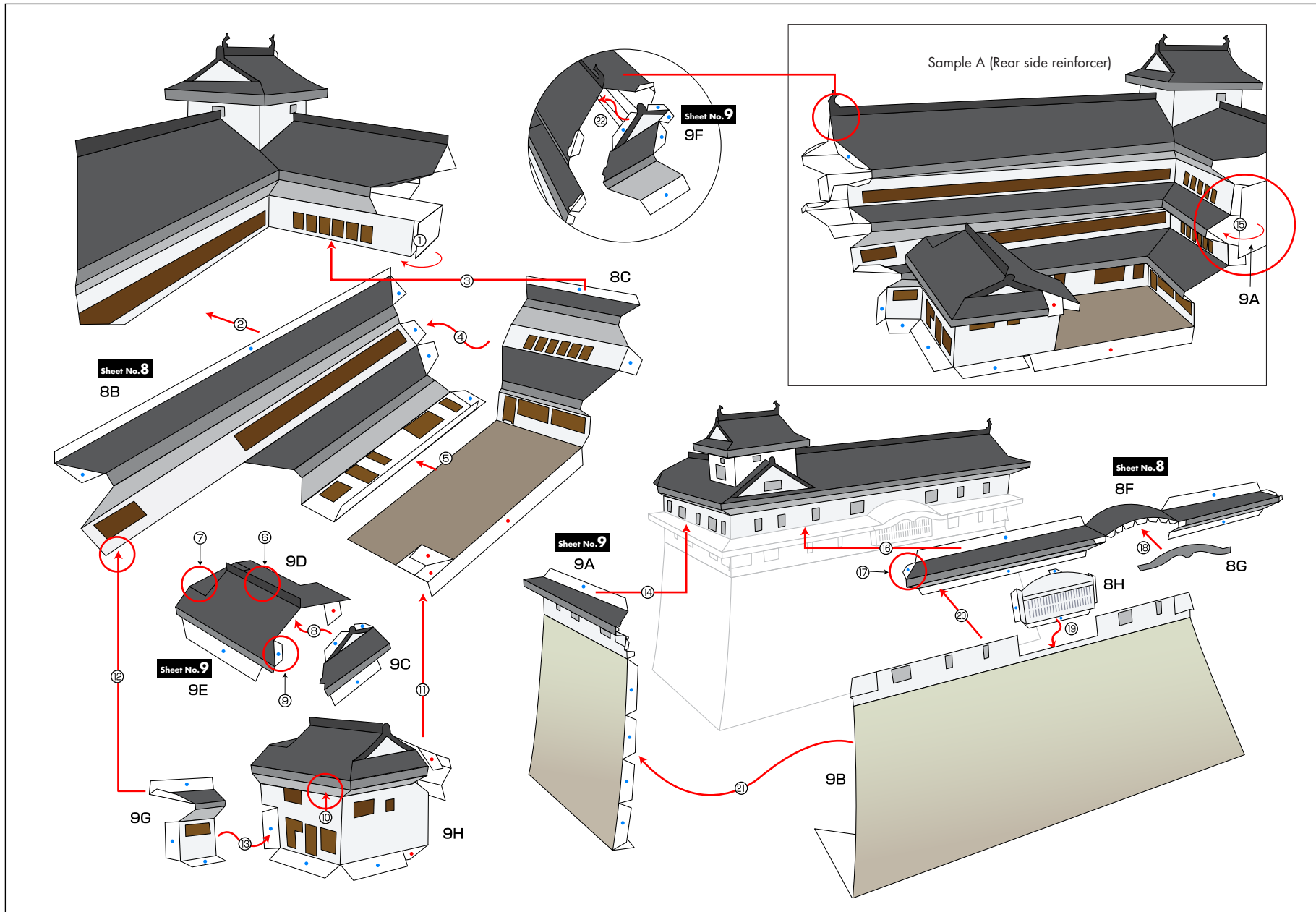

Rear side reinforcer

Sheet No. 8

8D

8E

★ : Glue on glue spots (Blue star)

Refer to Sample A (Rear side reinforcer) of parts sheet No.5 (Assembly Instructions).

Sheet No. 10

Sheet No. 10 · 11 · 12

Sheet No. 12

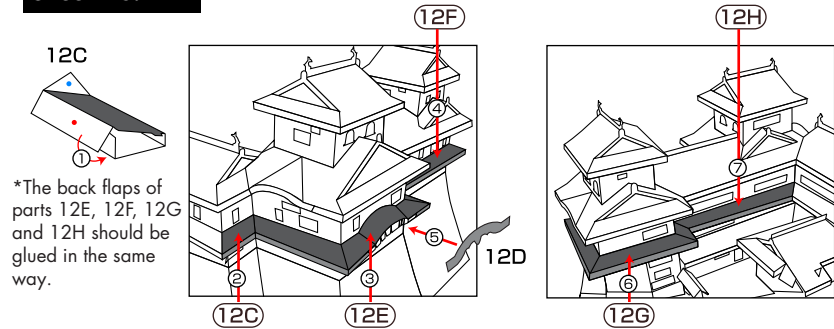

Sheet No. 13

