

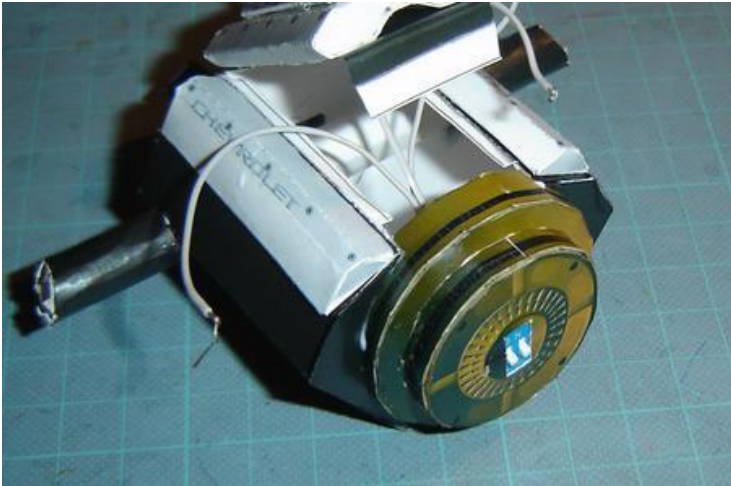

step008



step012



step009



step013

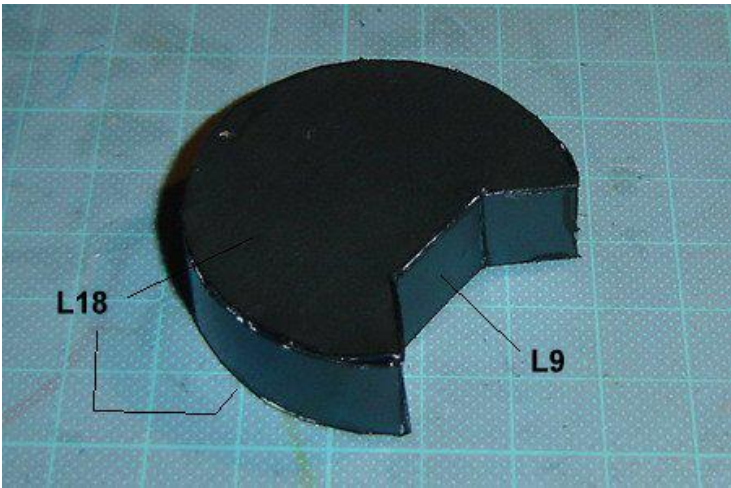

step010

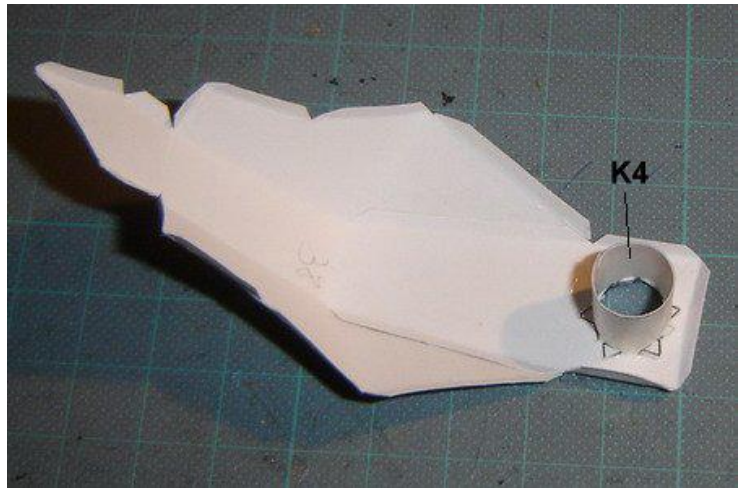

step014

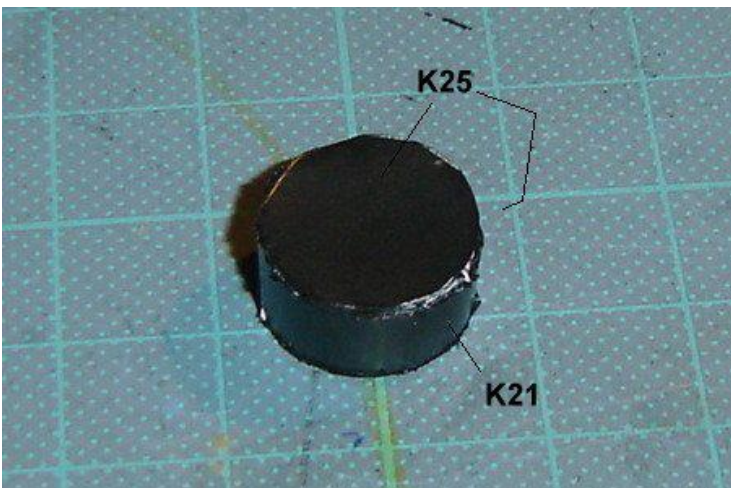

step011

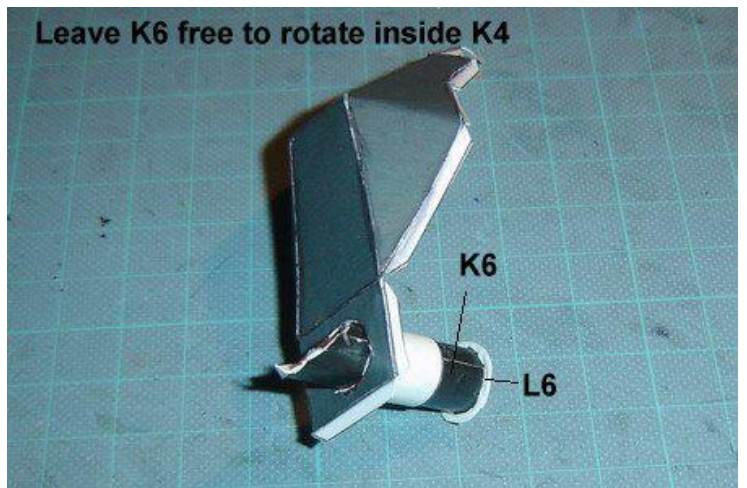

step015

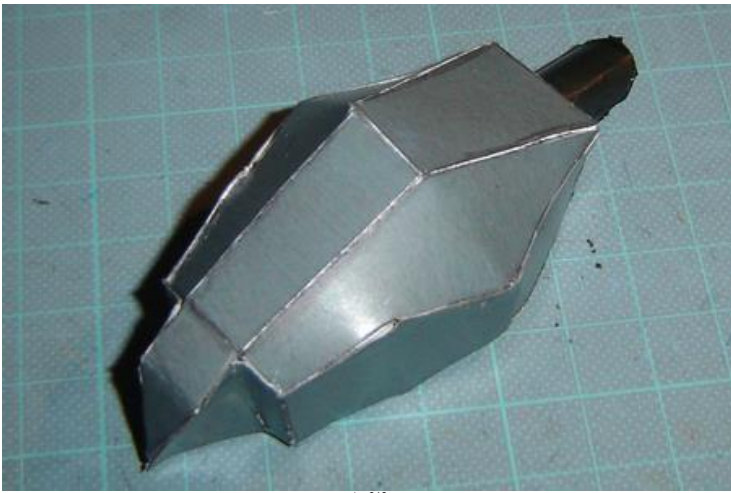

step016

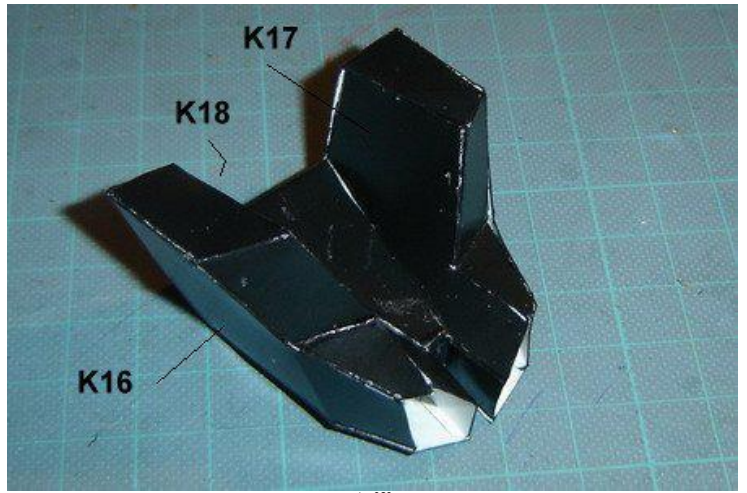

step020



step017

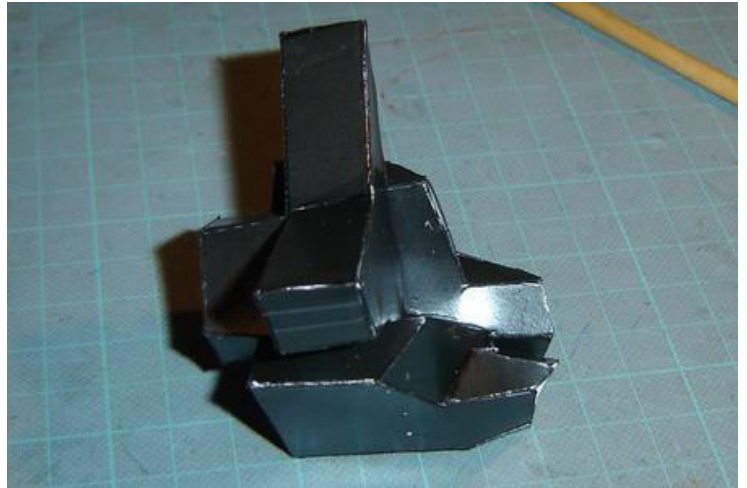

step021



step018



step021a

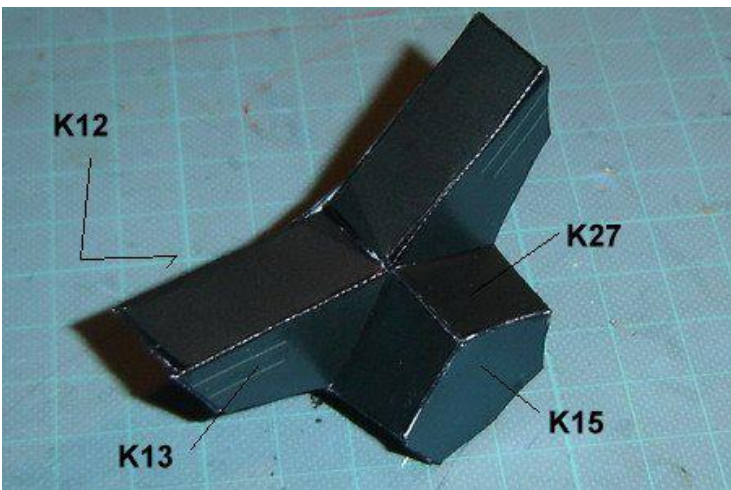

step019



step022



step023



step026



step024



step027



step024a

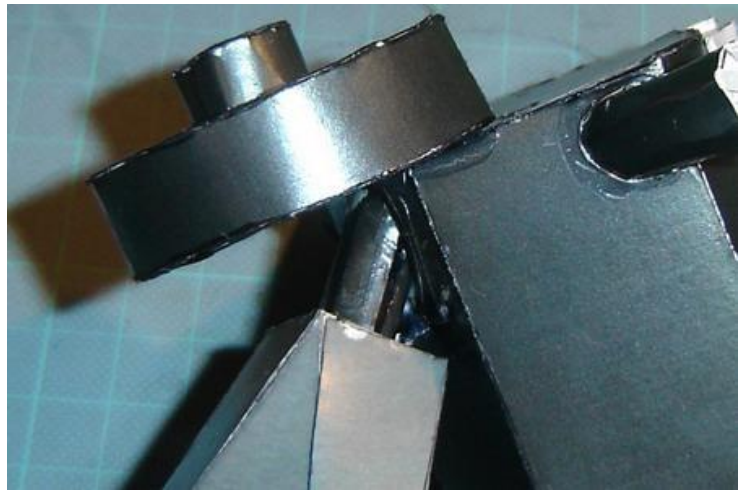

step028



step025

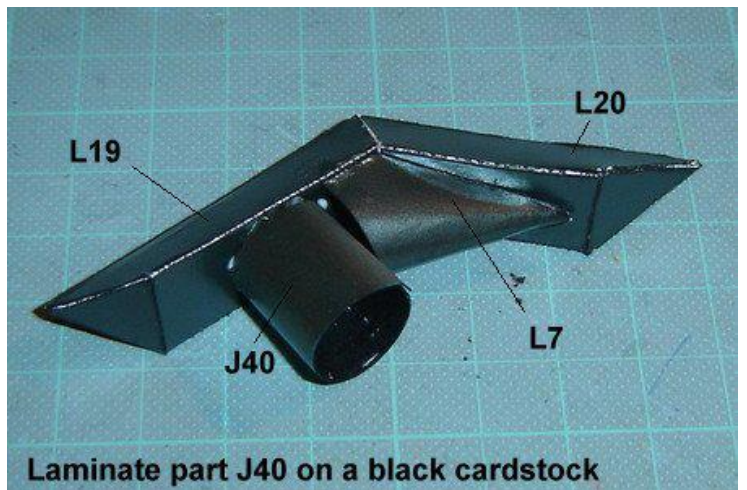

step029

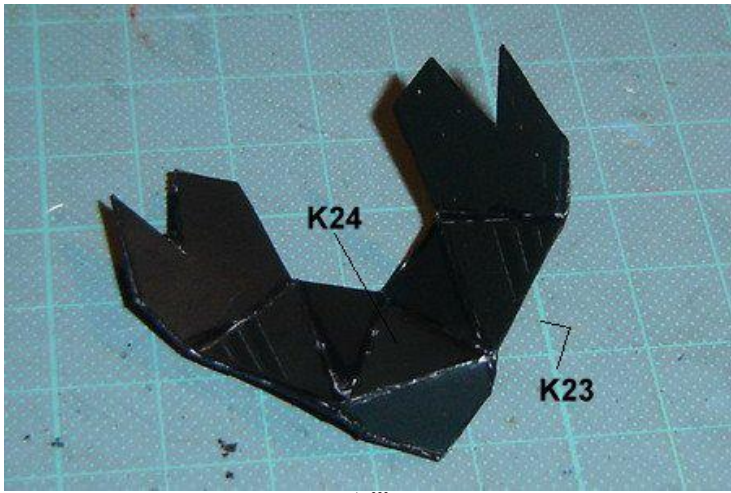

step030

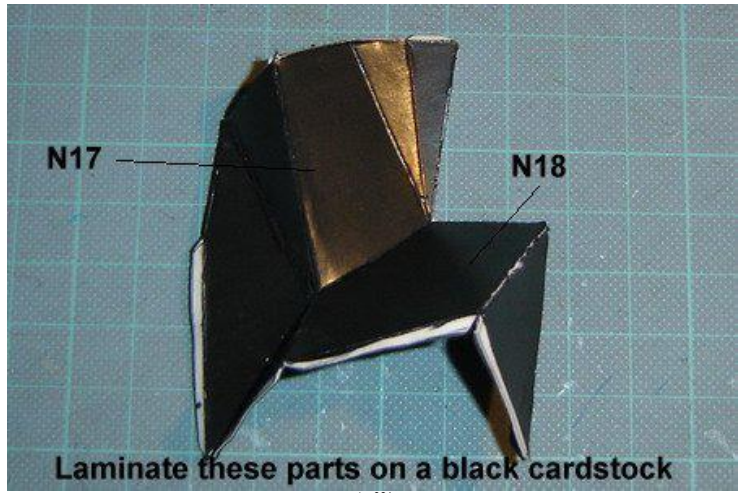

step034



step031

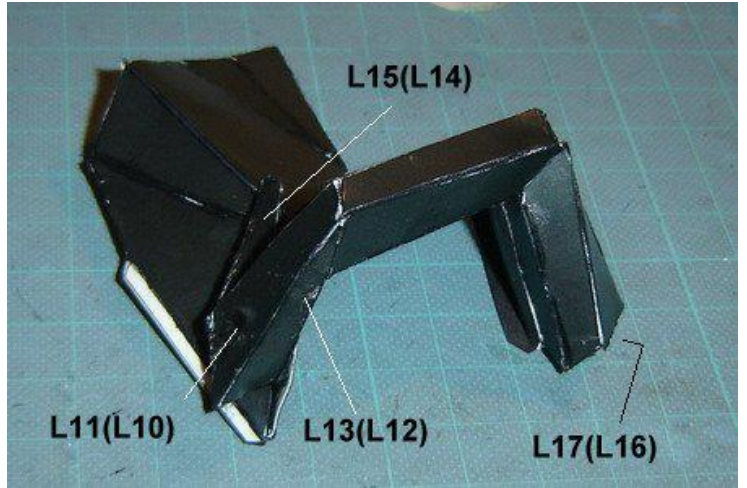

step035

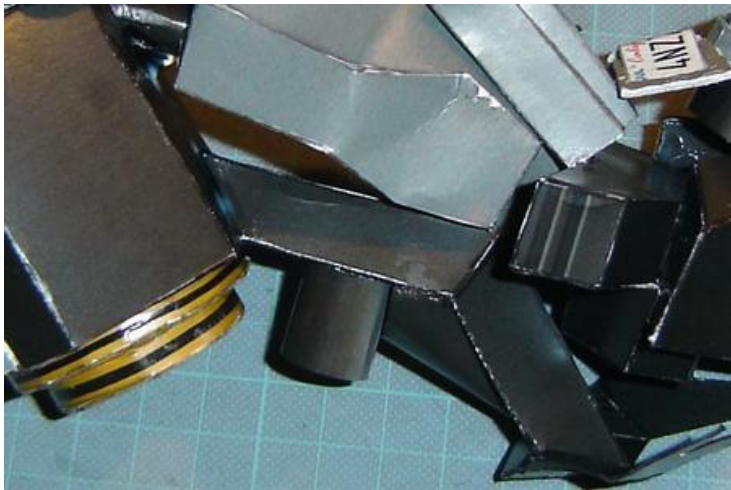

step032

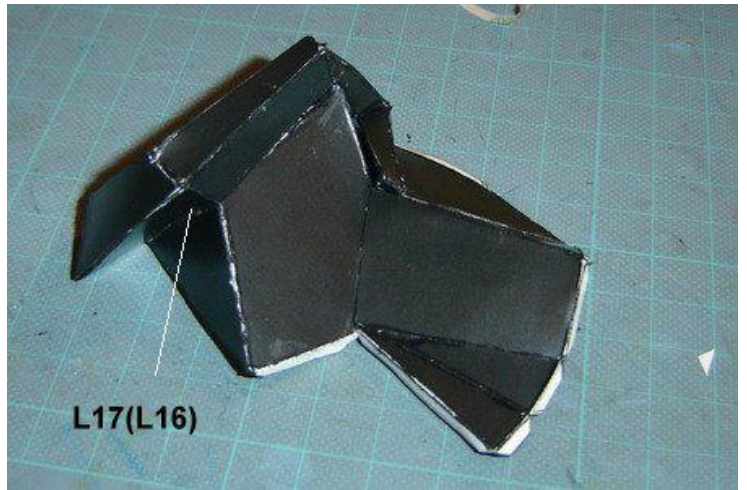

step035a



step033

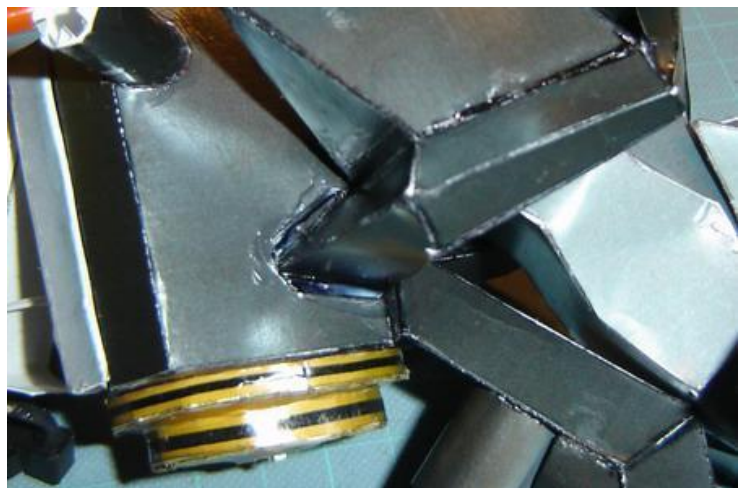

step036

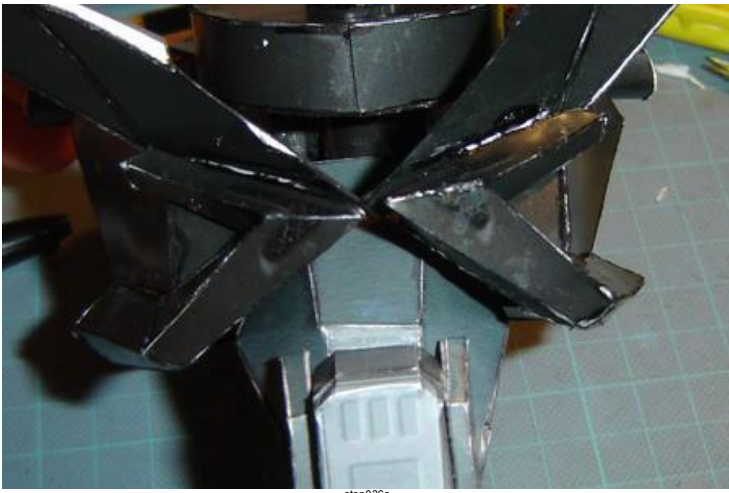

step036a

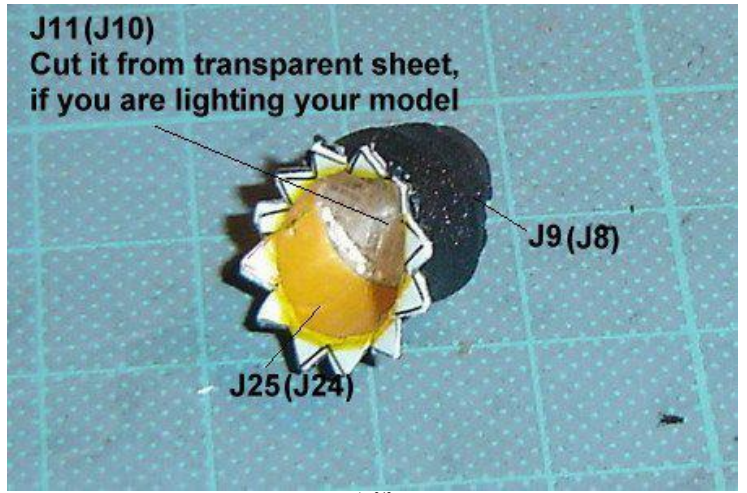

J11(J10)
Cut it from transparent sheet,
if you are lighting your model

J9(J8)

J25(J24)

step040

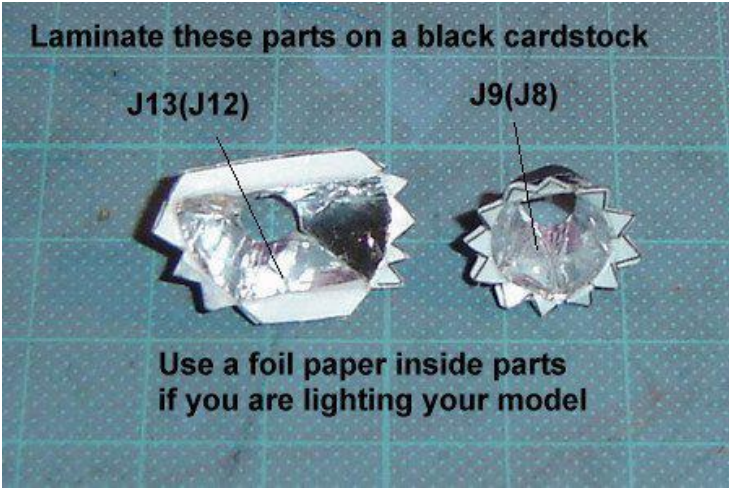

Laminate these parts on a black cardstock

J13(J12)

J9(J8)

**Use a foil paper inside parts
if you are lighting your model**

step037

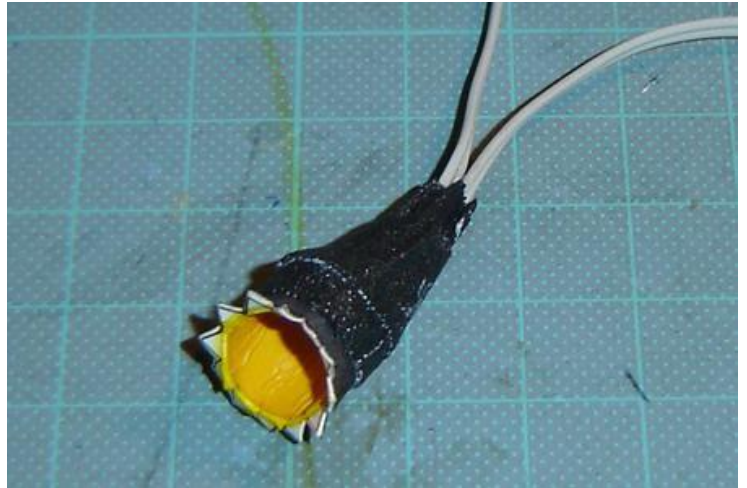

step041

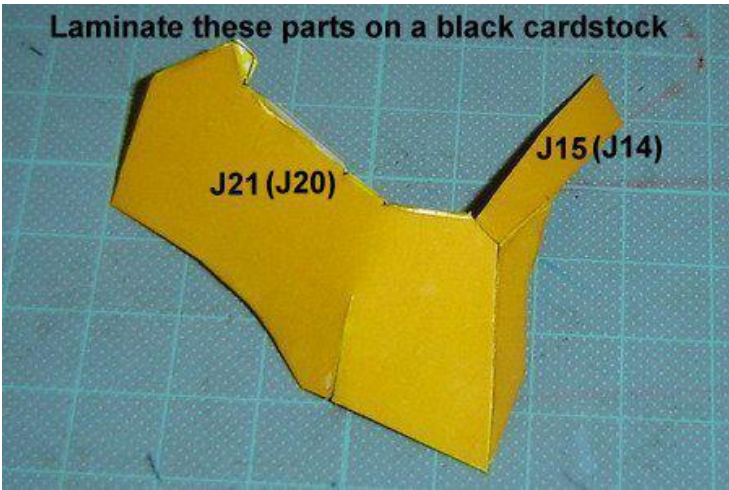

Laminate these parts on a black cardstock

J21(J20)

J15(J14)

step038

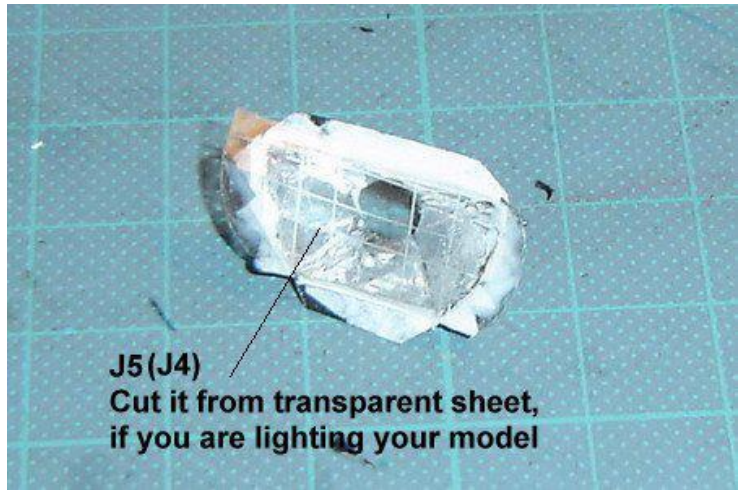

J5(J4)
Cut it from transparent sheet,
if you are lighting your model

step042

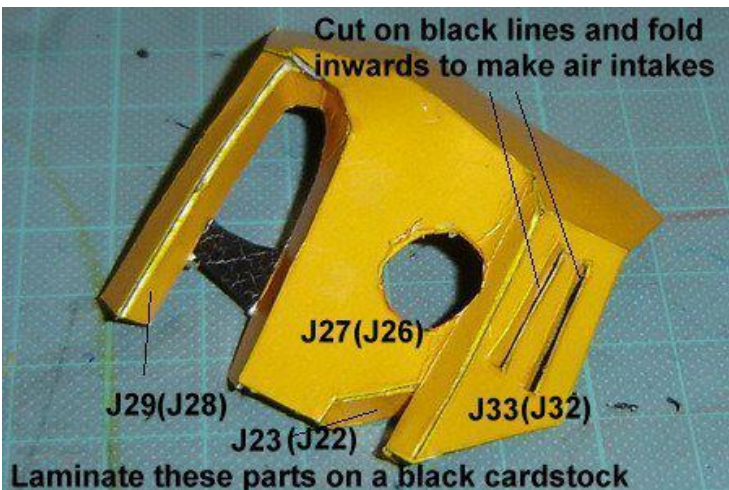

**Cut on black lines and fold
inwards to make air intakes**

J27(J26)

J29(J28)

J23(J22)

J33(J32)

Laminate these parts on a black cardstock

step039



step043



step044



step047



step045



Laminate these parts on a black cardstock

step048

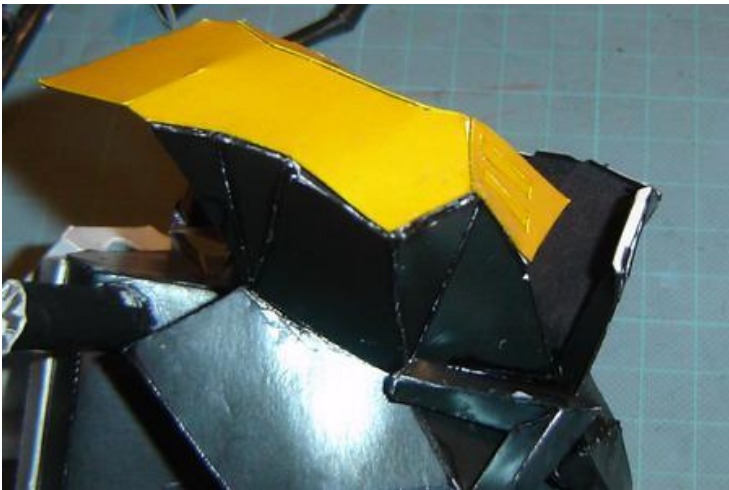

step045a

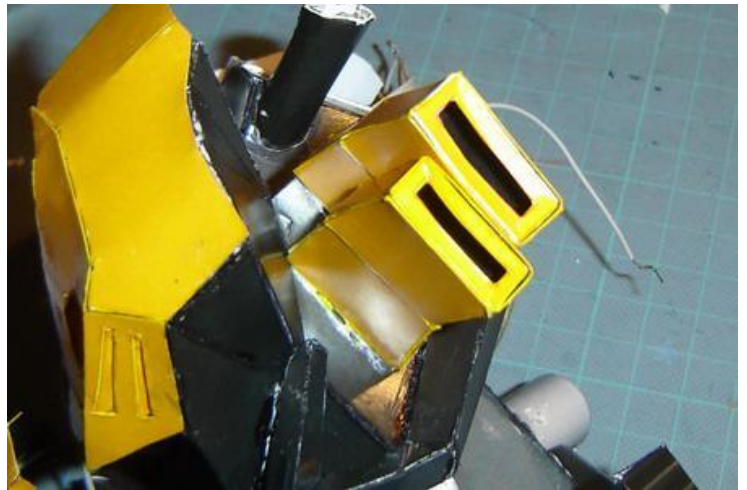

step049



Insert wires into little hole made at step001

step046

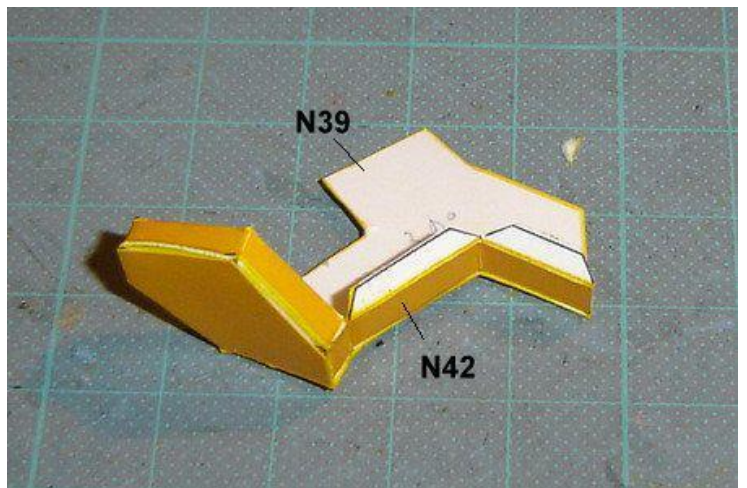

step050

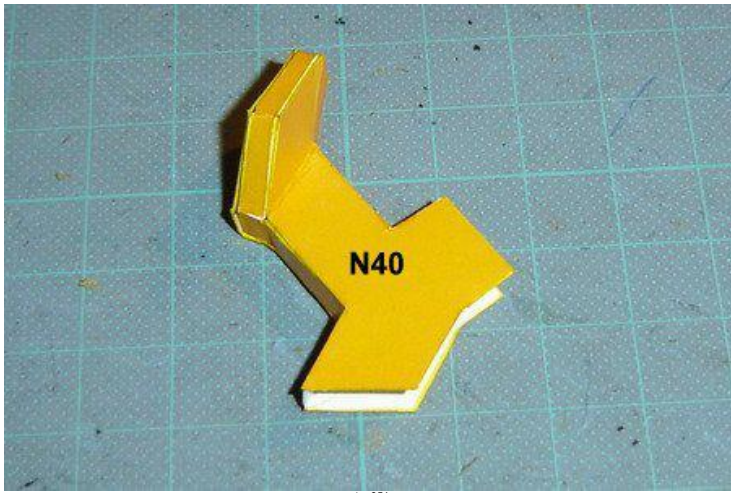

step051

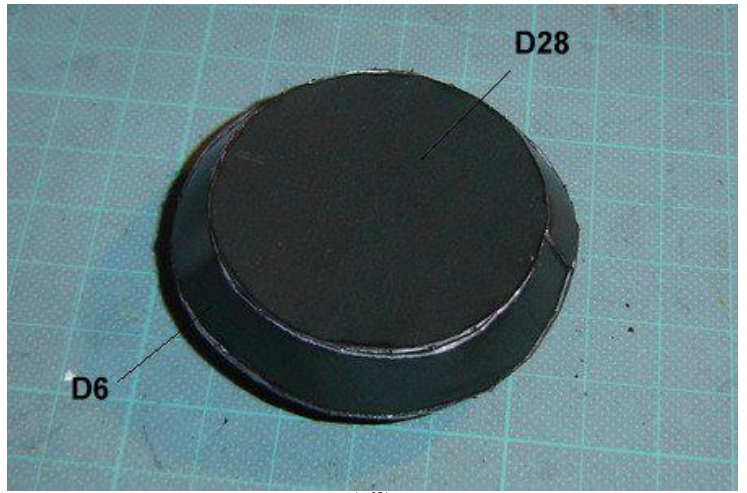

step054a

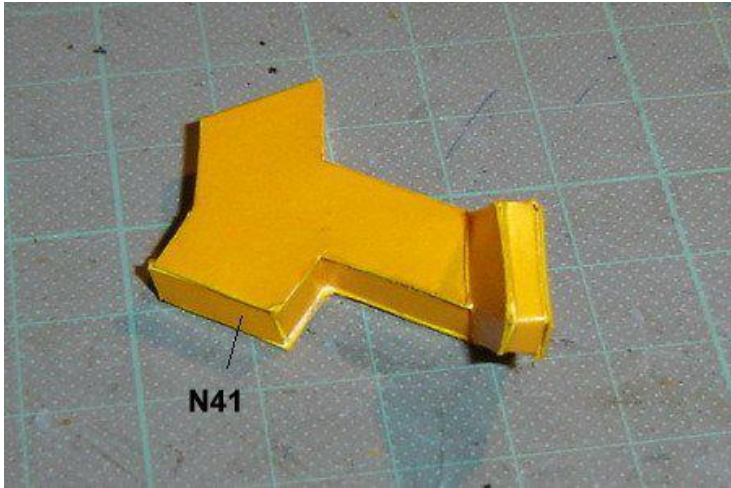

step052

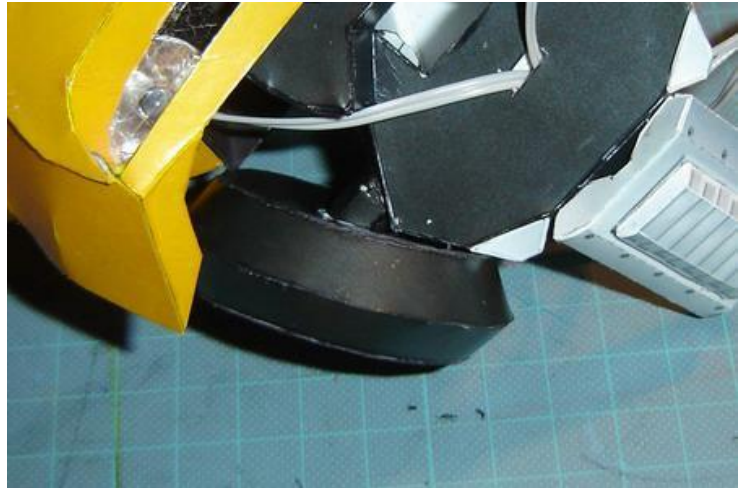

step055

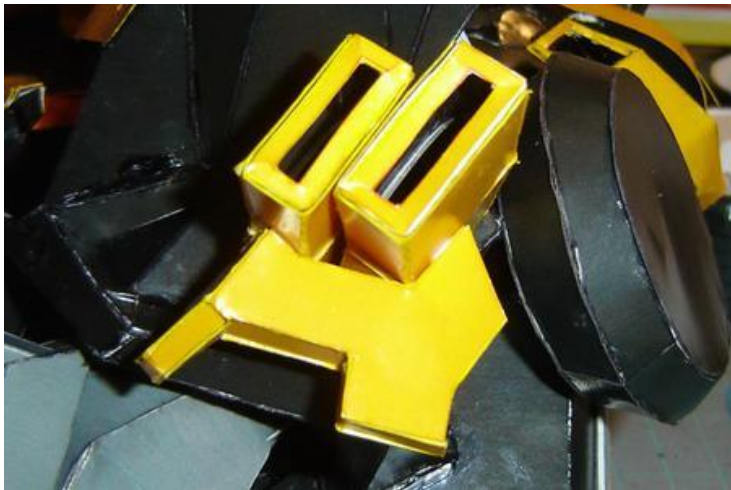

step053

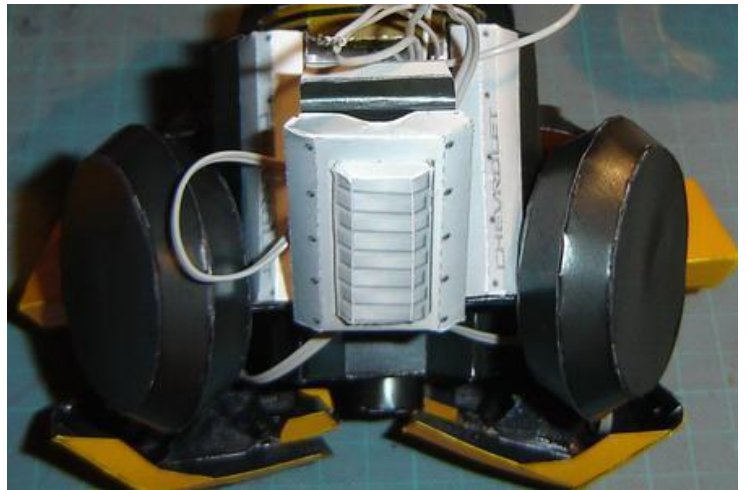

step055a



step054

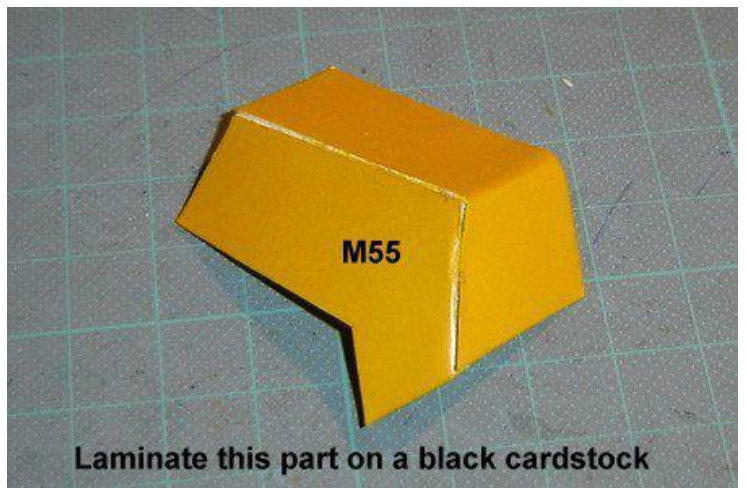

Laminate this part on a black cardstock

step056

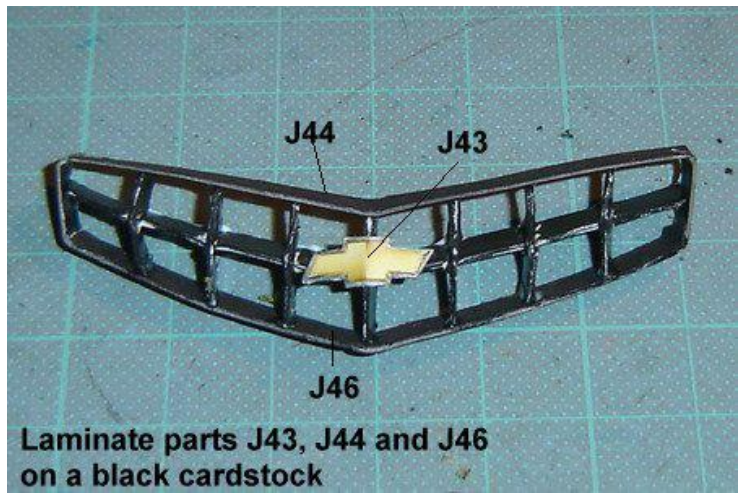
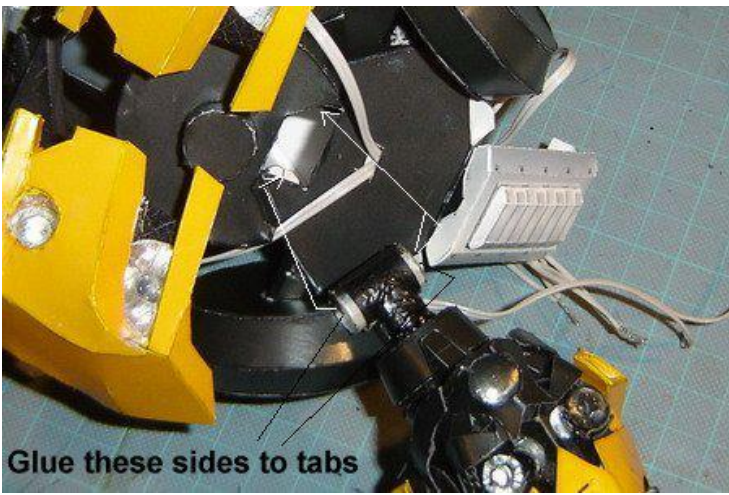
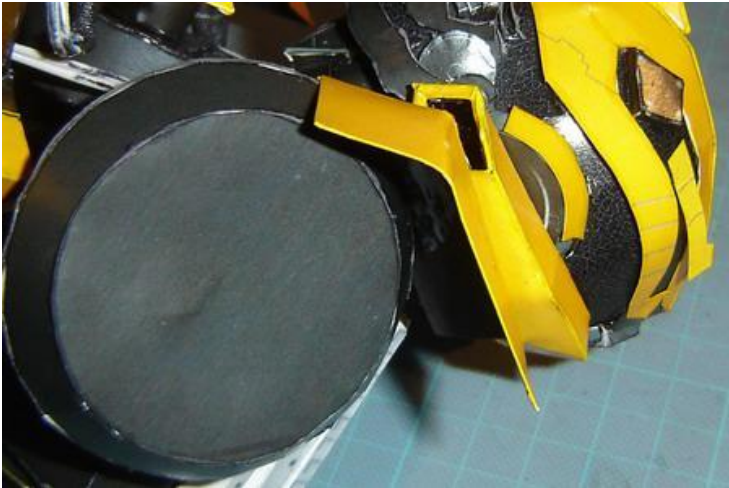
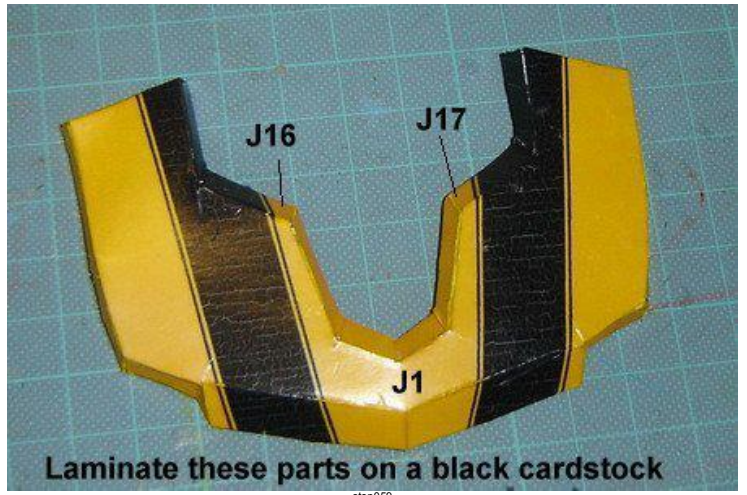
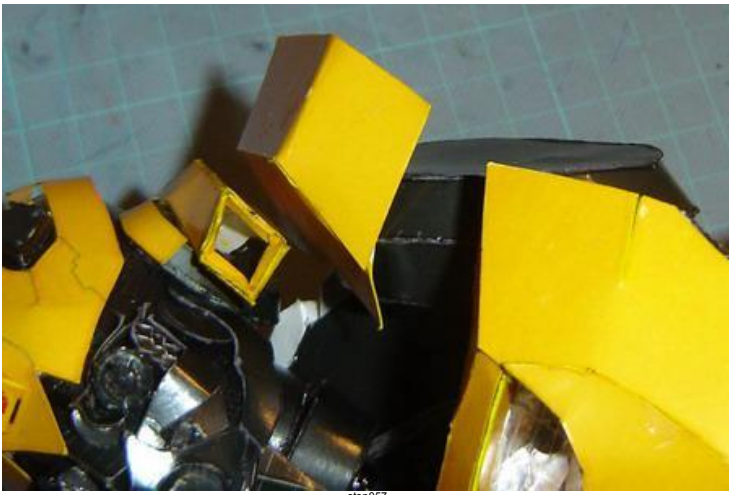



step063

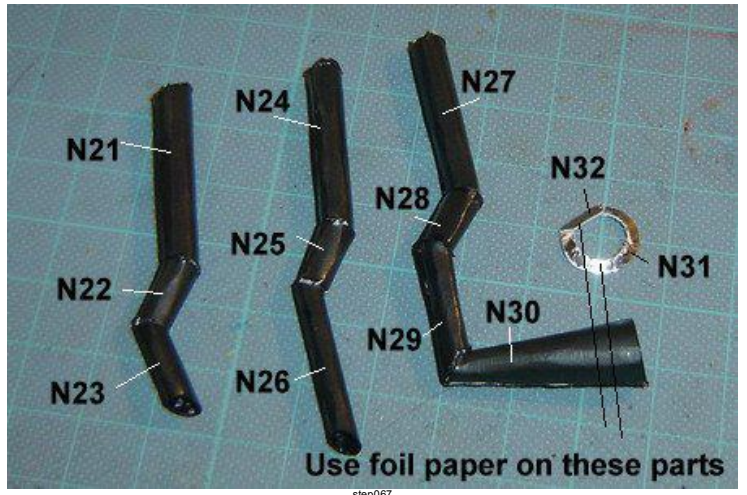

Use foil paper on these parts

step067

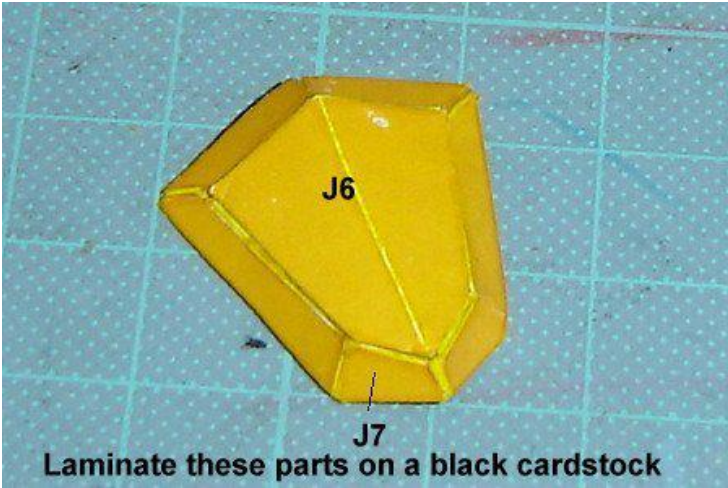

Laminate these parts on a black cardstock

step064



step068



step065



step069

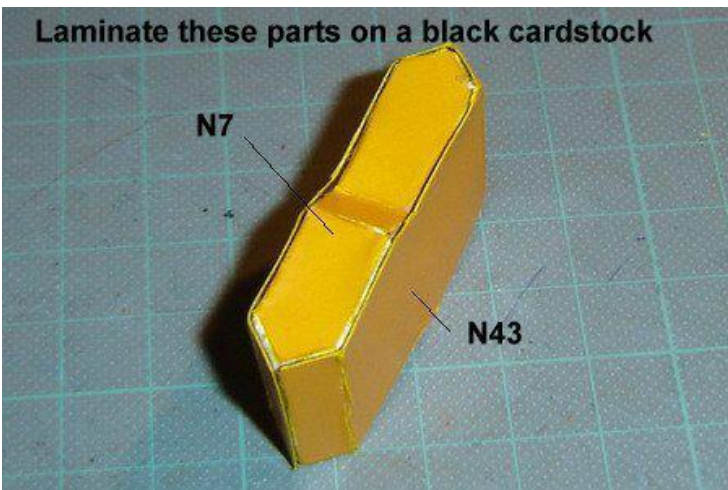

Laminate these parts on a black cardstock

step066



step070

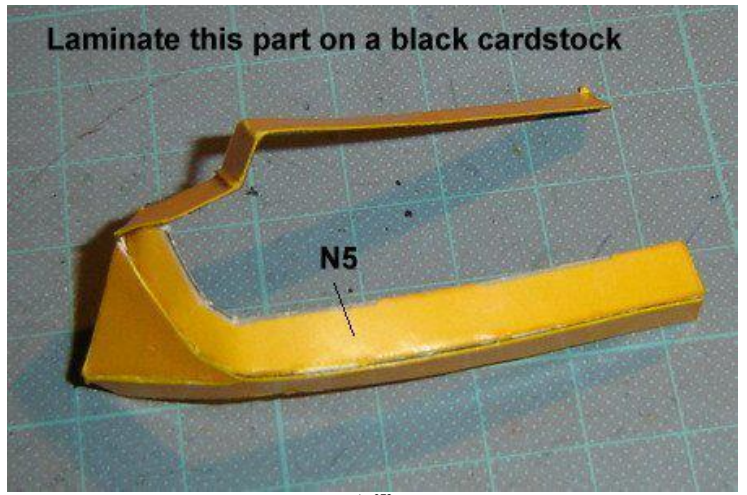
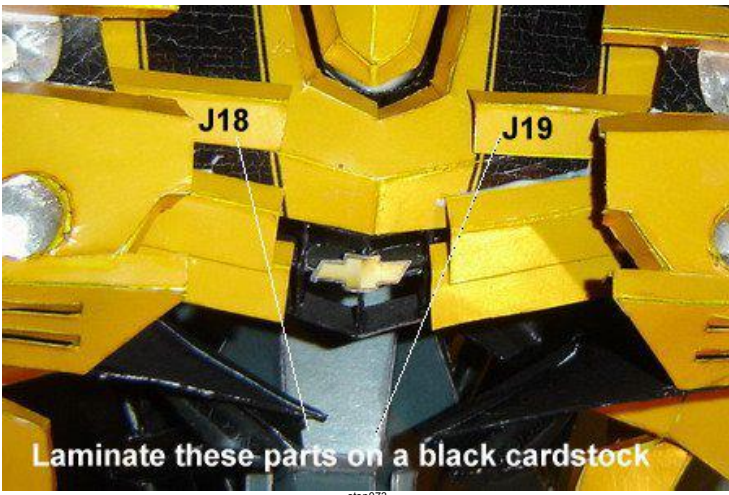
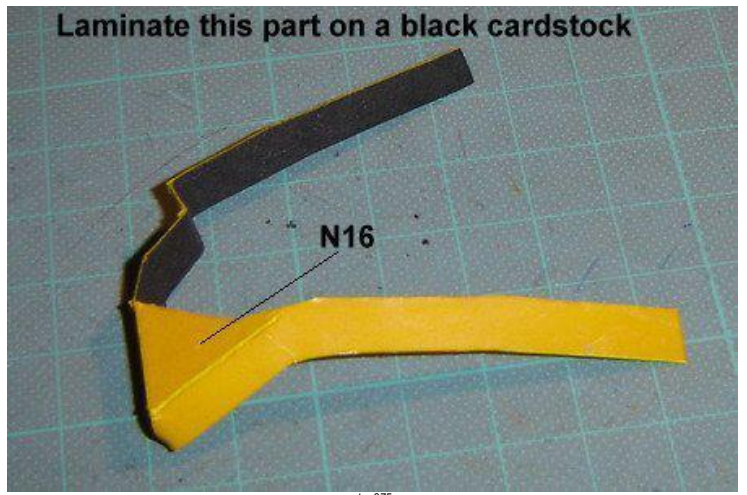
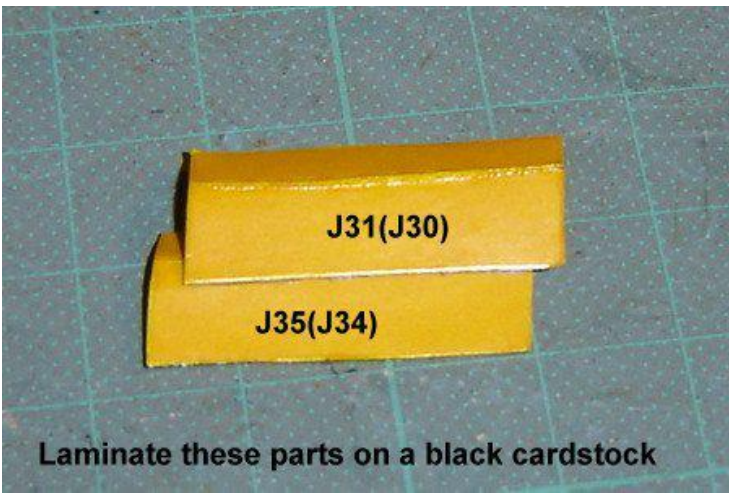
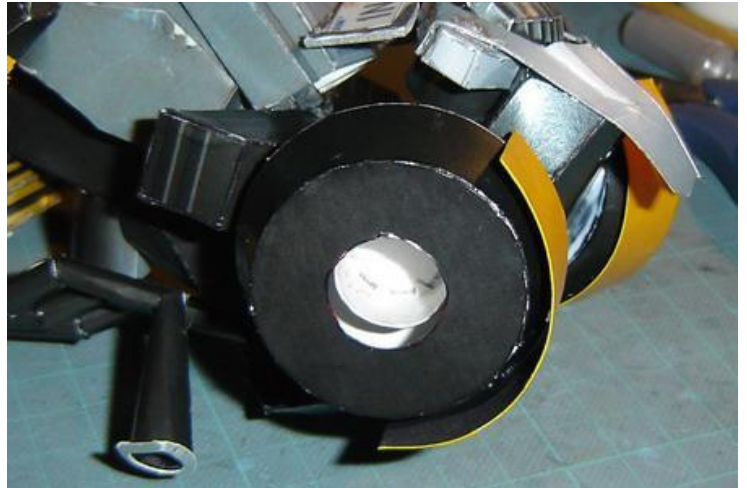
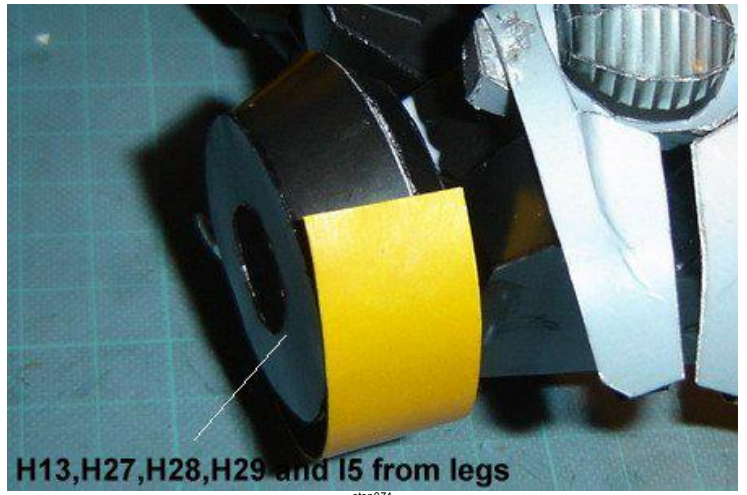
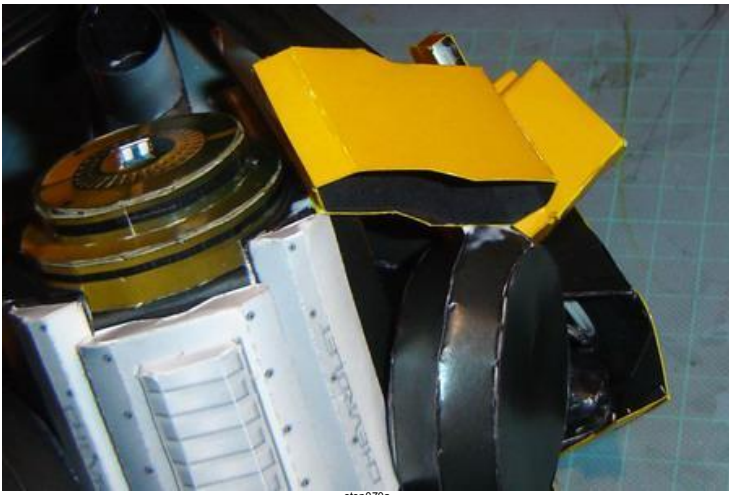

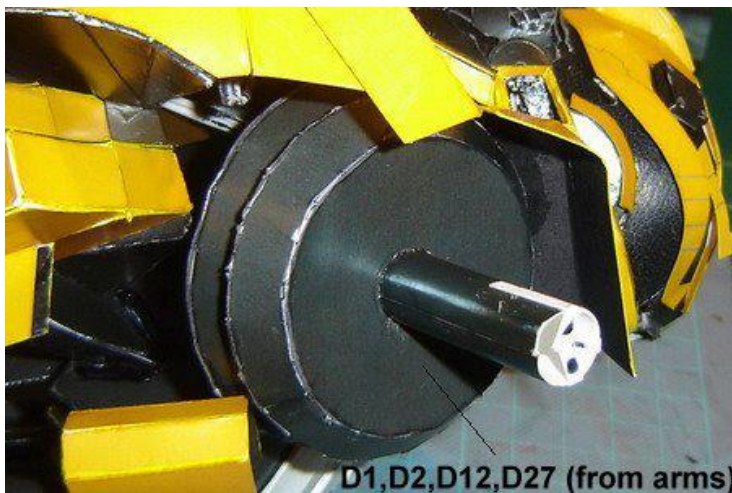
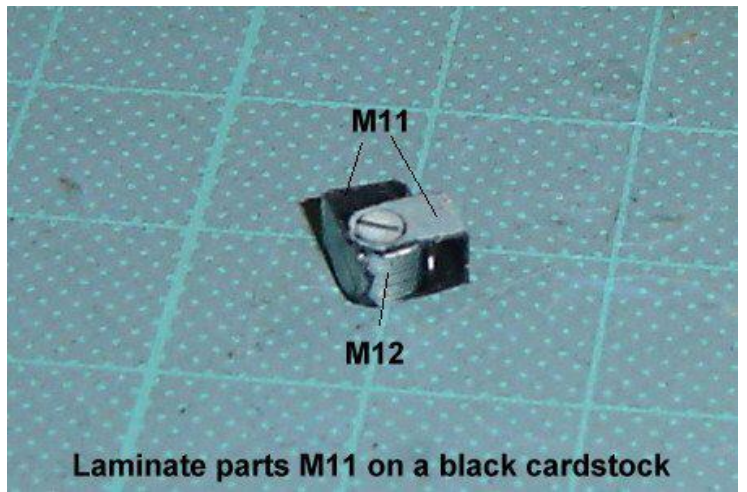
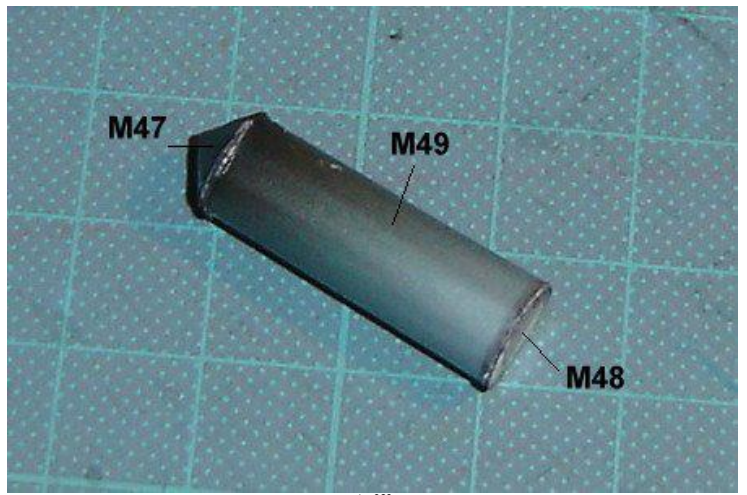
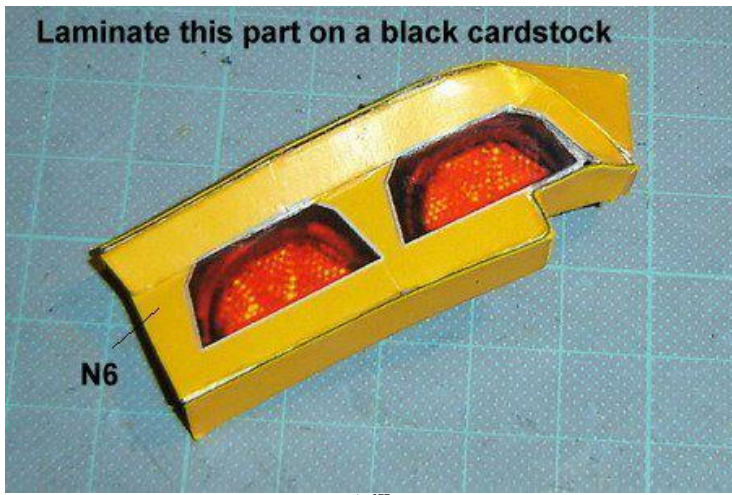

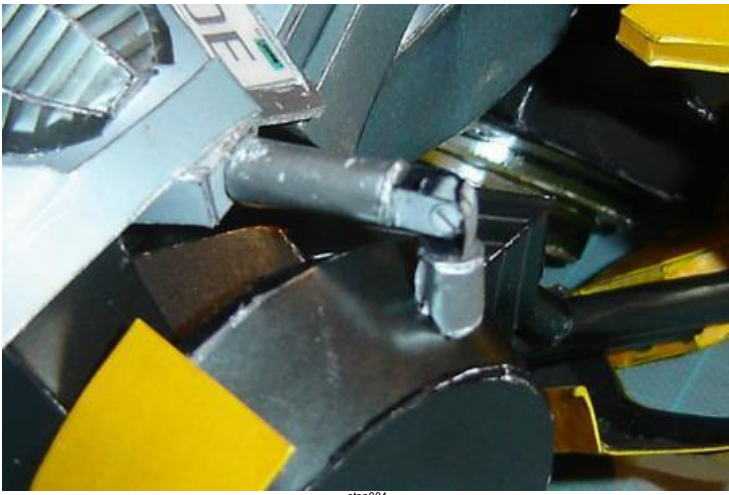

step084

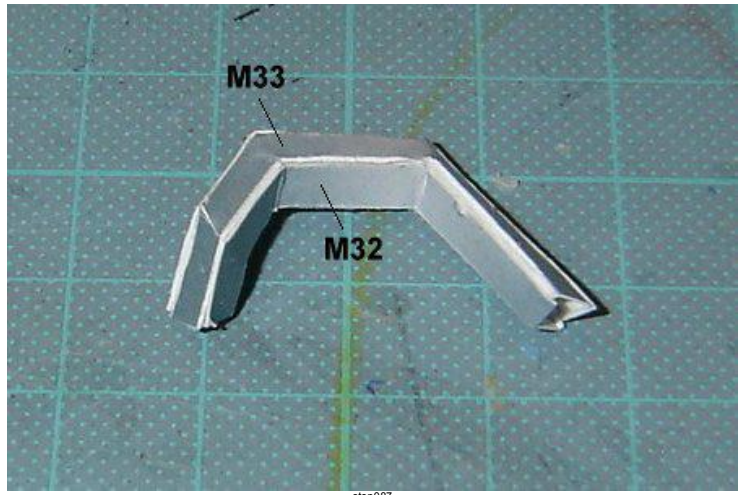

step087



step084a

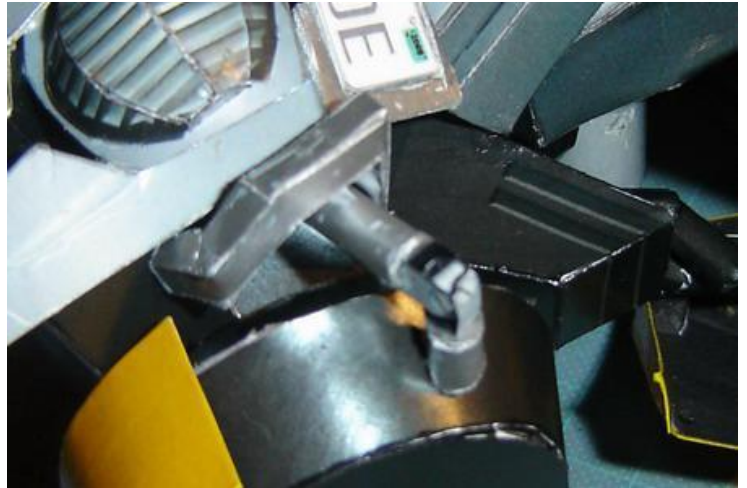

step088

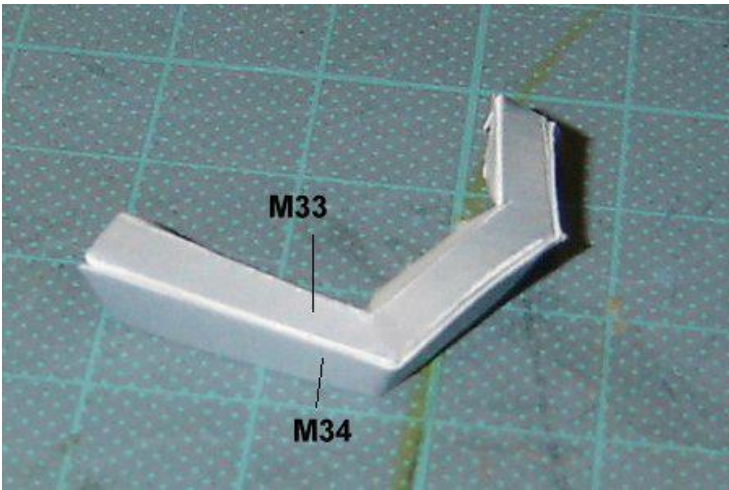

step085



step088a

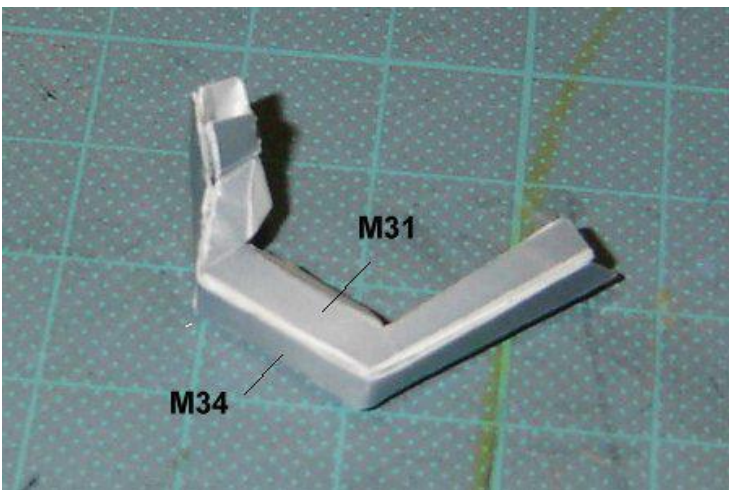

step086

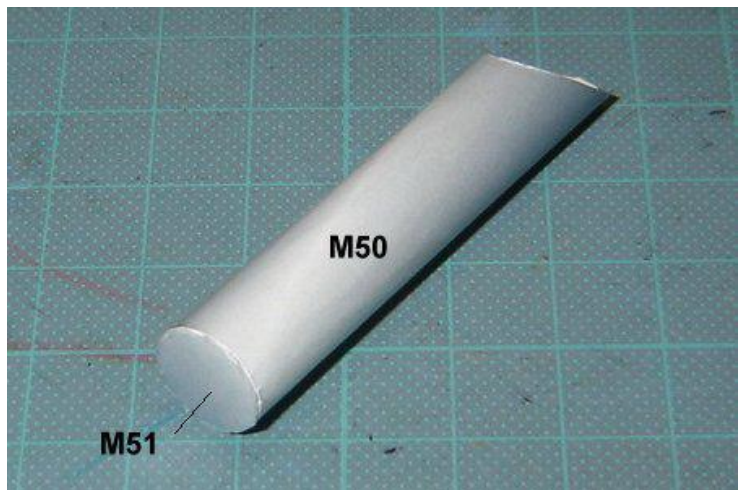

step089

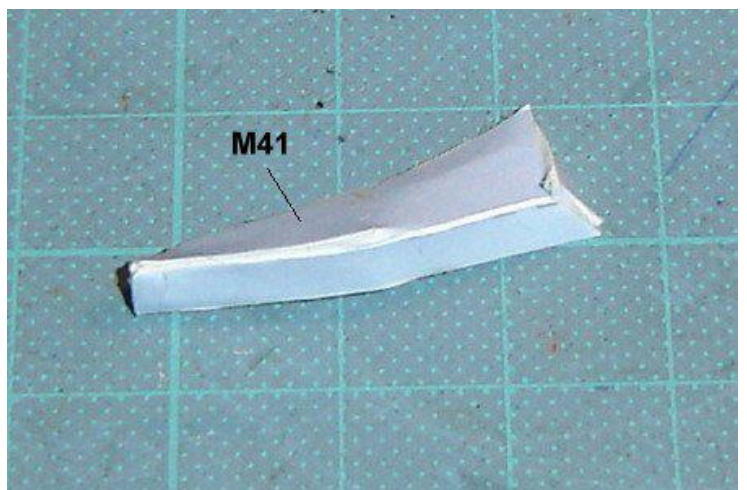
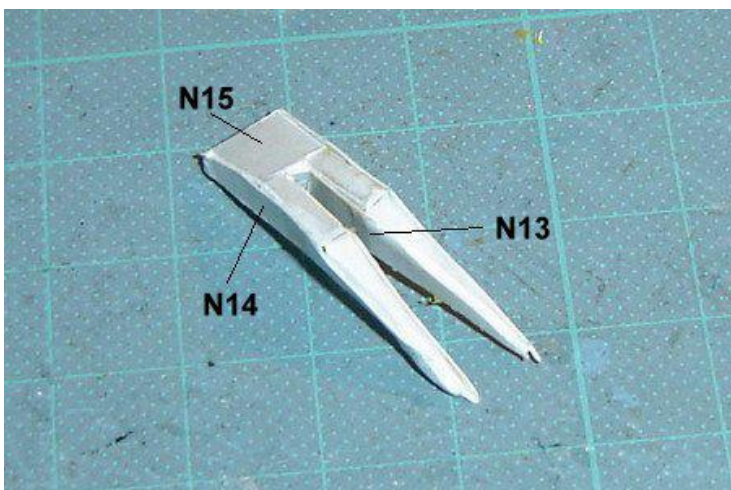
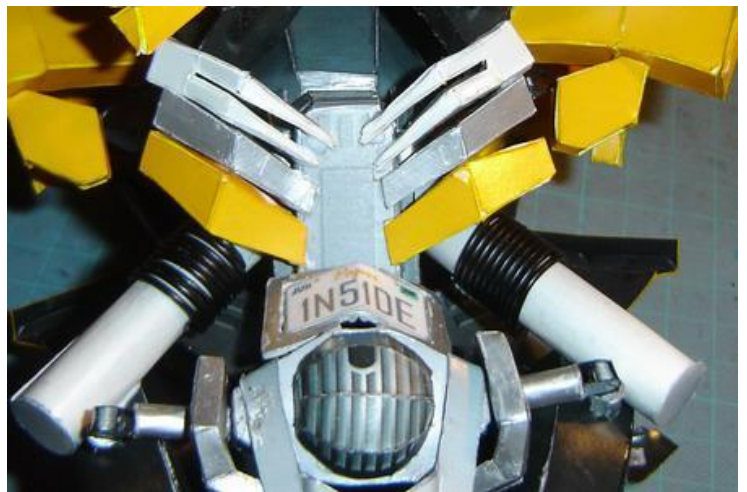
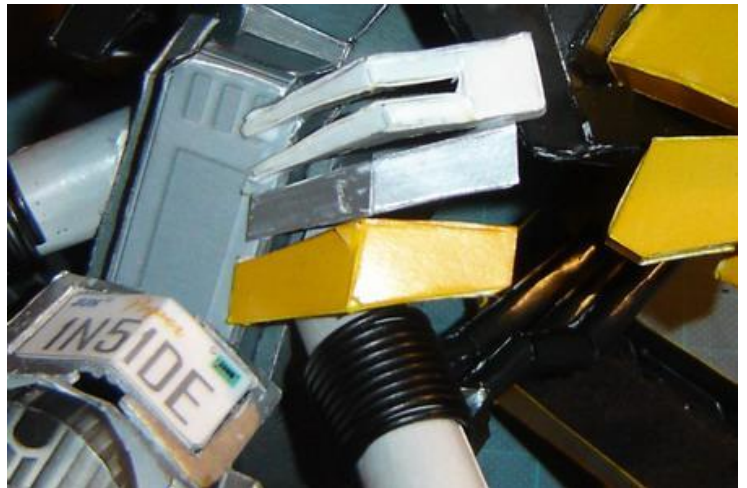
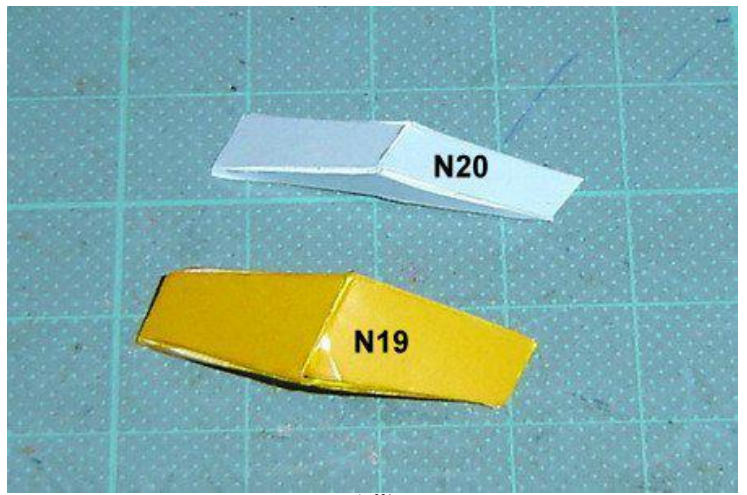

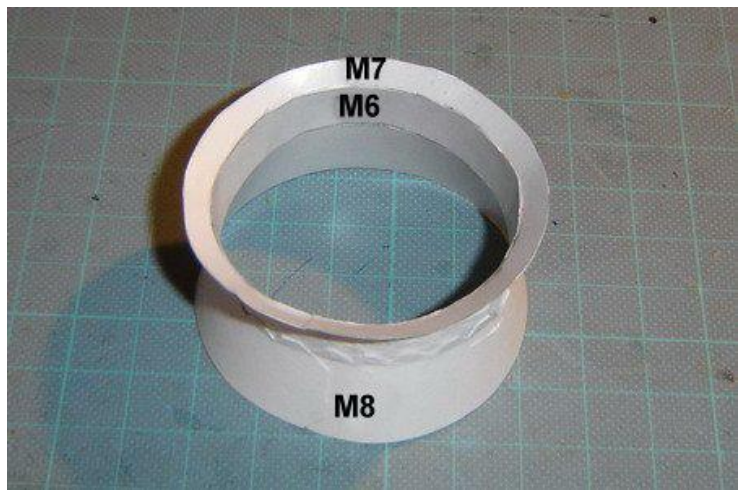
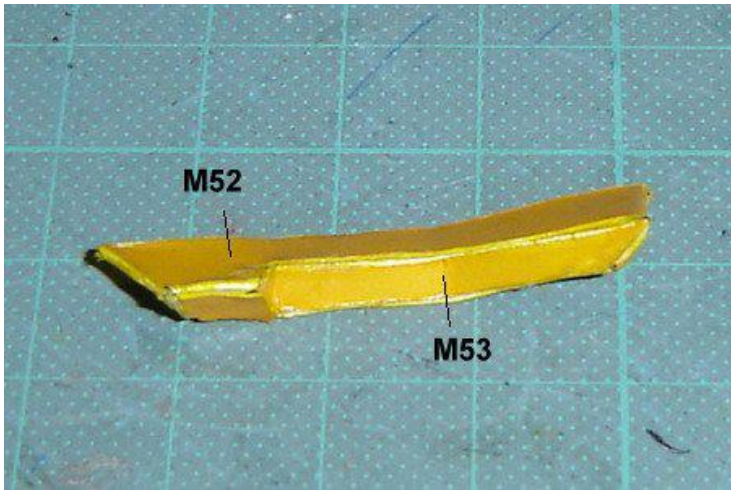
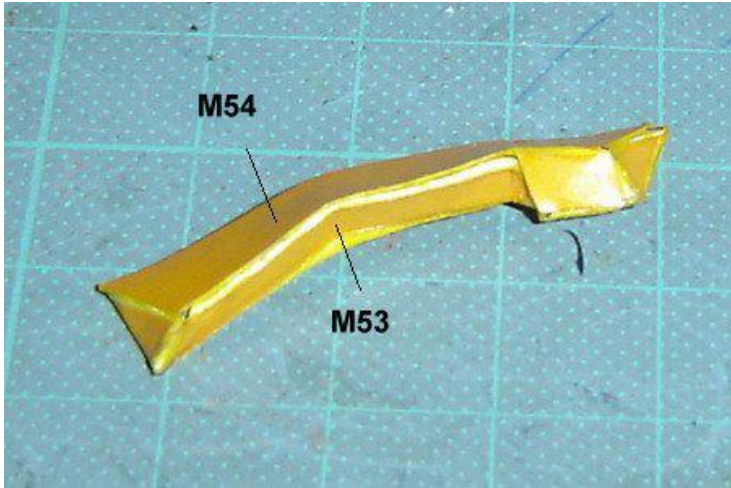
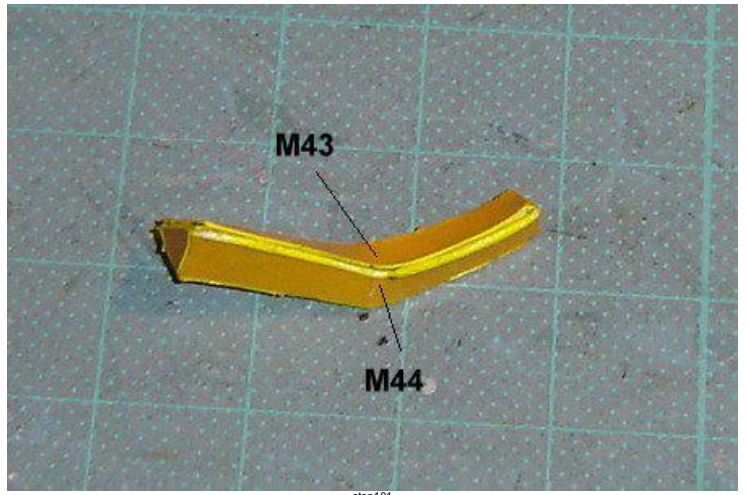
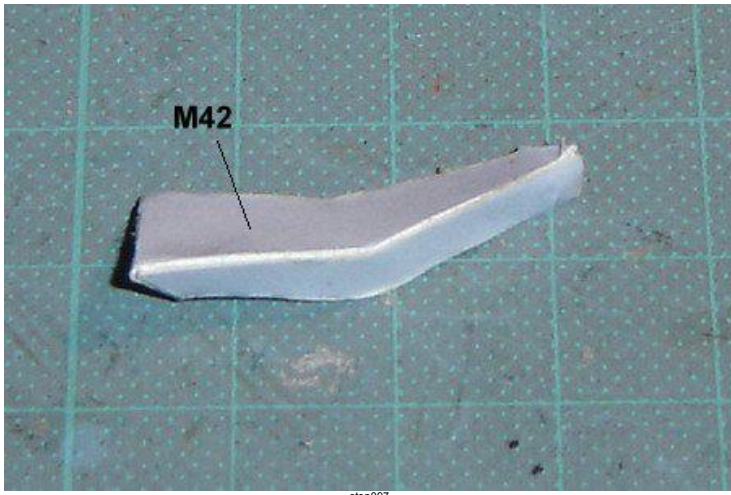

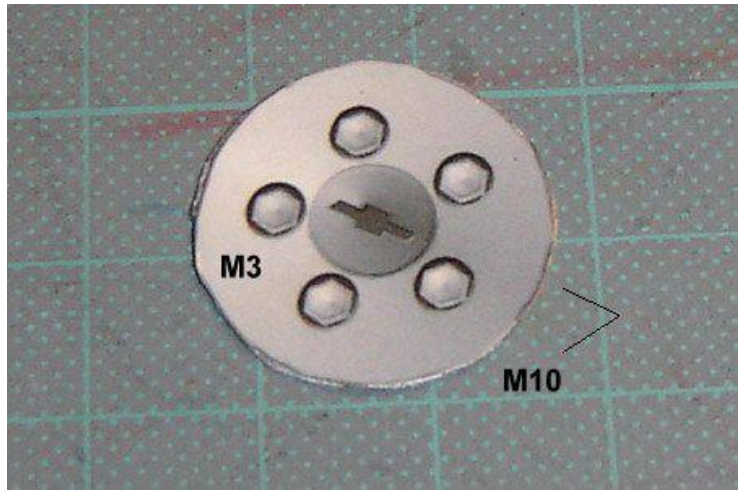
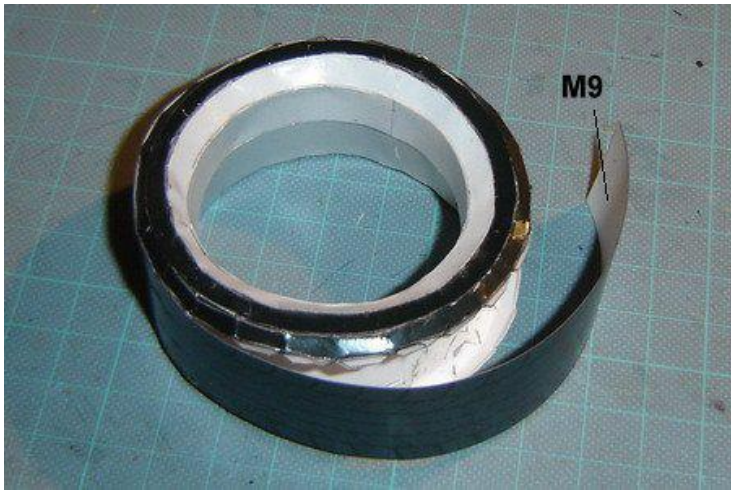
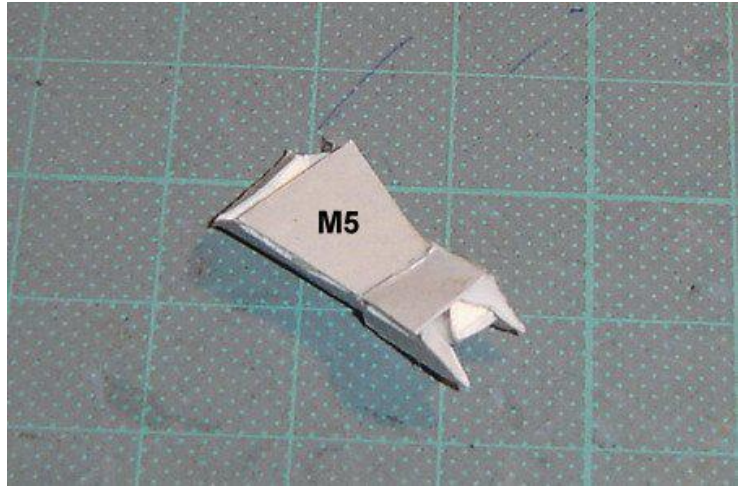
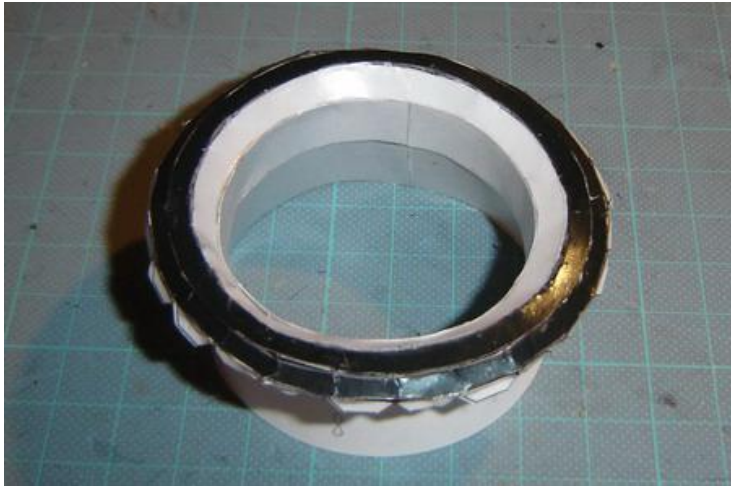
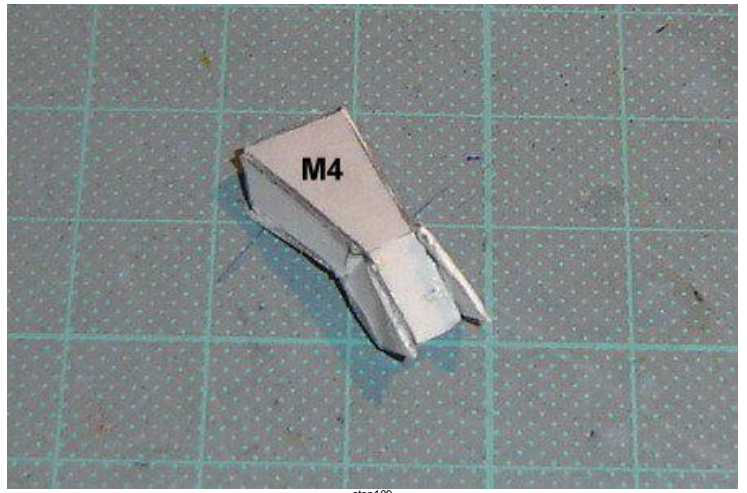



step112

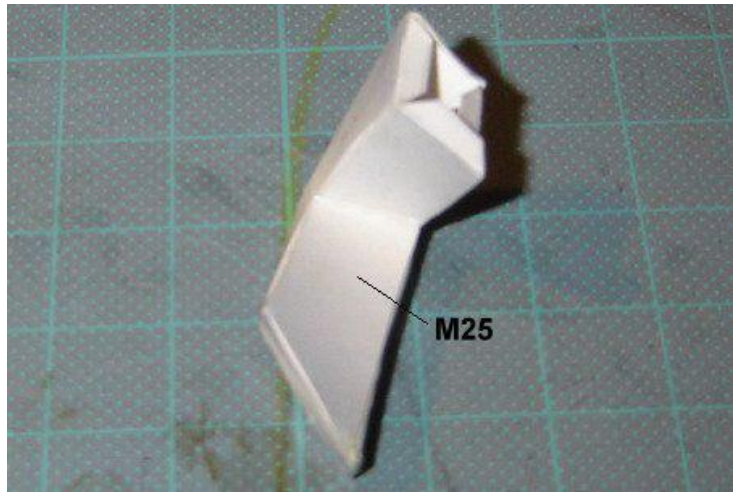

step116



step113

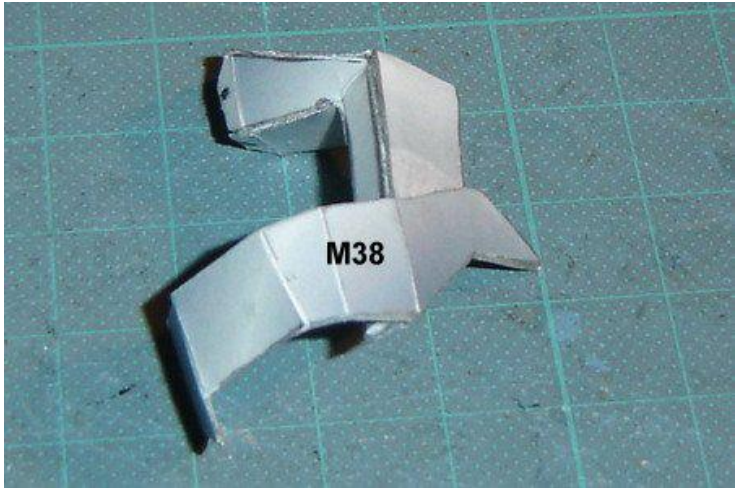

step117

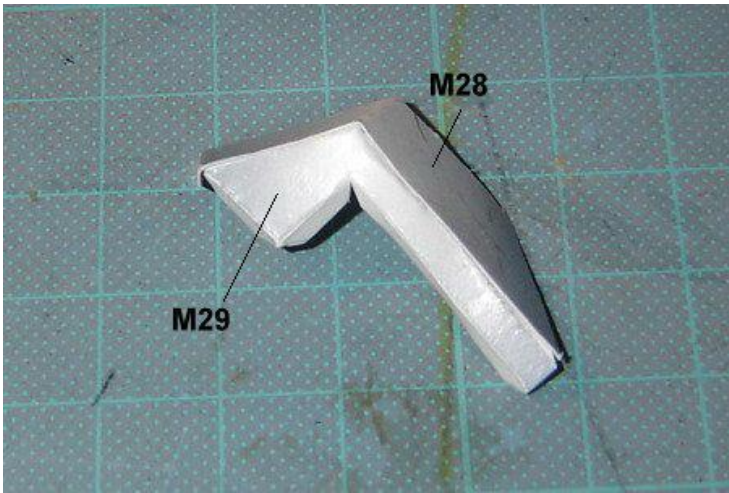

step114

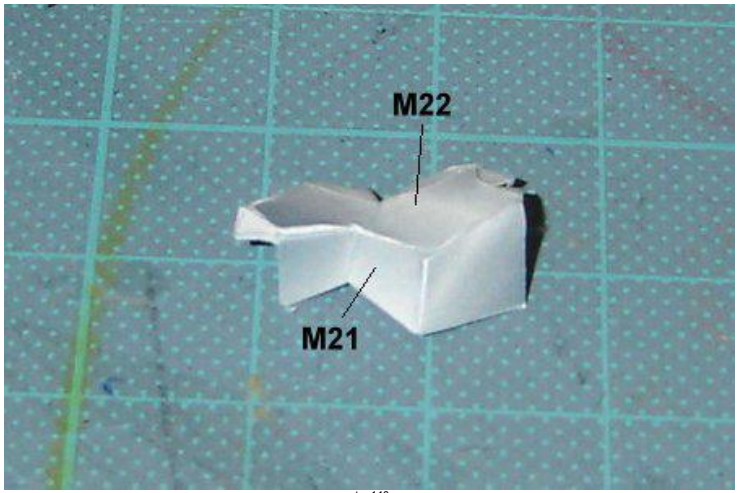

step118



step115

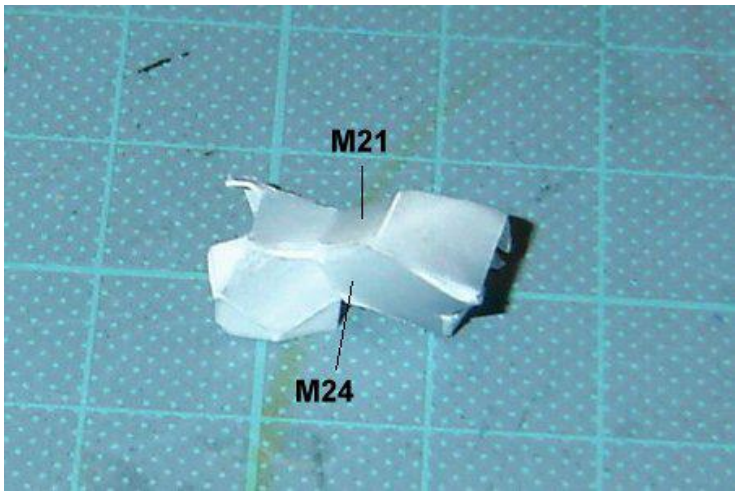

step119

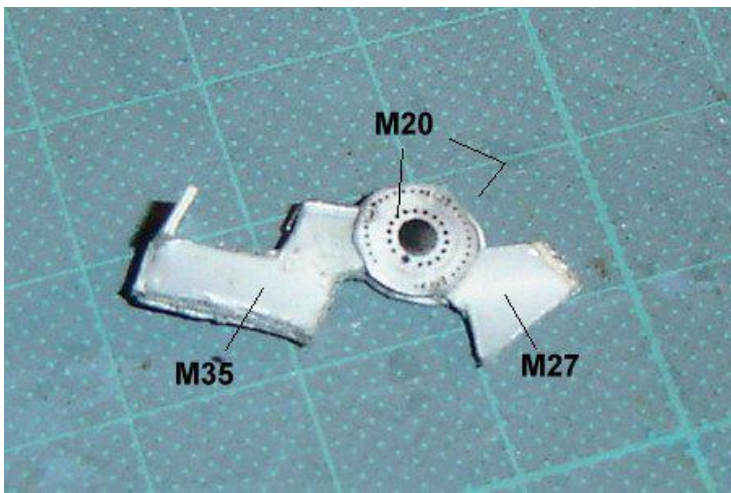
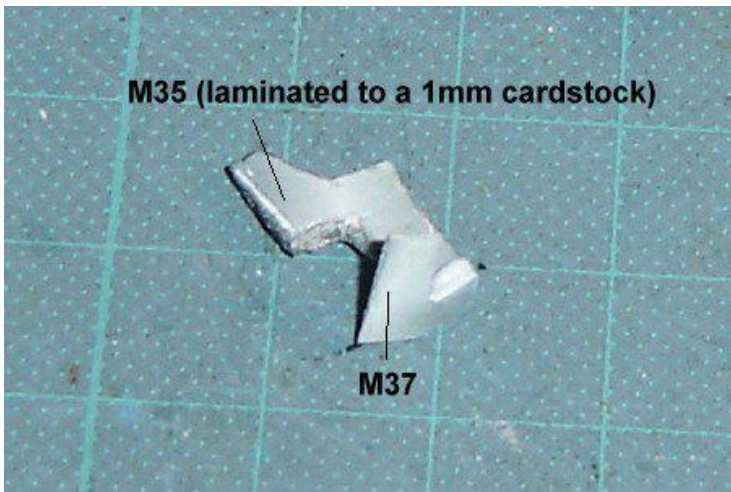
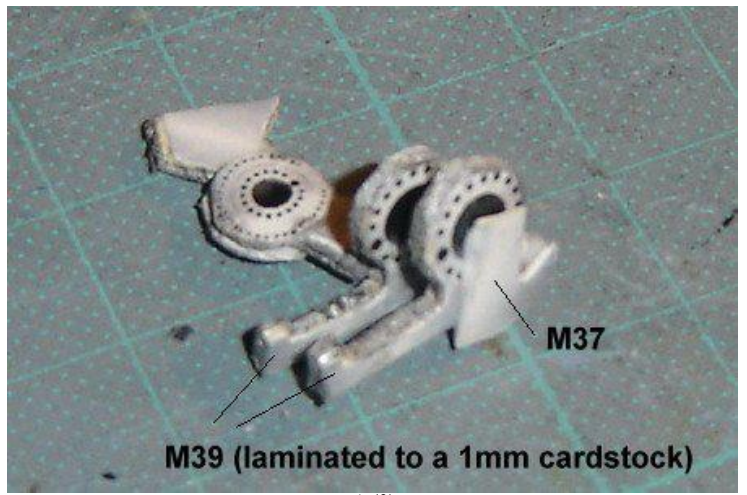
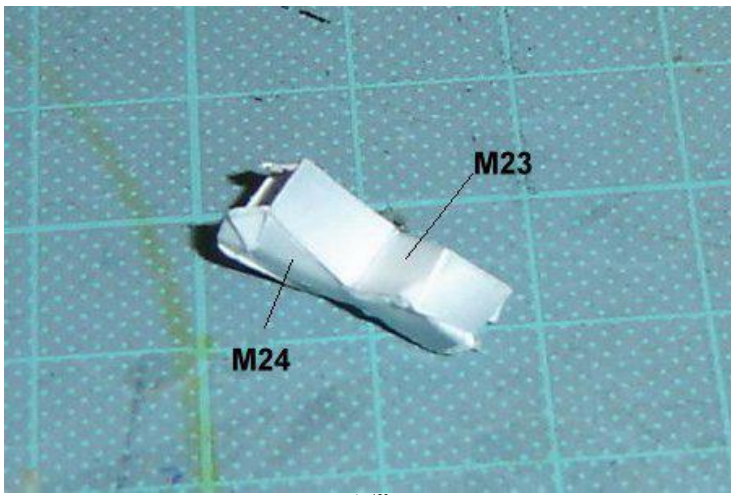



step126



step130a



step128a

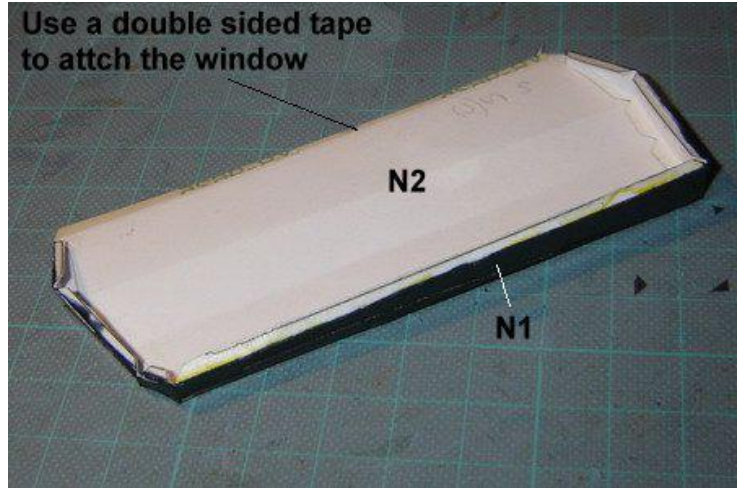

step131



step129

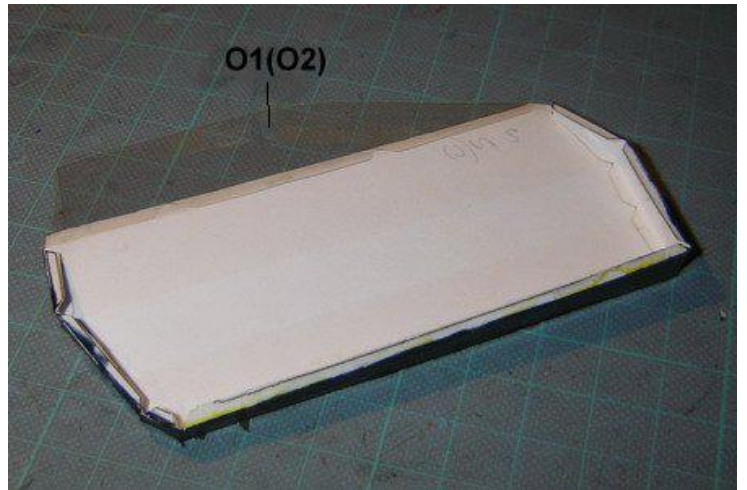

step132



step130

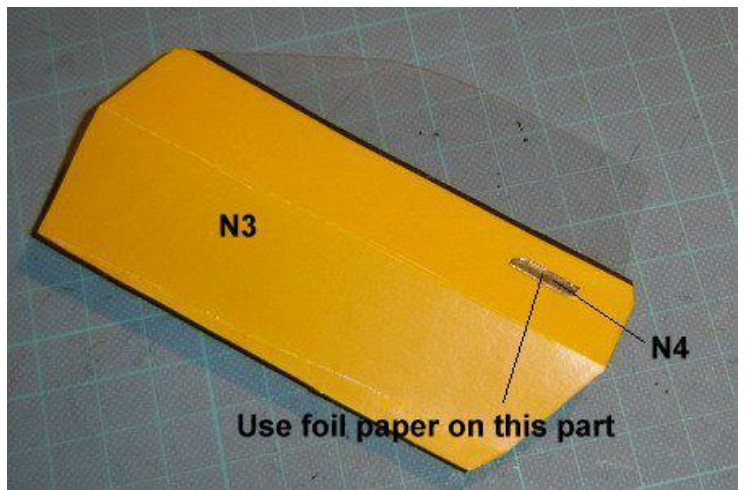

step133

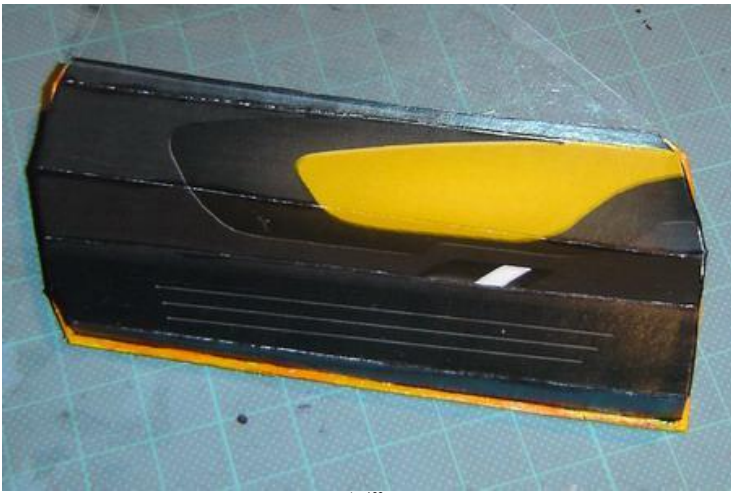

step133a

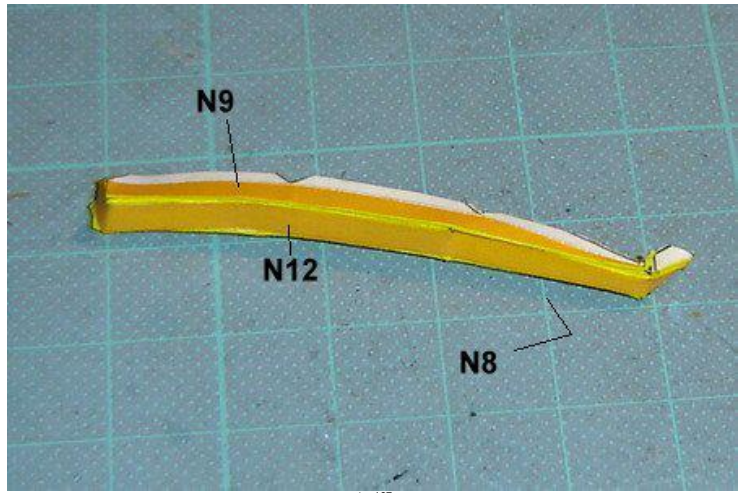

step137

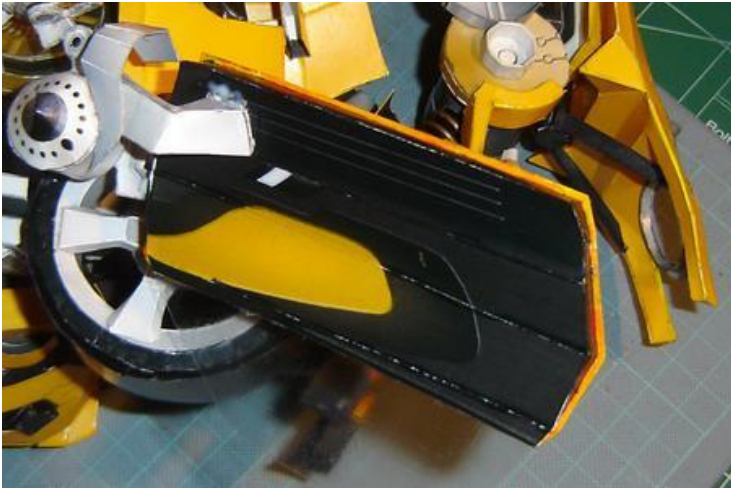

step134

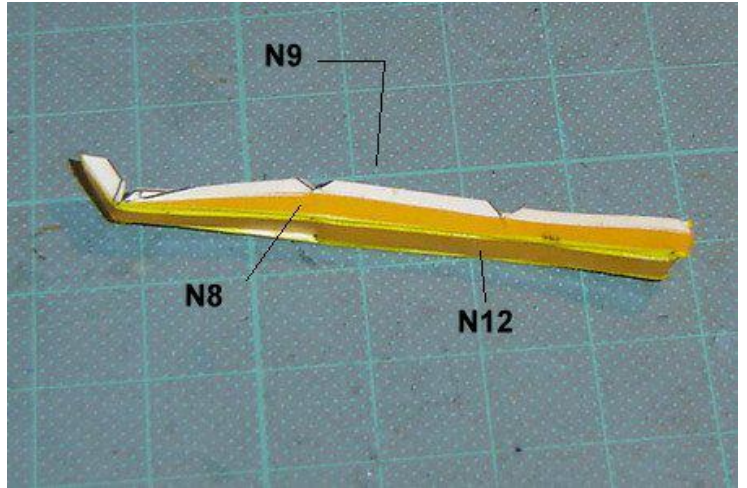

step138

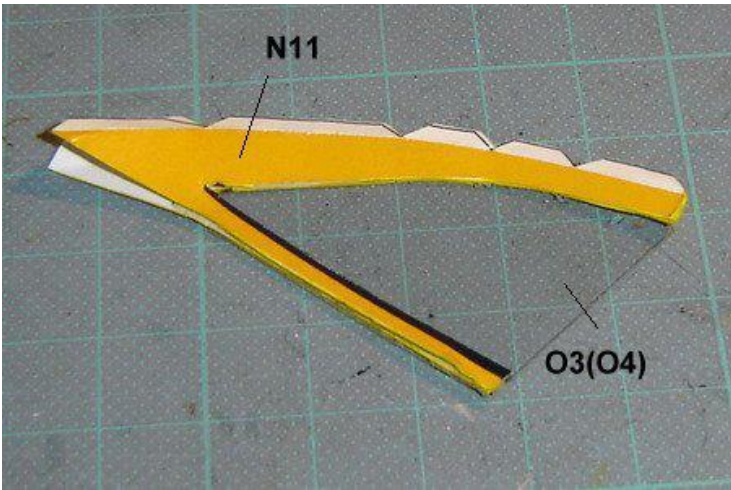

step135

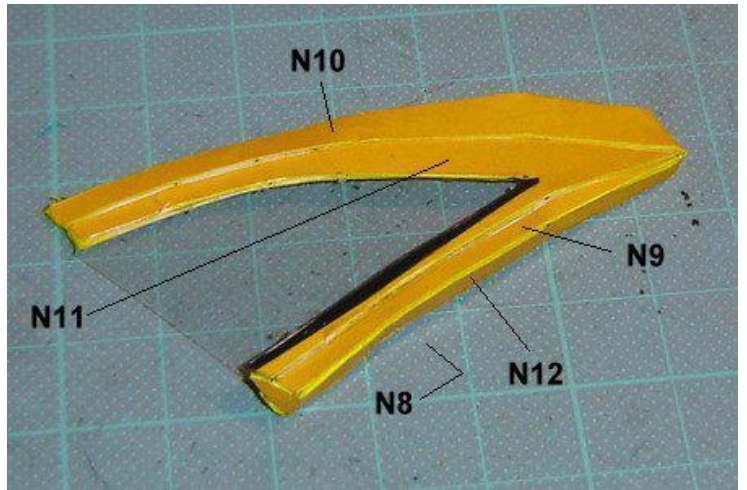

step139

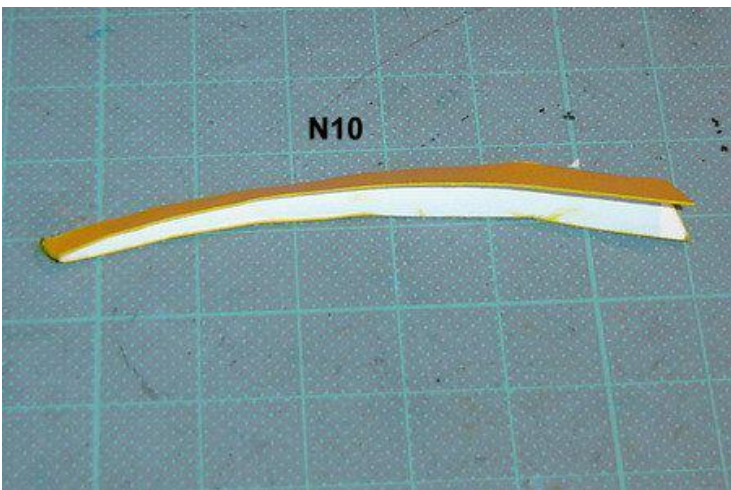

step136



step140



step140a



step144

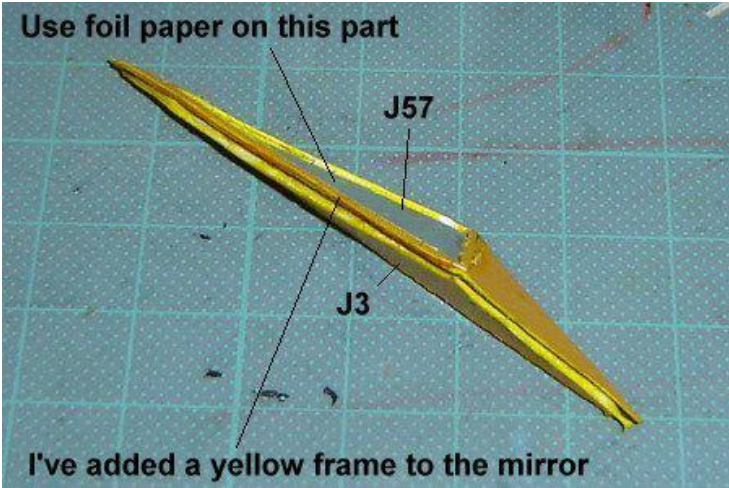

Use foil paper on this part

J57

J3

I've added a yellow frame to the mirror

step141



Join the arms

step145



J55

Laminate part J55 on a black cardstock

step142



step145a

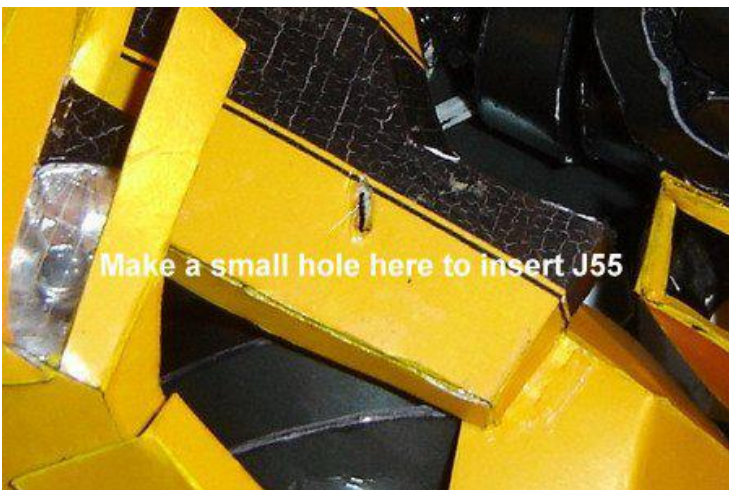

Make a small hole here to insert J55

step143



Join the legs

step146



step146a

Thank you for download Bumblebee Torso!



step147