

THESE INSTRUCTIONS SHOW  
PICTURES OF THE LEFT LEG

IN ORDER TO BUILD THE RIGHT LEG,  
CONSIDER ALL PICTURES AS  
MIRRORED

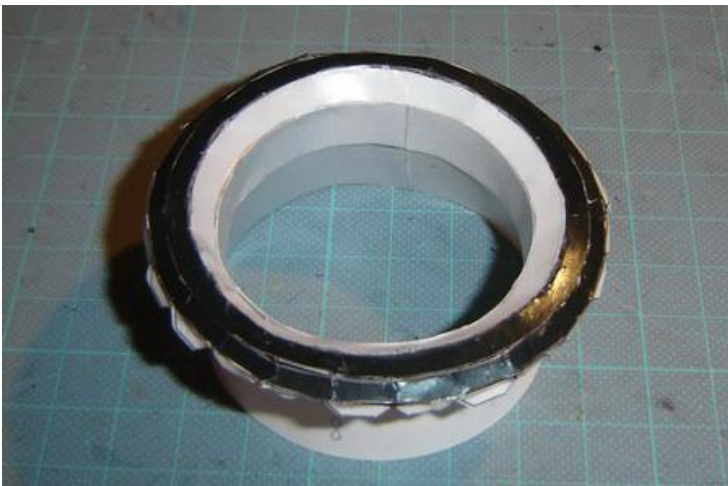

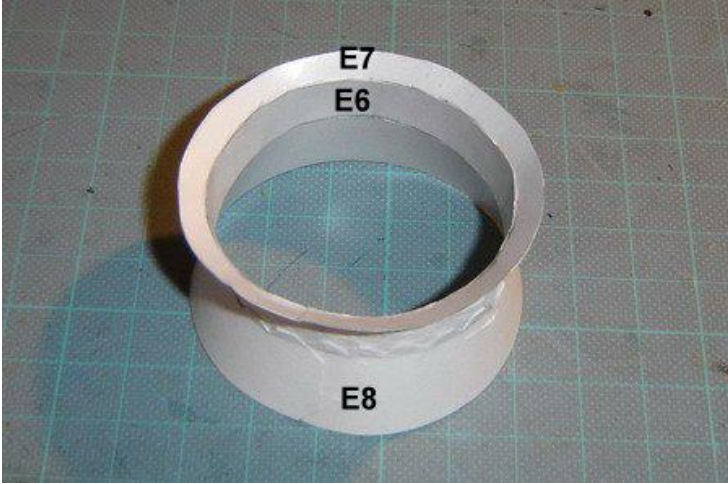
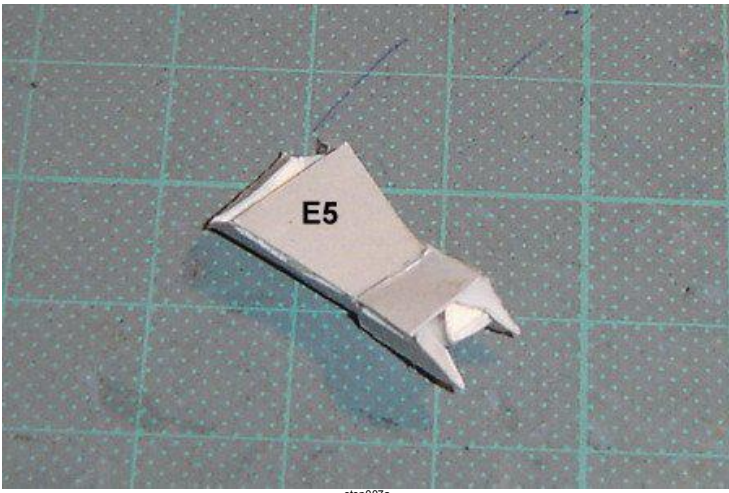

step007a



step011

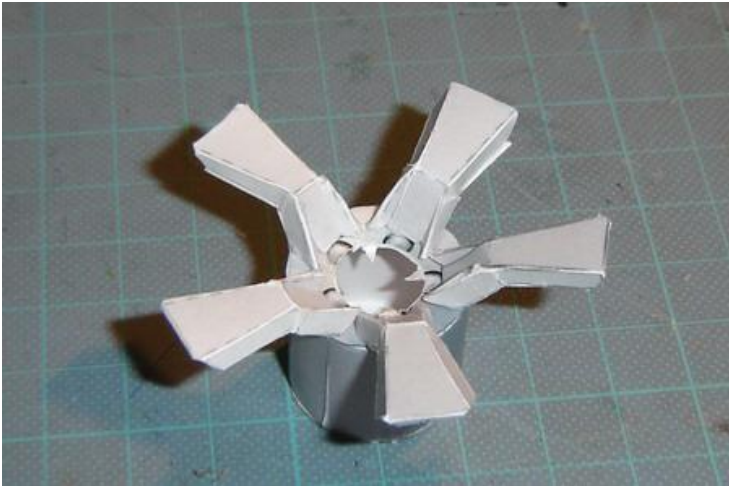

step008

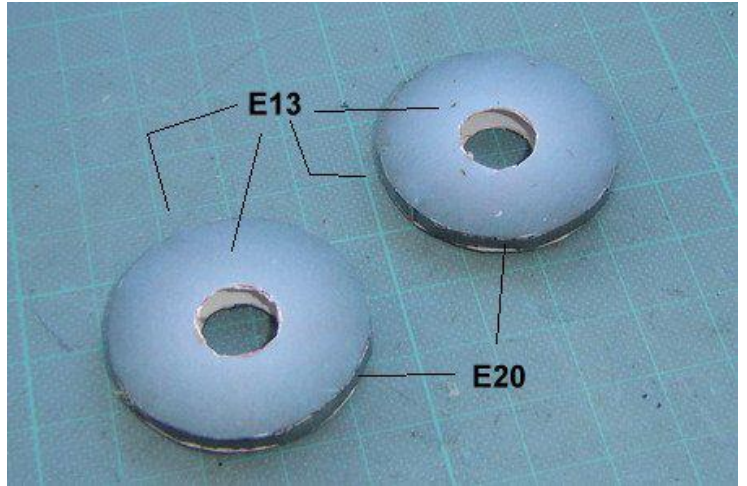

step012



step009

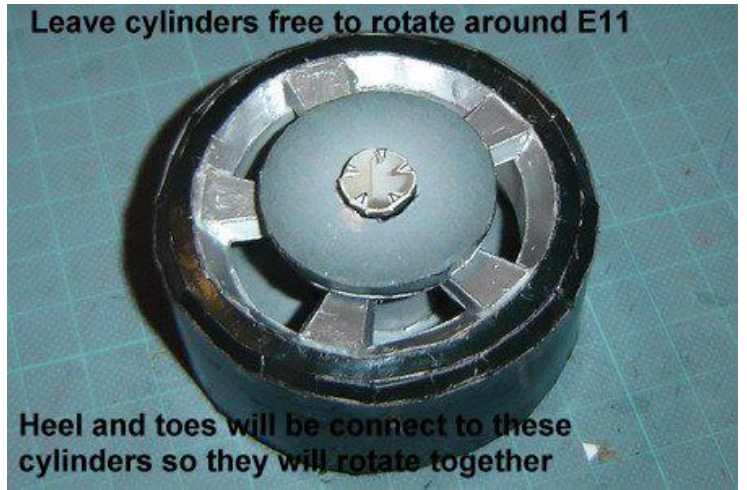

step013

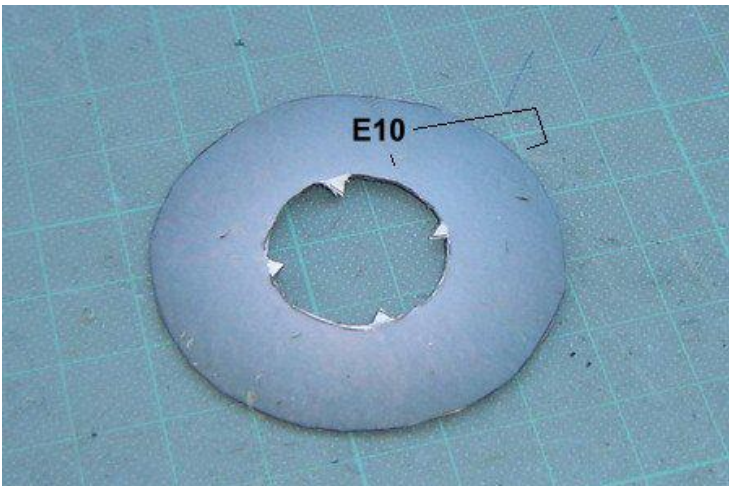

step010



step014

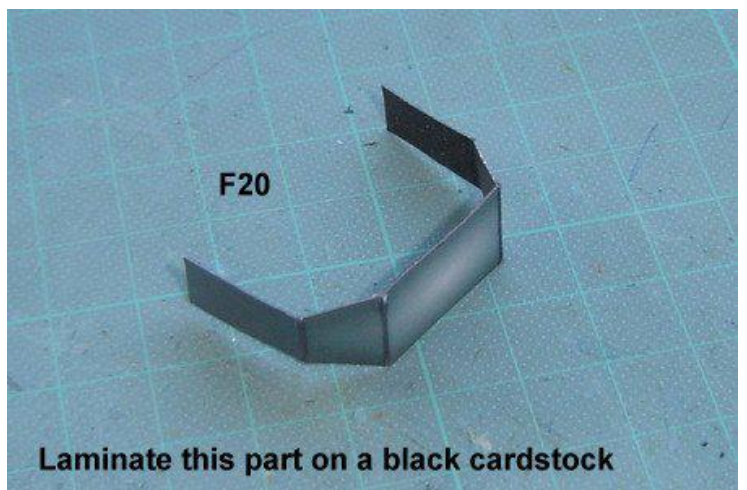
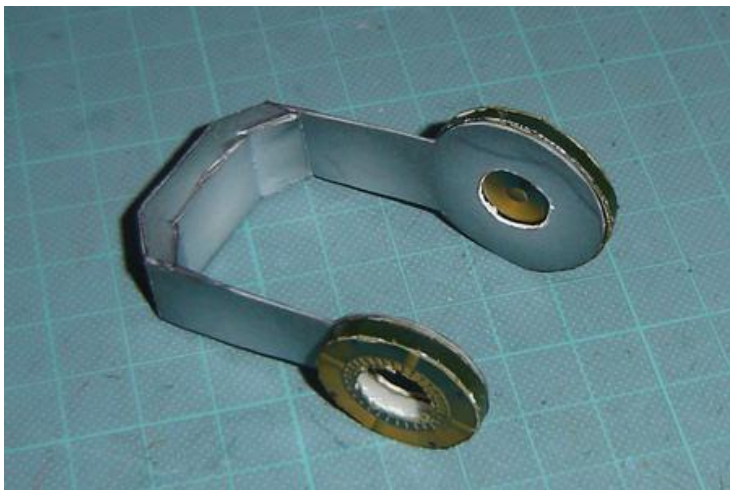
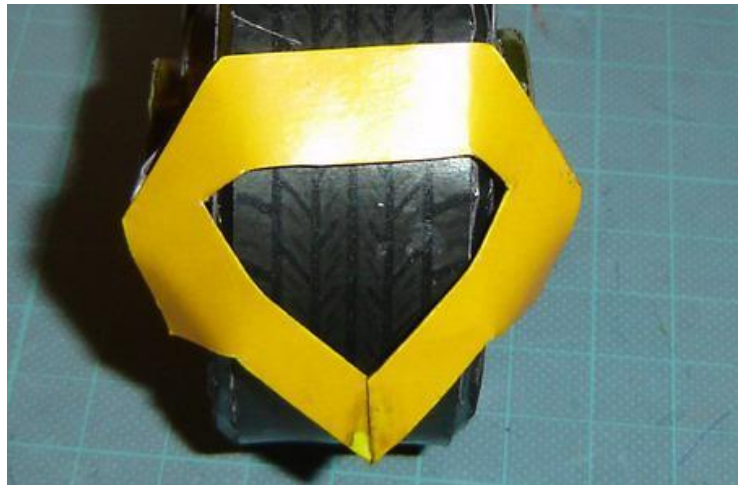
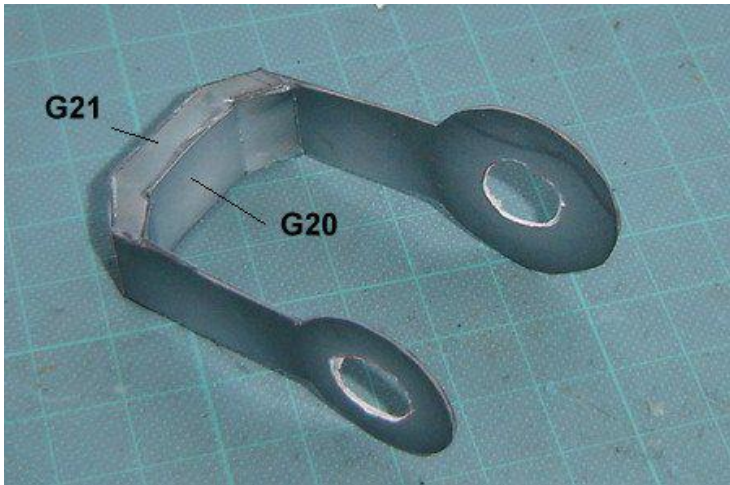
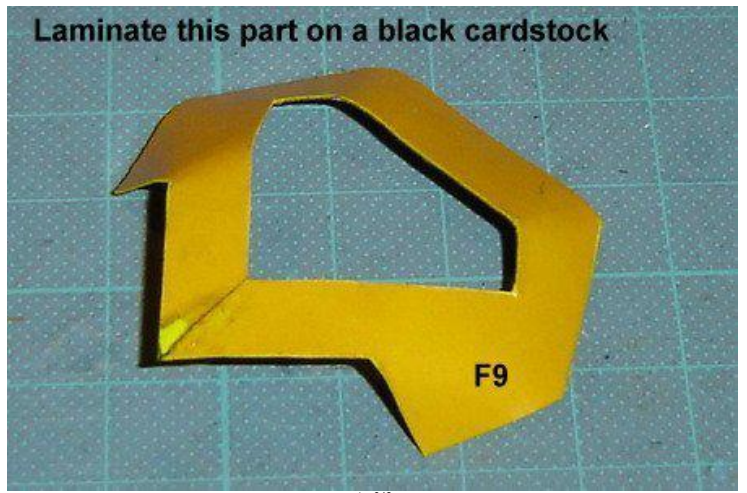
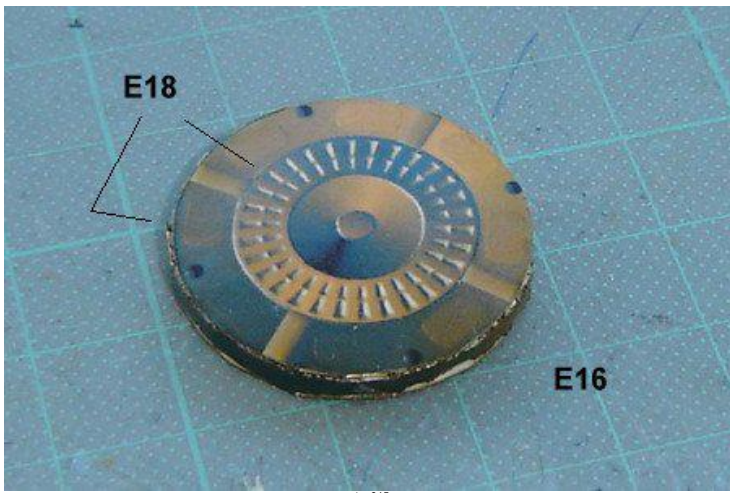

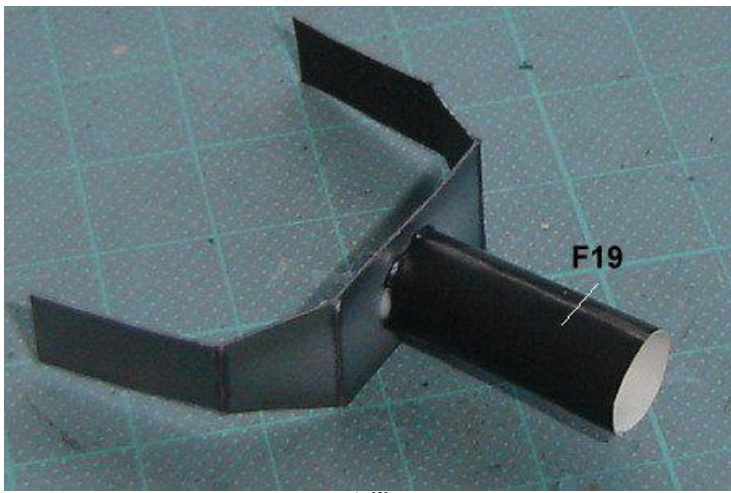

step023



step027



step024



step028



step025

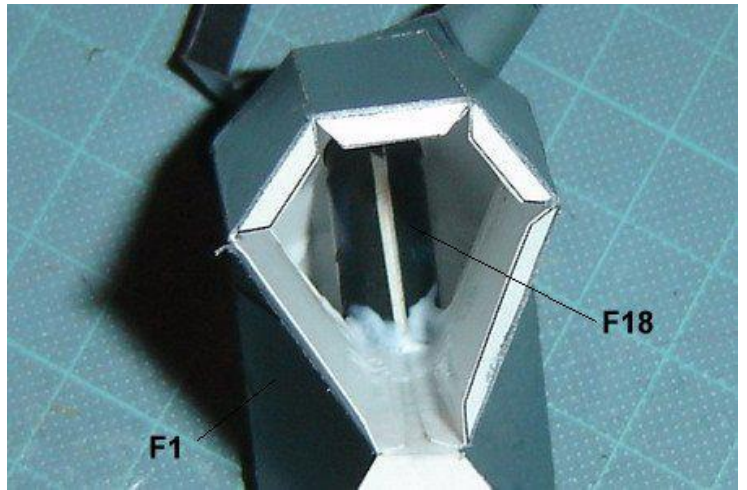

step029

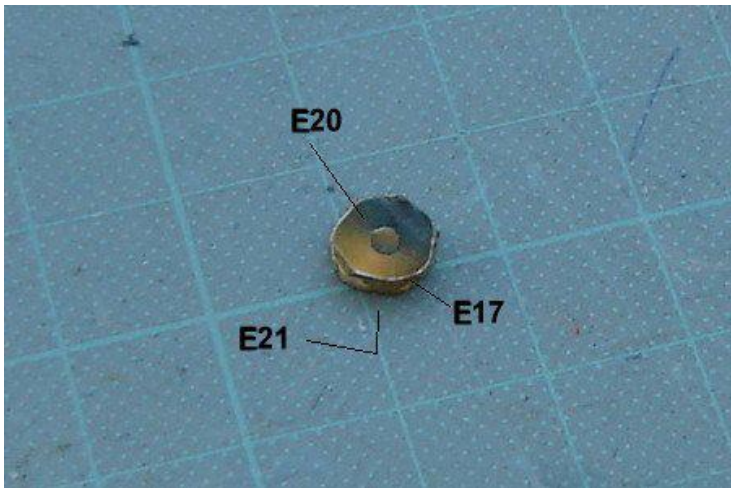

step026

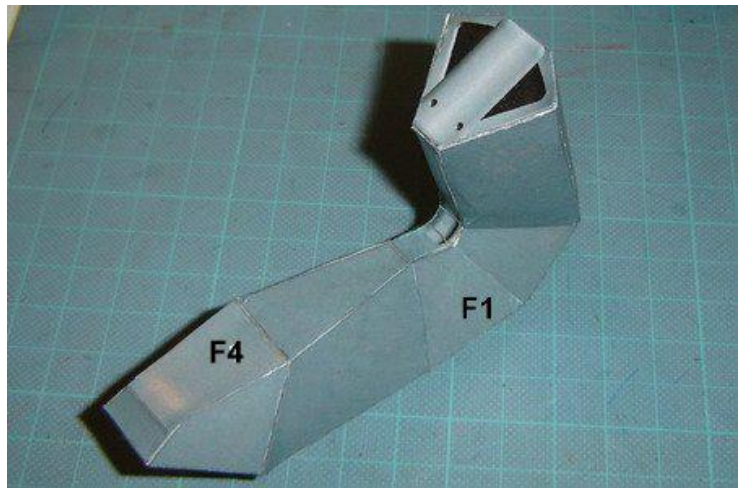

step030

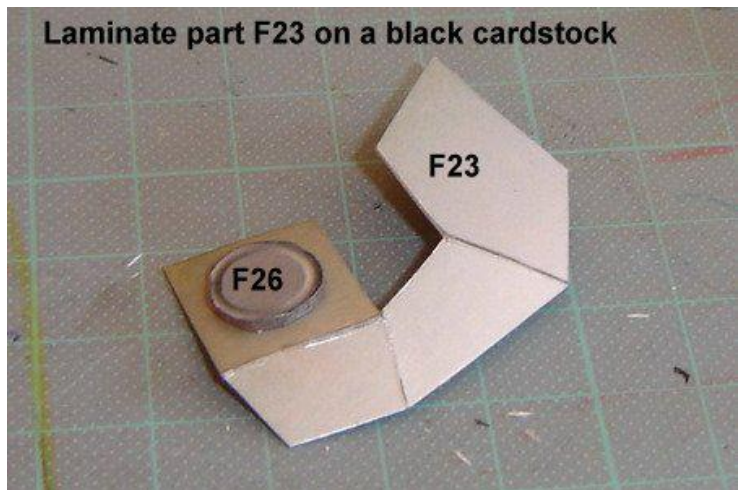
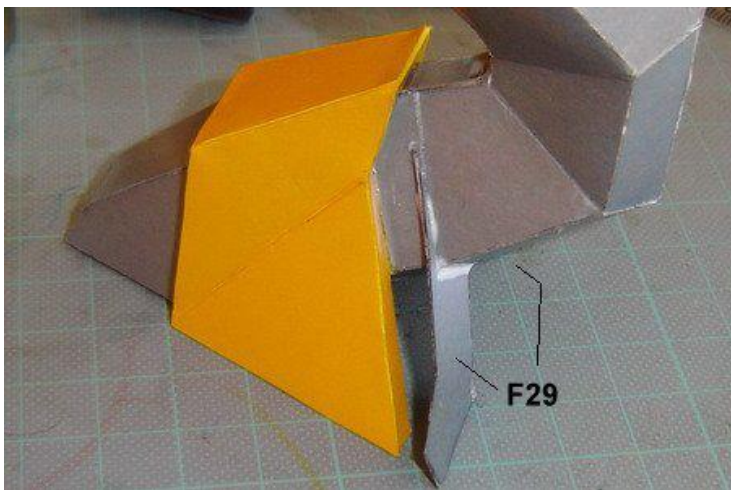
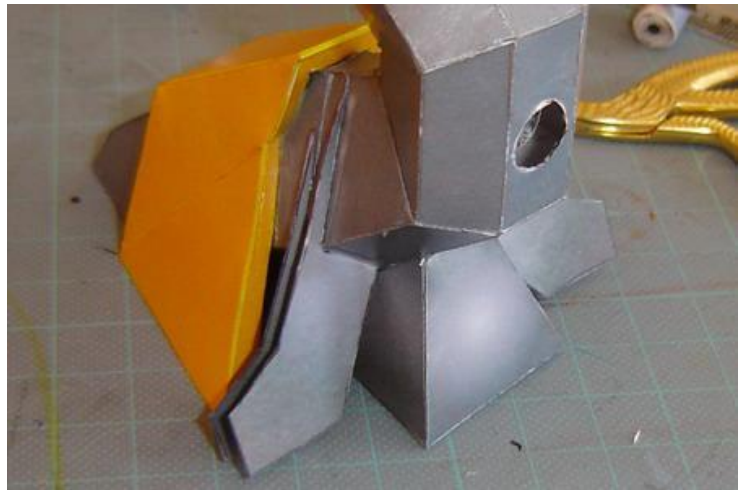
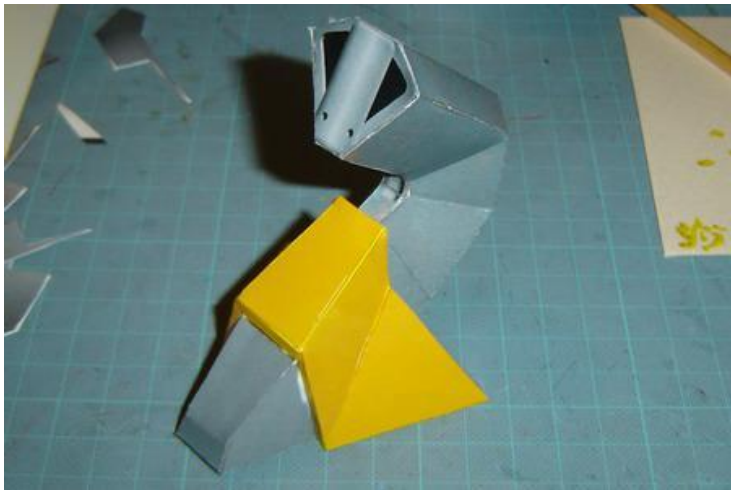
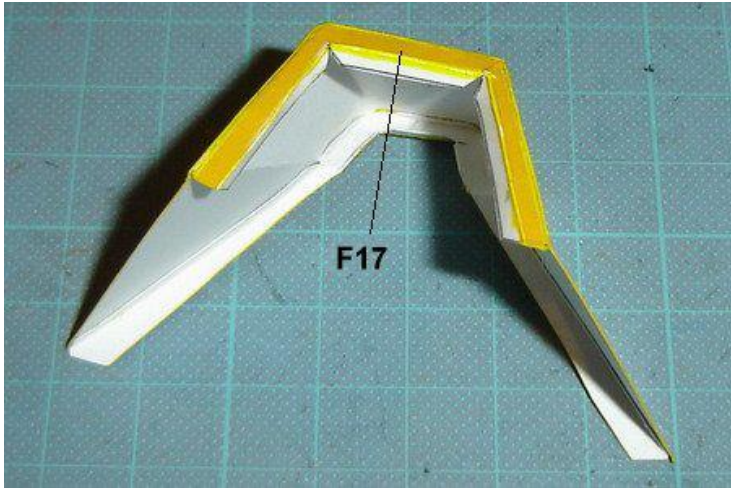
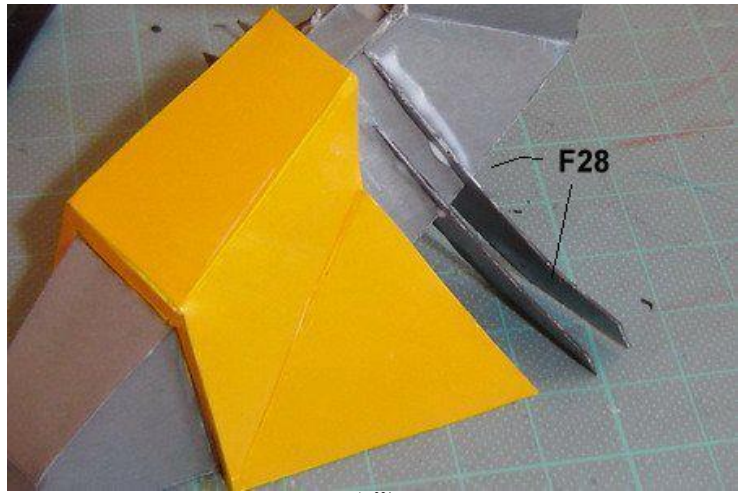
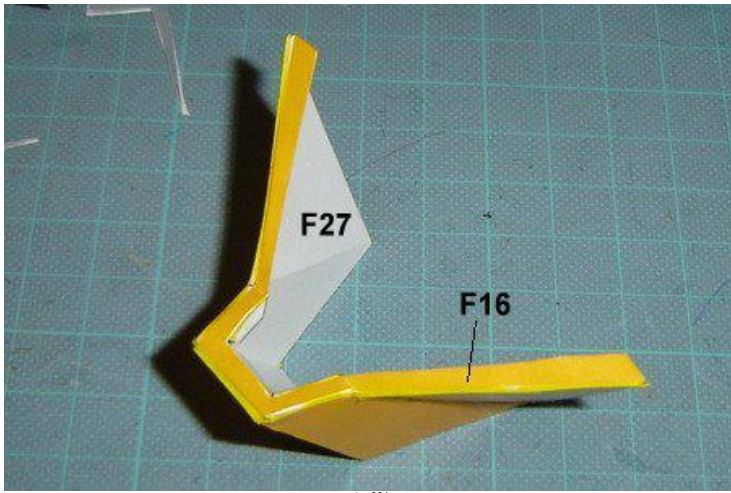

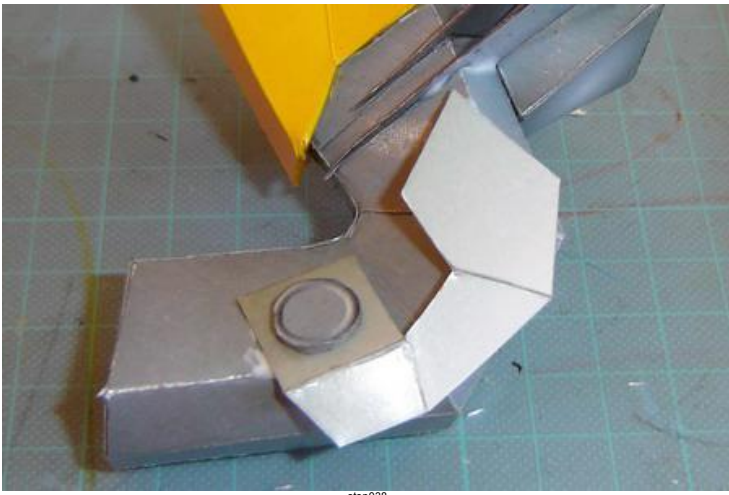

step038

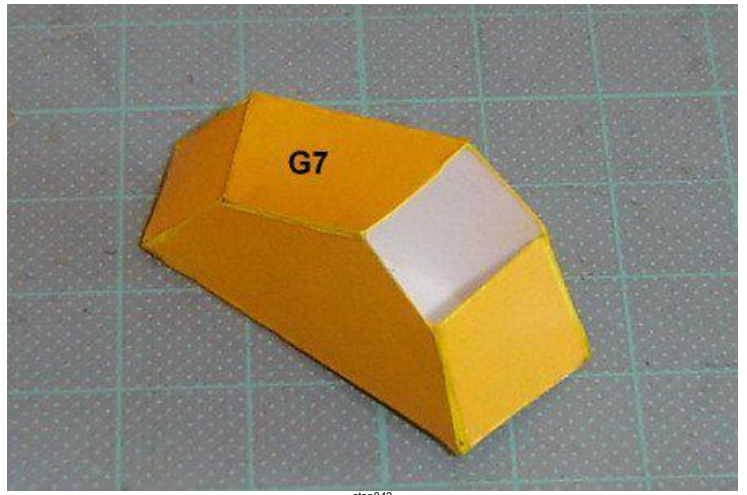

step042

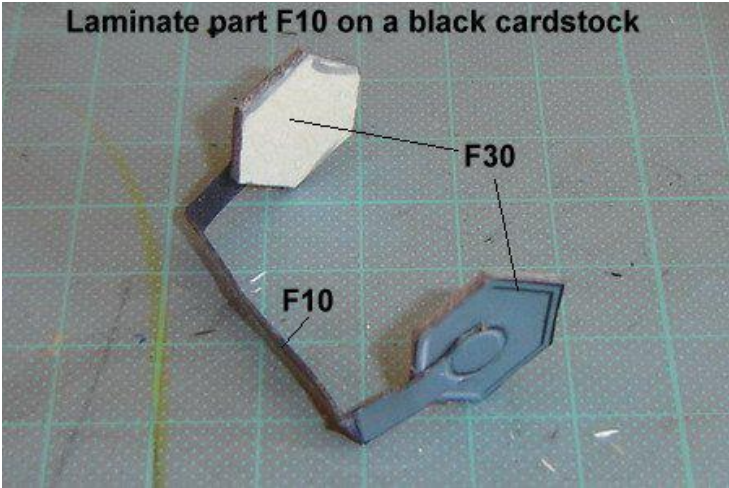

Laminate part F10 on a black cardstock

step039

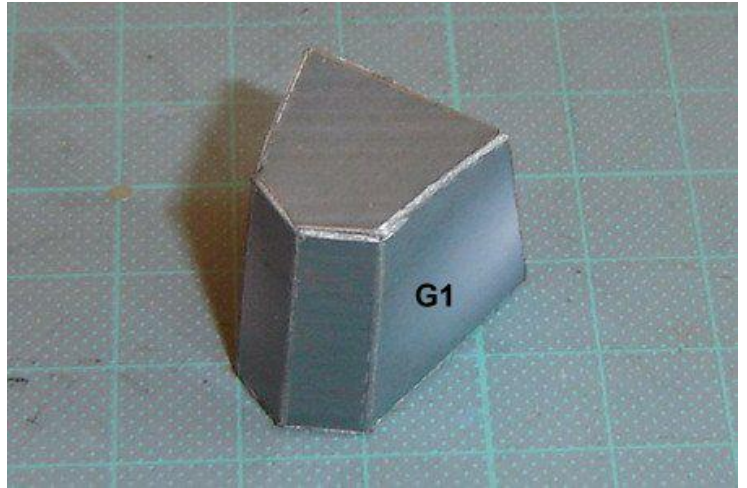

step043

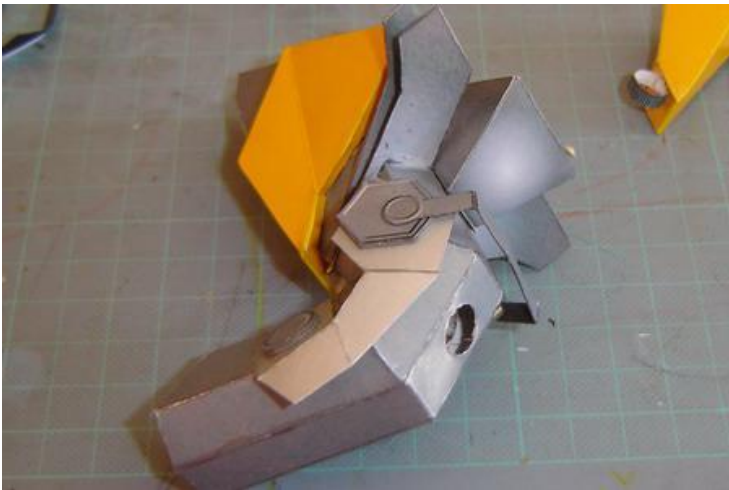

step040

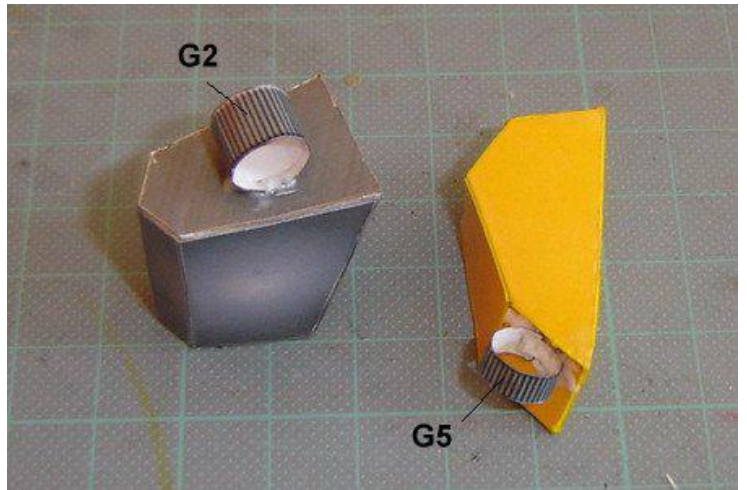

step044

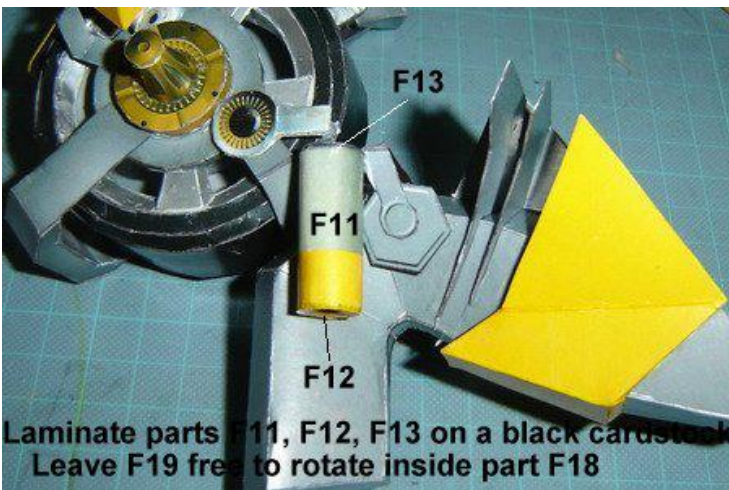

Laminate parts F11, F12, F13 on a black cardstock  
Leave F19 free to rotate inside part F18

step041

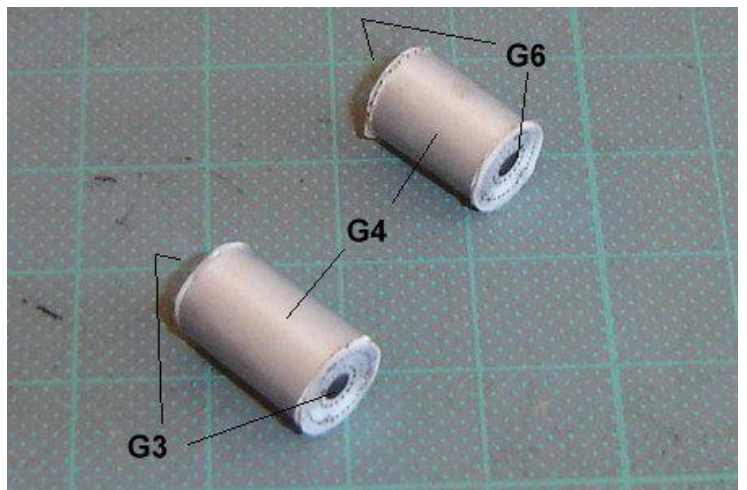

step045

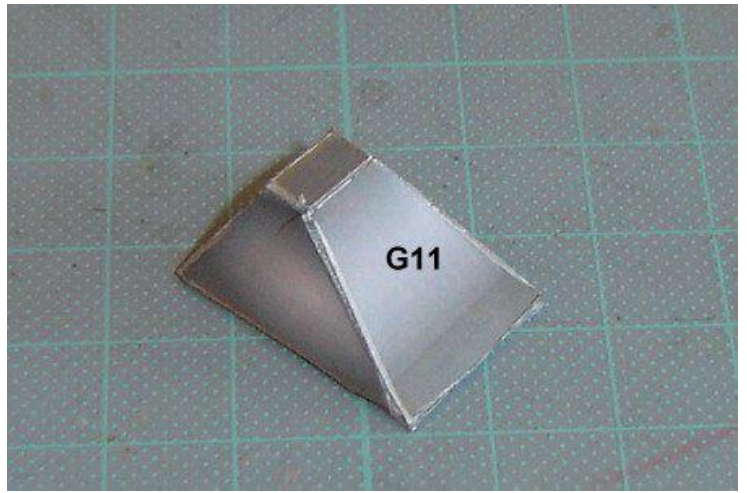
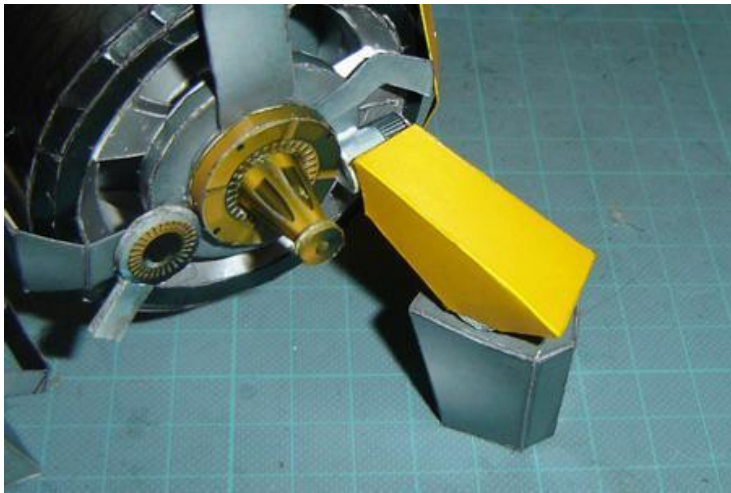
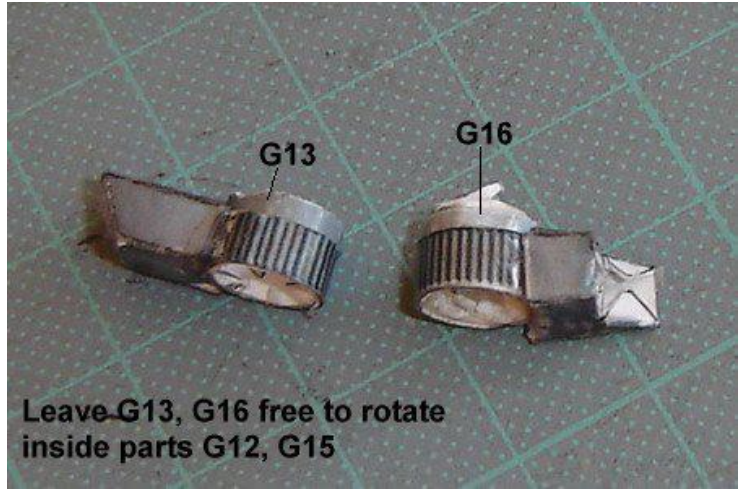
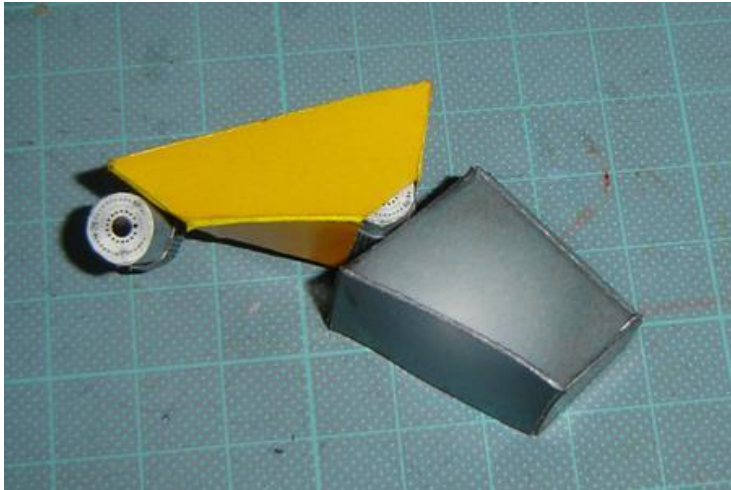
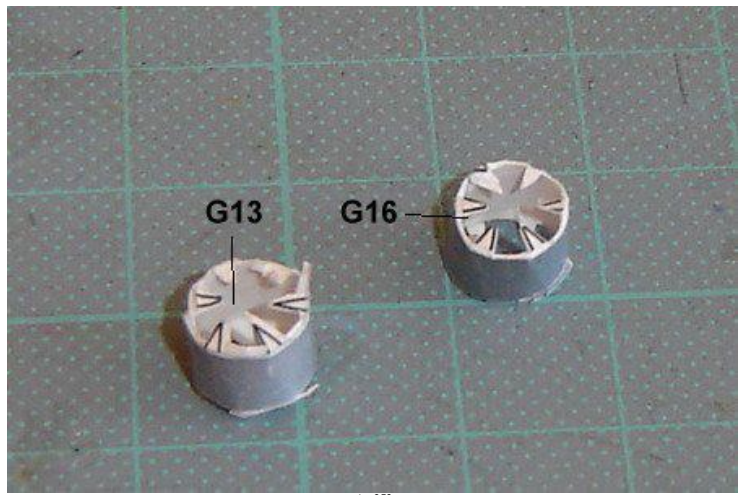

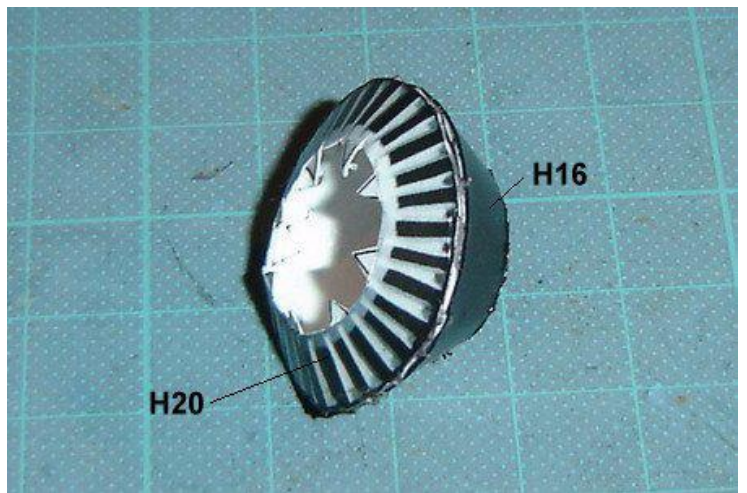
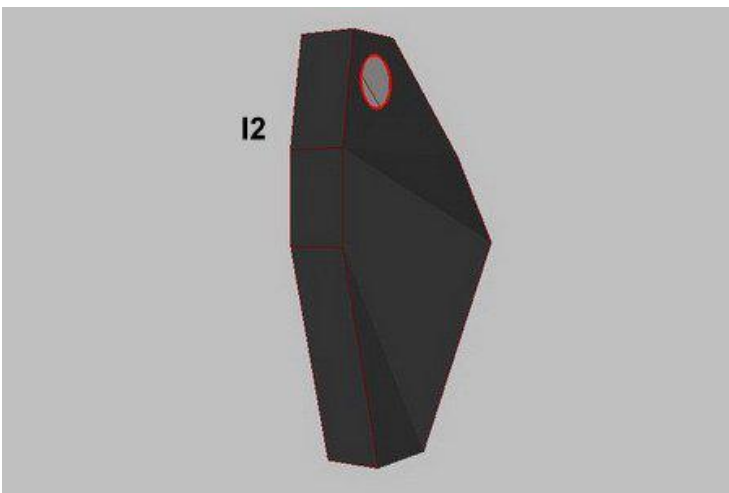
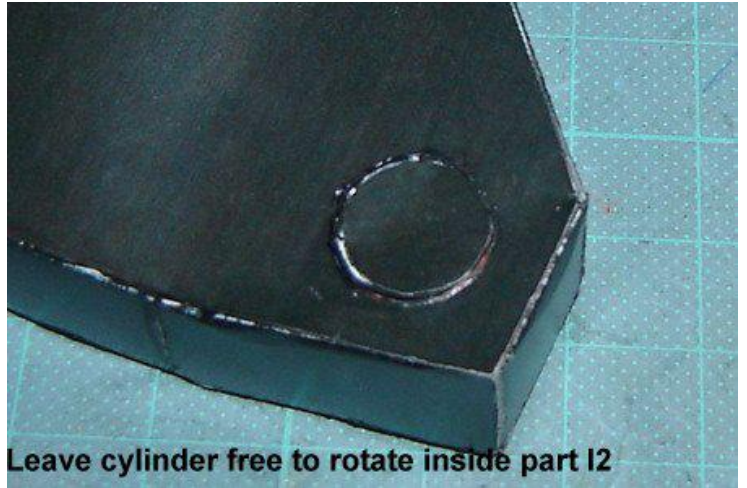
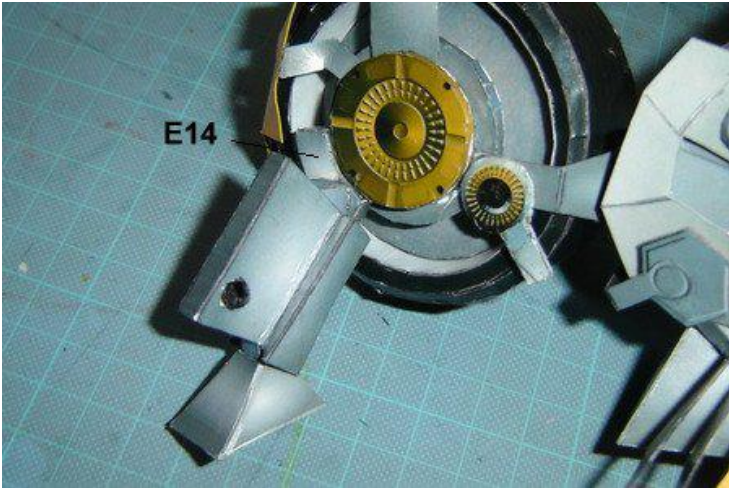
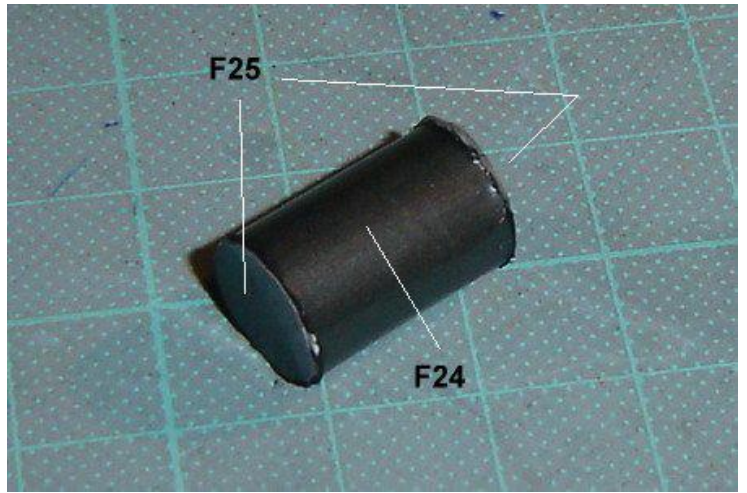
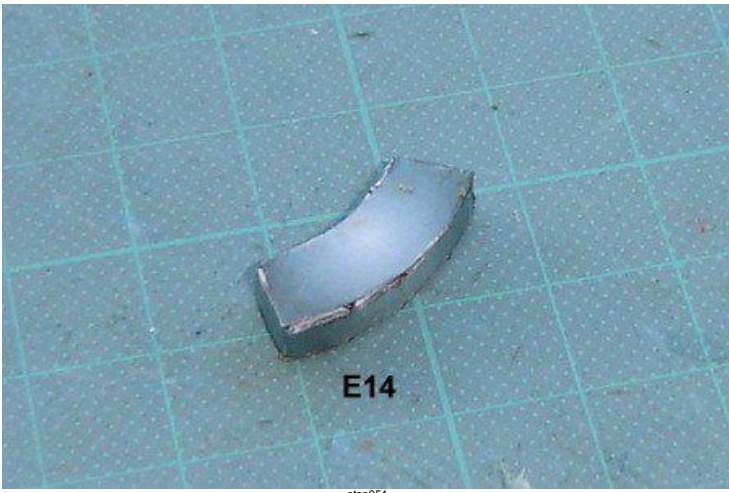





step062

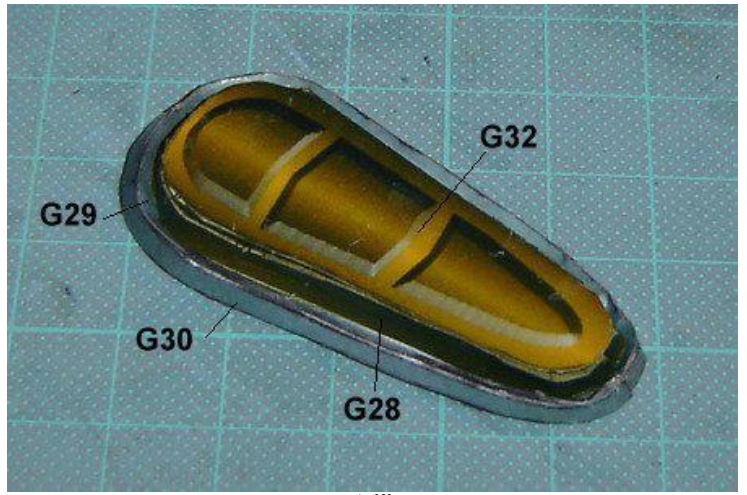

step066



step063

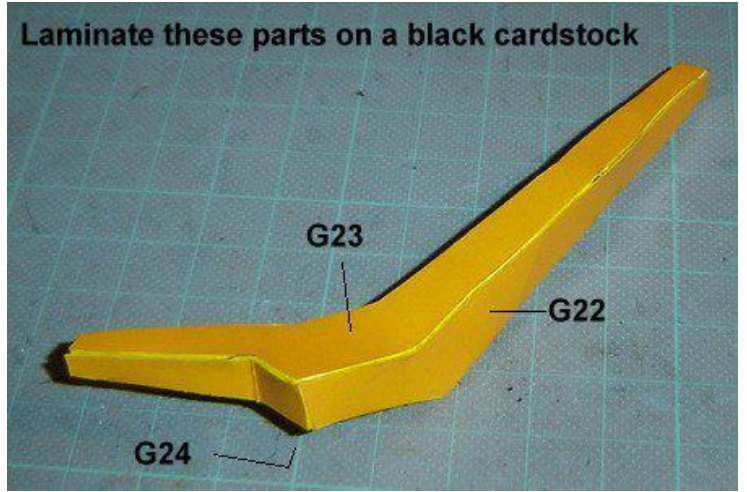

step067

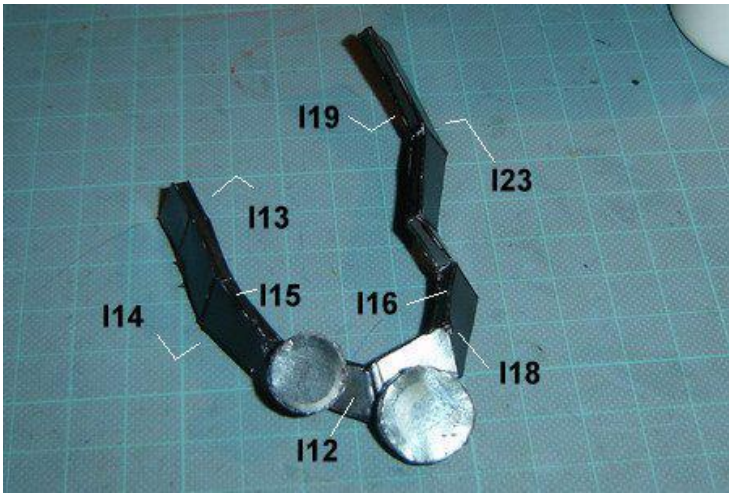

step064

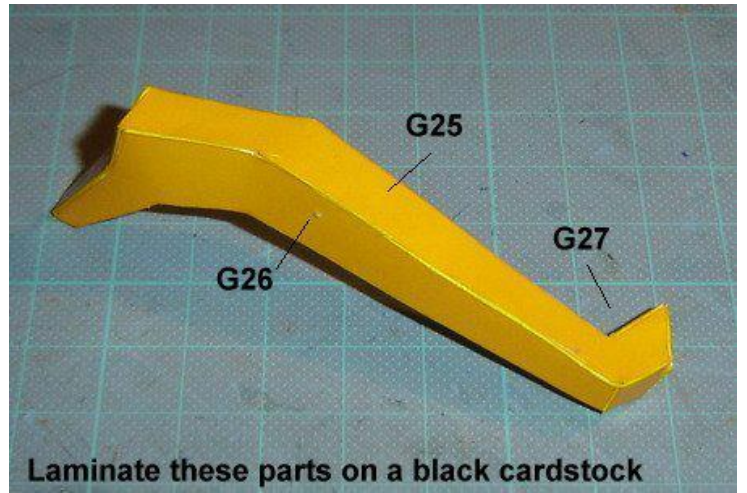

step068



step065



step069



step070

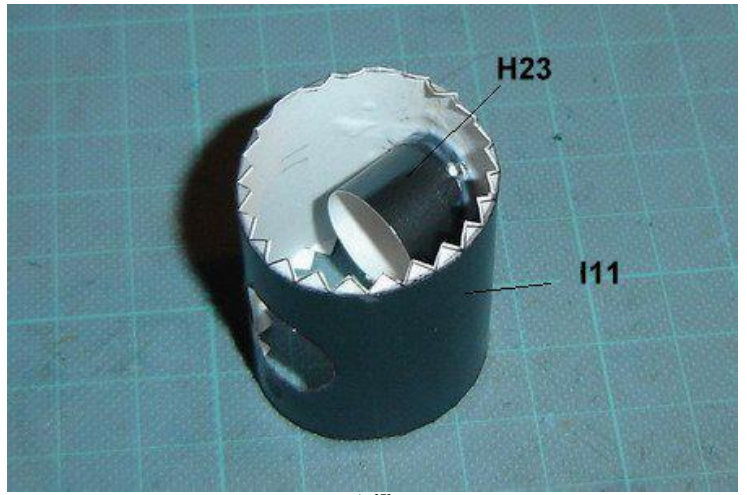

step073

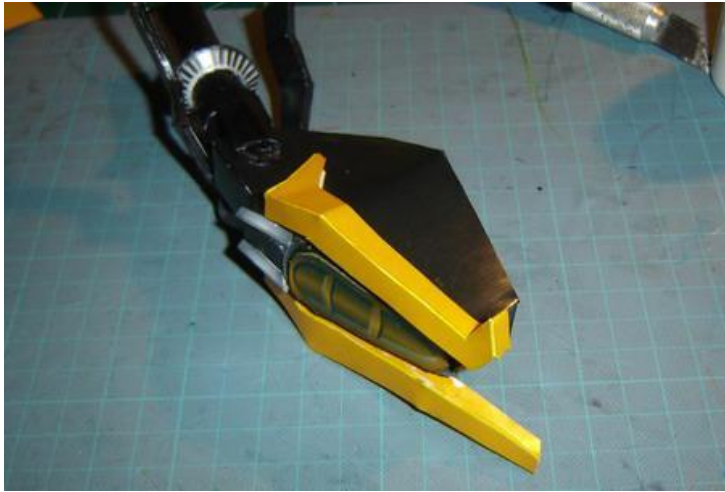

step070a

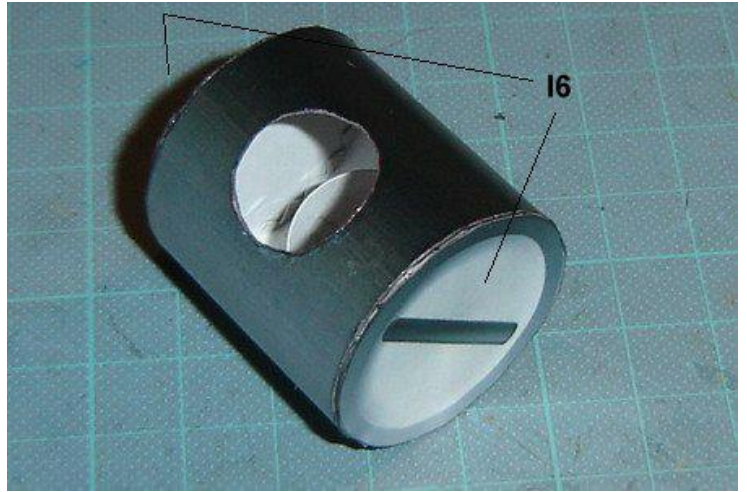

step074

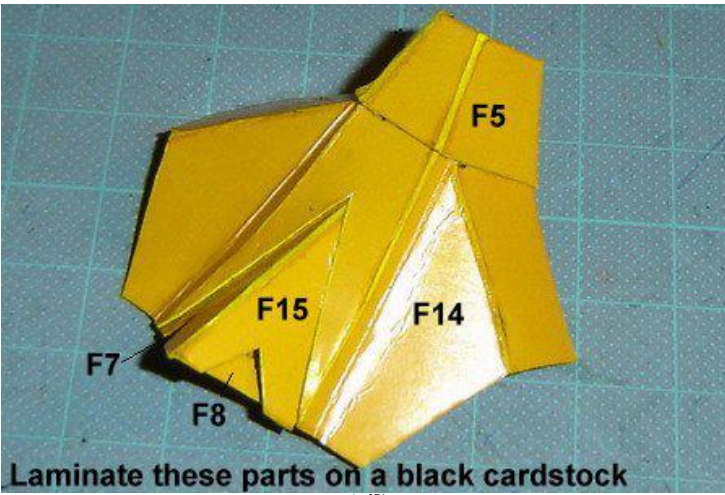

Laminate these parts on a black cardstock

step071

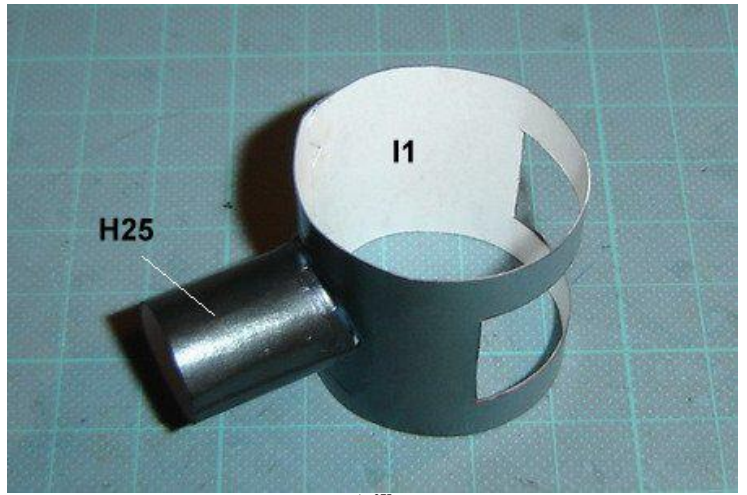

step075

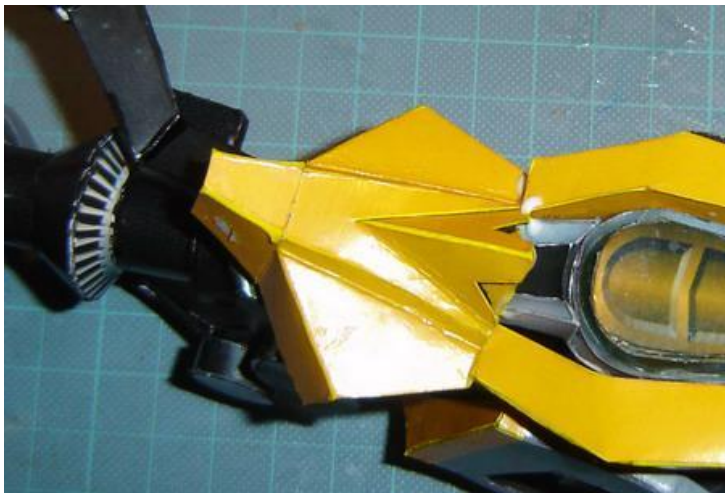

step072



Leave I11 free to rotate inside part I1

step076

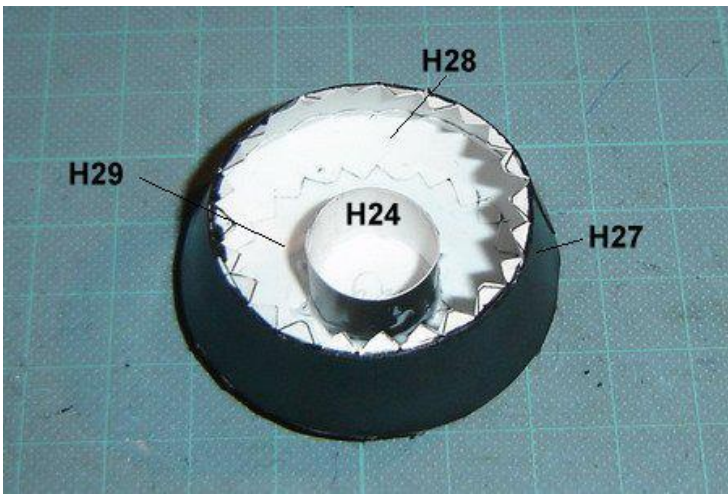

step077



step081

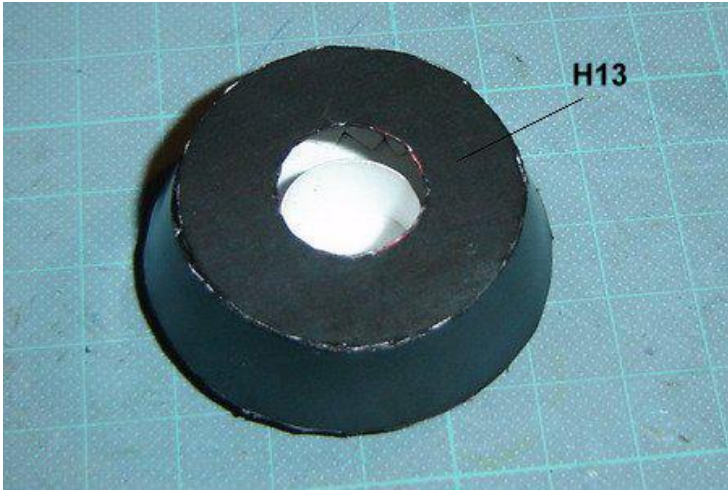

step078



step082

Laminate this part on a black cardstock



step079

Leave H25 free to rotate inside part H24



step083



step080

Leave 18 free to rotate inside part H23

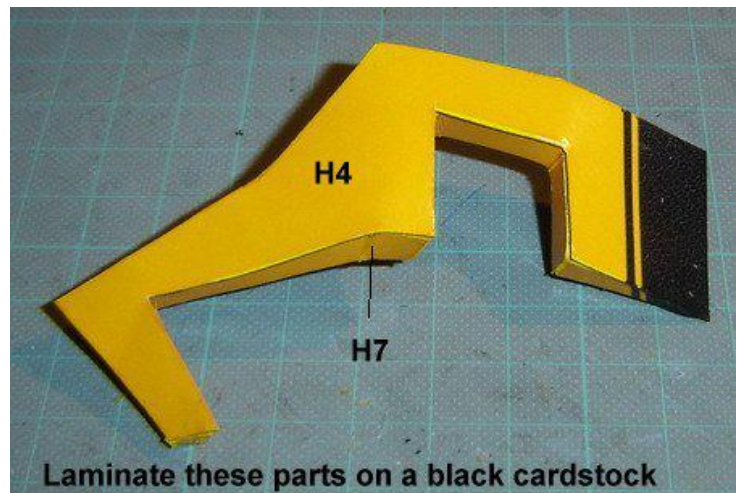

step084

Laminate these parts on a black cardstock

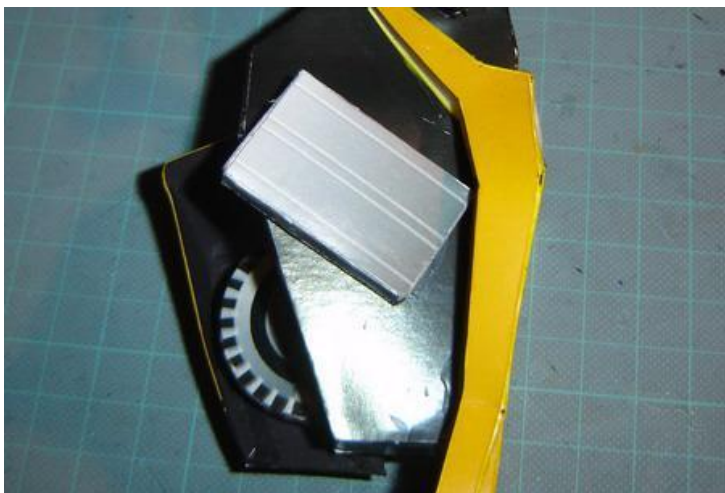
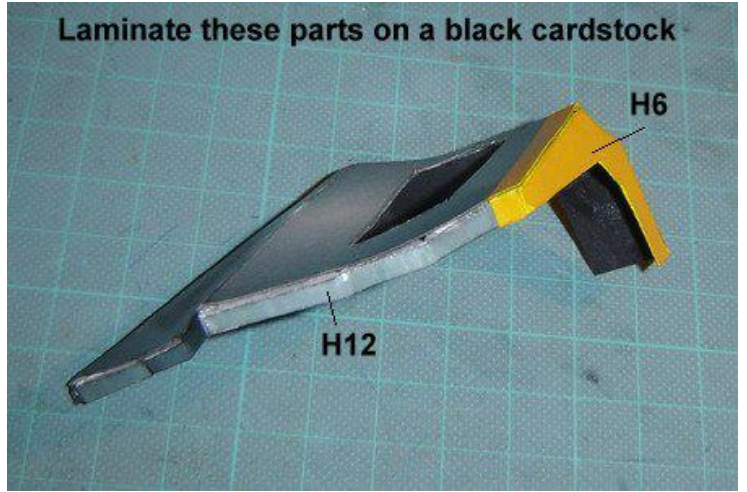
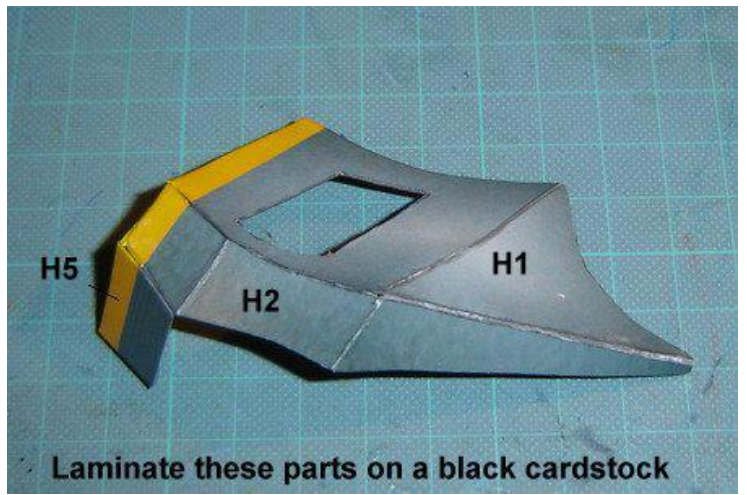
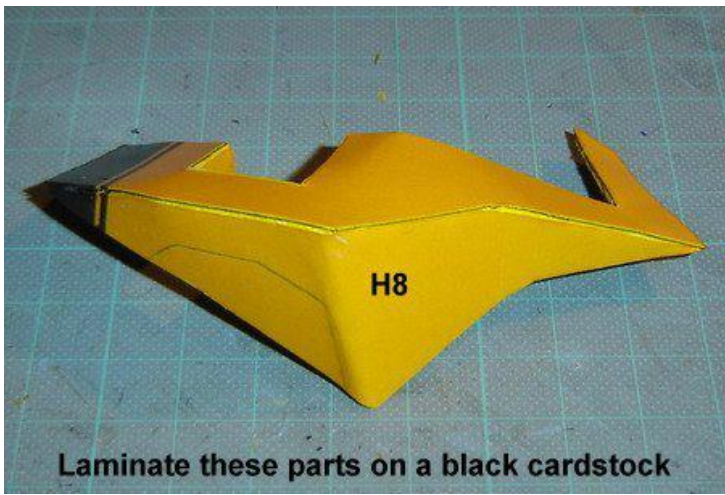

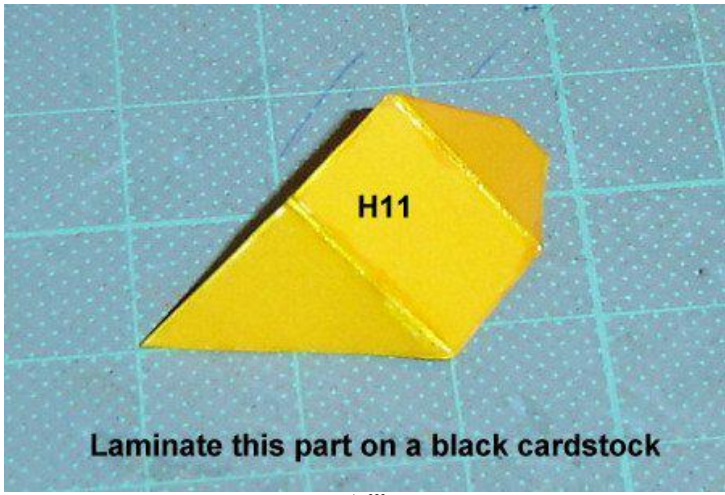

Laminate this part on a black cardstock

step090

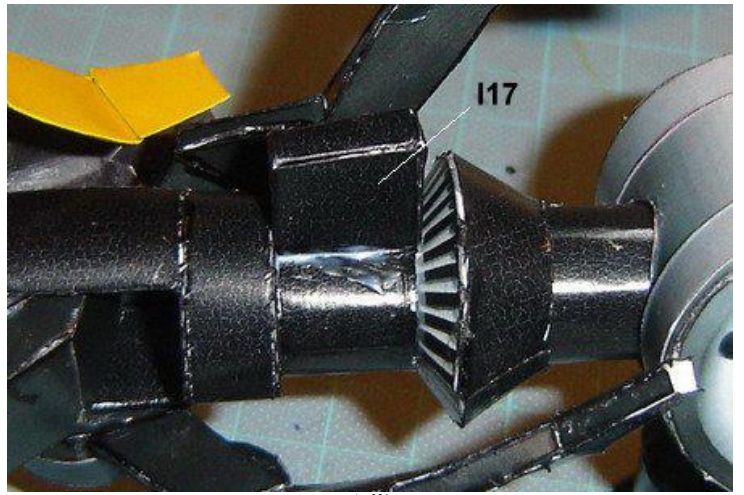

step094

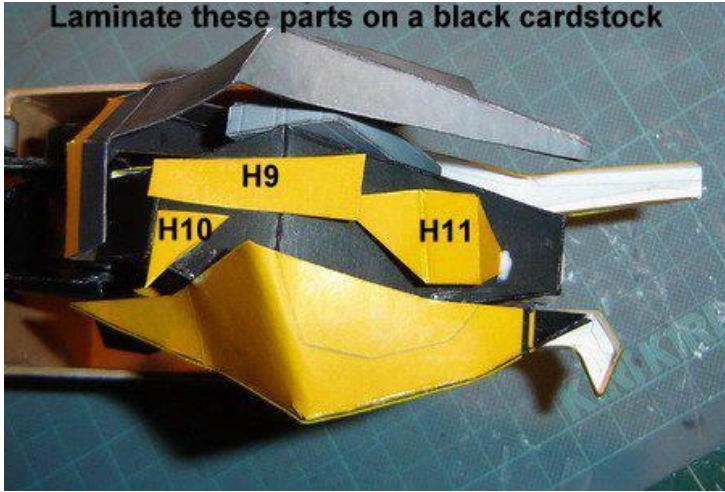

Laminate these parts on a black cardstock

step091

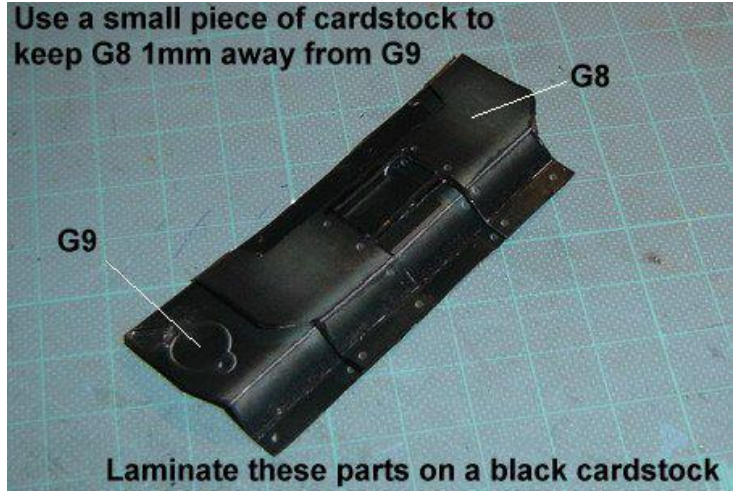

Use a small piece of cardstock to keep G8 1mm away from G9

Laminate these parts on a black cardstock

step095



step092

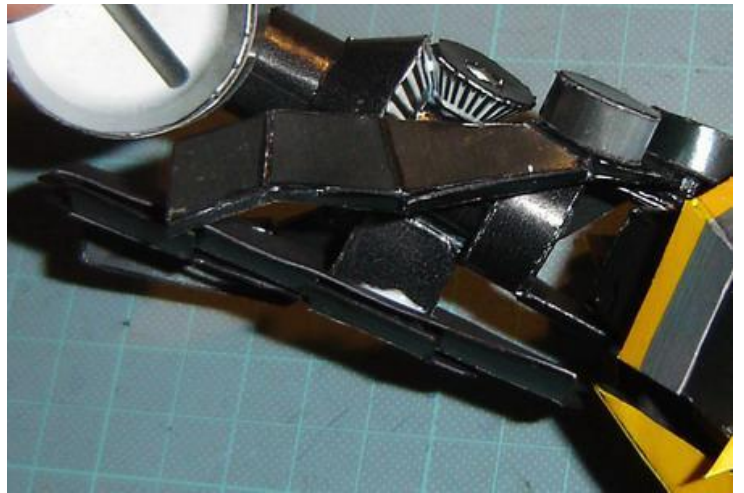

step096

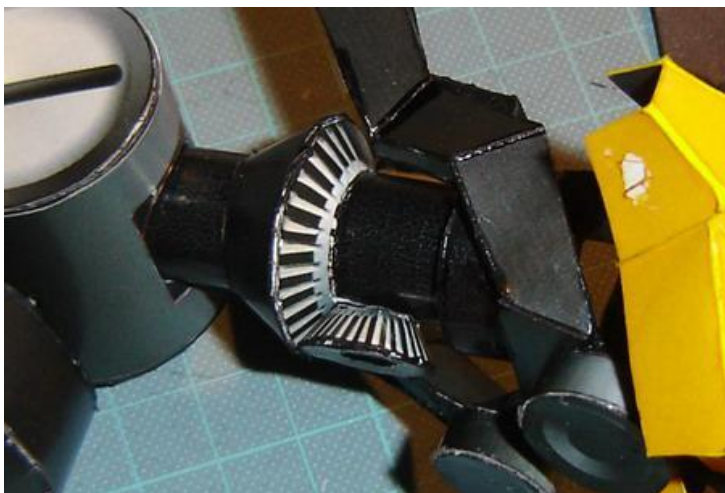

step093



step096a

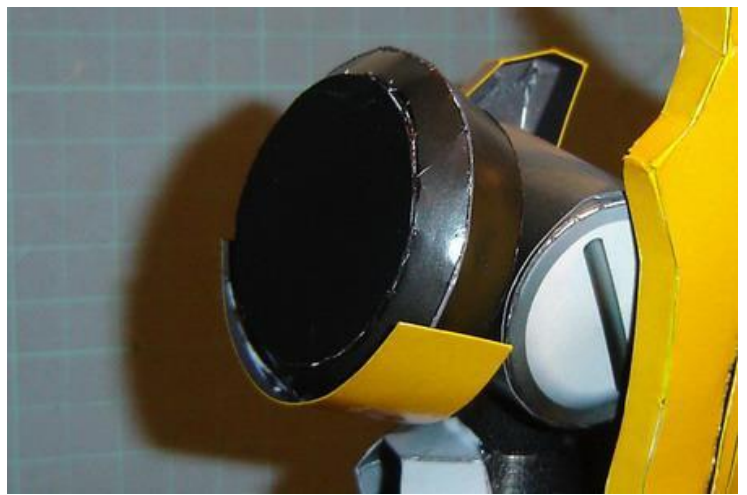
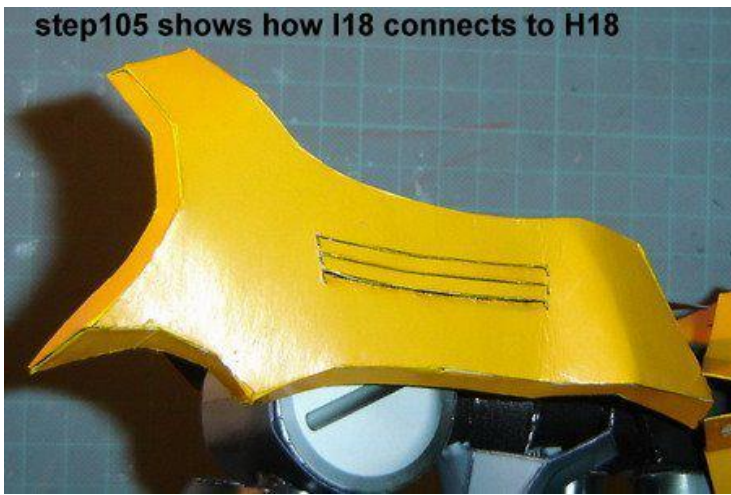
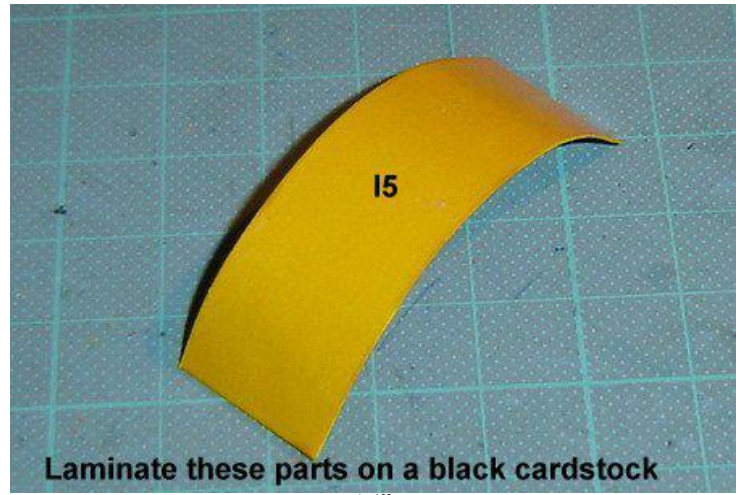
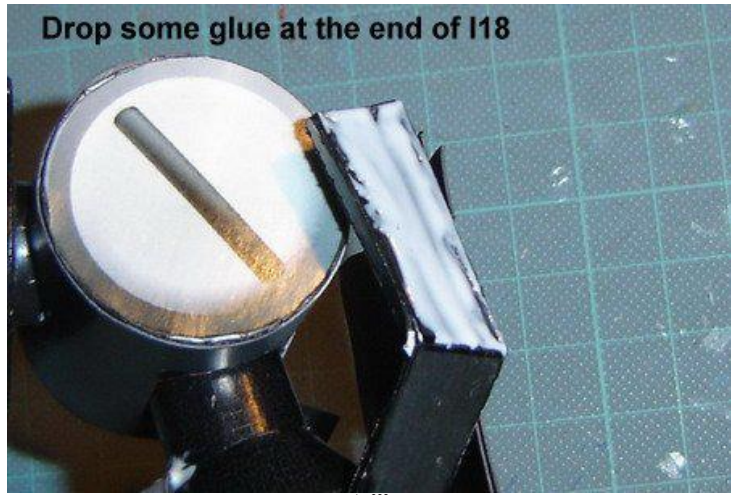
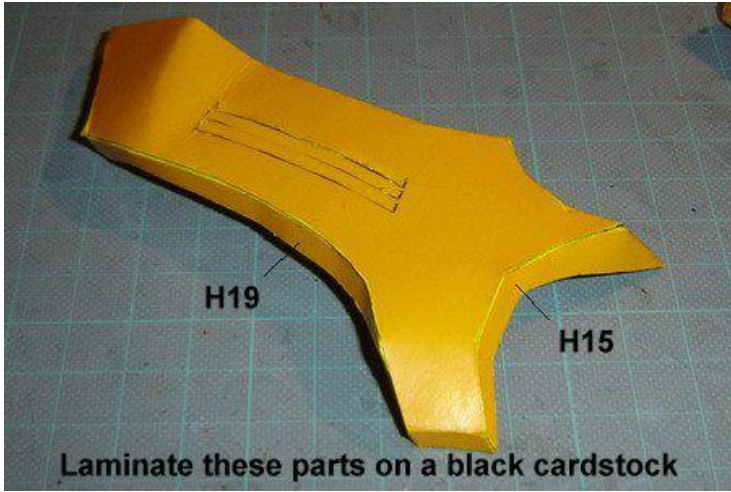
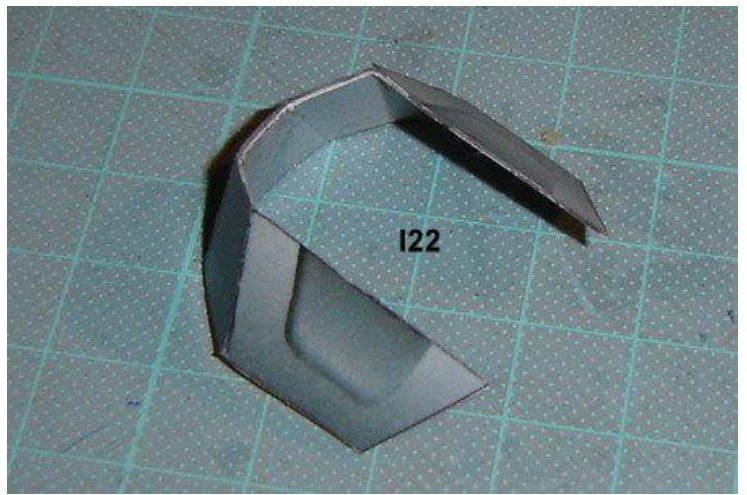
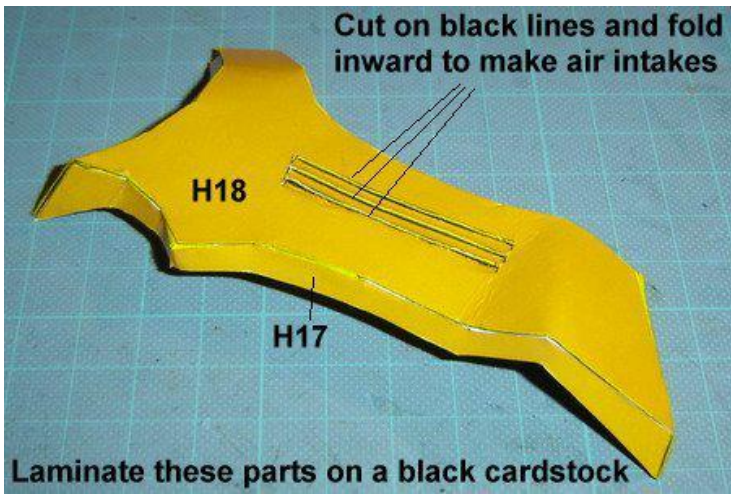

Laminate these parts on a black cardstock

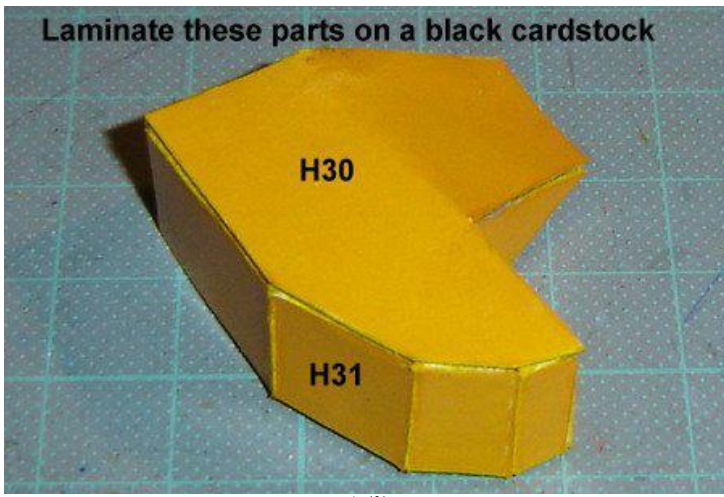

step104



step107a

Connect to I14 end



step105

Connect I2 to G21 (leg to foot)



step106

Thank you for download  
Bumblebee Legs!



step107