

JSC

PANCERNIK

Viribus Unitis

NR 259

MODEL KARTONOWY

1:250



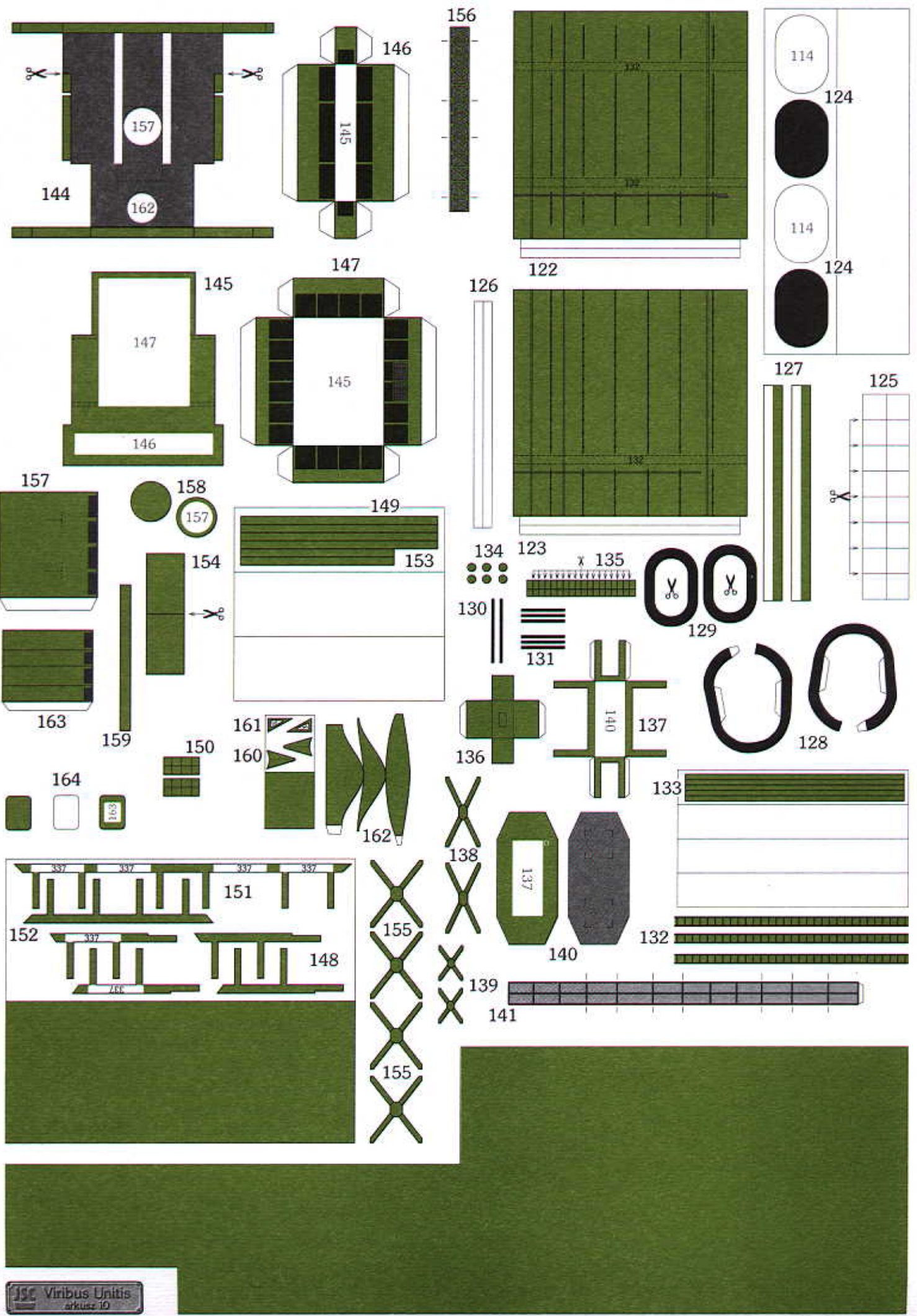

rys. 1

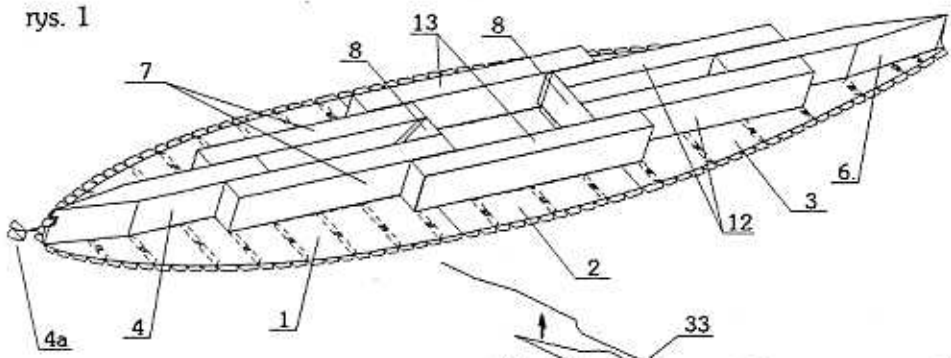

rys. 2

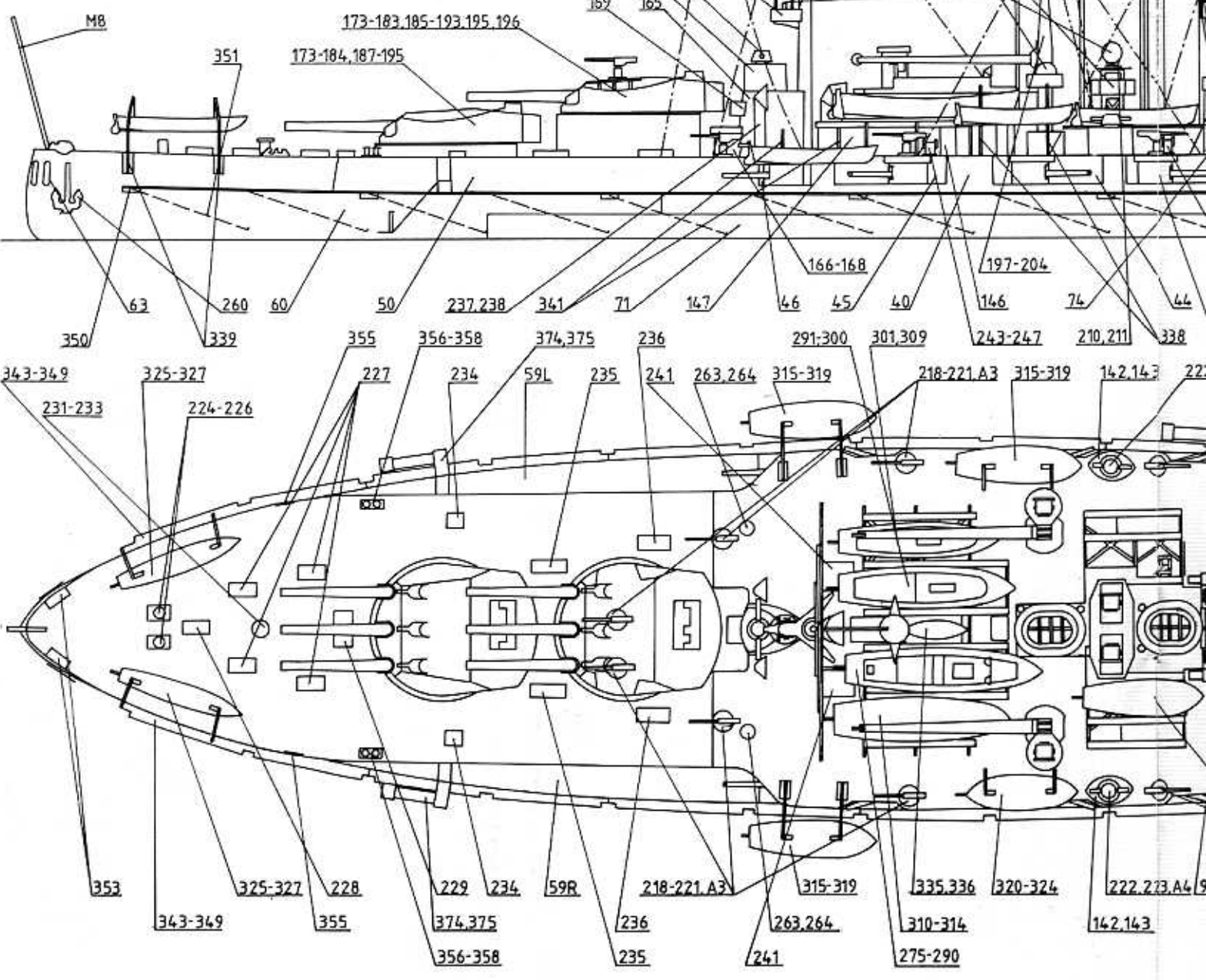
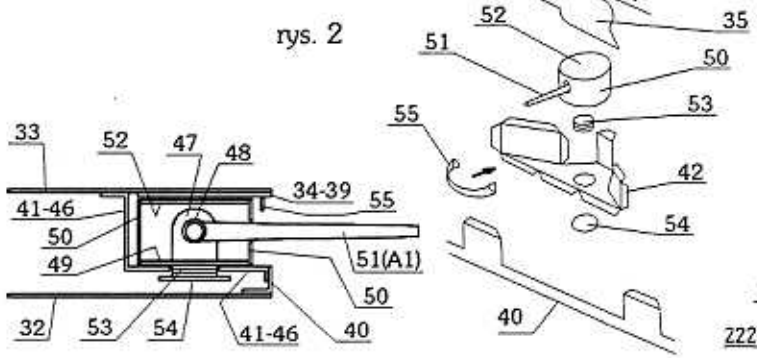

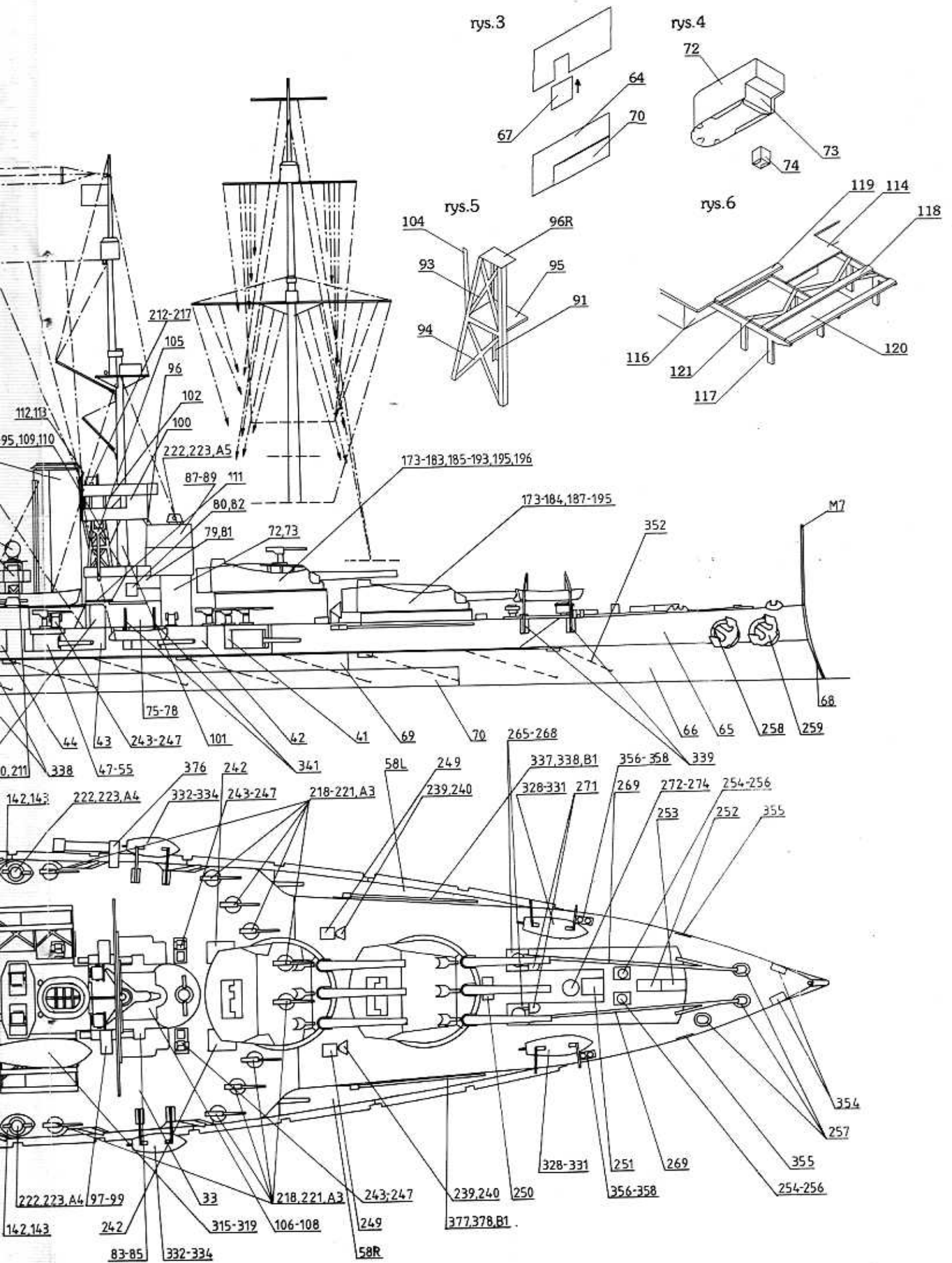

rys. 3

rys. 4

rys. 5

rys. 6

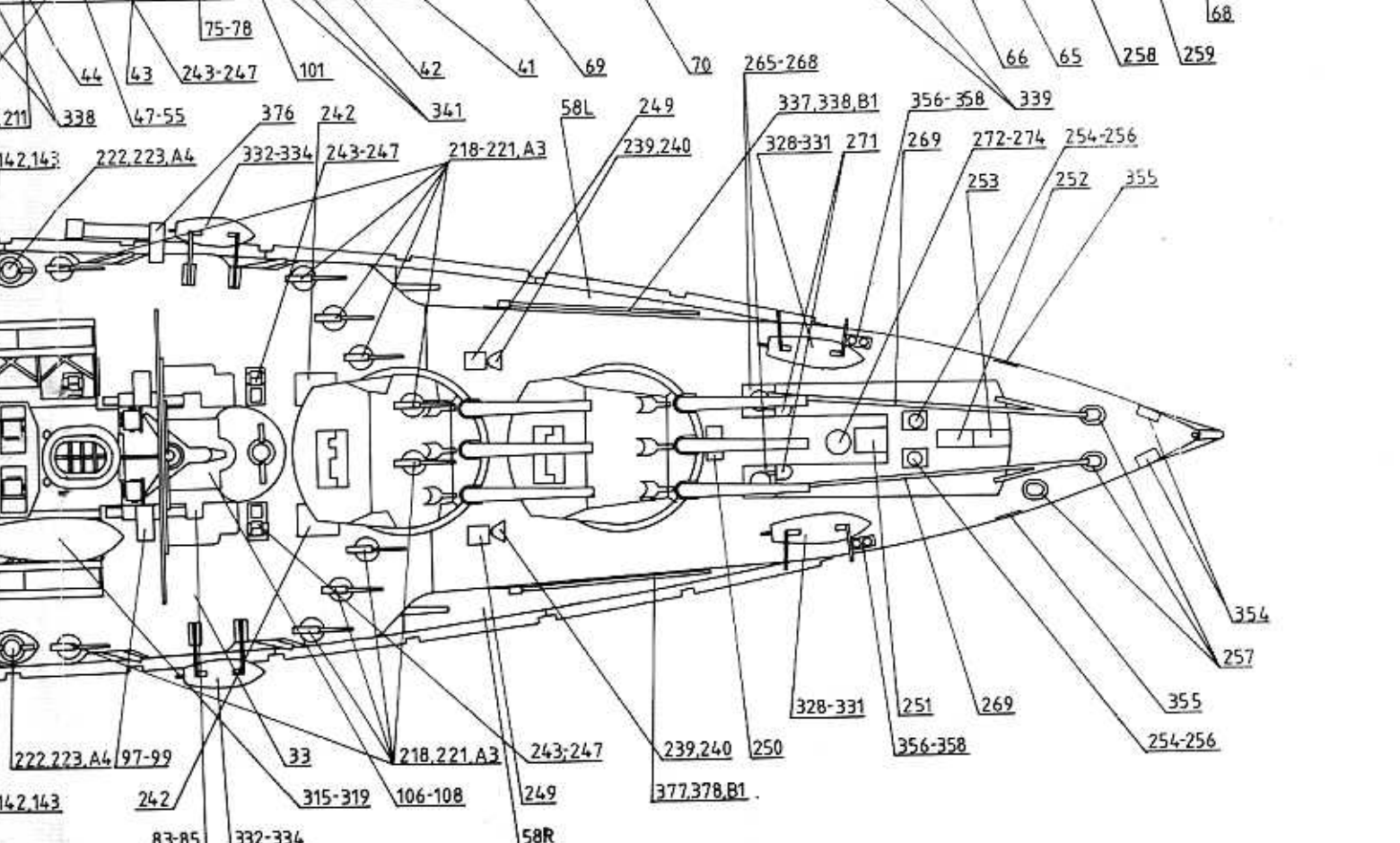
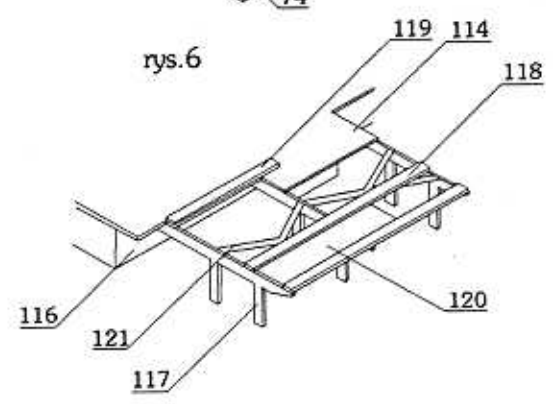
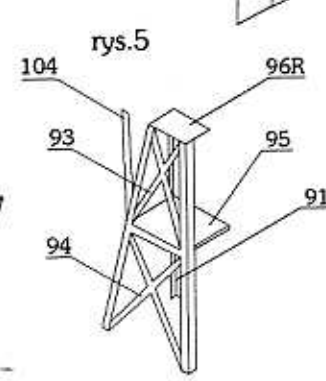
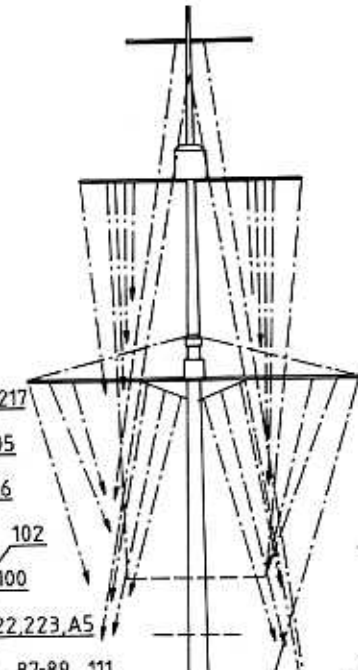
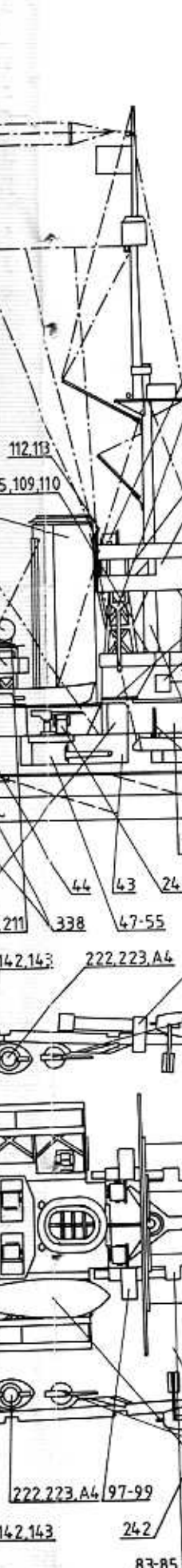
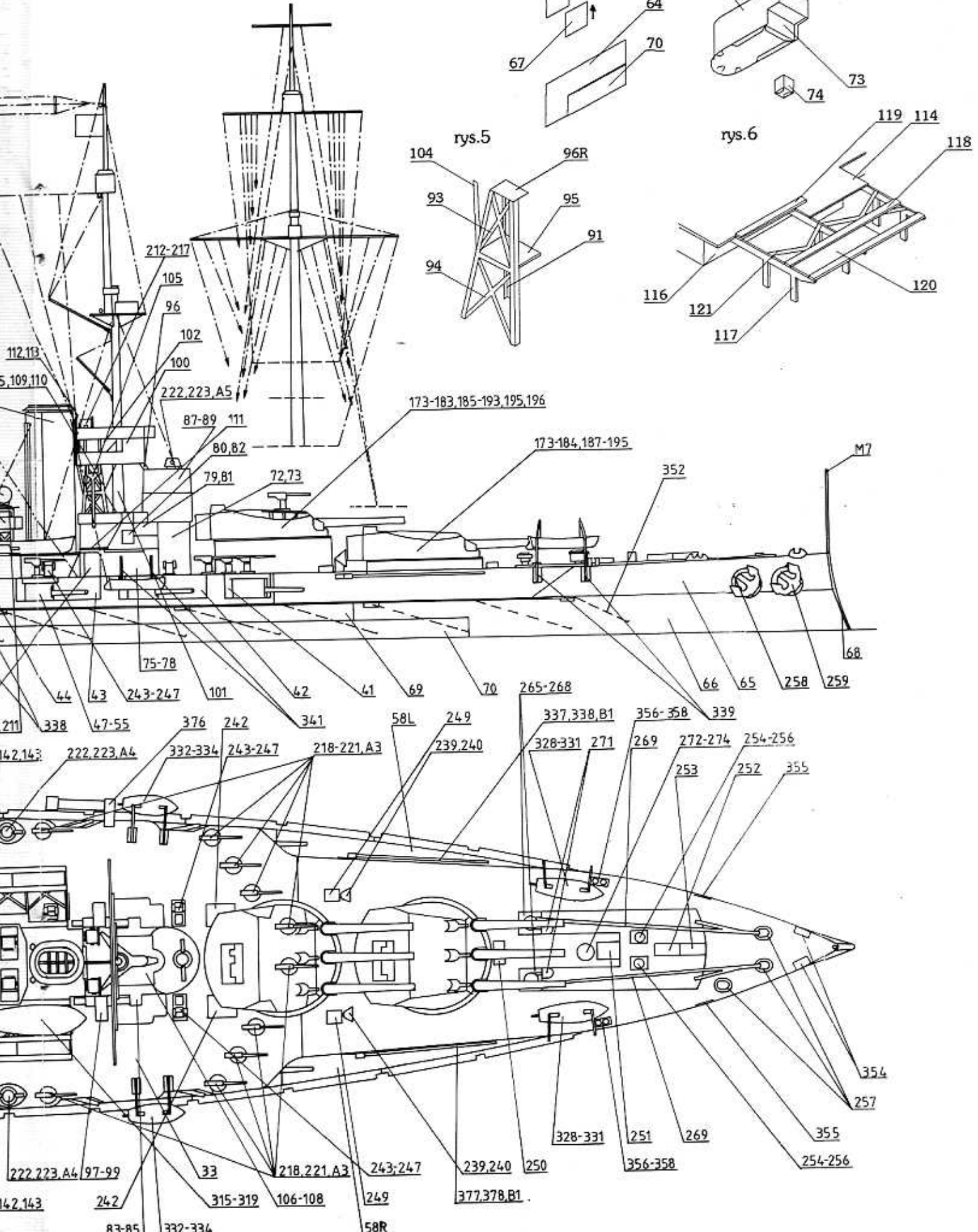

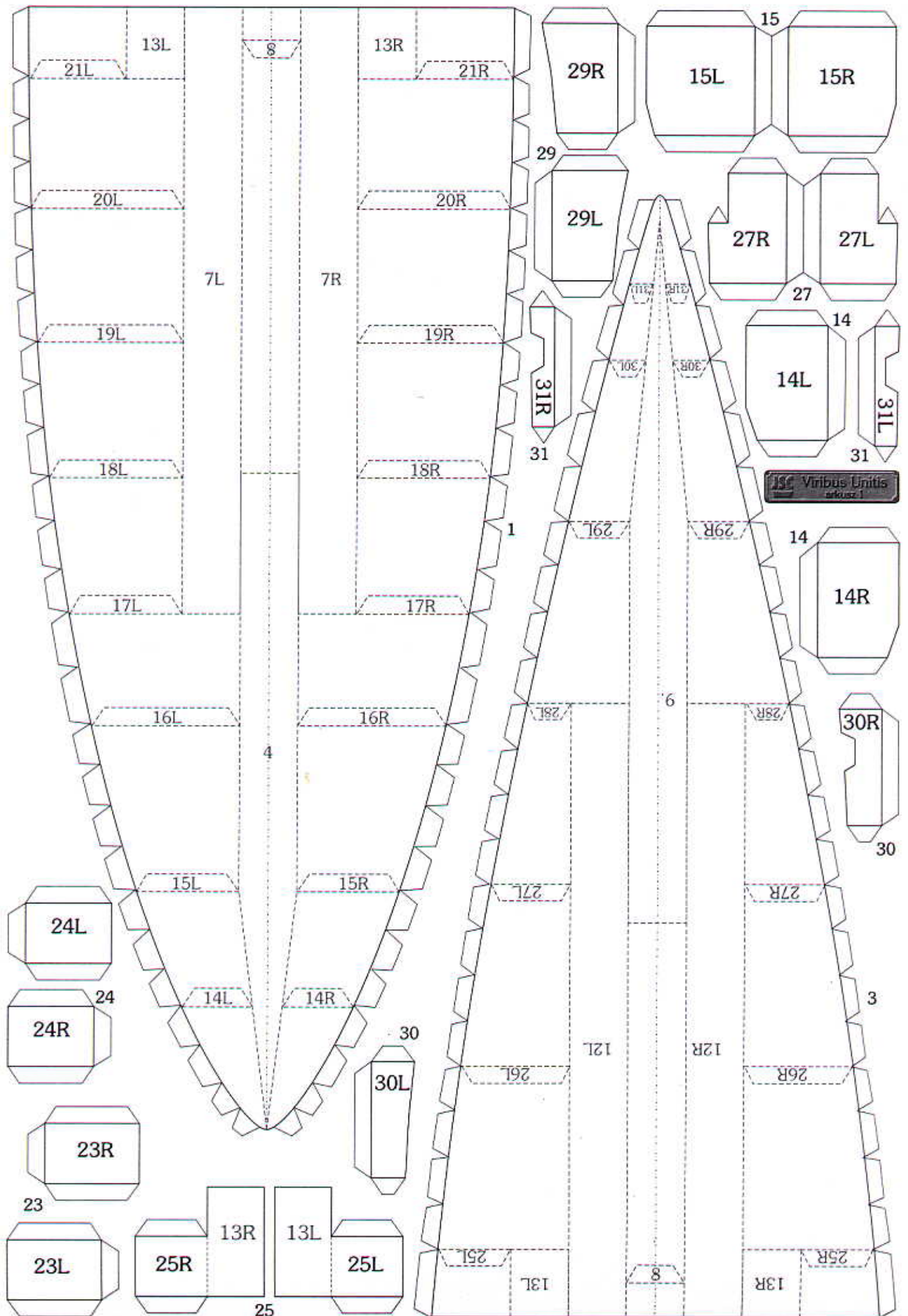

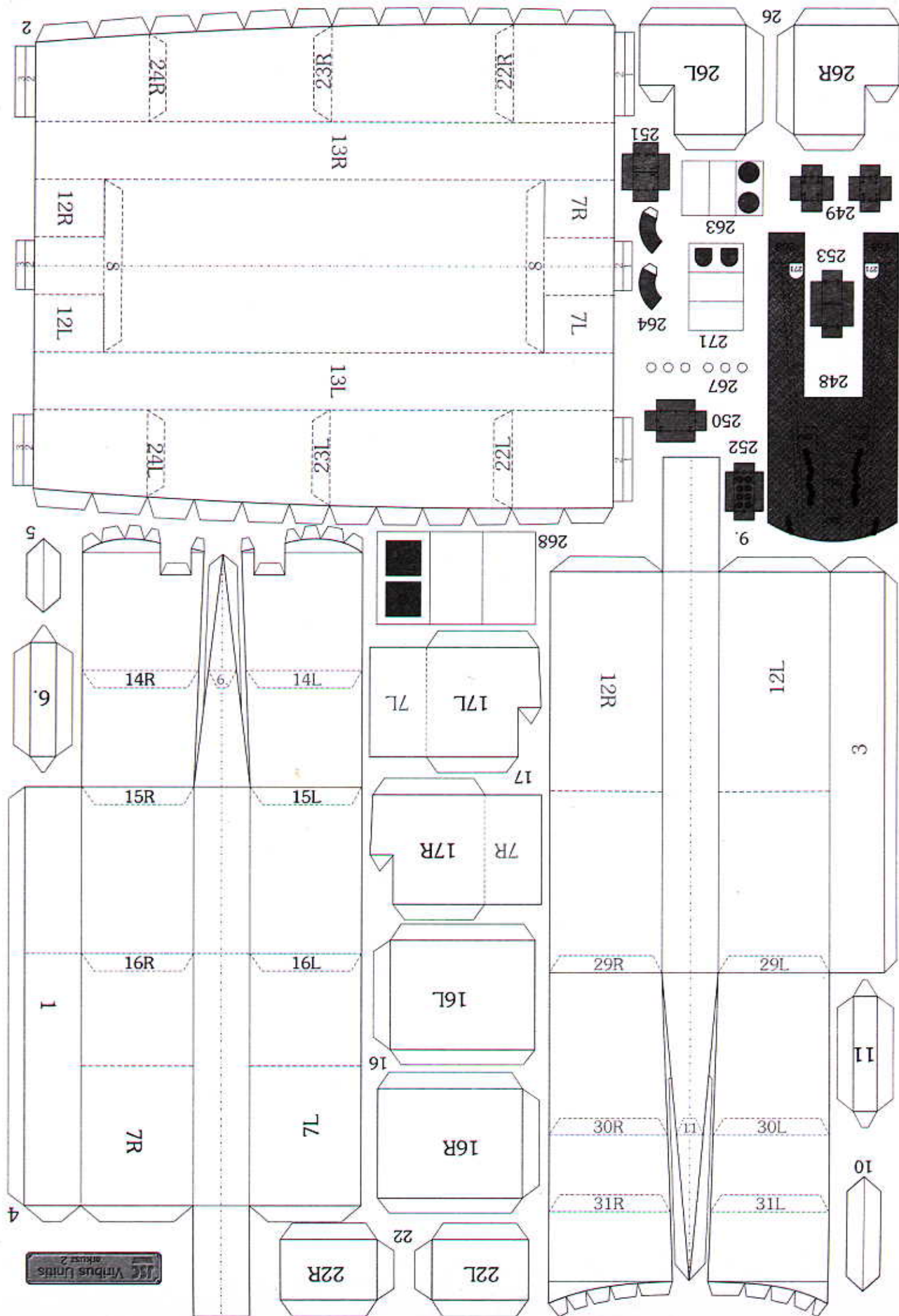

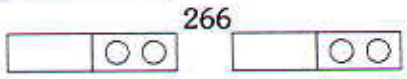
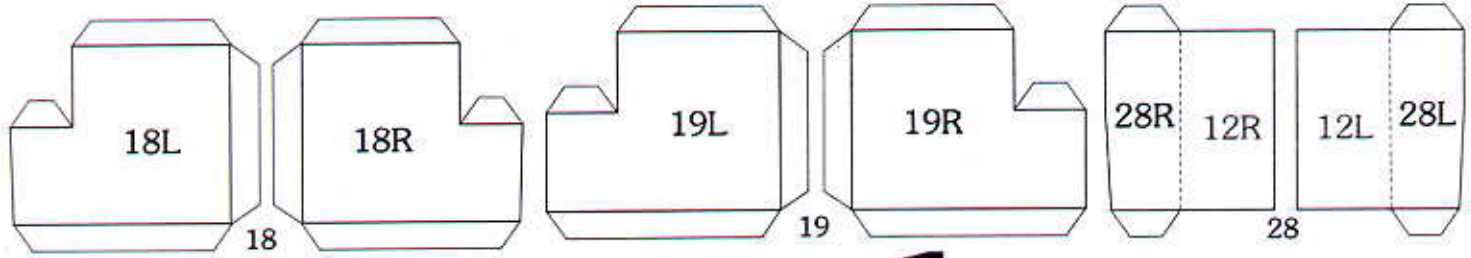
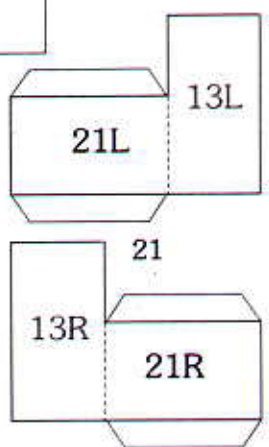
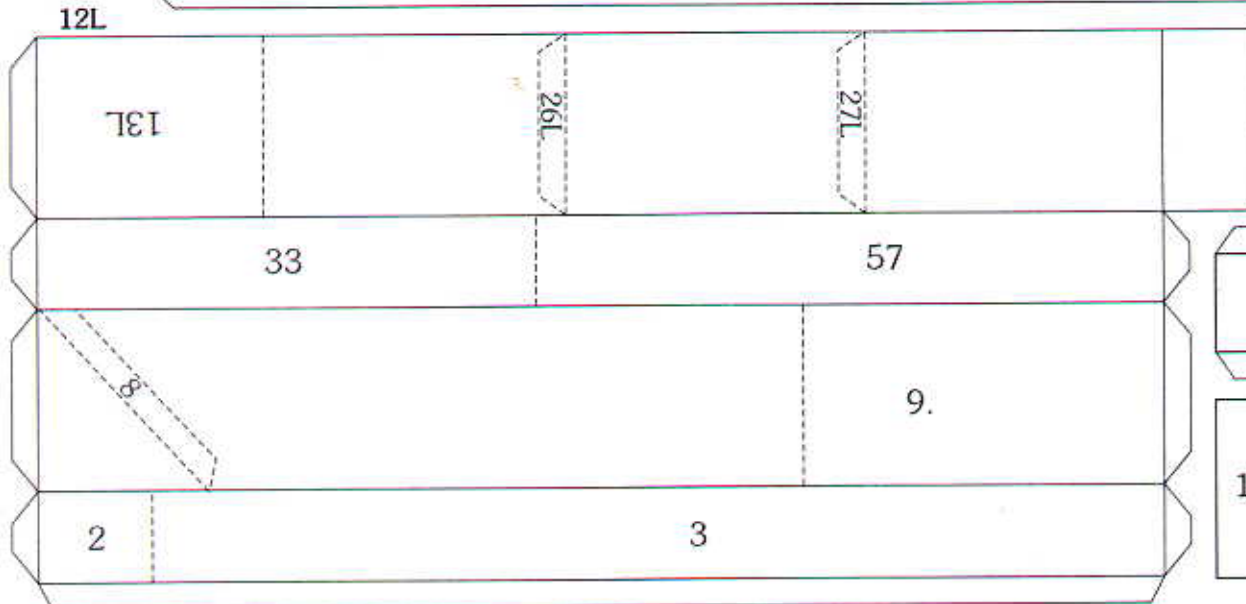
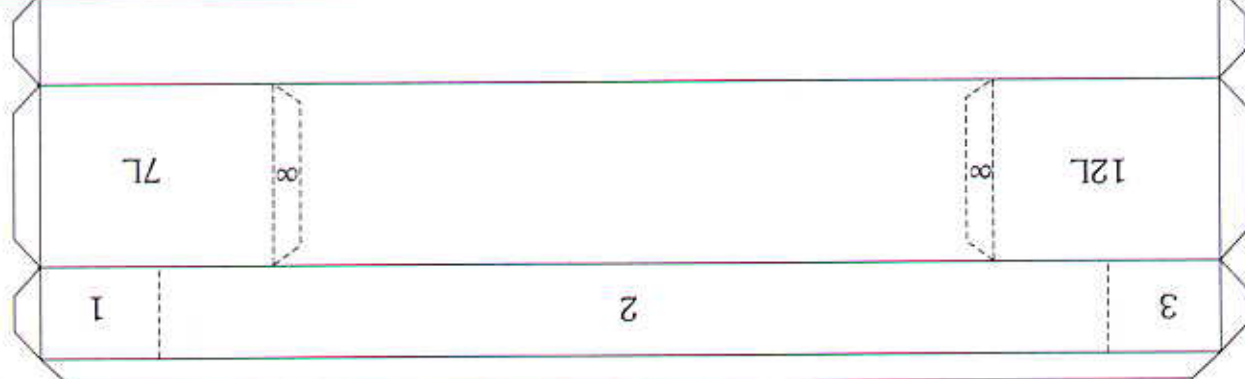
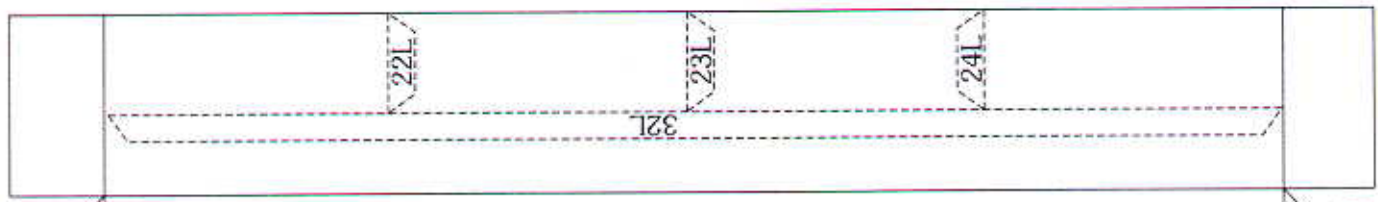
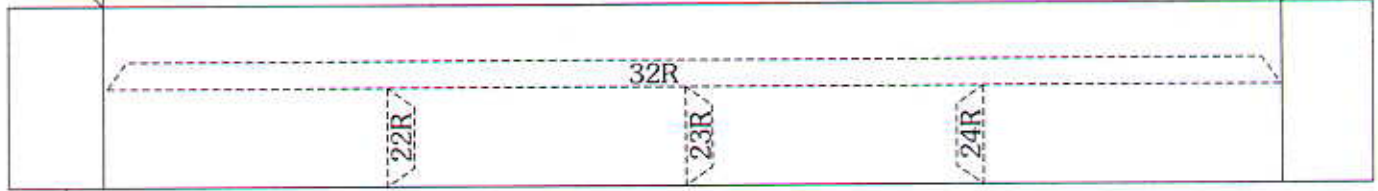
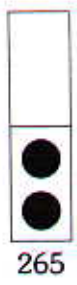
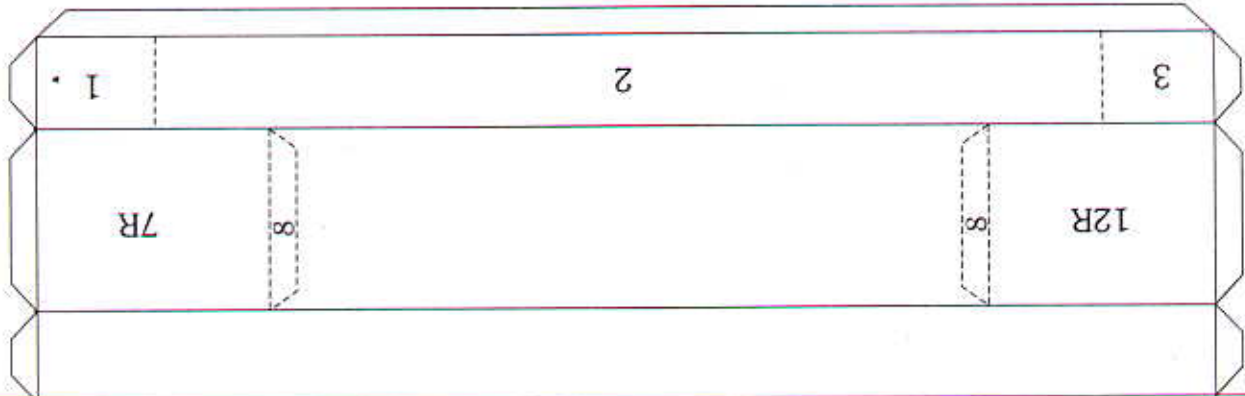

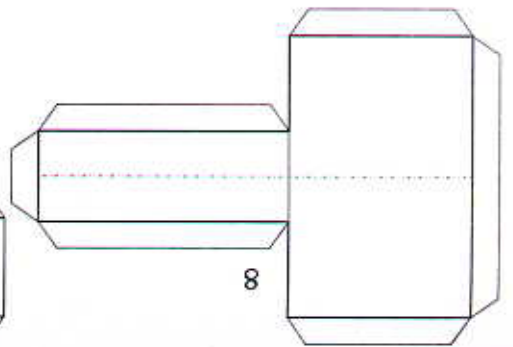
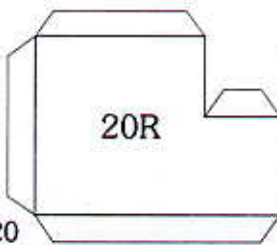
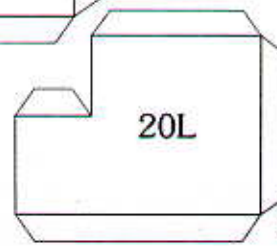
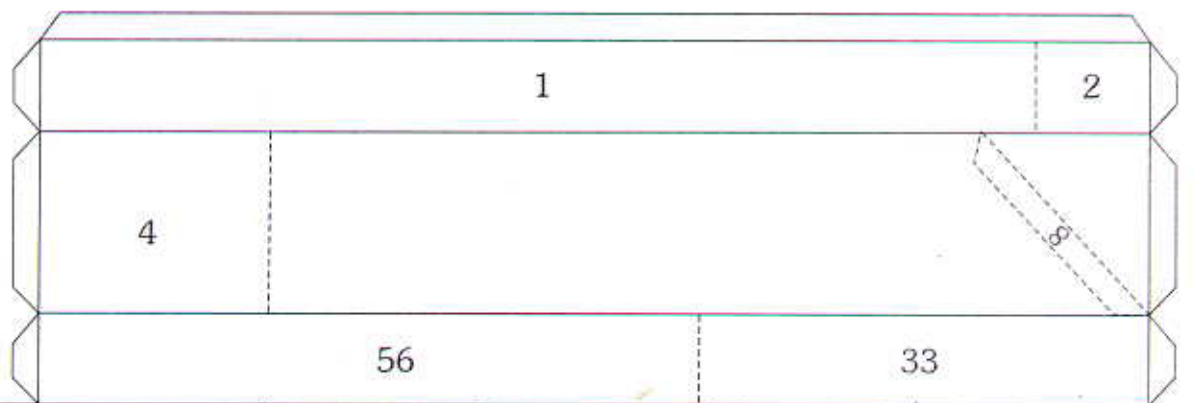
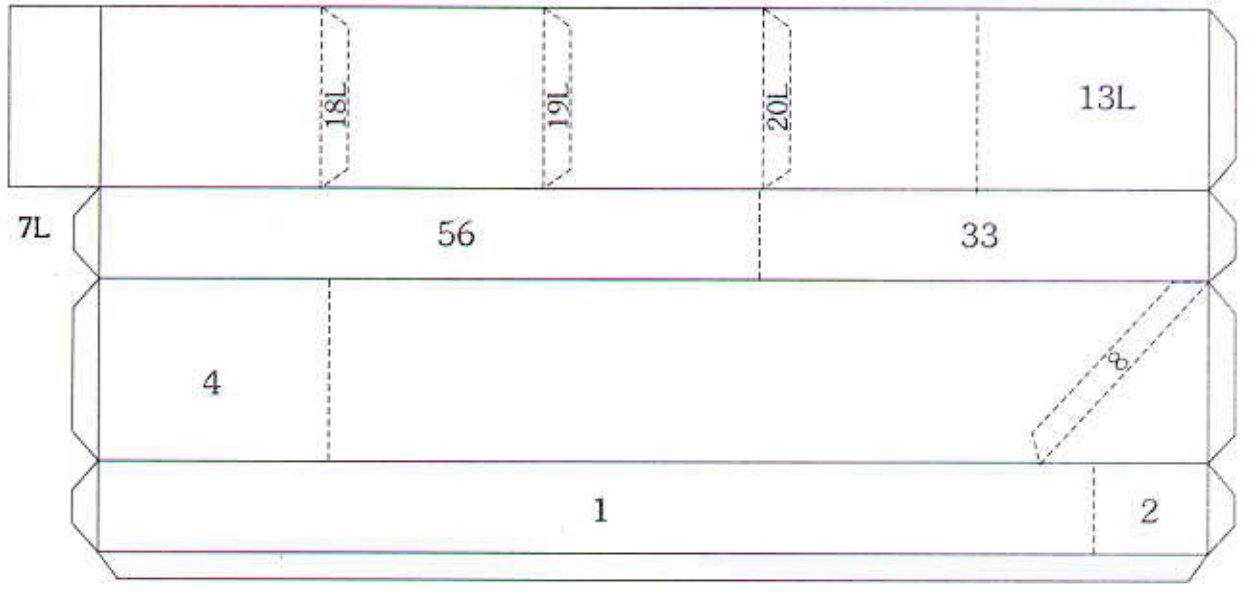
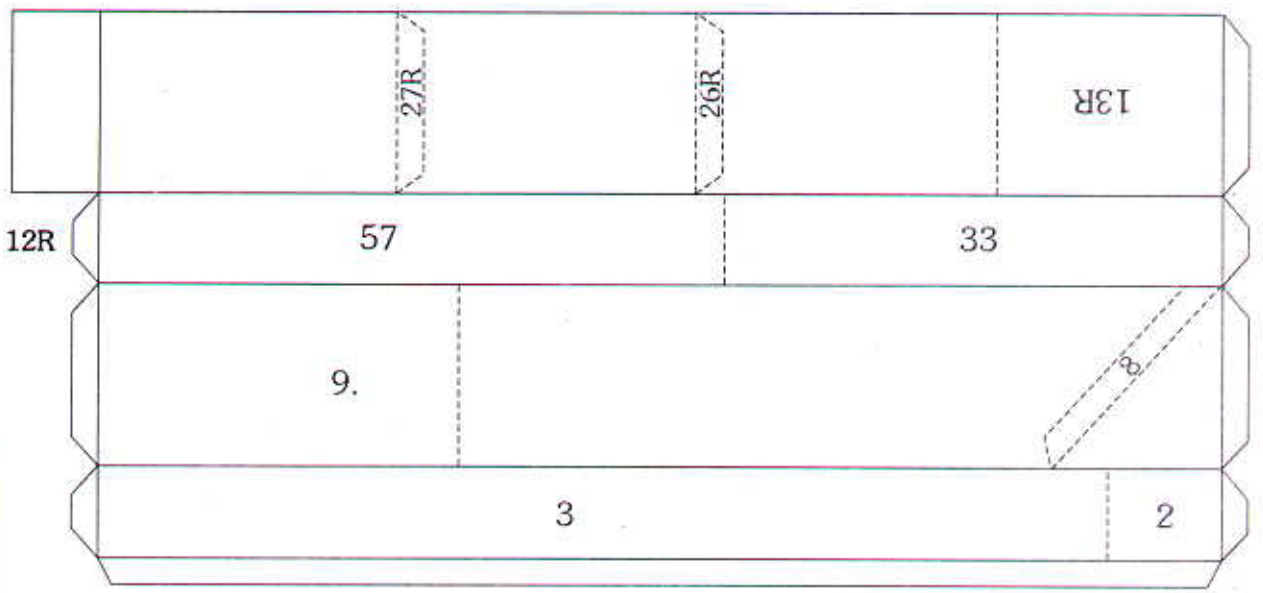
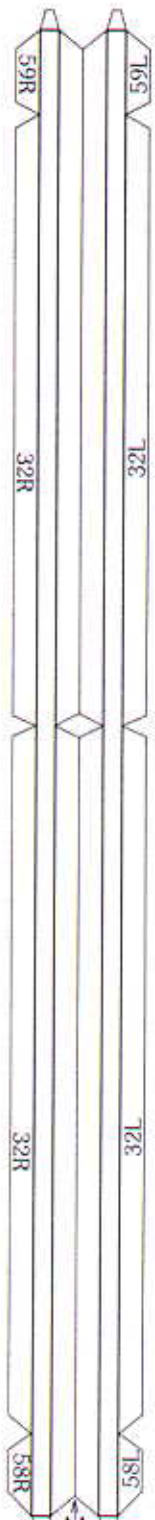

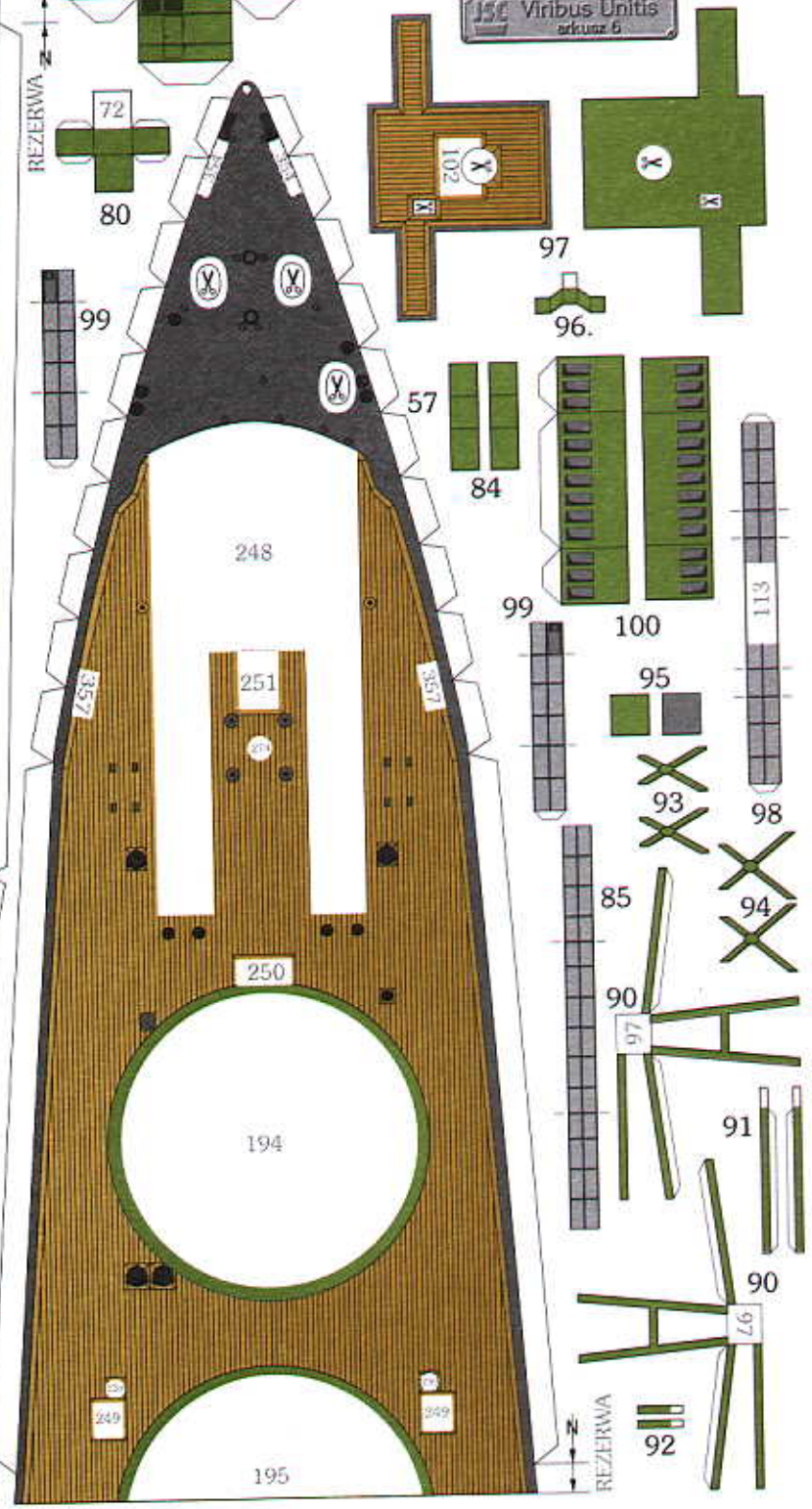
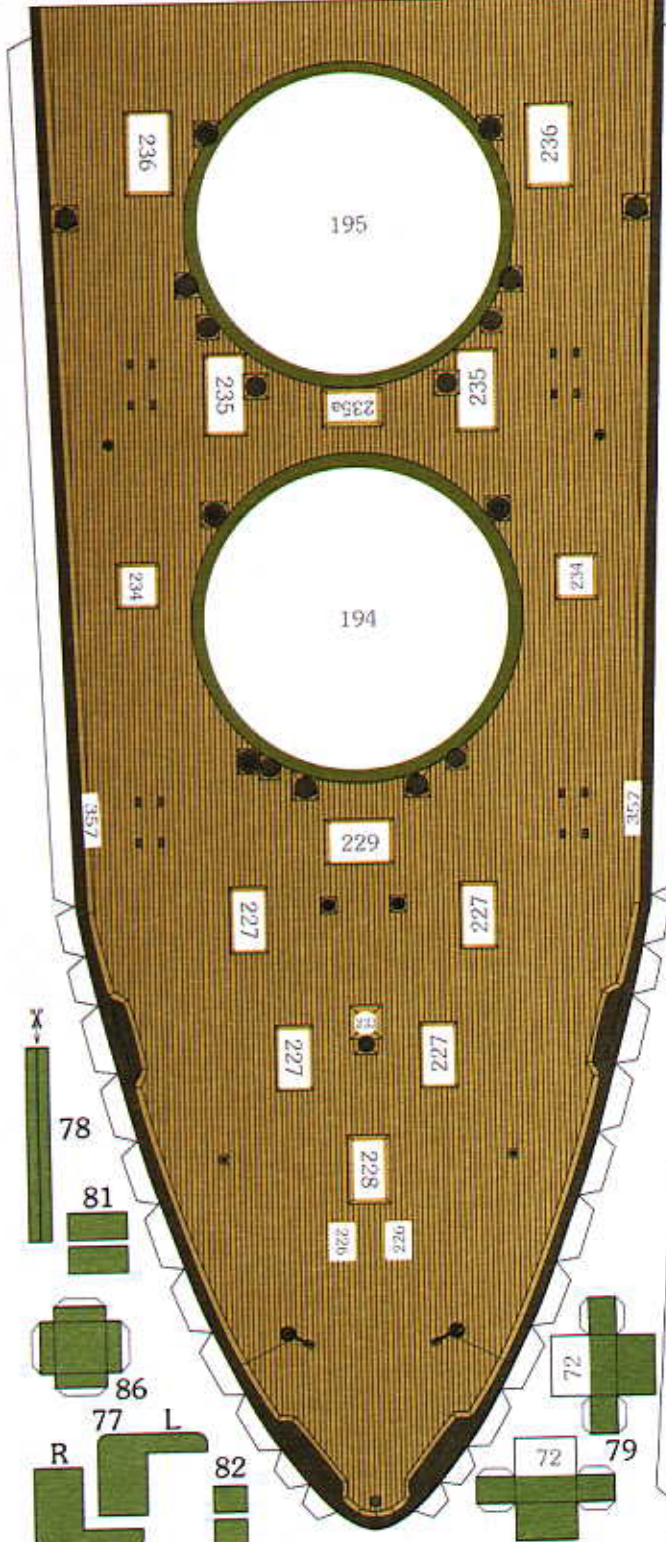
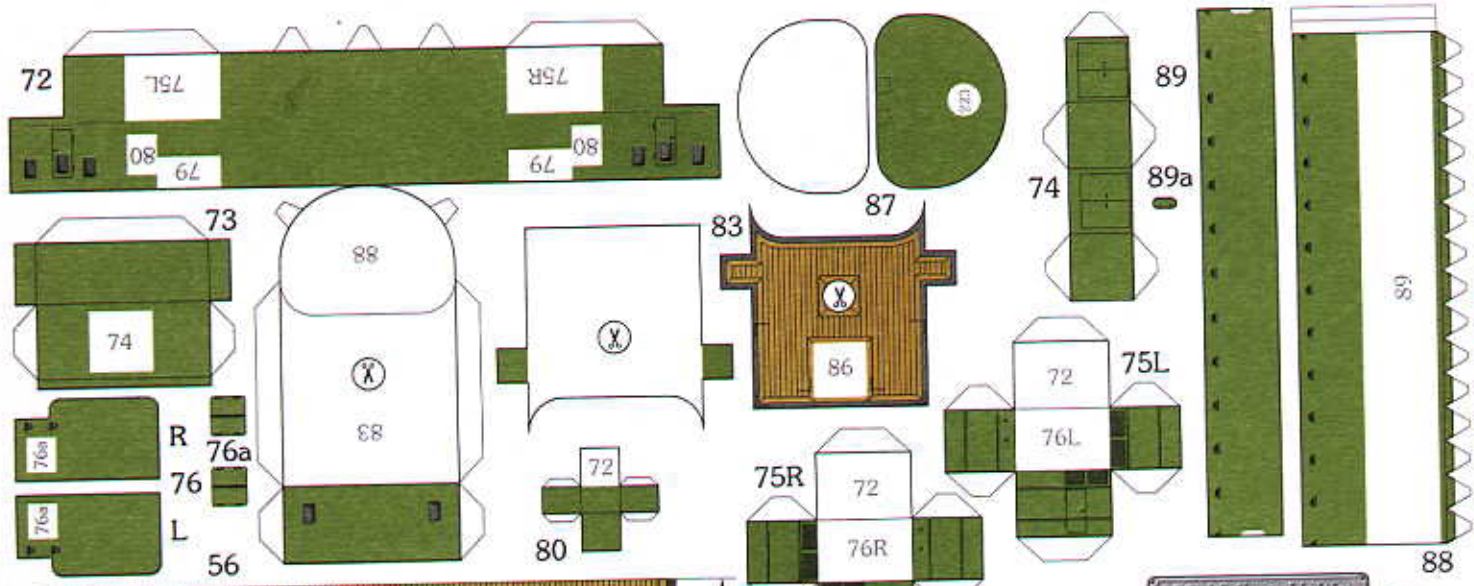

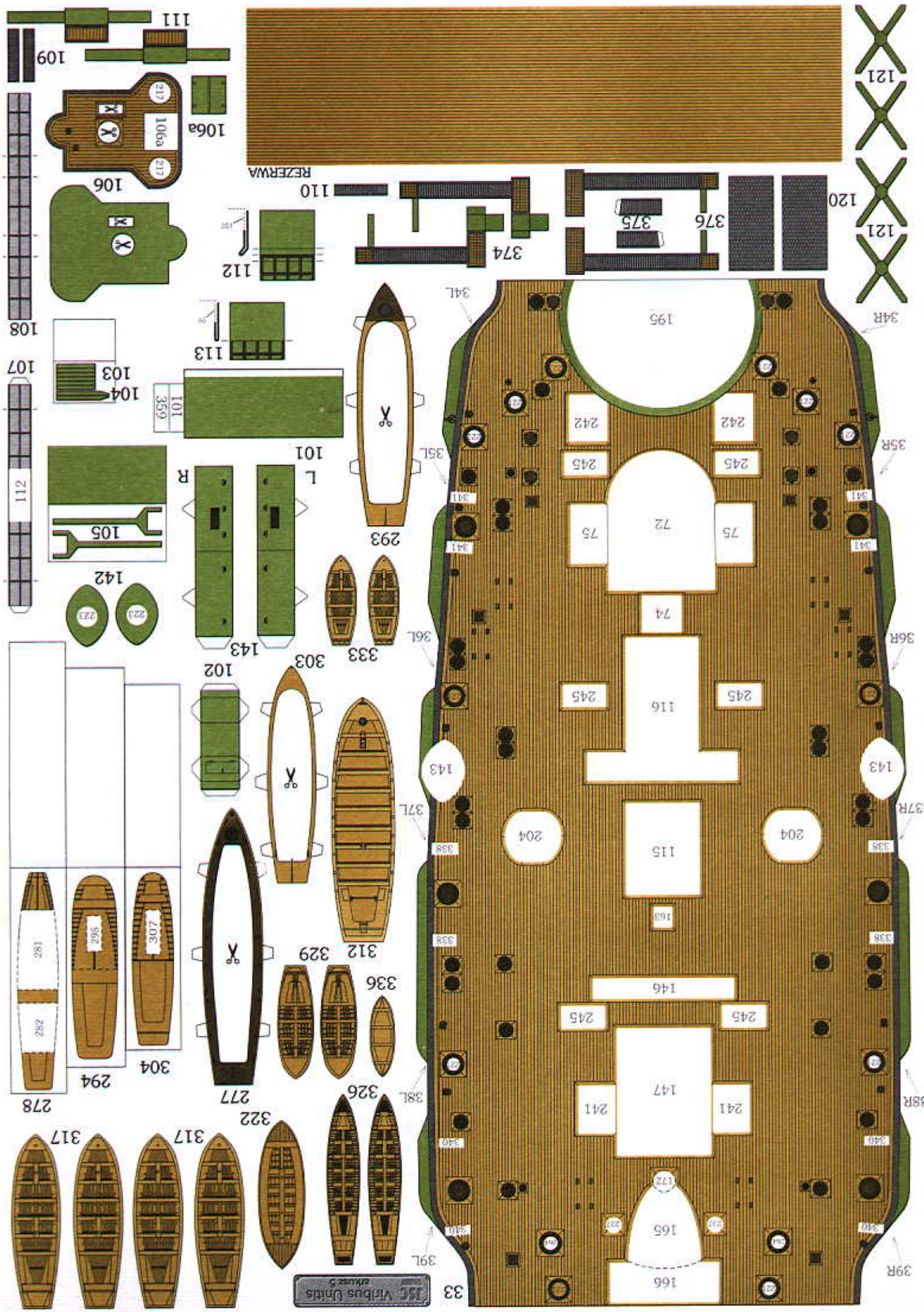

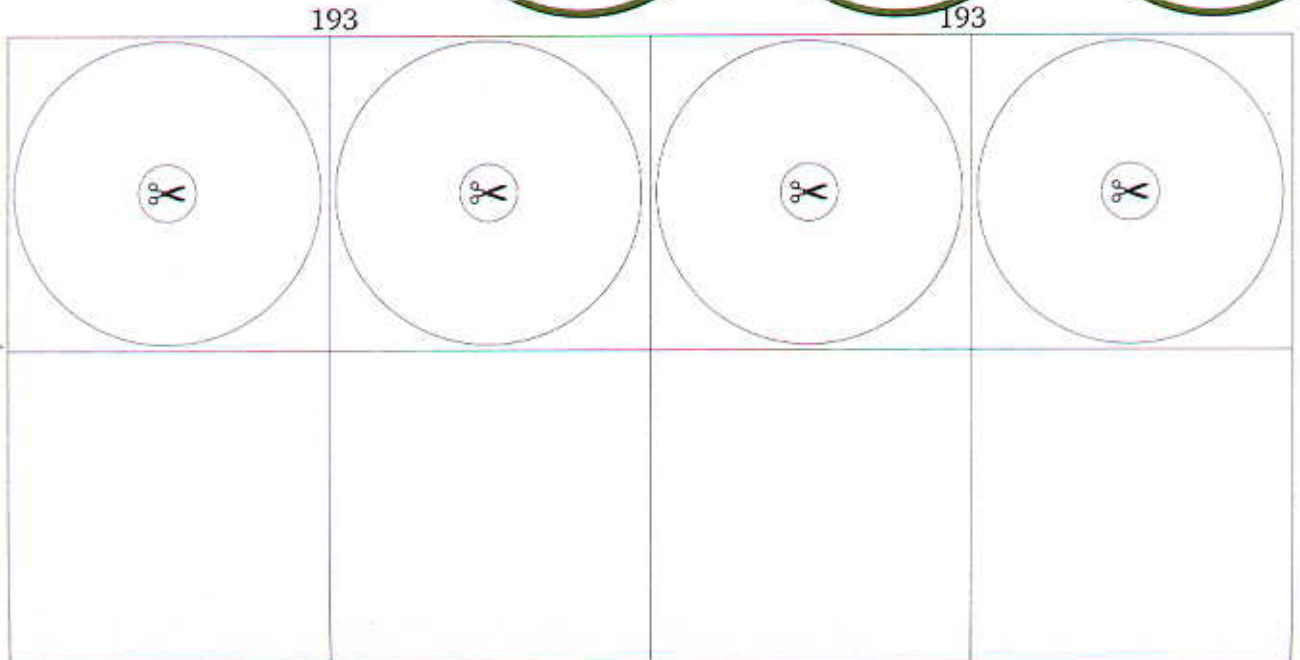
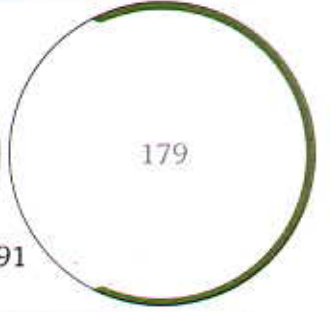
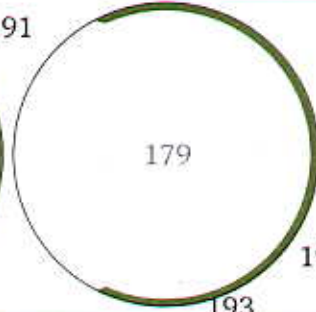
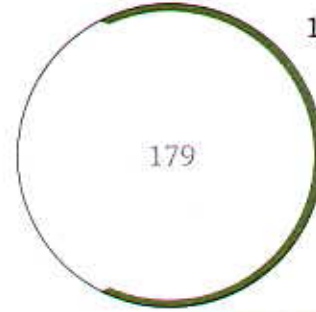
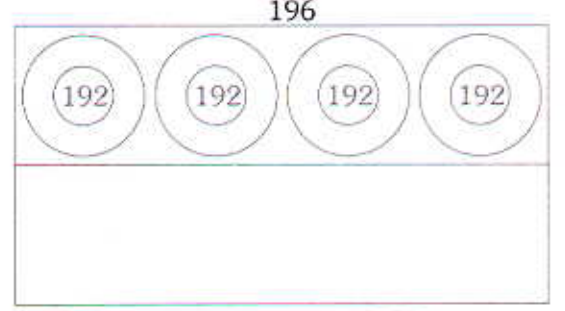
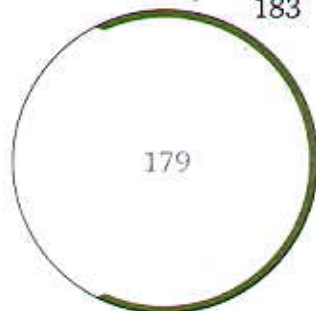
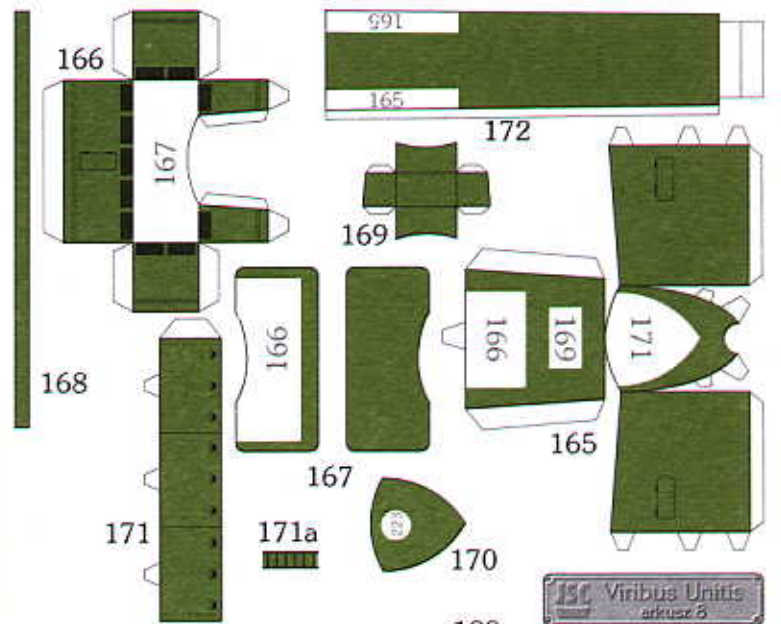
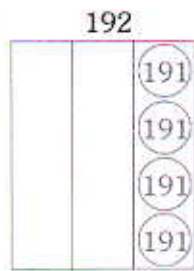
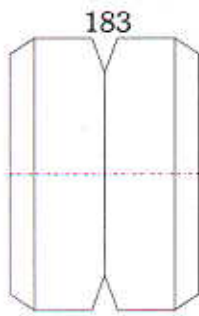
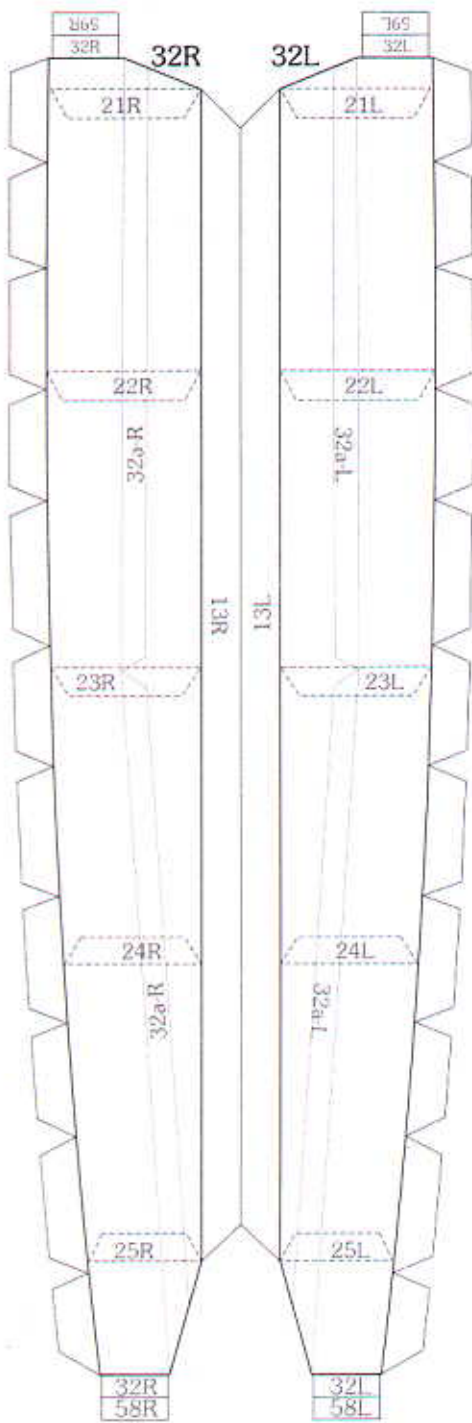

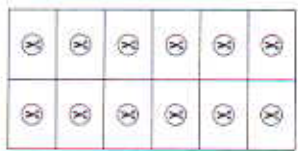

150 Viribus Unitis
arkusz 7



A1 -12

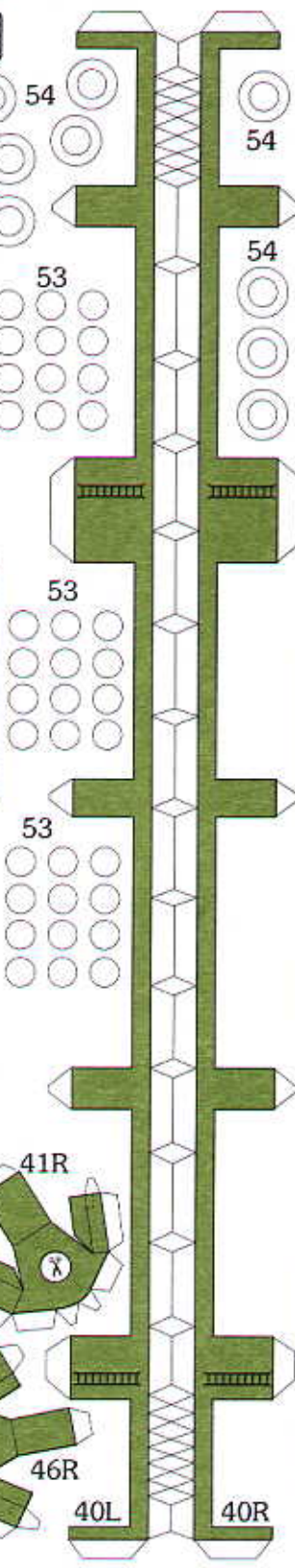
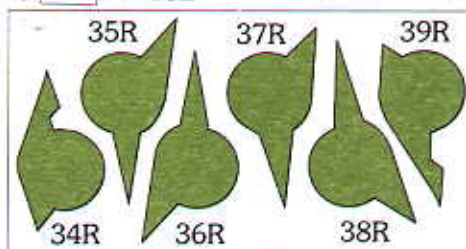
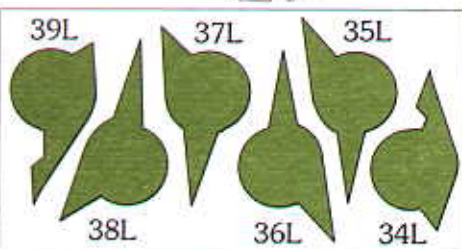
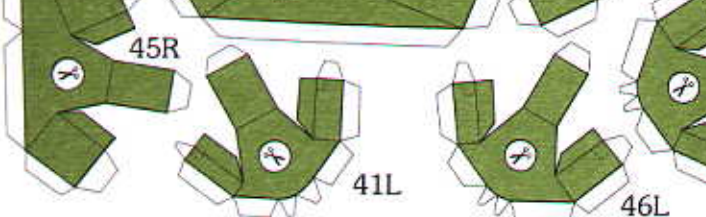
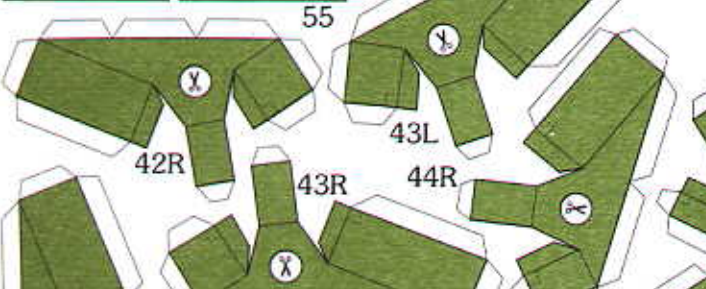
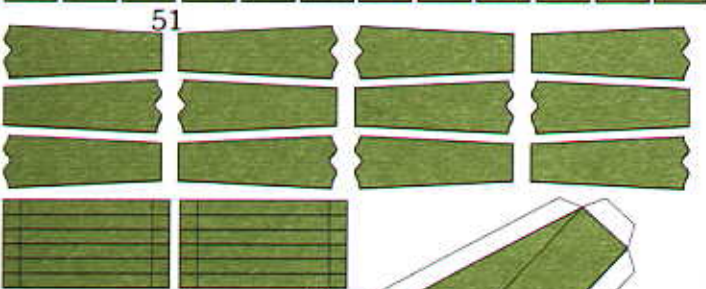
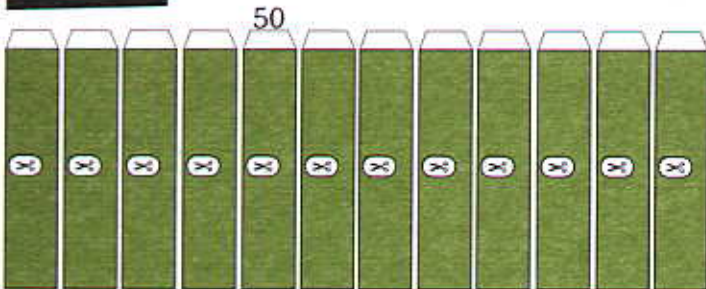

70L

REZERWA

45L



42L



44L



123

114

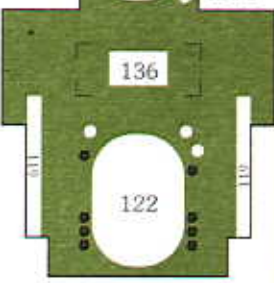

71L

136

122

116

114

115

115

114

114

116

REZERWA

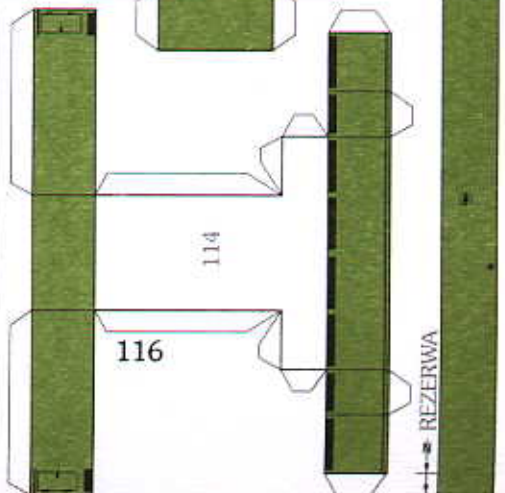

15c Viribus Unitis
arkusz 9



68



62



62



67



67

70R

71R

REZERWA

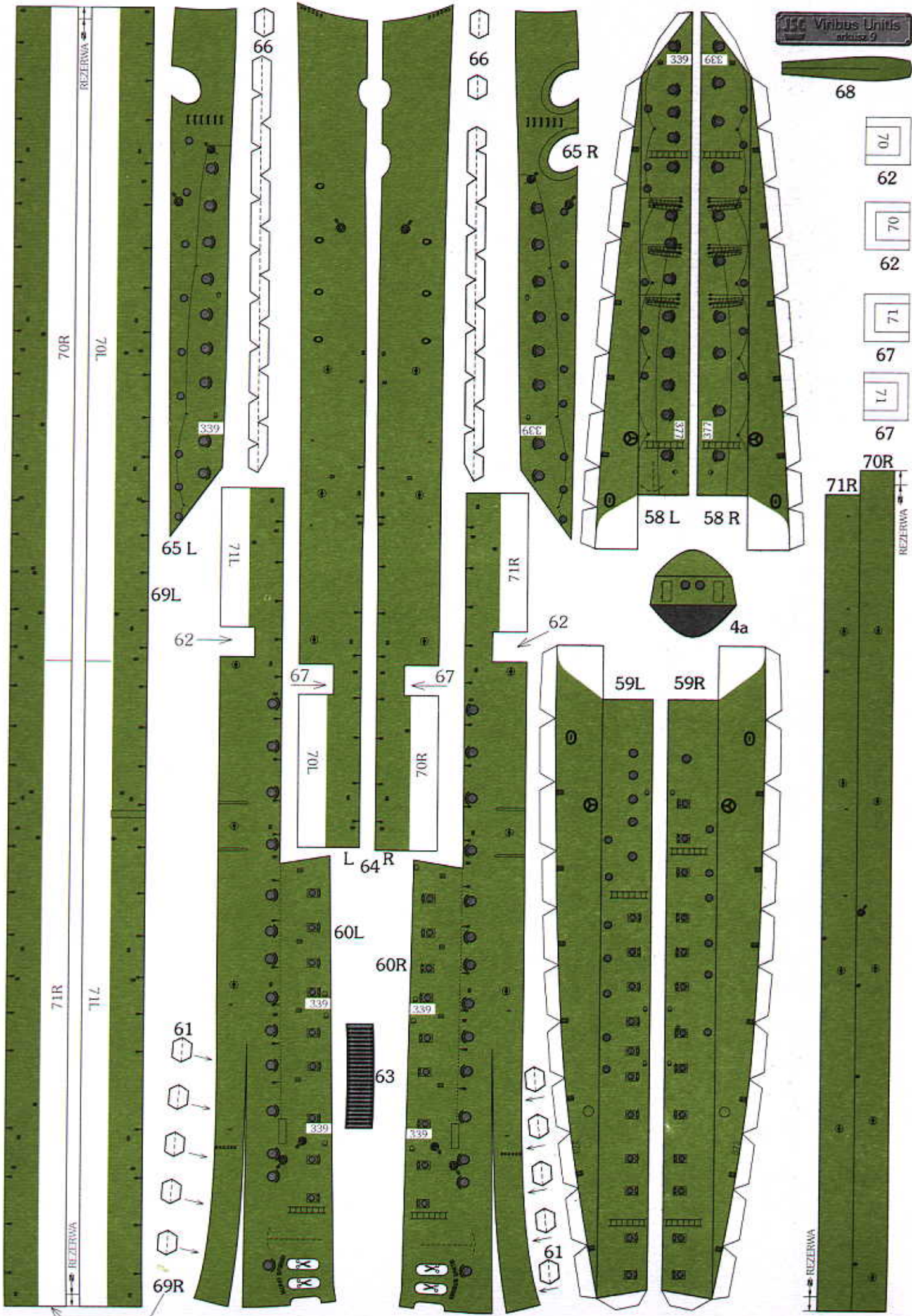

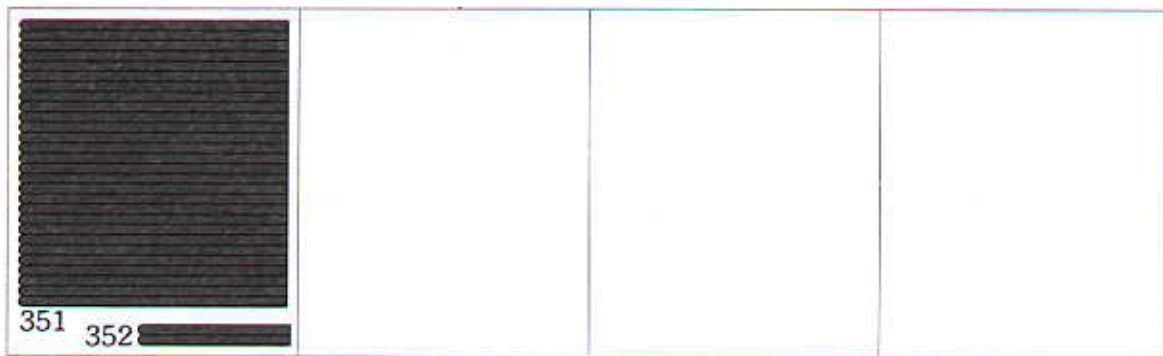
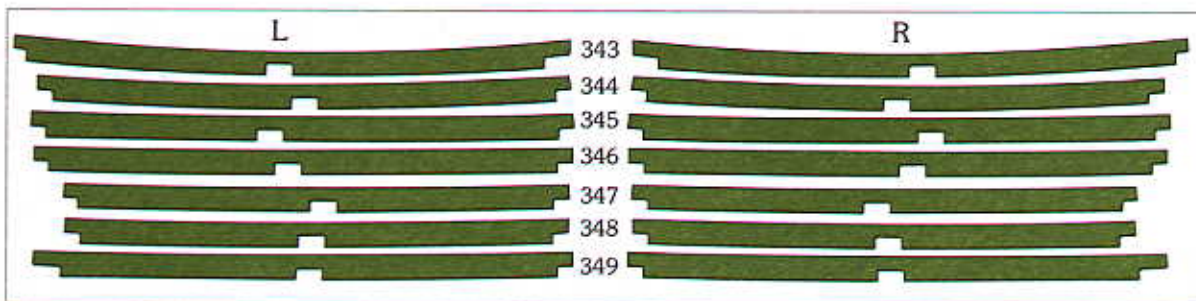

JSC Viribus Unitis arkusz 14

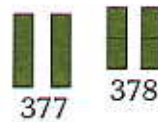

M1 *2



M2 *2



M3



M4 *2



M5 *2



M6 *2



M7



M8



B1 *2



W1 *36



W2 *2



359



365



369



358

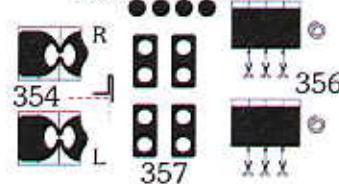

367



366



Viribus Unitis
artus 13

