

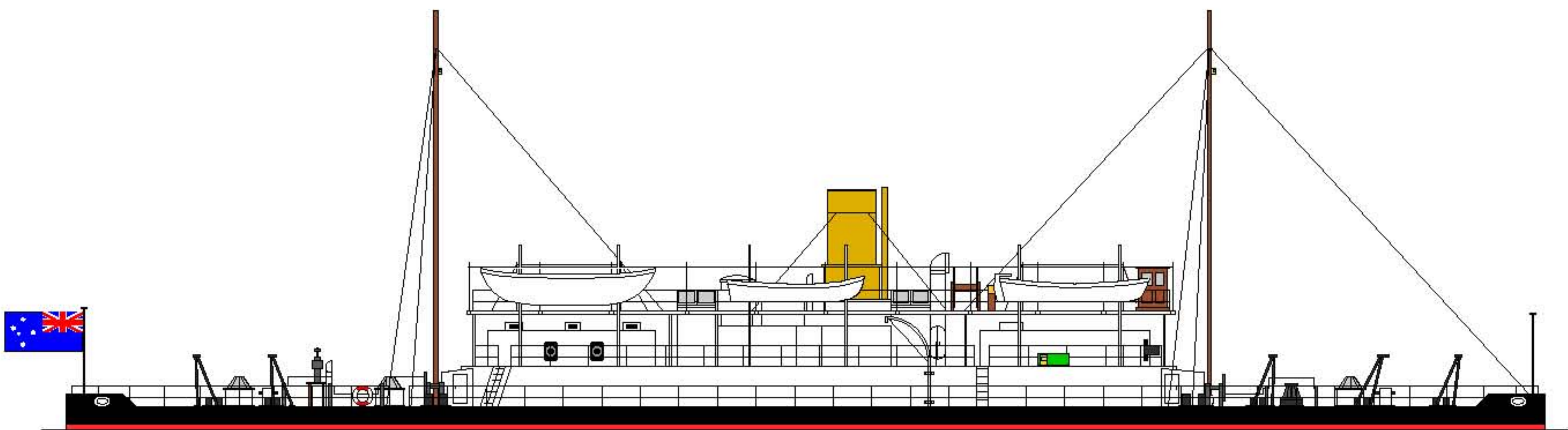

1:250 Scale Precision Card Model

HMVS Cerberus

1870



Length 27cm 562 Pieces 5 A4 Sheets Difficult/Some card modelling experience required

Paper Shipwright. 28 Hayster Drive, Cambridge, CB1 9PB, UK
Email: info@papershipwright.freemove.co.uk

Designed by David Hathaway.

© 2000 Paper Shipwright,
All rights reserved.

HMVS Cerberus

Historical Information

In 1867, the Government of the state of Victoria in Australia ordered a ship to guard Port Phillip Bay. Sir Edward Reed, then Chief Designer of the Royal Navy, set about designing a suitable ship, based on the class of ships known as monitors after the original, USS Monitor. These shallow-draught turret ships were only suitable for rivers or sheltered seaways and Reed made a number of improvements to provide a more seaworthy ship.

First, he designed a breastwork around the superstructure and turrets. This raised the turrets and, as it was heavily armoured, protected the turret bases. The breastwork also improved the sea-keeping of the ship (by raising the vulnerable deck-turret gap) and meant that the main deck did not have to be kept clear of obstructions such as ventilators and raised hatches to provide clear arcs of fire for the main guns.

The two turrets were laid out fore and aft, giving 360-degree coverage and setting a design standard that would endure well past WWII. Reed's HMS Devastation of 1870 is better known as the first fore and aft turret ship, but HMVS Cerberus was both designed and completed ahead of her. Each turret carried a pair of 10" muzzle-loaded, rifled guns (MLR's). A flying deck above the turrets provided a steering position and boat deck.

Cerberus was one of the first warships designed from the outset without sails, relying solely on steam power for propulsion.

Named after the dog that guards the gates of the underworld in Greek mythology, Cerberus was laid down in 1868, launched in 1869, and completed in 1870.

When ready, fitted with a temporary sailing rig and raised bulwarks for the journey, the Cerberus set sail for Australia. En-route she became the first warship to pass through the recently opened Suez Canal. The journey was beset by storms (most of her crew

deserted after a storm in the English Channel) with Cerberus finally arriving in Port Phillip Bay in 1871. She never left.

Cerberus was modified in 1879 to replace the twin pole masts with a single military mast and shortly afterwards to reduce the flying deck and provide a secondary armament of machine guns and small-calibre weapons.

Her military service was unremarkable, never firing her guns in anger. She was renamed twice - to HMAS Cerberus on federation of the Australian States in 1901, and to HMAS Platypus II in 1905 when the name HMAS Cerberus was given to the new RAN shore base.

By the start of WWI she was obsolete and had been laid up on care and maintenance only. During WWI she served as an accommodation ship and then as an ammunition supply ship. After WWI she acted as tender for a short period to the RAN's newly acquired J-class submarines. Cerberus was finally de-commissioned in 1920 and sold for scrap in 1925.

She was sunk as a breakwater in Port Phillip Bay in 1926 - her hulk is easily visible from the shore. Cerberus still has her turrets and main armament, though most fittings (including the engines) have been removed and sold. She has slowly deteriorated and, in spite of a number of attempts at securing funds to raise and restore her, she is probably close to the point where it will no longer be possible to raise her. She was designated a National Monument in 1985.

Cerberus's near-sister ships Magdala and Abyssinia served as guardships at Bombay. Five other similar ships were built for harbour-defense roles in other British colonies. No other vessels of her class survive.

The model shows Cerberus as she appeared in 1870.





Technical Details

Length	:	225'67.5m
Width	:	45'13.5m
Draught	:	15'4.5m
Displacement	:	3,340 tons
Armament	:	4 x 10"/25cm muzzle-loaded, rifled guns in twin Coles turrets.
Propulsion	:	4 x boilers; 2 x Maudslay horizontal engines (250 Nominal HP); 2 x 4-bladed propellers.
Speed	:	9.75 knots (trial speed - not armed or rigged)
Crew	:	82

The model is based on plans provided by Webb Warships.

HMVS Cerberus

Symbols

	Score on printed side and fold away from printed side.
	Score on reverse side and fold towards printed side.
	Cut to the end of the indicated line.
	Cut out area.
27	Part number. Sub-parts are labelled in alphabetic order, eg a,b,c...
27(S)	Simpler version of alternative parts.
27(C)	Complex version of alternative parts.
27*	Part is optional and may be omitted.
16	Glue numbered part here.

Tools required:

- Sharp craft knife.
- Steel ruler.
- Pointed instrument for scoring fold lines (eg a compass point).
- Tweezers for handling small parts.
- Cutting mat, thick cardboard or newspaper to cut on.
- Glue - water-based PVA or clear multi-purpose glue recommended.
- Fine thread for rigging (optional).

General Instructions and Tips

Work in an area with plenty of light and space. Take your time and do not rush.

Read through the instructions and identify all parts before starting.

Score any fold lines before cutting out a part. Use a blunt pointed instrument and a ruler to score fold lines. Note some parts must be scored on the reverse - check the symbols used to indicate the score lines.

Do not cut out any parts until they are required. Cut out any openings in a part before cutting out the part.

Test fit all parts before glueing.

Where parts are contained within a larger, printed rectangle - score, cut out, fold double and glue the whole rectangle. Allow the glue to dry before cutting out the individual parts.

Hatches, doors and other parts are provided both printed in place and as extra parts. The extra parts may be cut out and glued over the printed equivalents to provide a more realistic effect. This should be done before the main part is cut out.

It is recommended to use a flat, stiff piece of wood, plastic or cardboard as a building base during assembly. Glue the hull base to it using a series of small spots of glue around the perimeter. The completed model can be separated from the base by slipping a razor blade between the base and the model.

Glueing a couple of coins inside the model during assembly will help give some mass and stability.

Assembly Instructions

Print out the parts sheets. Sheet 1 should be printed onto 200 gsm card, sheets 2-4 should be printed onto 160 or 170 gsm card and sheet 5 should be printed onto 100-120 gsm paper. Sheets 3R and 5R should be printed on the back of their respective sheets (eg print 2R on the reverse of sheet 2). Ensure the sheets are correctly oriented in the printer feed tray before printing the reverse sides. After printing, spraying the sheets with a clear artist's fixative will prevent smearing and damage from glue stains, but is not necessary if care is taken when handling.

The model has been designed for printing onto A4 sized paper (297 x 210mm). If it is necessary to reduce the sheets to fit another paper size, ensure that the same reduction factor is used on all sheets (this can be easily done during printing using Adobe Acrobat™).

HMVS Cerberus

Assemble parts in number order unless stated otherwise. Where parts have sub-parts, assemble in alphabetic order. Most parts are shown in Figures A - I. Numbers in brackets in the instructions below refer to the part number.

Parts marked with an asterisk (*) are optional and may be omitted if desired.

Some parts have both simple, marked (S), and complex, marked (C), alternatives provided. Study the parts sheets and chose the version according to your skill and ability.

Glue the hull spine (2) and formers (3 - 13) to the hull base (1), aligning them carefully as shown in Figure A. Glue the main deck (14) in position on the hull spine and formers, ensuring it is exactly centred. Glue the breastwork deck (15) in place on the hull spine and formers. Glue the superstructure deck (16) in place. Glue the superstructure sides (17) in place, then the breastwork sides (18,19) and lastly the hull sides (20-23). Carefully glue the bulwark inner sides (24,25) inside at the bows and stern, aligning the openings (cut out the openings in parts 24 and 25 before cutting out these parts). See Figures A and B for details.

Assemble the superstructure pieces as shown in Figure B & C. Parts 28 and 31 should be rolled and glued to form cylinders.

Assemble the turrets (34) as shown in Figure B. The gun barrels if fitted should be rolled and glued to form cylinders and the corresponding openings should be cut out in the turret sides (34h) before cutting out the turret sides. If required, fit the gratings (34f) by cutting out the corresponding shapes in the turret roof (34g) and glueing the gratings below the turret roof.

Glue the flying deck supports (38) in place on the main deck. Fold double and glue the flying deck, allow to dry and cut out. If the awning stanchions (91) are not being fitted, the small square protrusions on the flying deck may be cut off. Glue the lifeboat derrick brackets (40,41) to the underside of the flying deck and then glue the flying deck in place on the superstructure and supports - ensure the supports and superstructure match with their locating marks on the underside of the flying deck. You may wish to fit the supports after the flying deck is in place.

Assemble the funnel (42), conning tower (43), boiler intake (44), vents (46,48), chart-house (62) and companionway hatches (45,47). Glue in place on the flying deck when dry. If the flying deck railings (88) and awning stanchions (91), or alternatives, are to be fitted, glue them in place before the lifeboat derricks are fitted.

Glue other fittings in place on the main deck, breastwork deck and flying decks as shown in Figures C, D, E and F.

Assemble the lifeboat (68), gigs (69) and dinghy (70). Cut out, shape and glue the hull sides. Add any stern-pieces. If desired, glue in the floors and cut out the corresponding areas in the decks/seats. Glue the decks/seats in place and add any other fittings. Cut off the triangular piece at the bows. Hang the lifeboats from the derricks using the paper tackle provided or short lengths of thread. If breastwork deck railings (89), or alternatives, are to be fitted they should be glued in place before the lifeboats are glued in place.

The supplied anchor chains (76,77) may be fitted or replaced with real miniature chain available in good hobby shops. Fit the anchor gallows and tackle, then assemble the anchors (75,76) and glue them to the anchor gallows tackle as shown in Figure H. The anchor should rest on the edge of the deck. Note that a tackle should be attached to each end of the anchors, both where the arms meet the shaft and at the other (shackle) end. The chain should be glued to the shackle end of the anchors.

The masts (81,82) can be rolled from the printed parts provided. Rolling around and glueing a piece wire inside will provide some additional stiffness. Alternatively, suitable wooden or plastic masts may be fitted. The masthead lights should be glued to the masts as shown in Figure I.

The navigation lights (83,84) should be glued to the tabs on the breastwork sides outboard of the railings as shown in Figure D.

If railings are fitted, glue 2 lifebelts (86) to the railings at the front of the flying deck, 2 to the railings at the rear of the flying deck and two to the main-deck railings near gap in the railings at the stern. If railings are not fitted, omit the lifebelts or glue them to the breastwork sides.

Railings (88-90) are supplied and can be fitted if desired. Fold each piece and glue in place as indicated in Figure G. The paper railings supplied can be replaced with railings made of thread or wire. Photo-etched metal parts (available in good hobby shops) may also be used.

The model can be rigged using fine thread or nylon fishing line. Refer to Figure I for a rigging diagram.

The flags should be folded and glued double. The Union Jack (87b) should be glued to the bow flagpole and the State of Victoria flag (87a) should be glued to the stern flagpole.

Assemble the name badge (92).

The model is now complete.

HMVS Cerberus

List of Parts

No.	Description	Sheet	Diagram	No.	Description	Sheet	Diagram
1	Hull Base	1	A	54	Hawsepipe	5	E *
2	Hull spine	1	A	55	9 inch pump	3	E,F A
3 - 13	Hull formers	1	A	56	Compass platform	3	F *
14	Main deck	1	B	57	Compass binnacle	5	D,F *
15	Breastwork deck	1	B	58	Main deck air vent	5	F A
16	Superstructure/deck	2	B	59	Breastwork deck steps	5	D
17	Superstructure/sides	2	B	60	Wheel	3	D
18,19	Breastwork sides	2	B	61	Telegraph	3	D *
20 - 23	Hull sides	4	B	62	Chart house	3	D
24	Bow bulwarks - inner	4	B	63	Breastwork deck ladder	5	D *
25	Stern bulwarks - inner	4	B	64	Derrick	3	D
26	Funnel trunking - lower	2	C	65	Derrick bracket	3	D *
27	Conning tower - lower	2	C	66	Lifeboat davits - large	3	D
28	Boiler intake trunking	2	C	67	Lifeboat davits - small	3	D
29	Fore companionway shaft	2	C	68	28 foot lifeboat	4	I
30	Deck ventilator	3	C *	69	25 foot gig	4	I
31	Air vent - lower	2	C	70	16 foot dinghy	4	I
32	Stern companionway shaft	2	C	71	Flagpole - fore	4	I *
33	Locker	5	C *	72	Flagpole - aft	4	I *
34	10 inch gun turret	2	B,C	73	Anchor gallows	4	E,F
35	Officers heads (toilets)	3	C	74	Anchor	4	E
36	Crew heads (toilets)	3	C	75	Sheet anchor	4	F
37	Breastwork deck air vent	5	C A	76	Anchor chain - port	4	E *
38	Flying deck support	2	D	77	Anchor chain - stbd	4	E *
39	Flying deck	2	D	78	Bollard (double)	5	E,F *
40	Davit bracket - short	2	D	79	Bollard (single)	5	E *
41	Davit bracket - long	2	D	80	Towing Bollard	5	E,F *
42	Funnel	3	D	81	Foremast	5	I
43	Conning tower	3	D	82	Mainmast	5	I
44	Boiler intake	3	D	83	Navigation light - port	5	D *
45	Companionway (stern)	3	D	84	Navigation light - stbd	5	D *
46	Air vent - upper	3	D A	85	Masthead light	5	I *
47	Companionway (fore)	3	D	86	Lifebelt	4	- *
48	Flying deck air vent	5	D A	87	Flags	5	I *
49	Skylight	5	E, F	88	Flying deck railings	5	H *
50	Capstan	3	E *	89	Breastwork deck railings	5	H *
51	Capstan roller	3	E *	90	Main deck railings	5	H *
52	Stopper	5	E *	91	Awning stanchions	4	J *
53	Bitt	5	E,F *	92	Name plate	4	- *

* = Optional part A = simple and complex alternative parts supplied.

List of Figures

- A Hull base & formers (plan)
- B Hull, sides, breastwork, superstructure (plan and elevation)
- C Breastwork and superstructure (plan and elevation)
- D Flying deck and supports (plan and elevation)
- E Bows (plan and elevation)
- F Stern (plan and elevation)
- G Misc part construction details
- H Railings, lifeboats, anchors (plan)
- I Masts, flagpoles, rigging (plan and elevation)
- J Flying deck awning support rigging
- K Pump handles

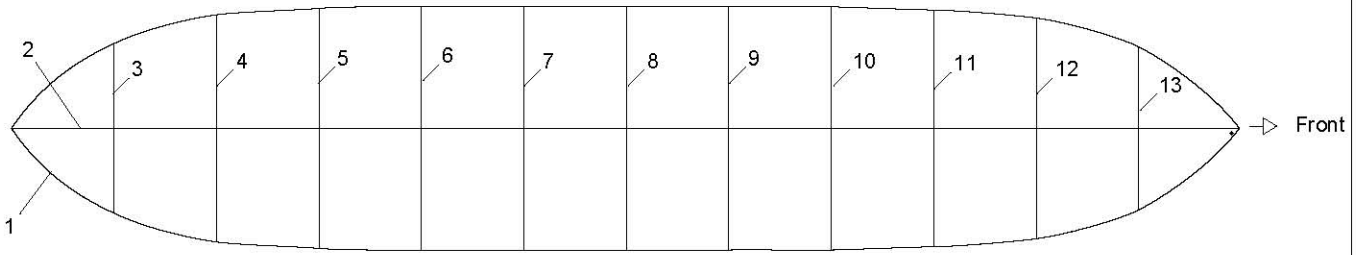
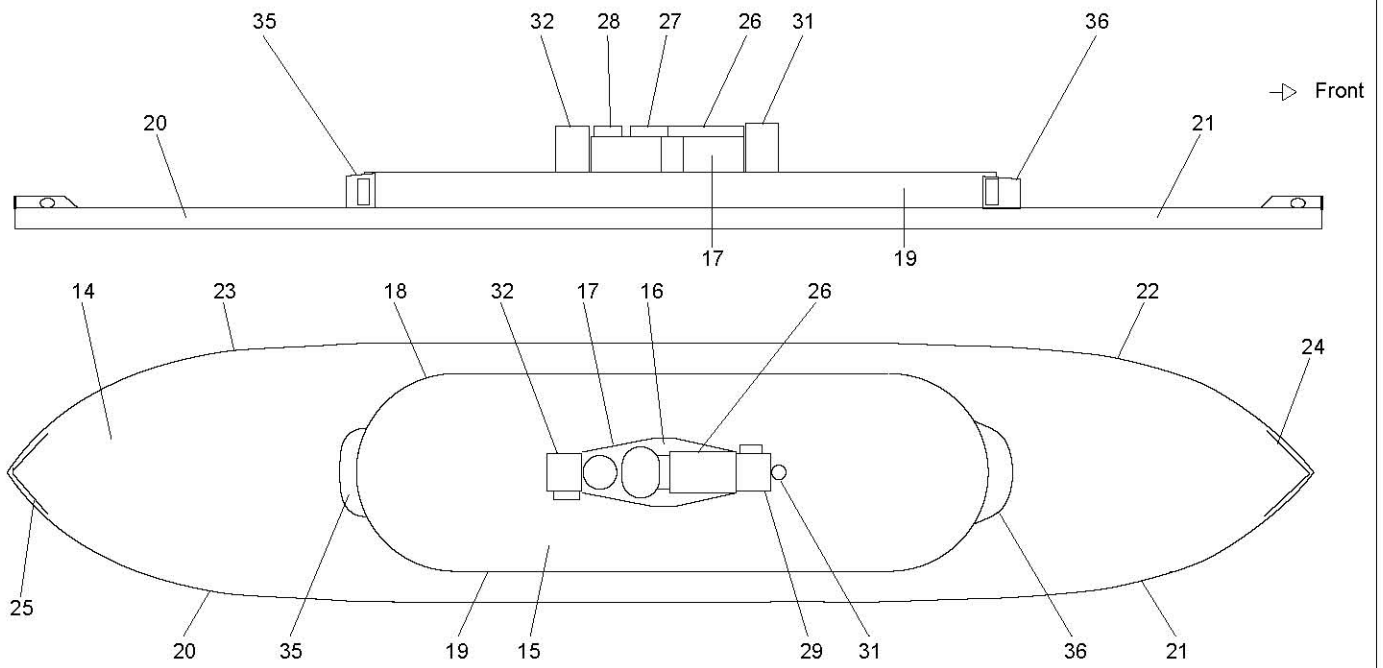
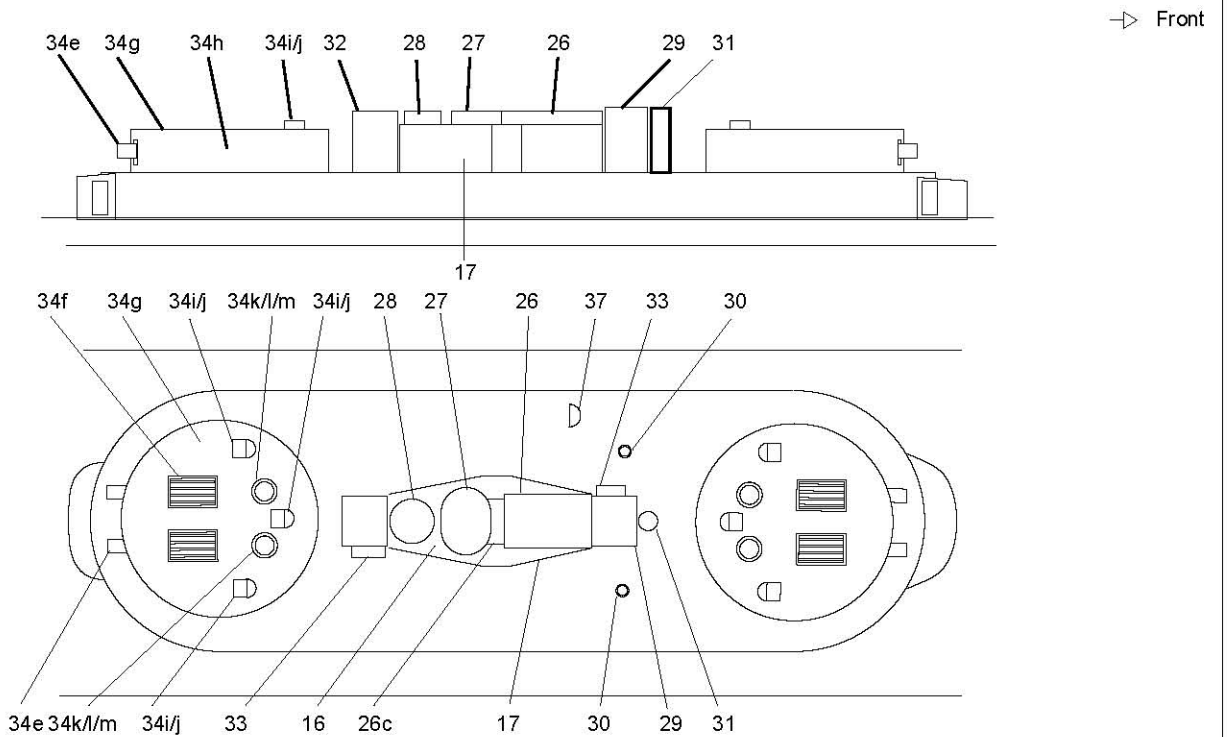
A**B****C**

D

→ Front

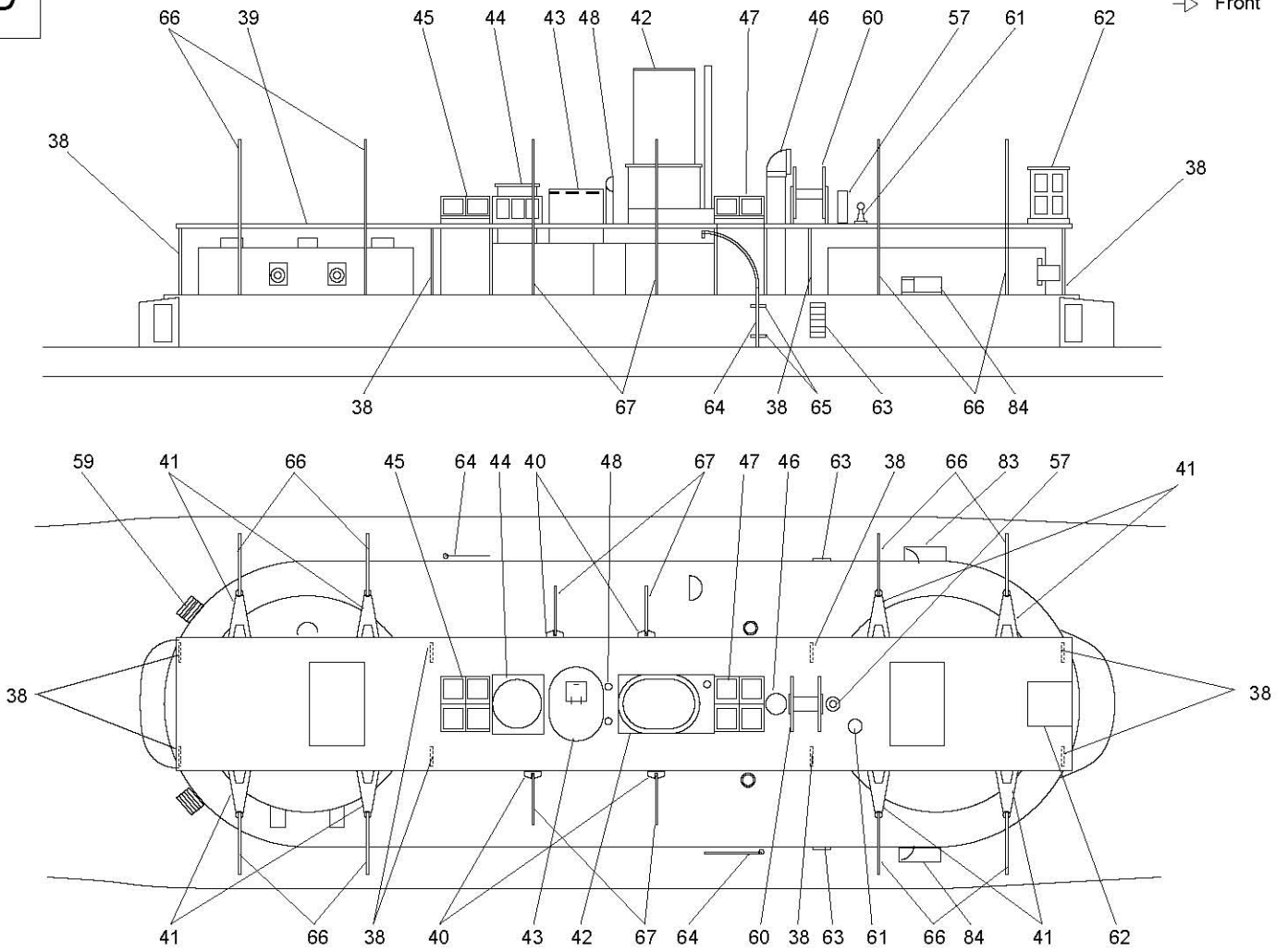

E

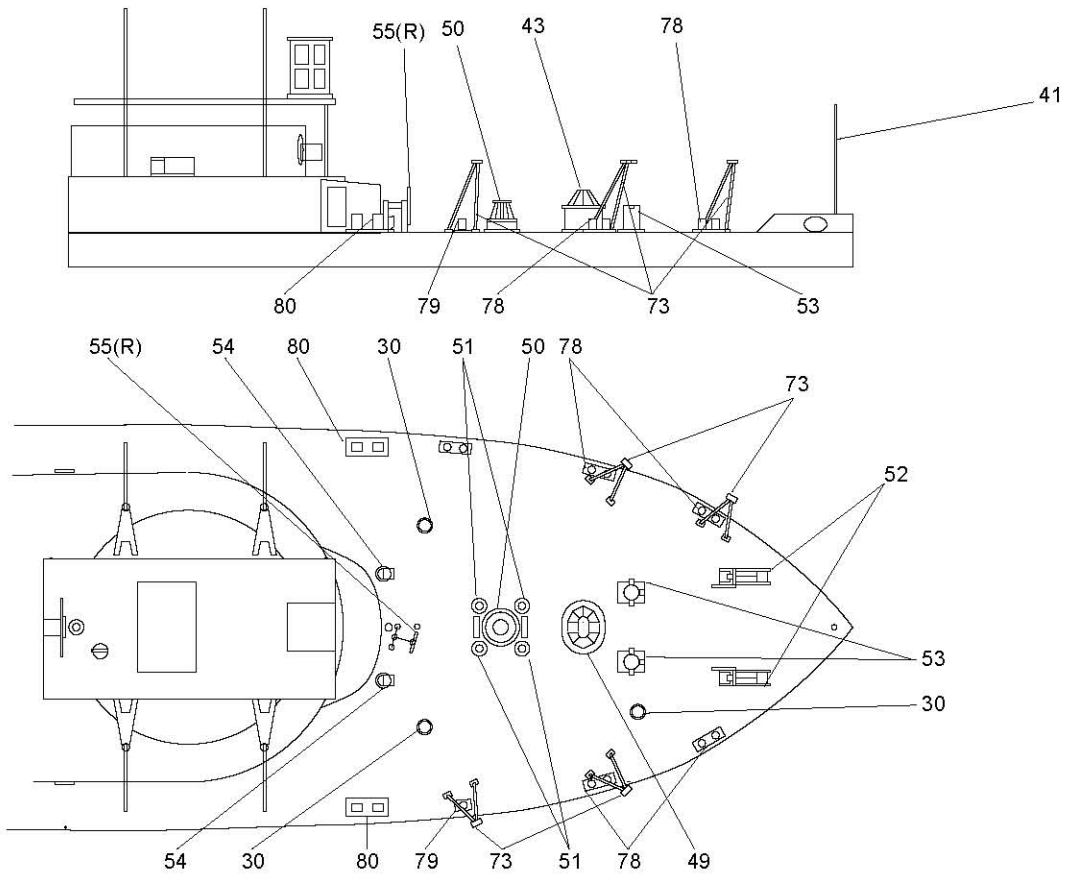

F

→ Front

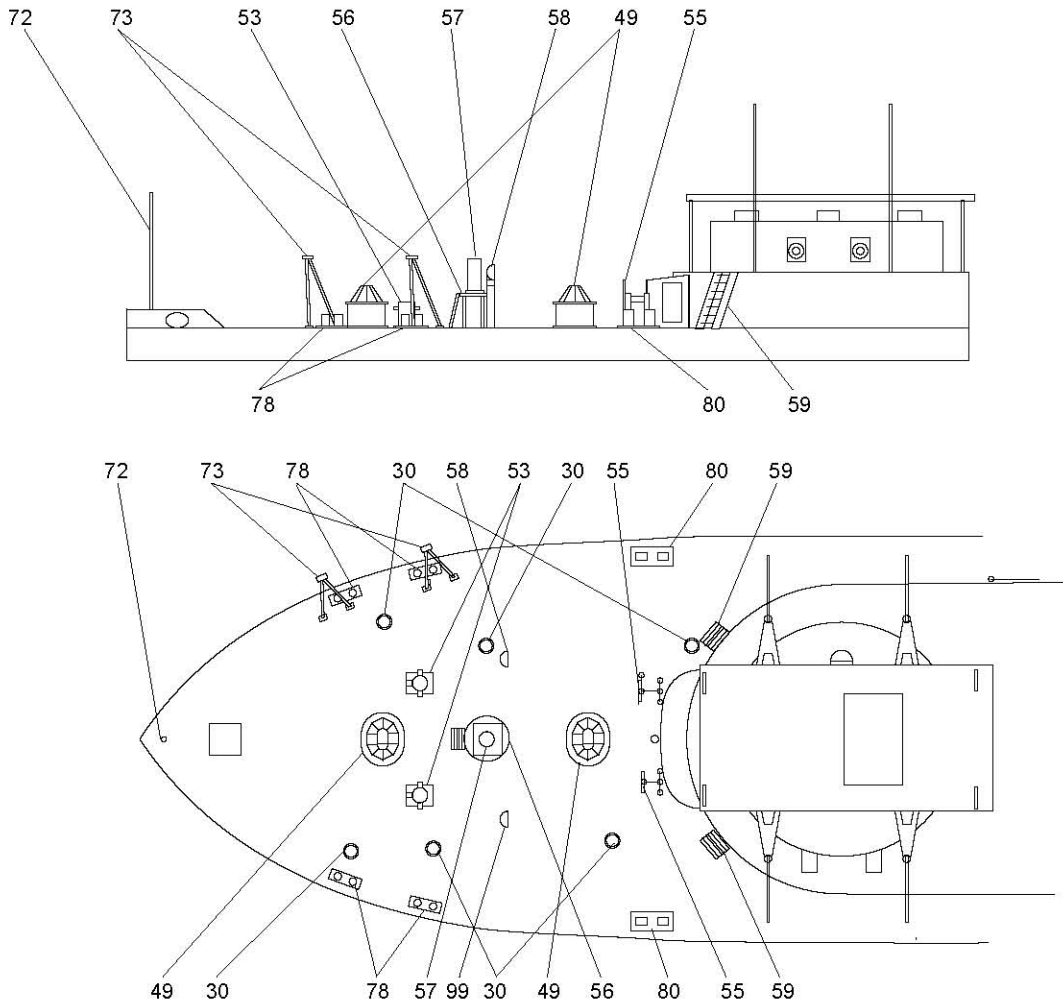

G

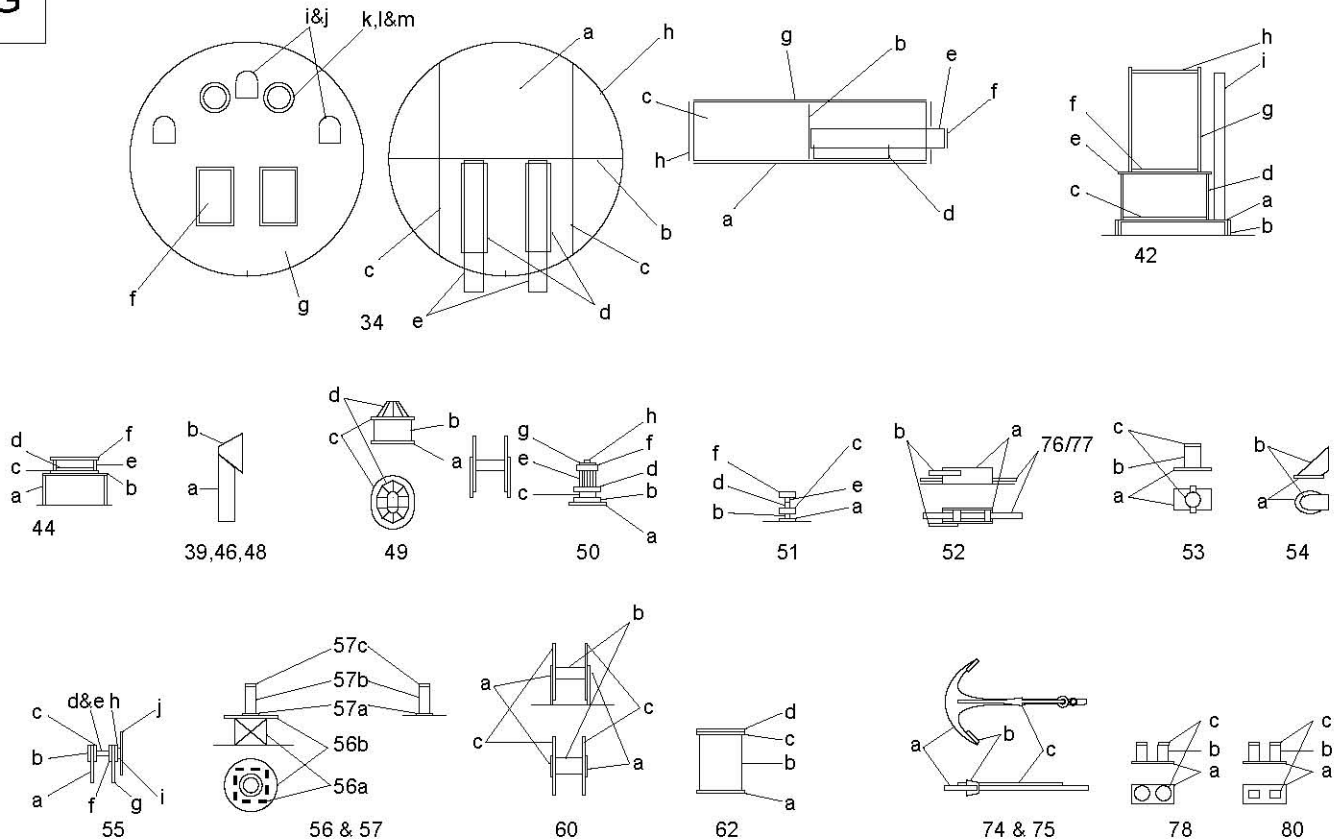

H

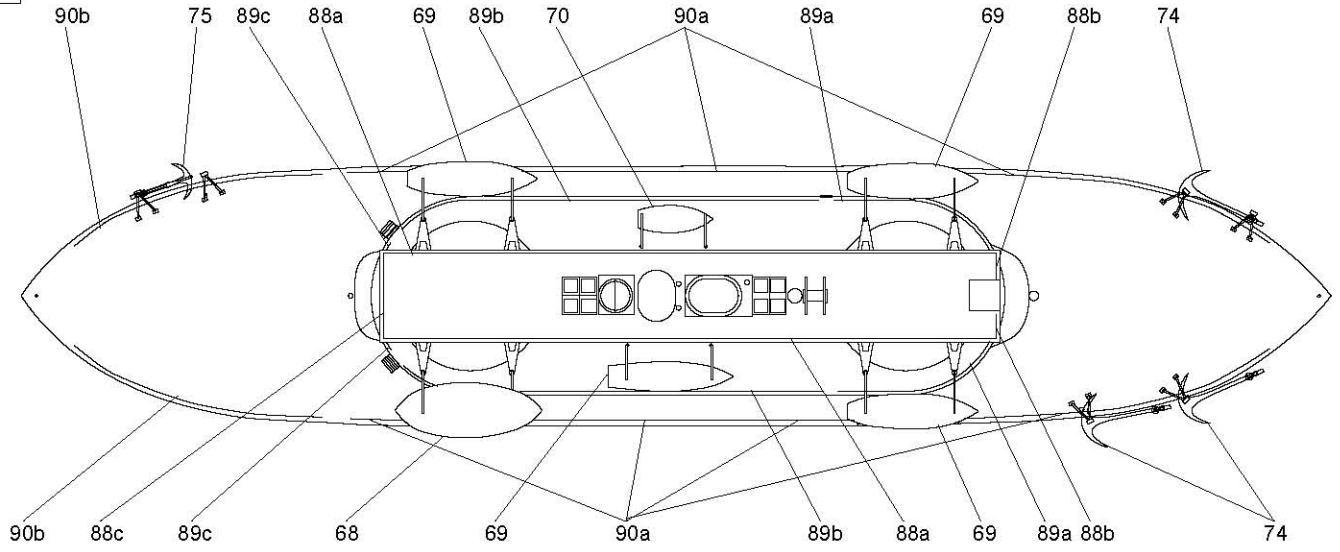

I

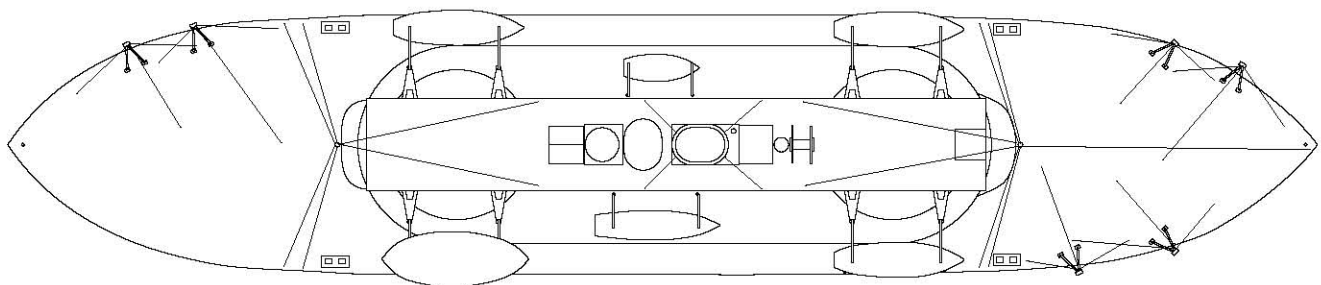
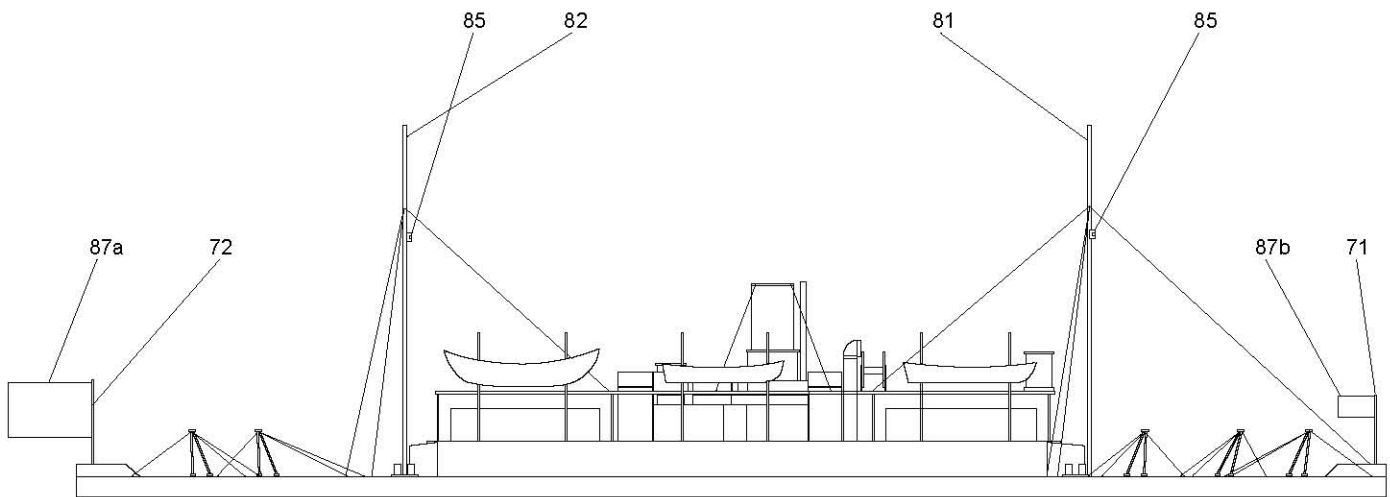

J

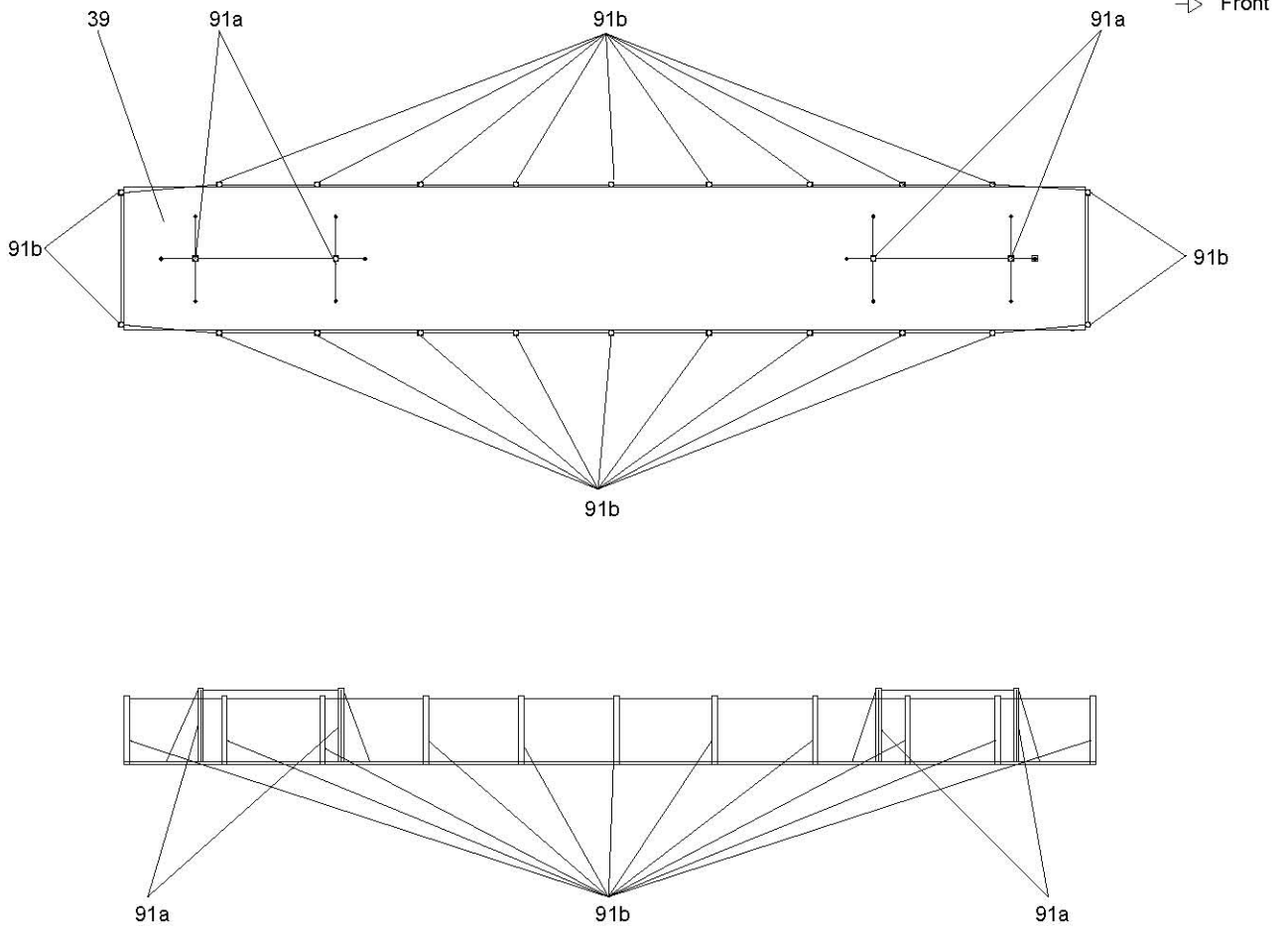

K

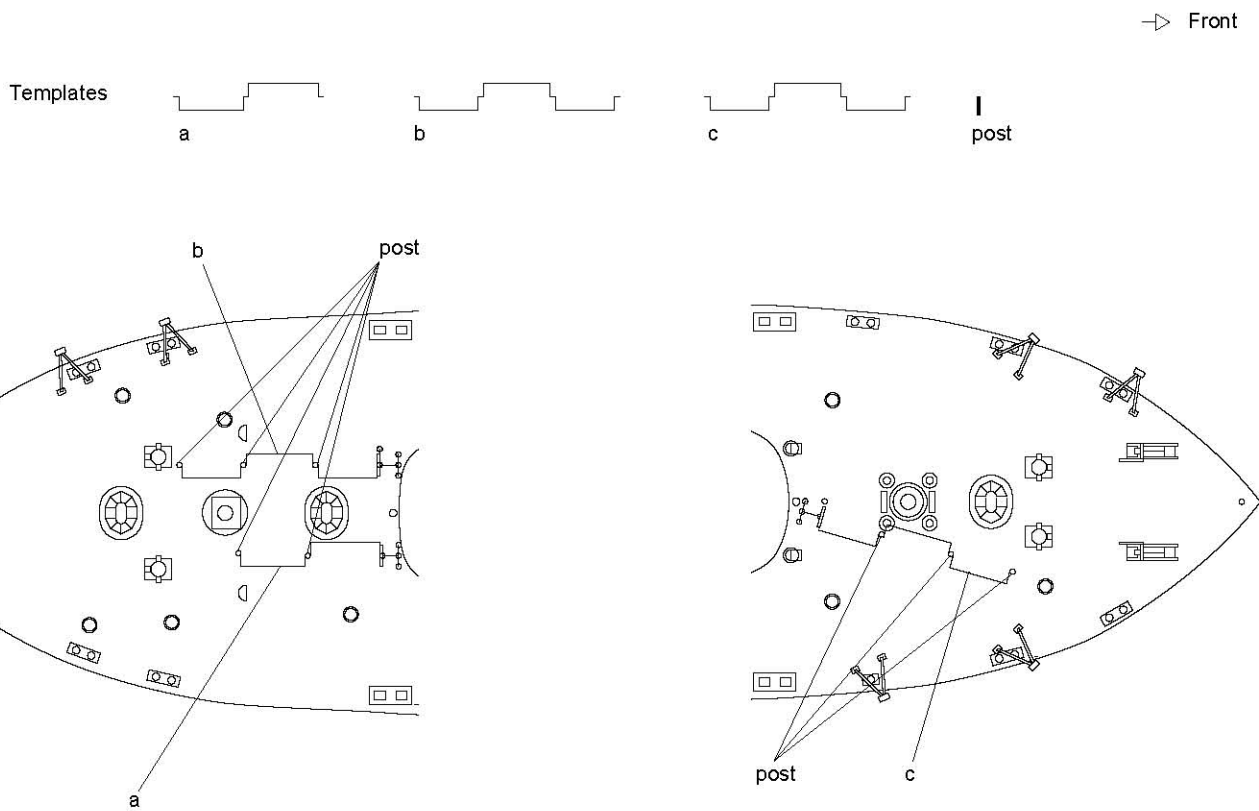

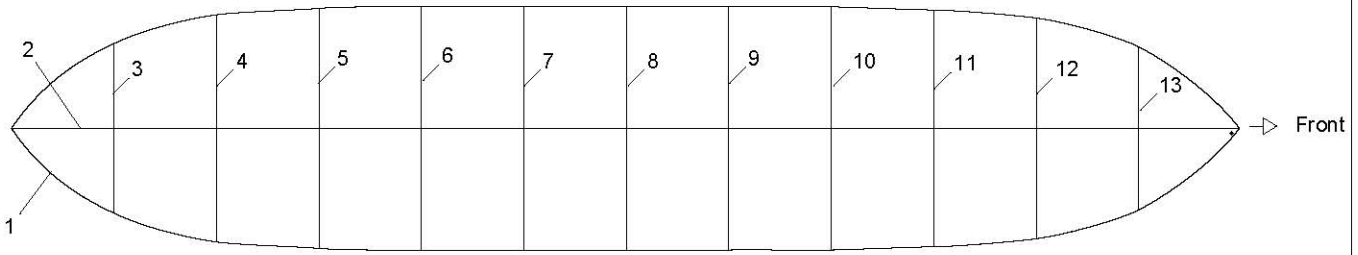
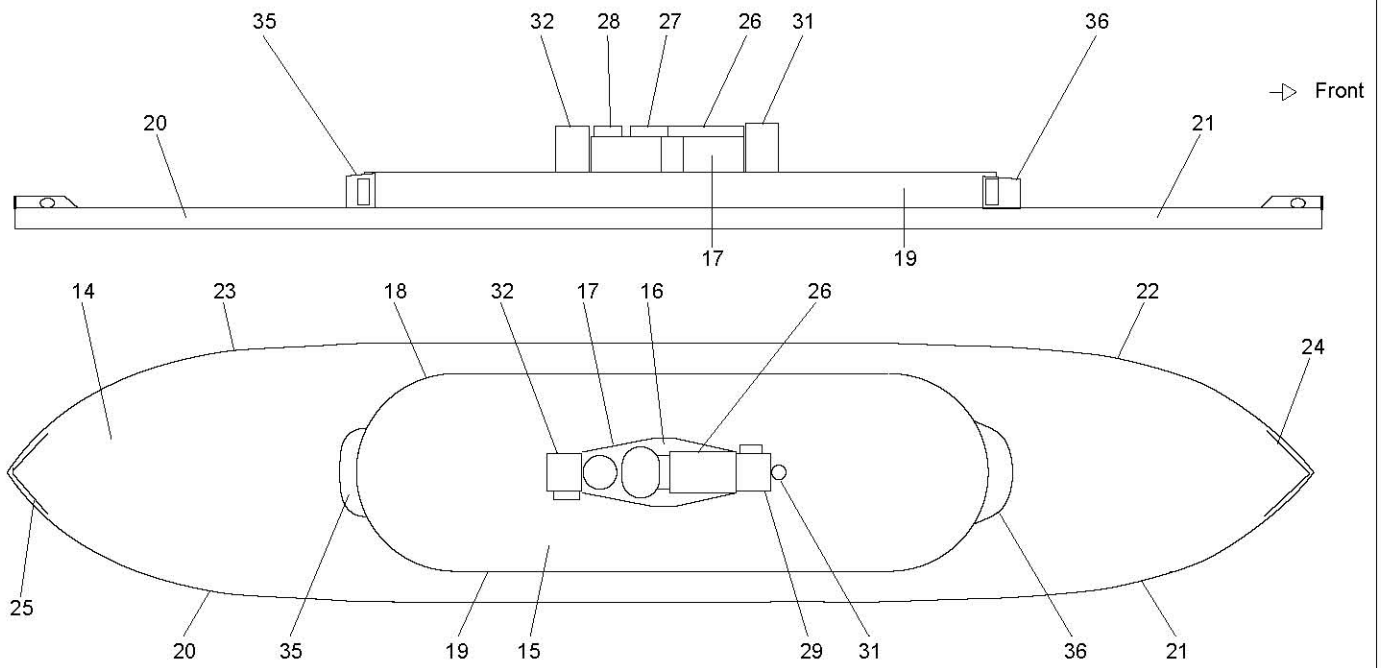
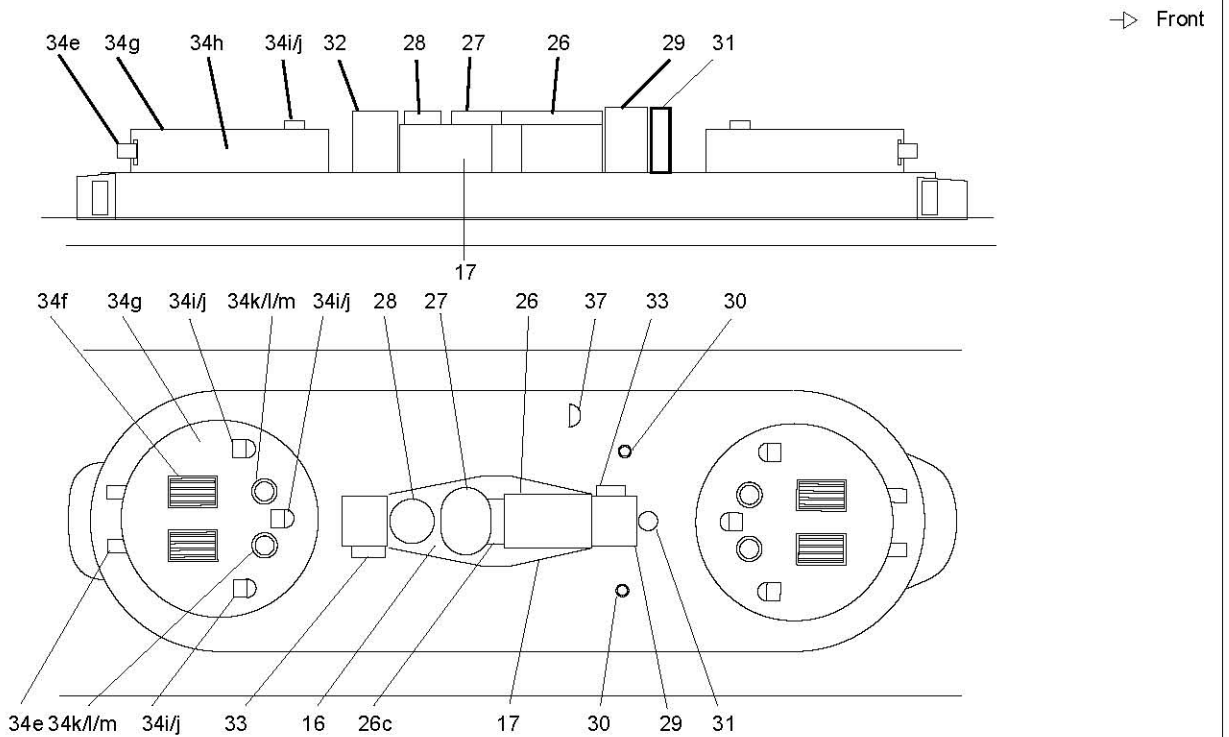
A**B****C**

D

→ Front

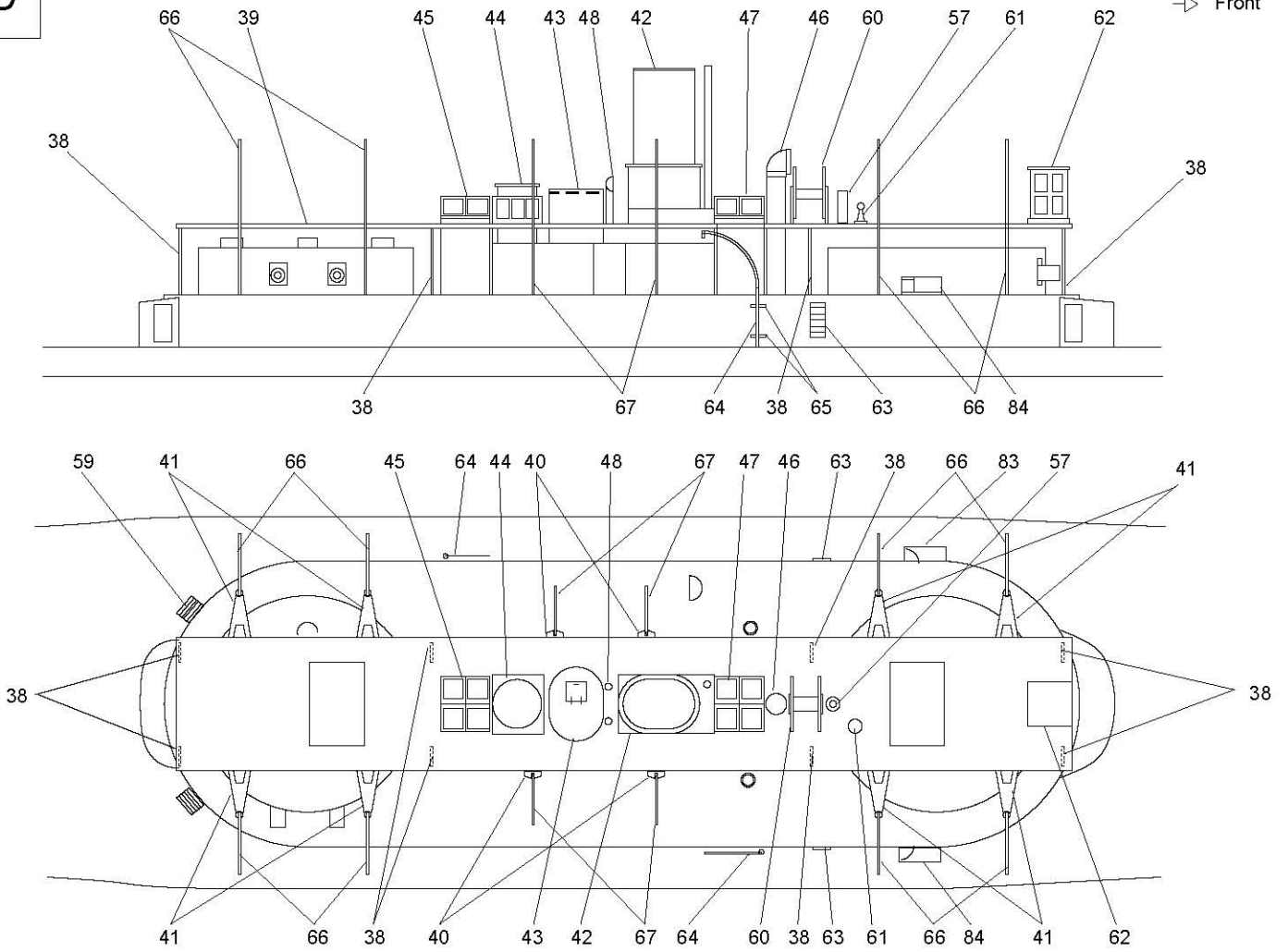

E

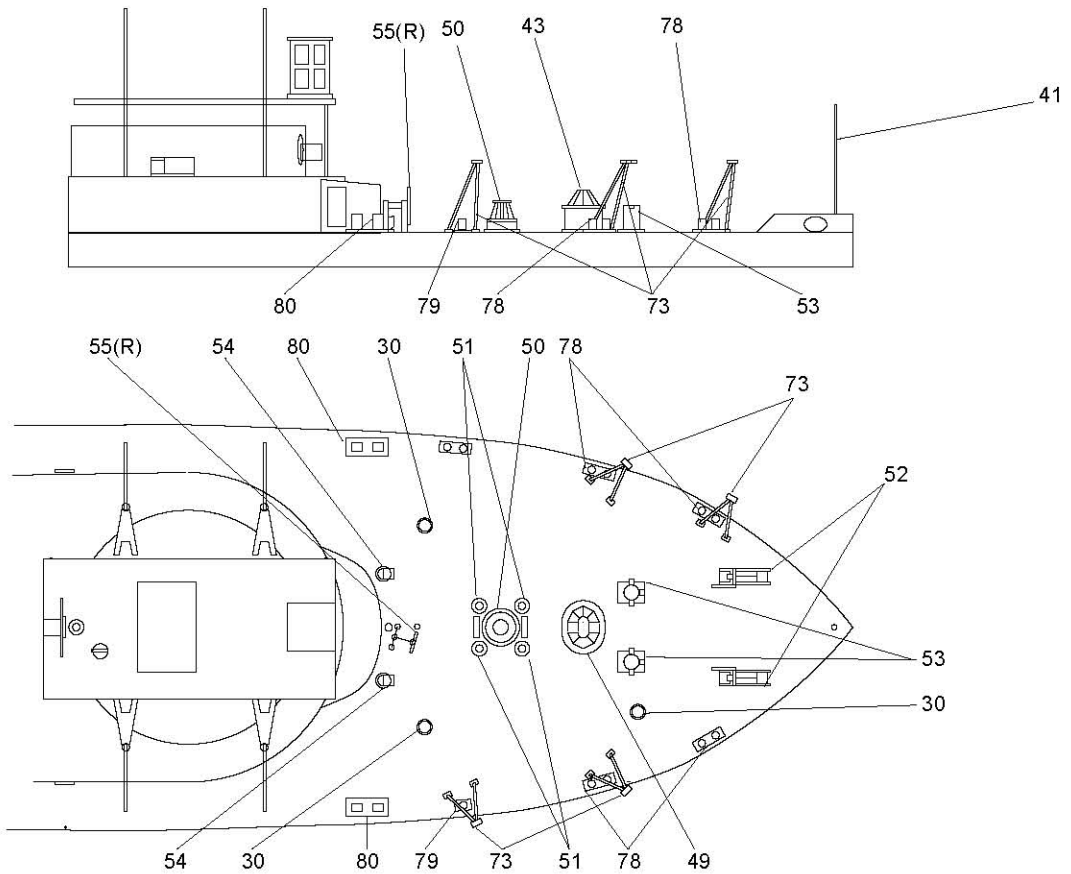

F

→ Front

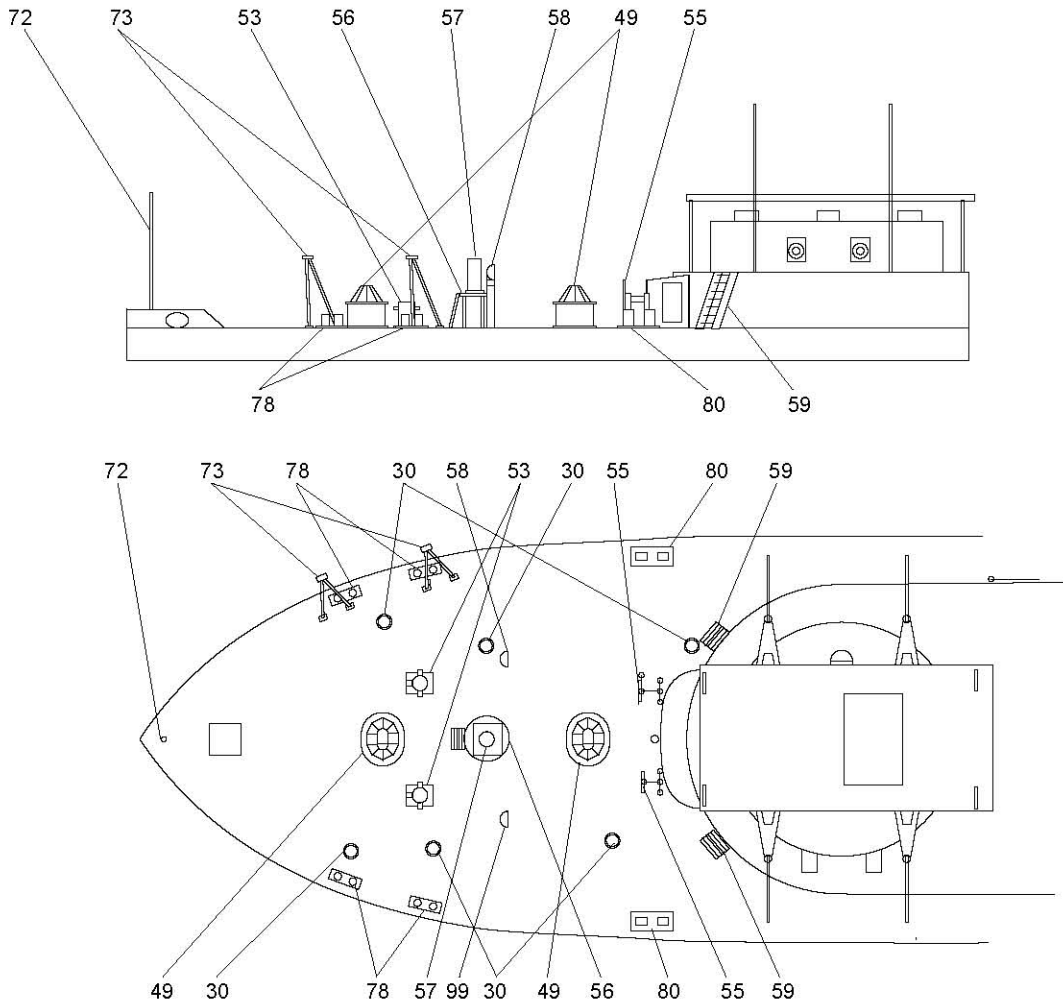

G

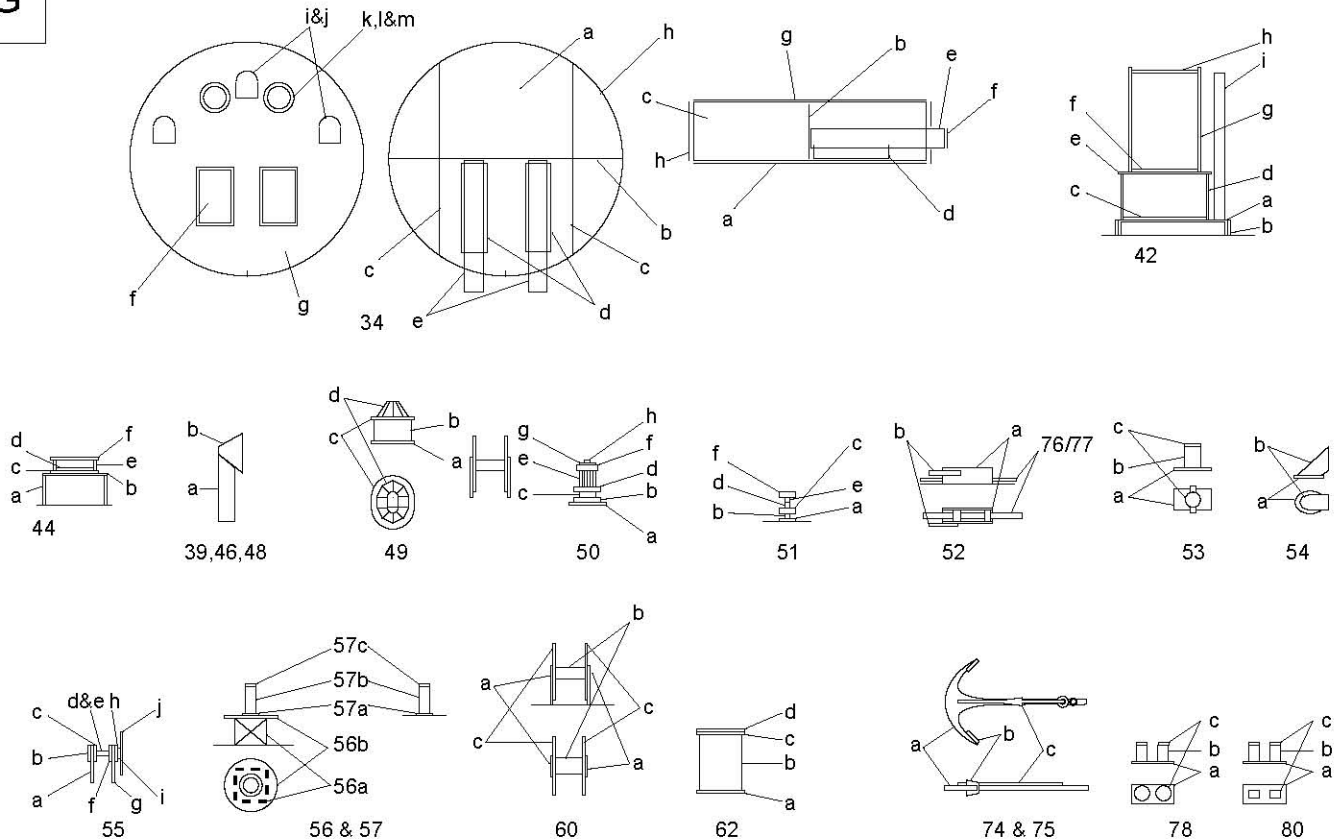

H

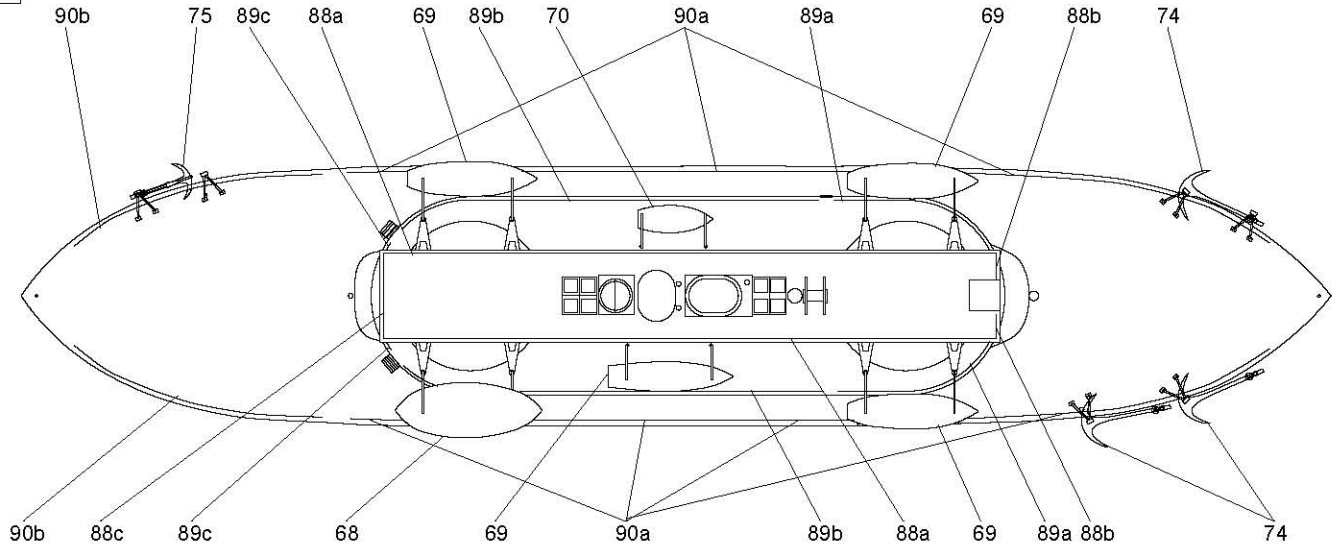

I

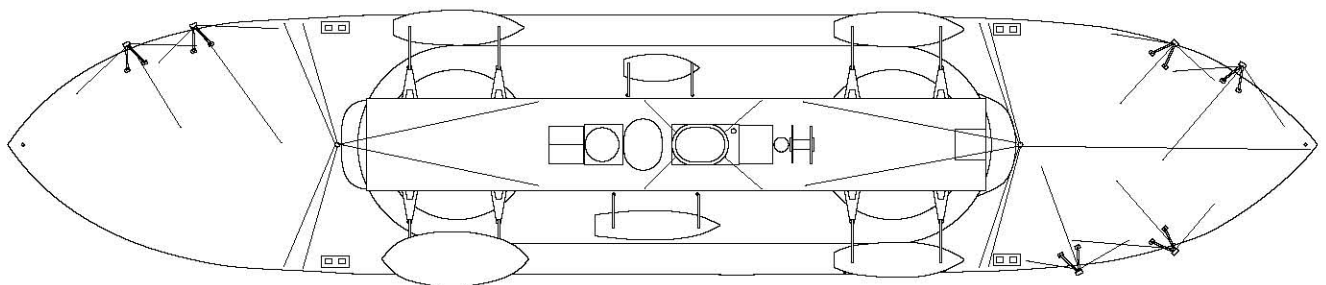
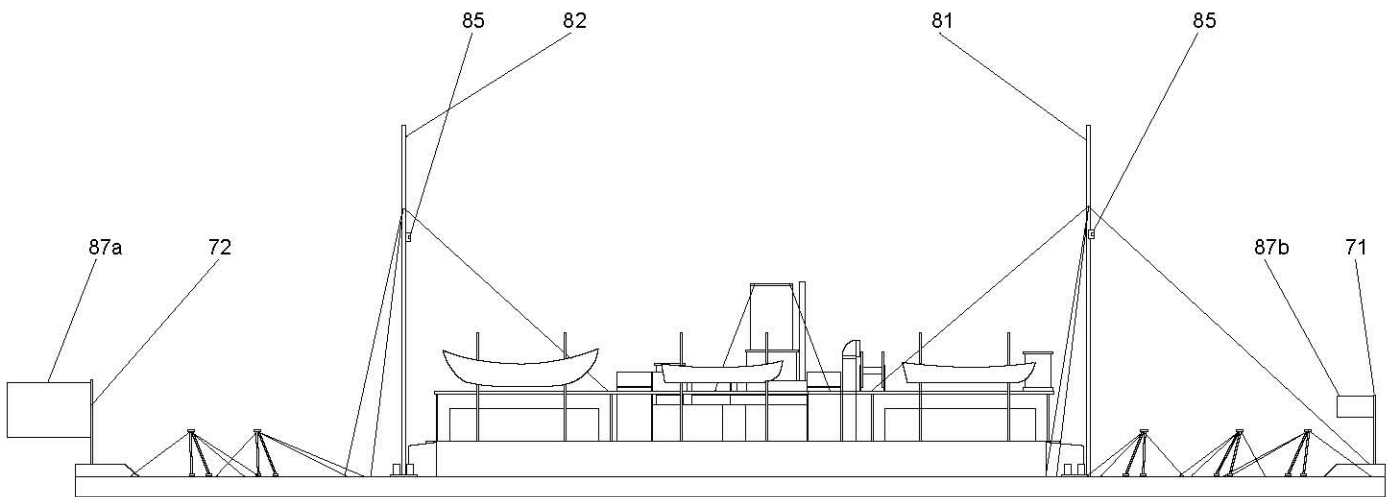

J

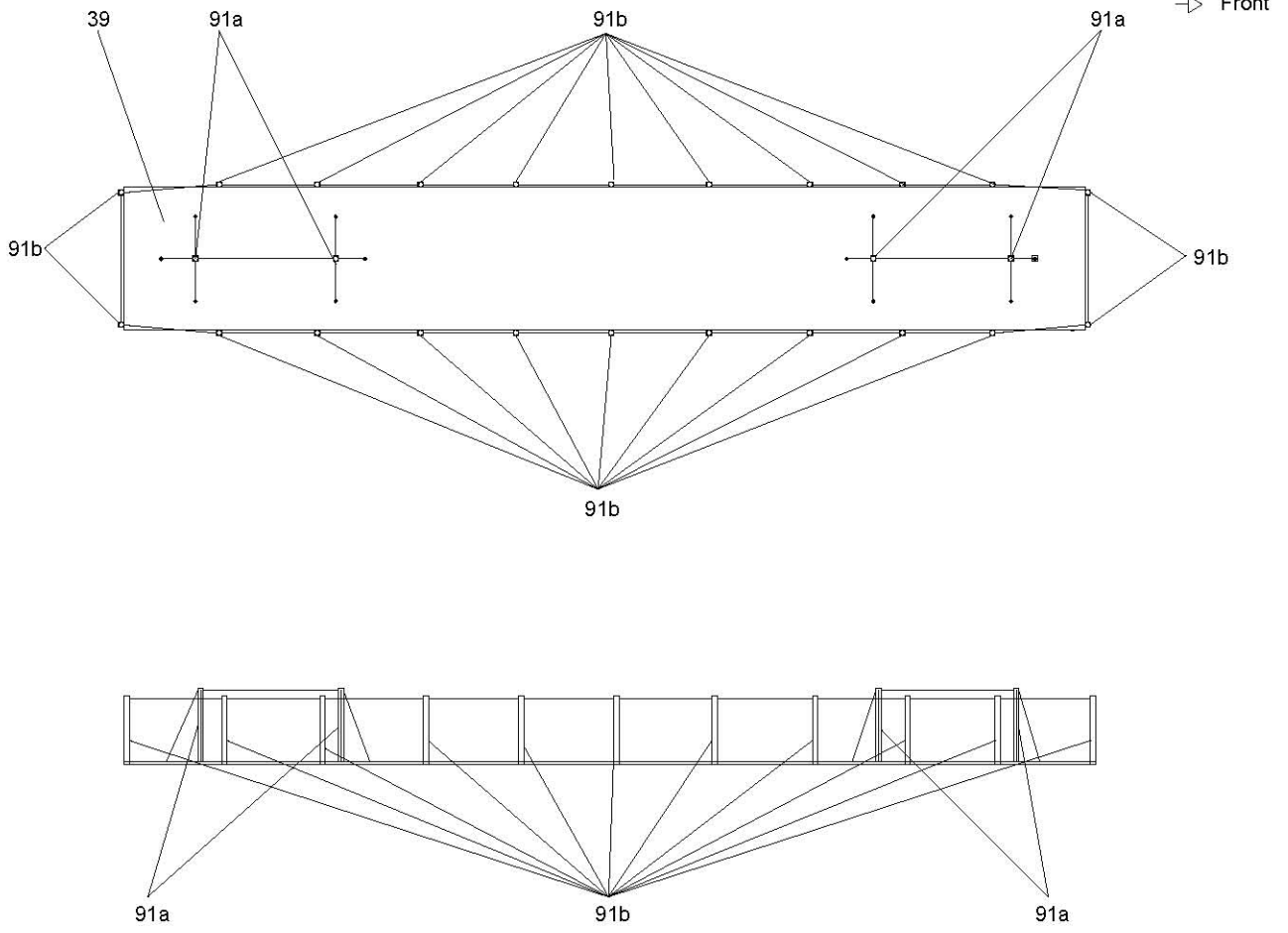

K

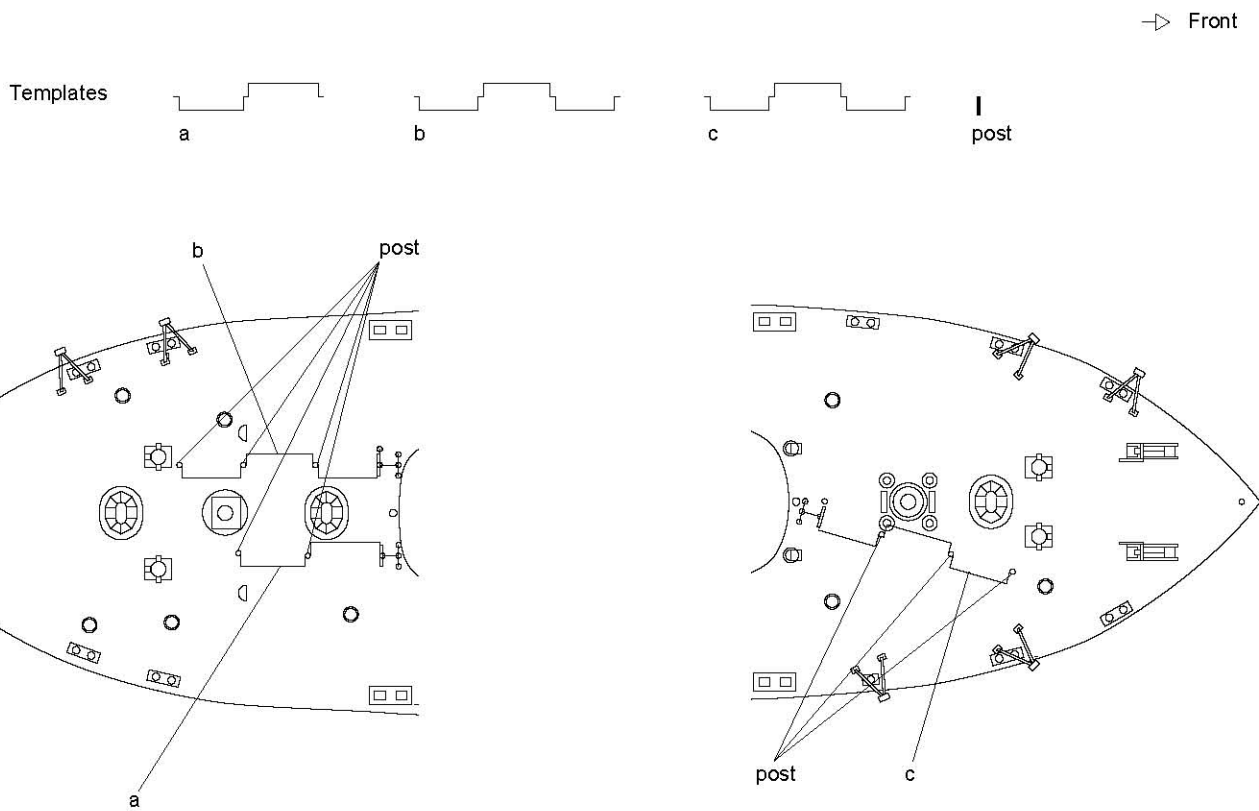

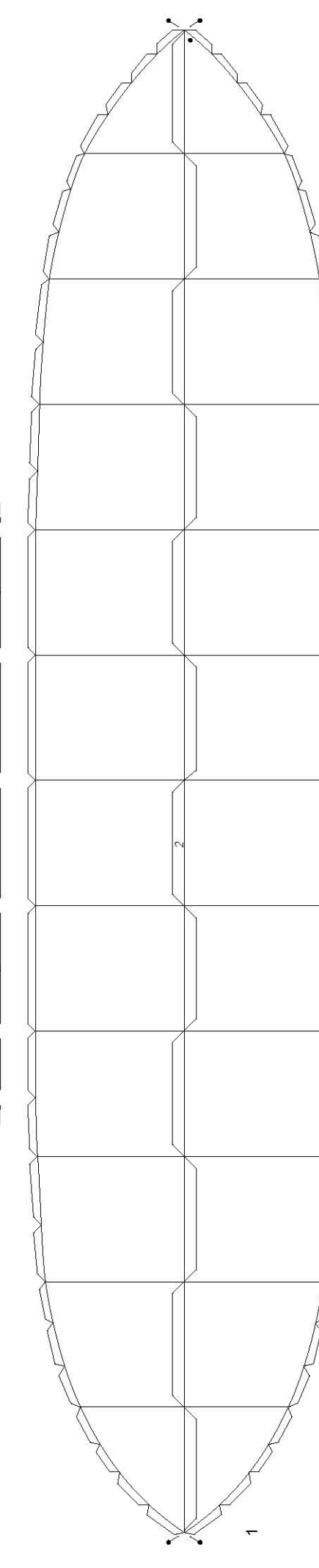
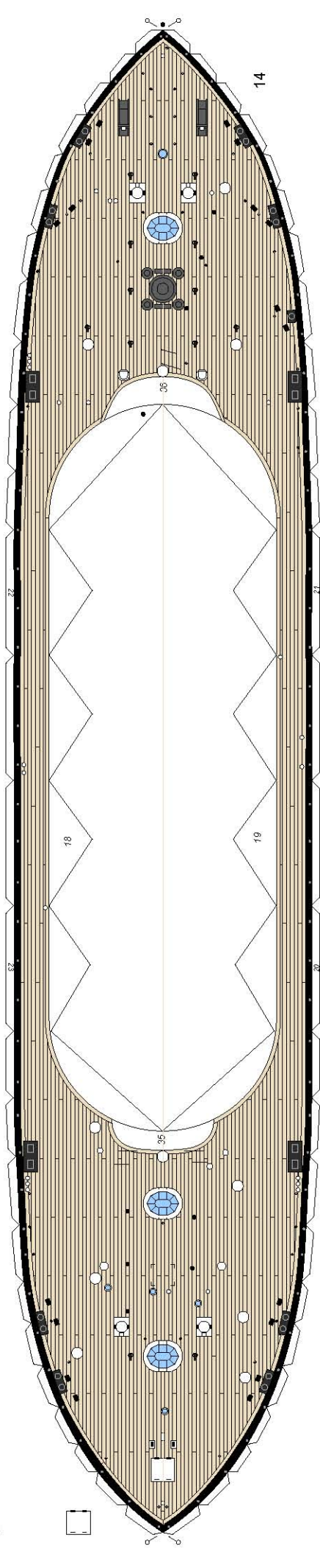
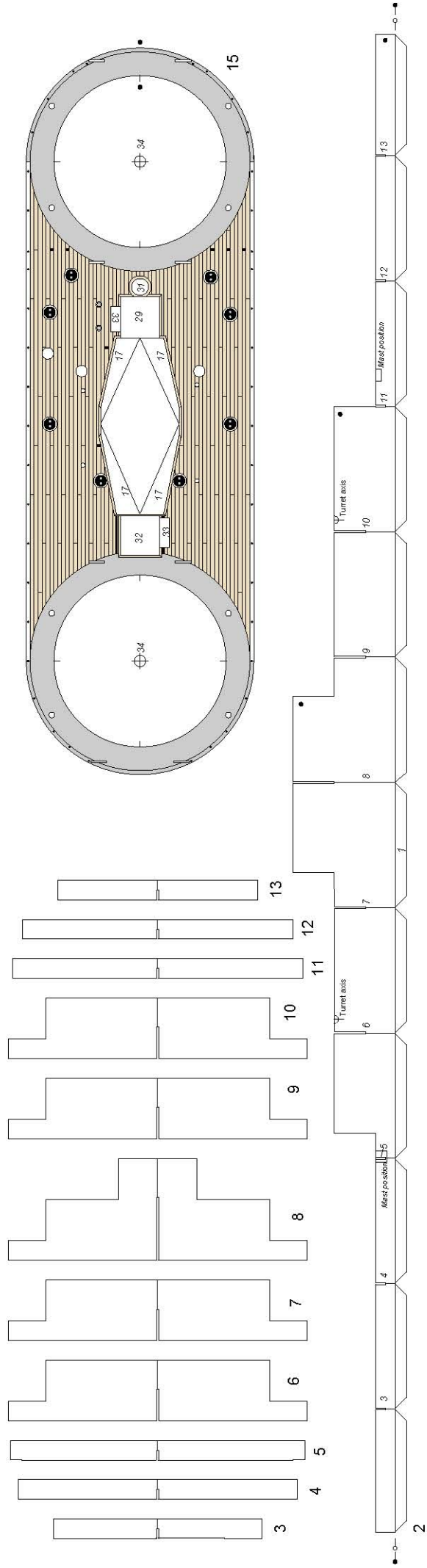

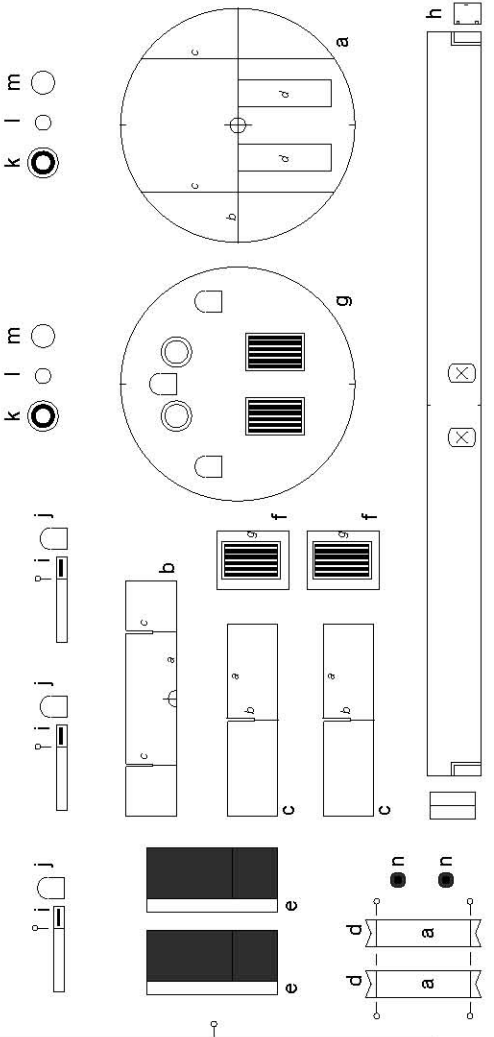
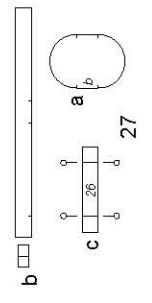
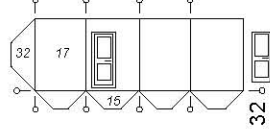
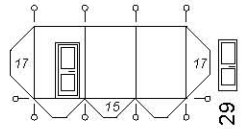
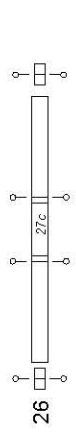
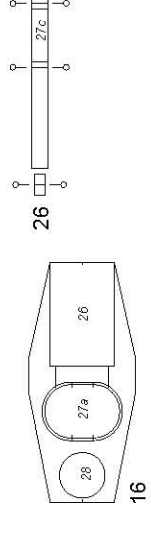
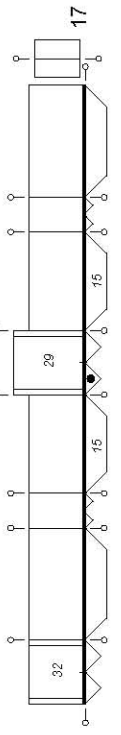
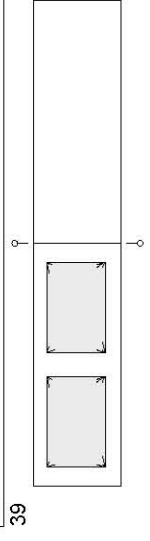
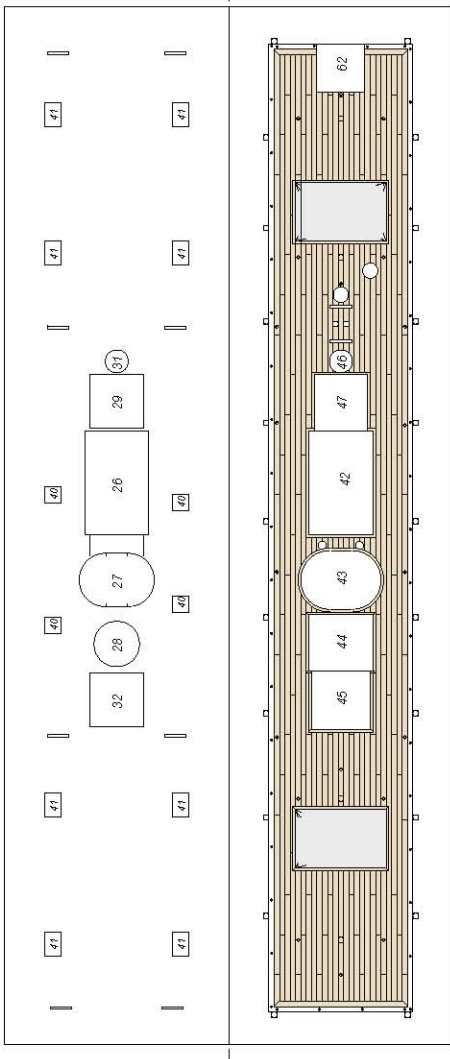

34

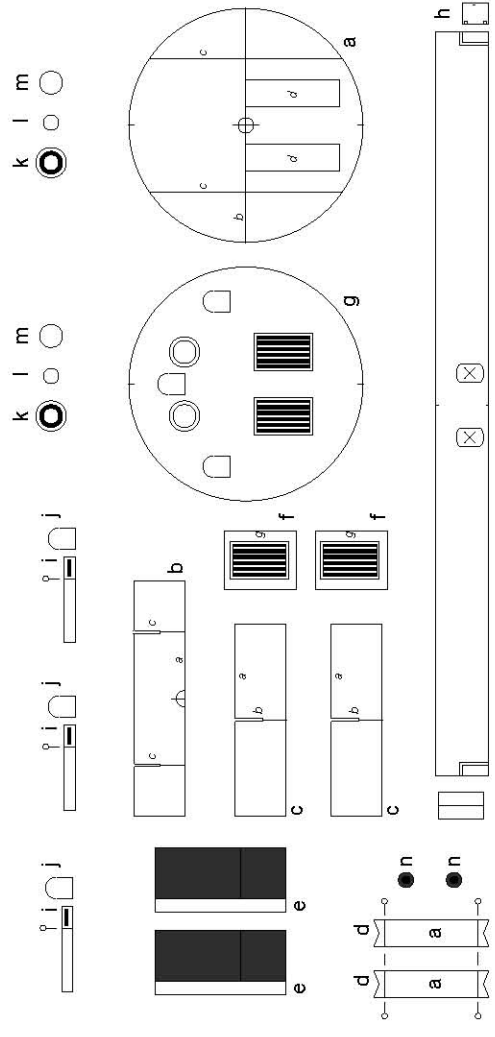

34

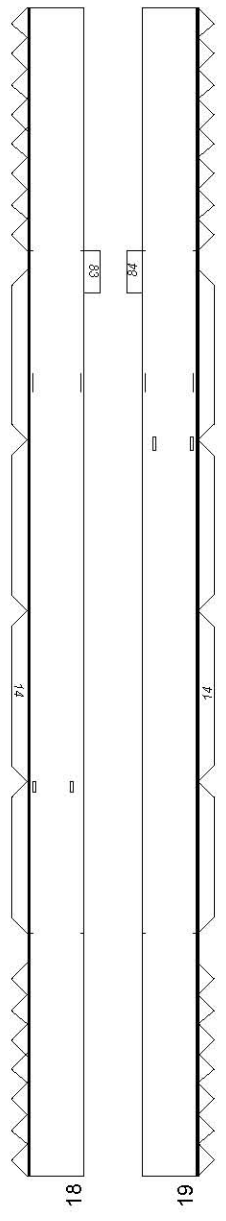
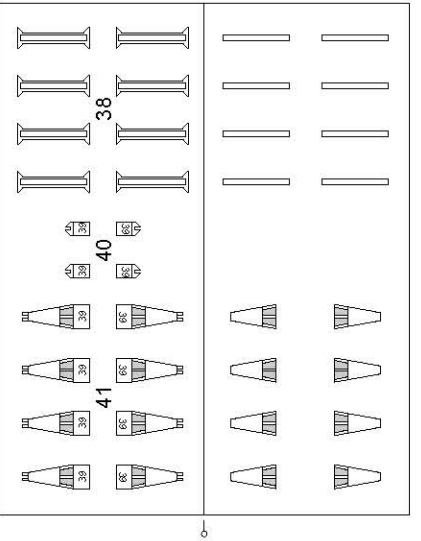

18

19

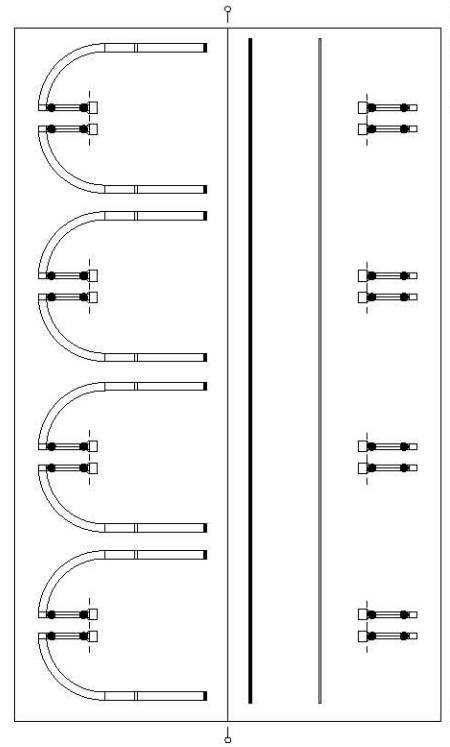
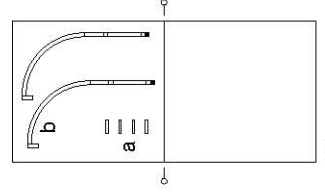
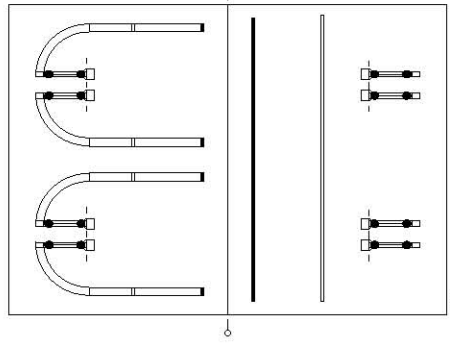
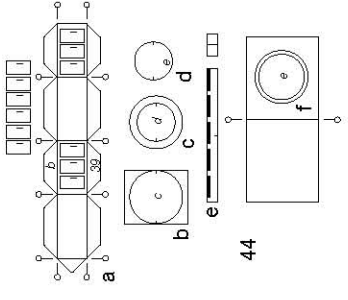
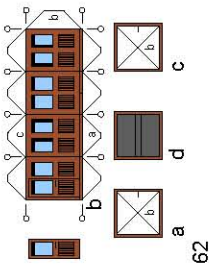
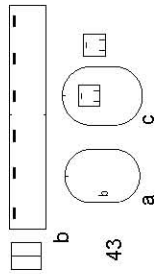
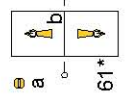
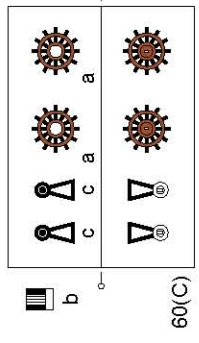
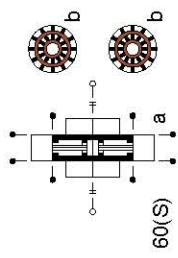
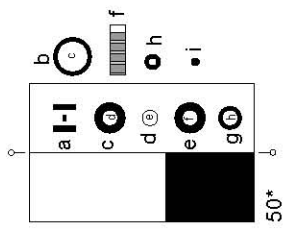
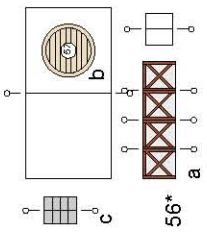
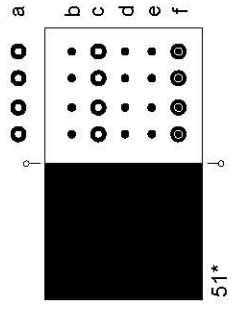
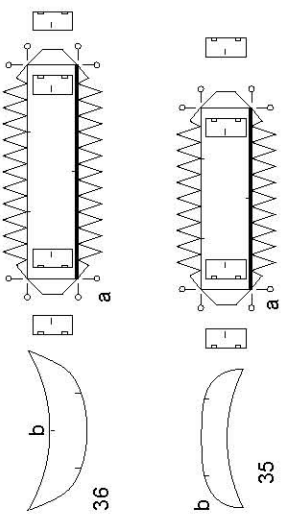
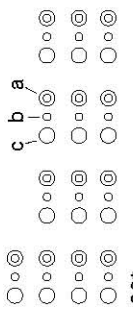
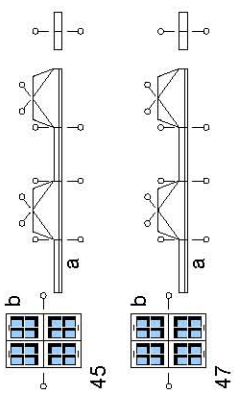
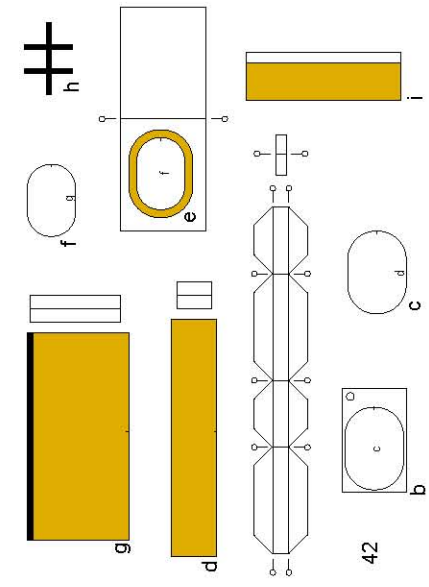
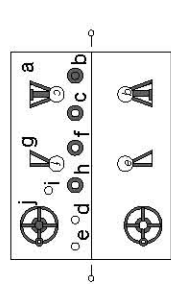
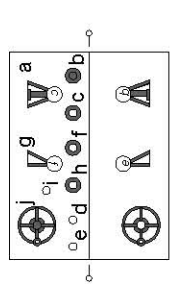
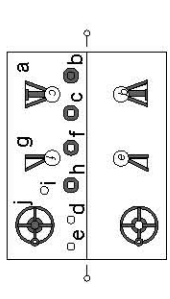
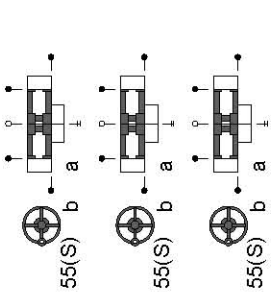

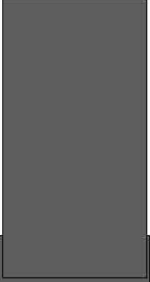
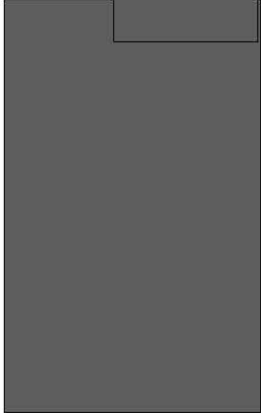
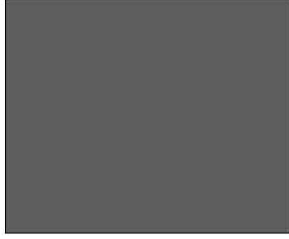

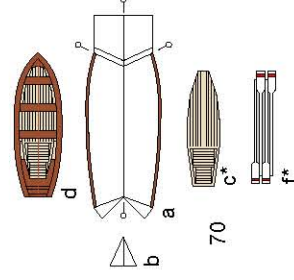
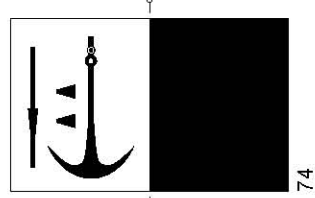
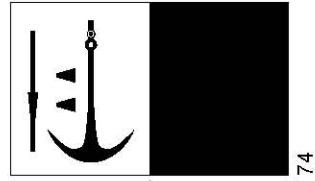
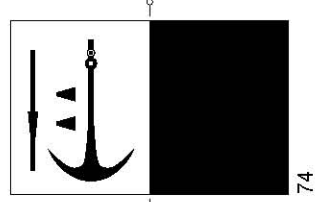
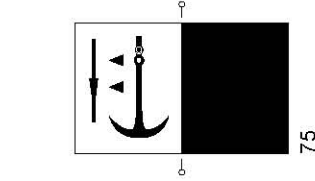
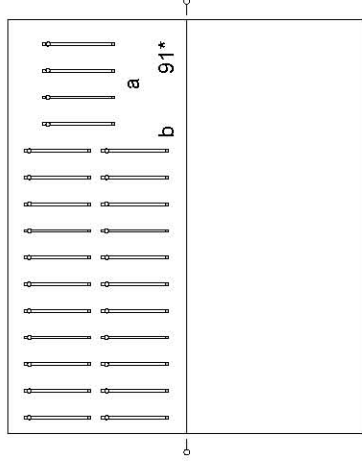
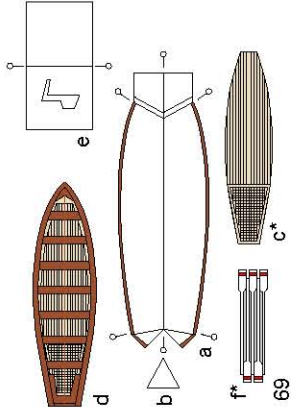
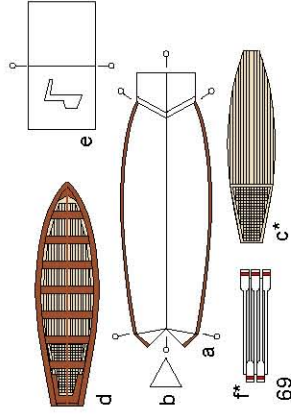
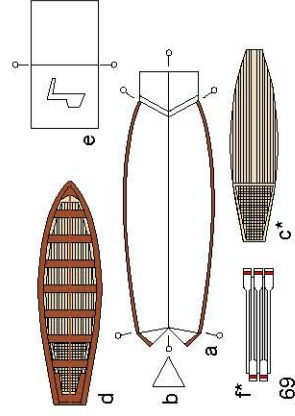
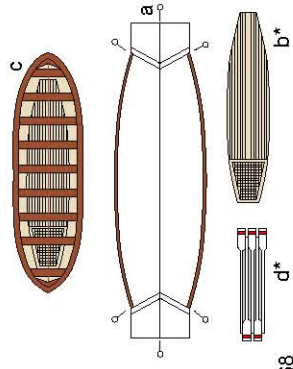
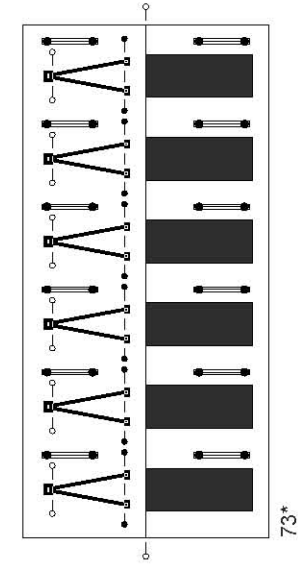
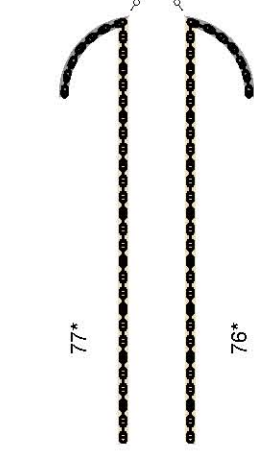
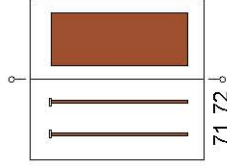
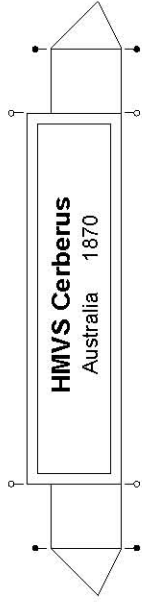
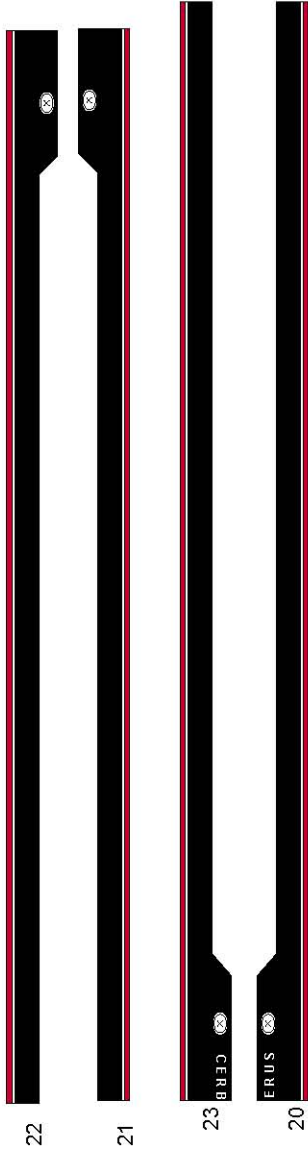

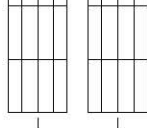
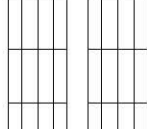
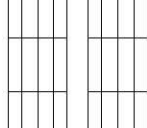
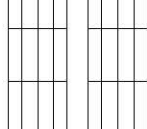
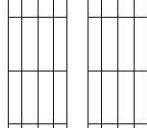
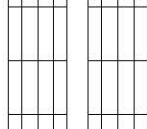
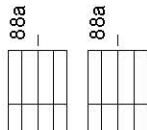
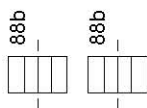
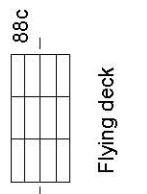
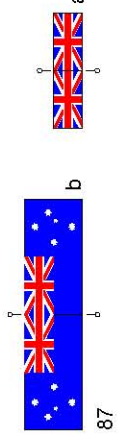

Breastwork

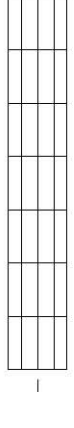
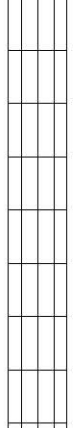
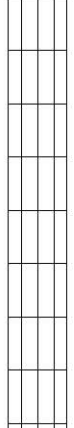
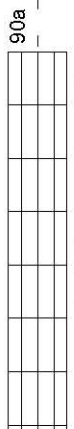
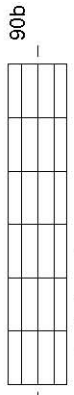
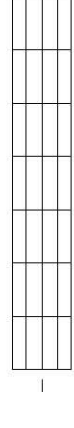
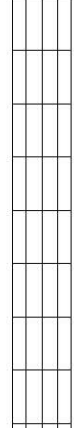
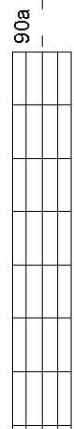
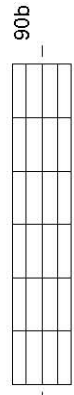
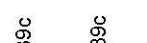
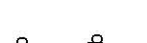
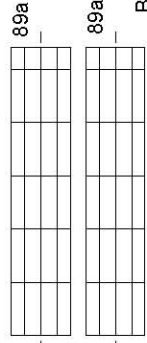

main deck - aft

main deck - forward and sides

