

KARTONOWE 1'2005  
**ABC** NUMER SPECJALNY  
ISSN 1428 - 4618

MODEL KARTONOWY  
PAPER-CARD MODEL  
KARTONMODELLBAU

**GPM**®

<http://www.gpm.pl>

NR KAT. **231**

SERIA „P”

**USS LE**

STOPIEŃ  
TRUDNOŚCI

1

2

3

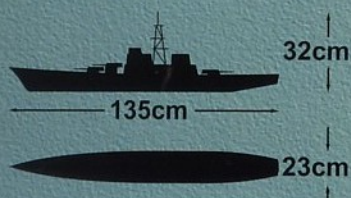

**skala 1:200**

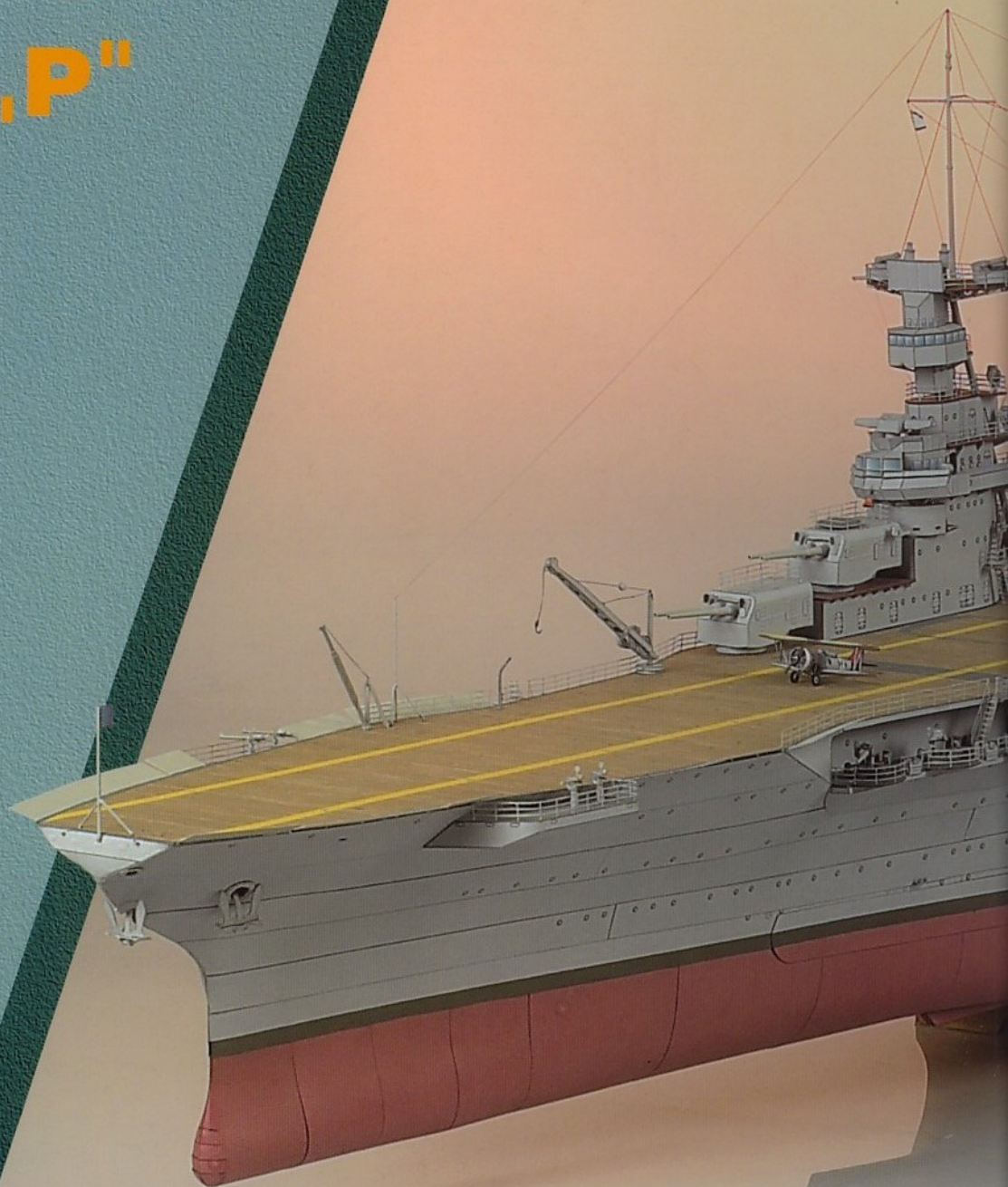

# LEXINGTON (CV-2)

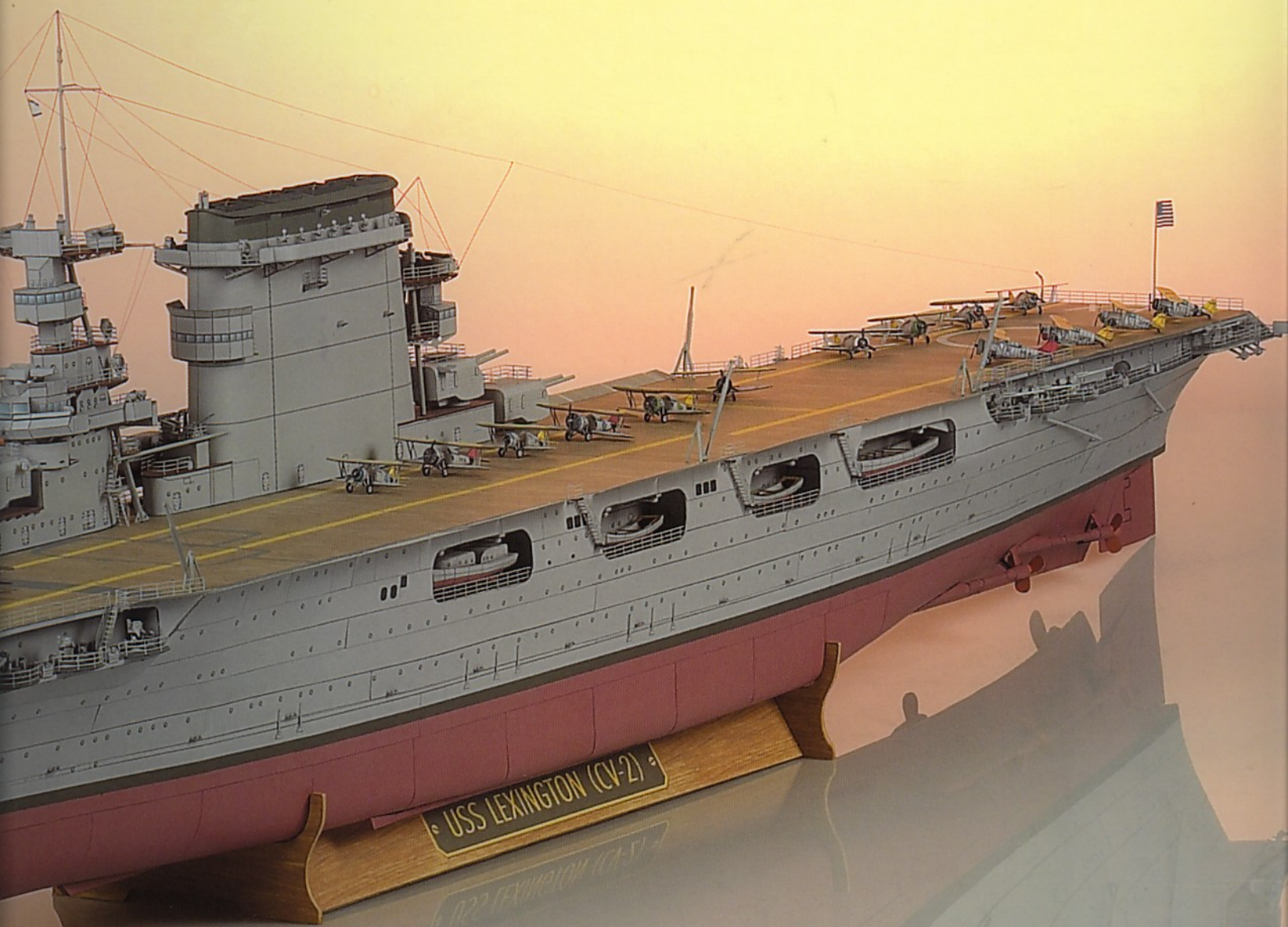

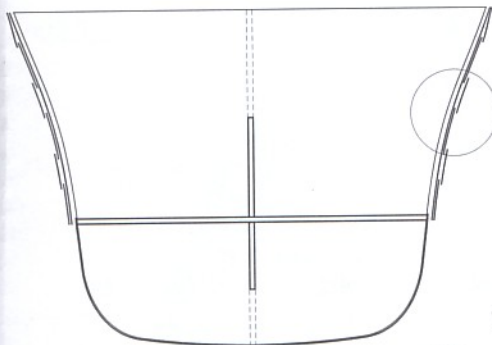

Sposób przyklejania burt -  
warstwy wewnętrznej (A) i pasów zewnętrznych (B)

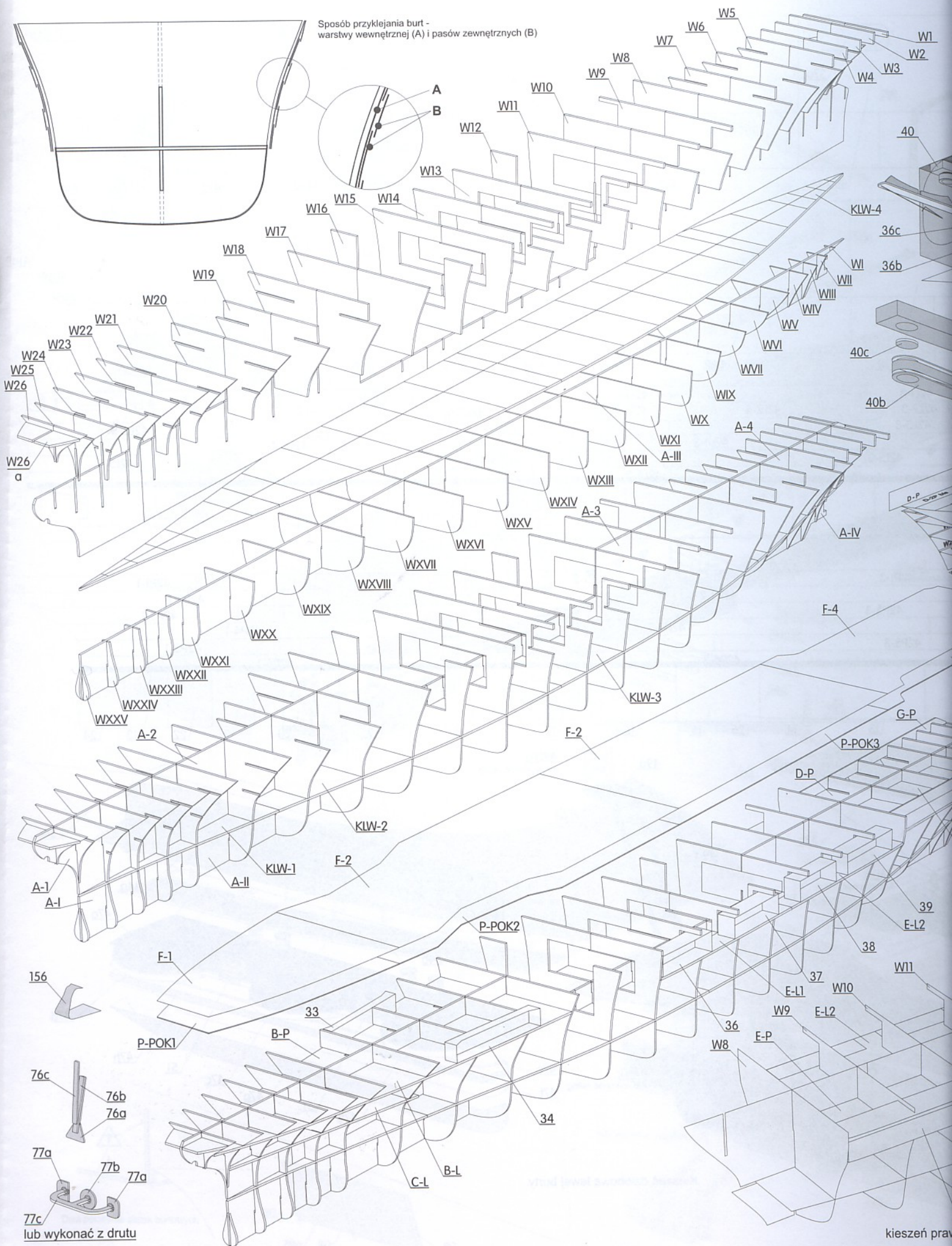
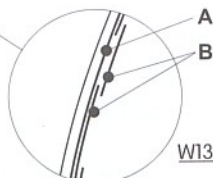

77c  
lub wykonać z drutu

kieszon praw

Analogicznie sklejać kieszeń cz.37 i 38

Analogicznie sklejać kieszeń cz.39

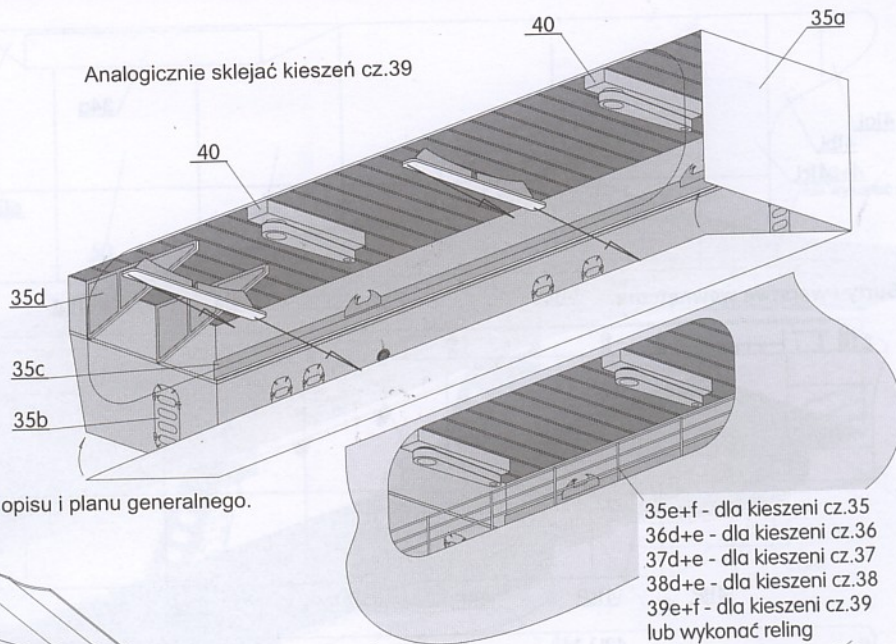
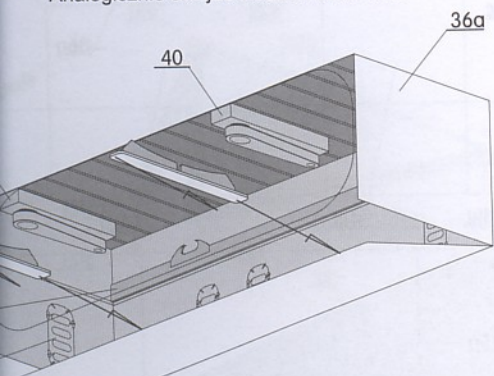

Podstawki łodzi dobierać wg opisu i planu generalnego.

35e+f - dla kieszeni cz.35  
 36d+e - dla kieszeni cz.36  
 37d+e - dla kieszeni cz.37  
 38d+e - dla kieszeni cz.38  
 39e+f - dla kieszeni cz.39  
 lub wykonać reling

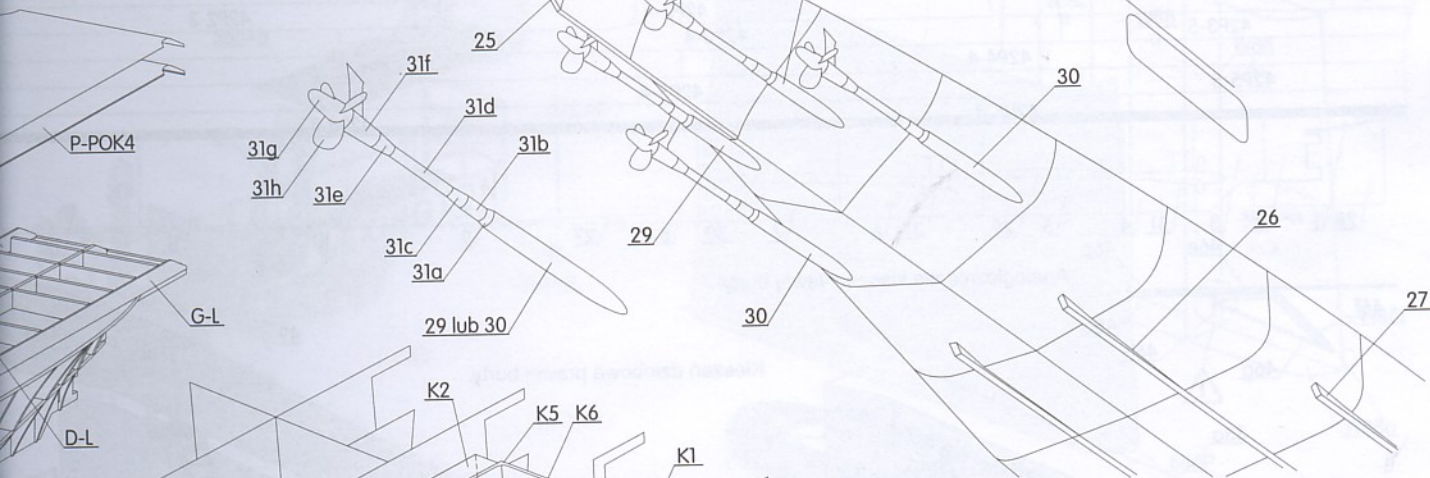
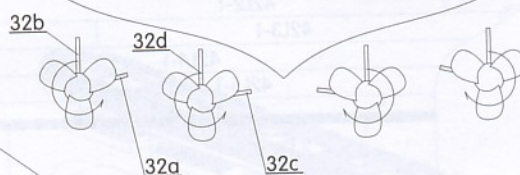
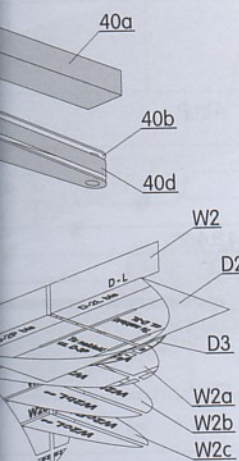

39  
2

prawy burty

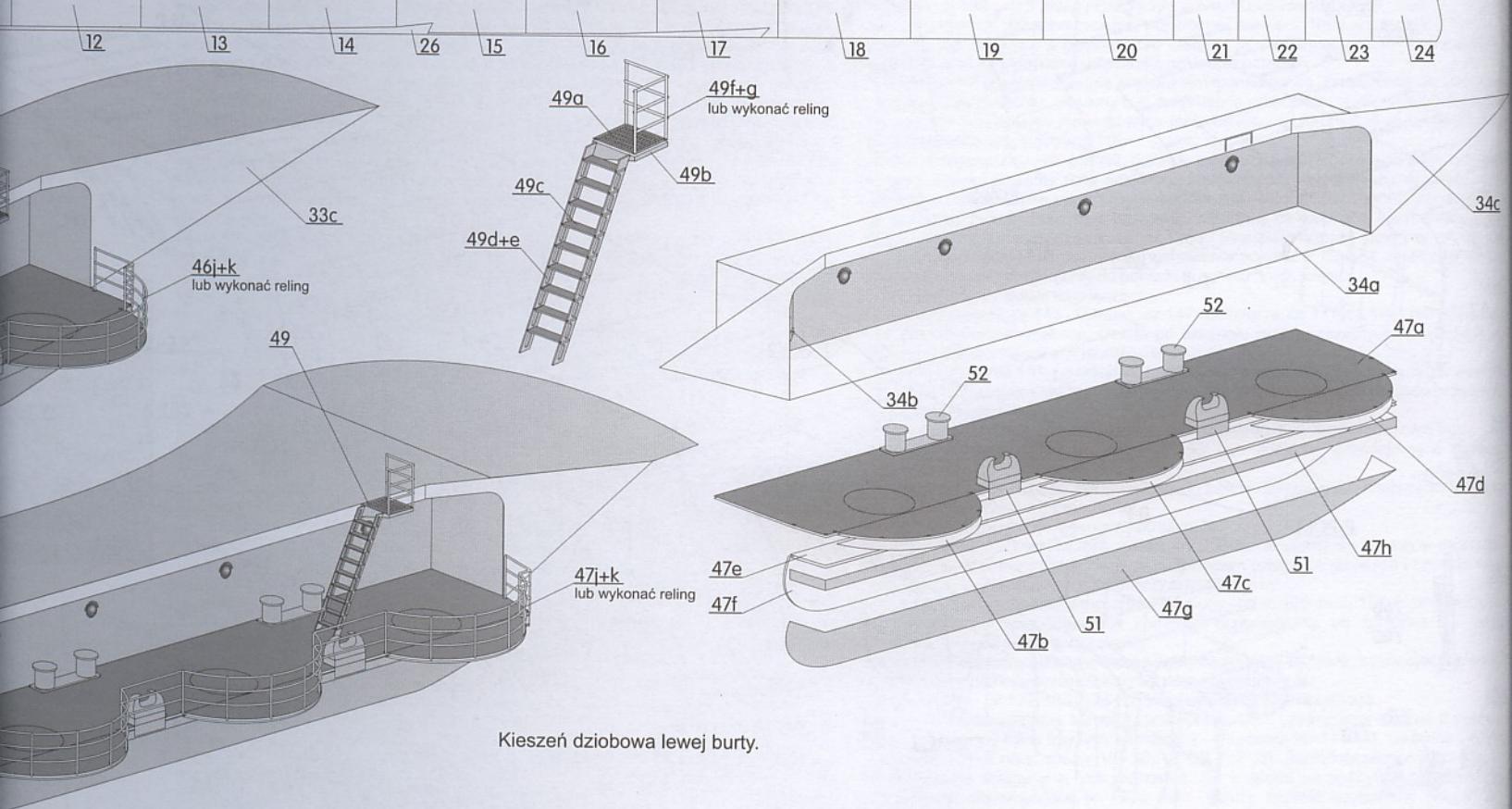
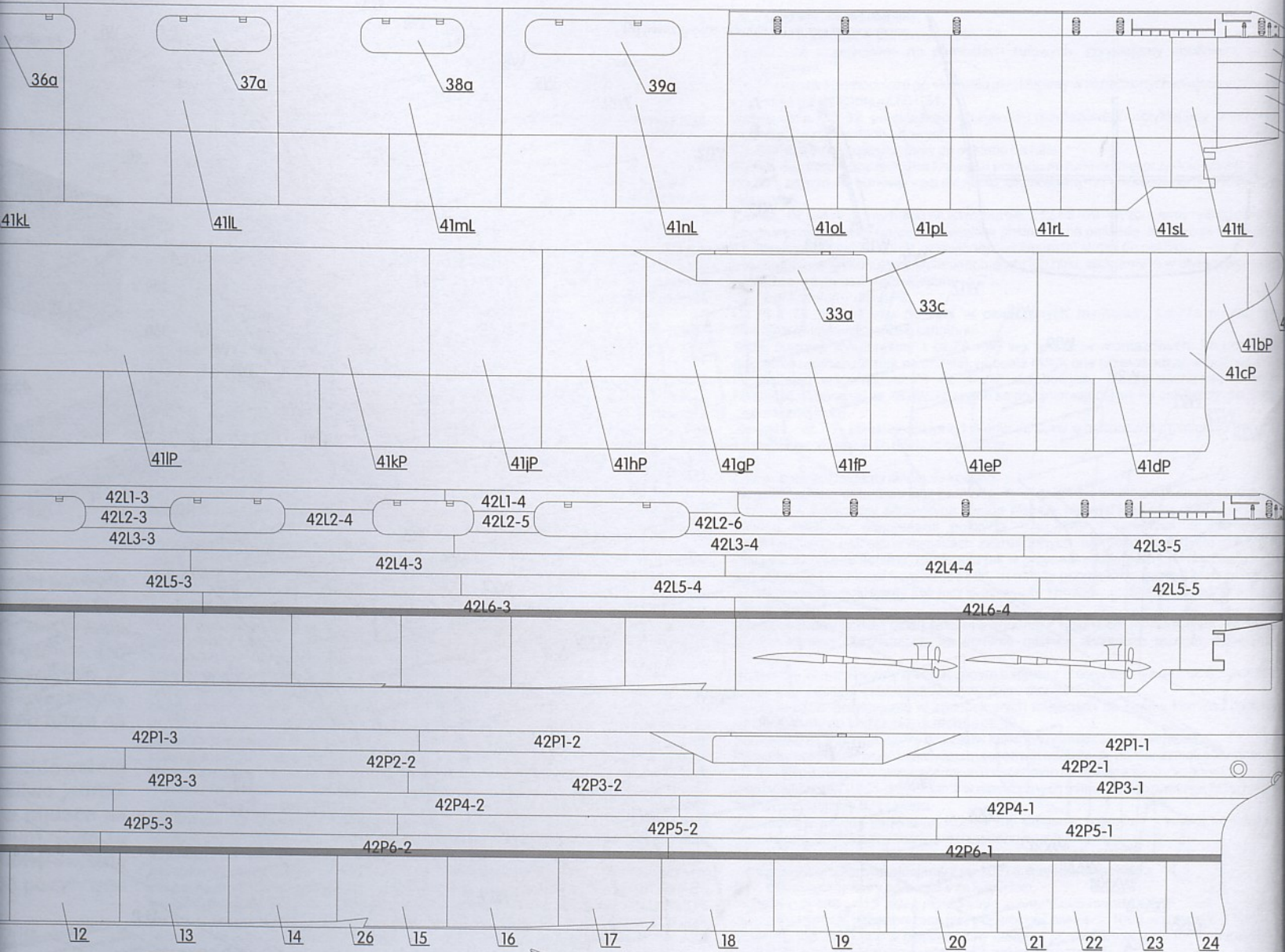

Kieszon dziobowa lewej burty.

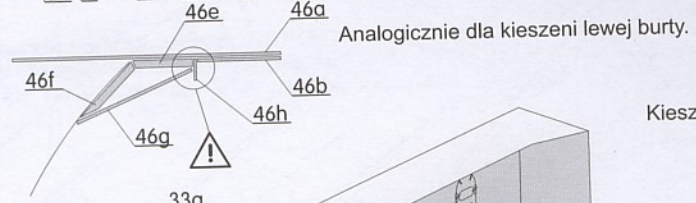
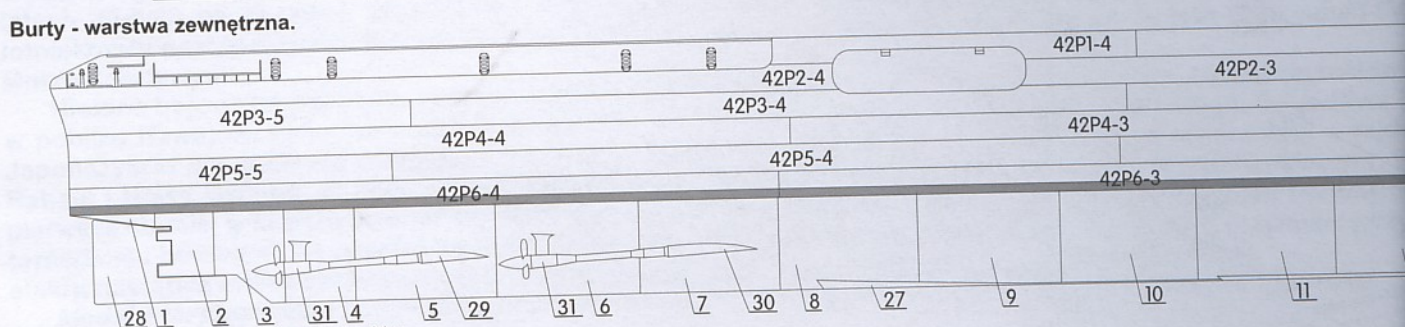
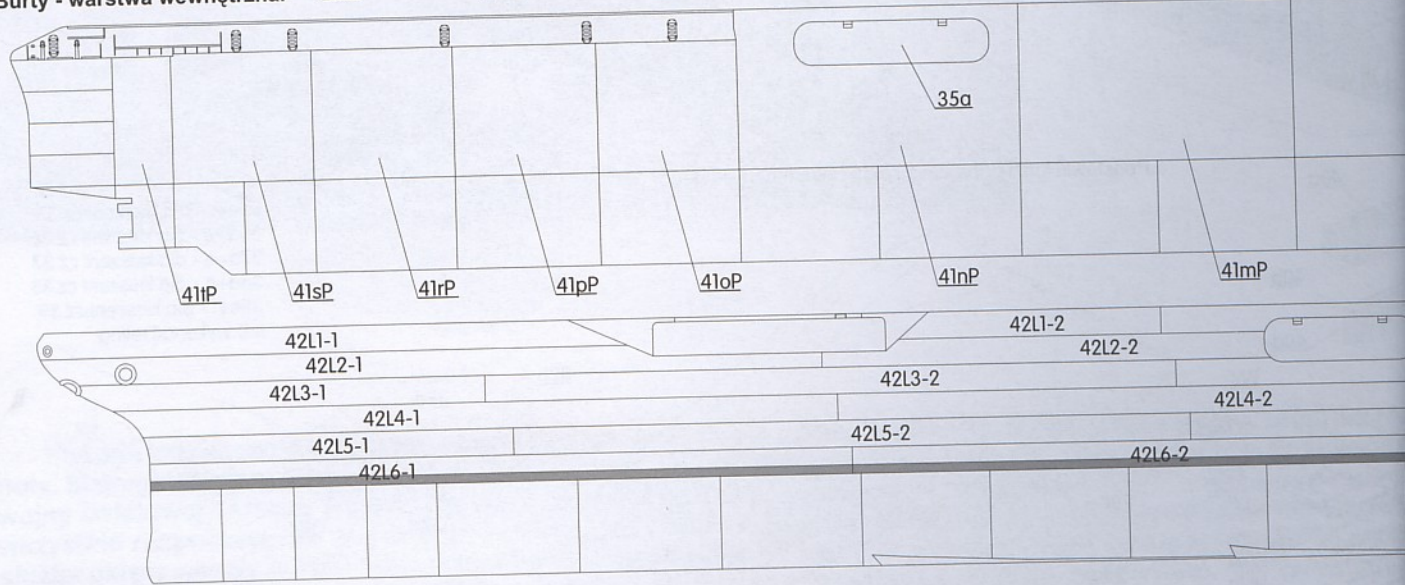
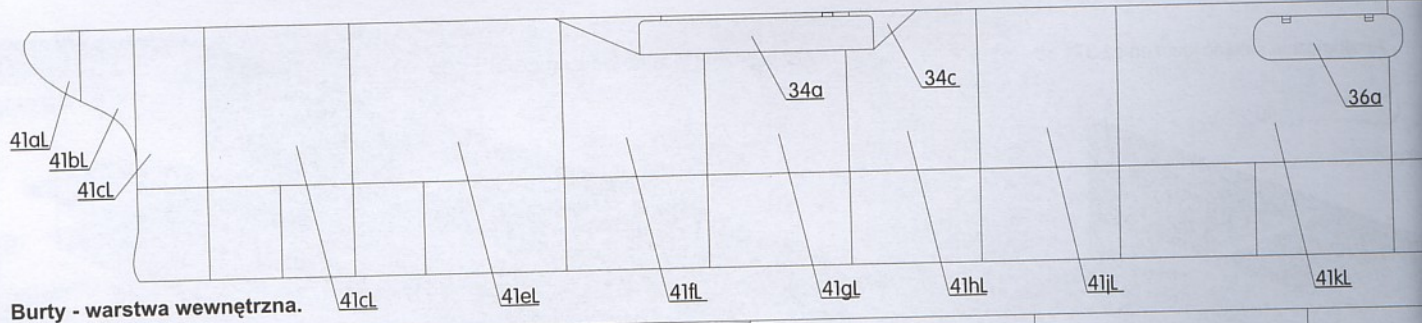

Analogicznie dla kieszeni lewej burty.

Kieszeń dziobowa prawej burty.

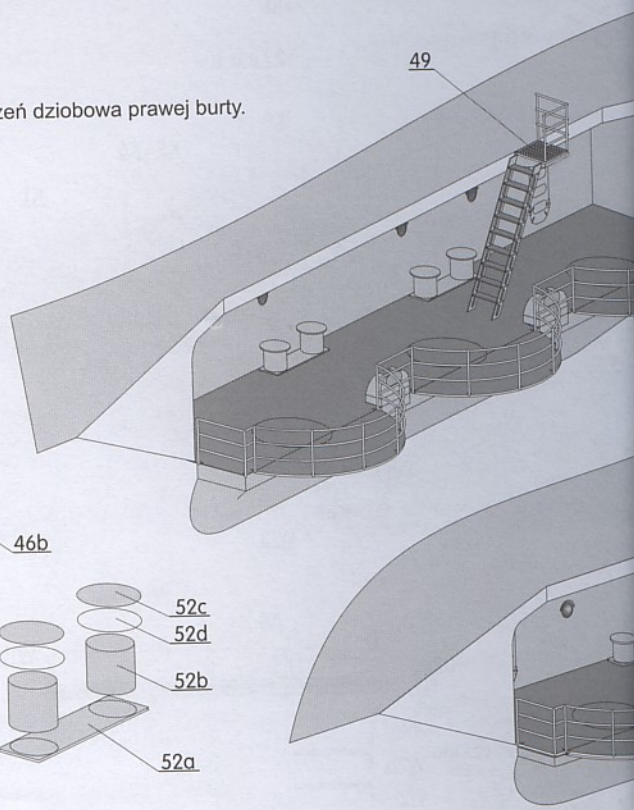
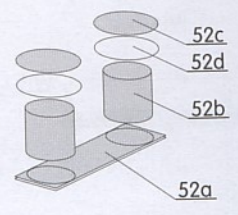
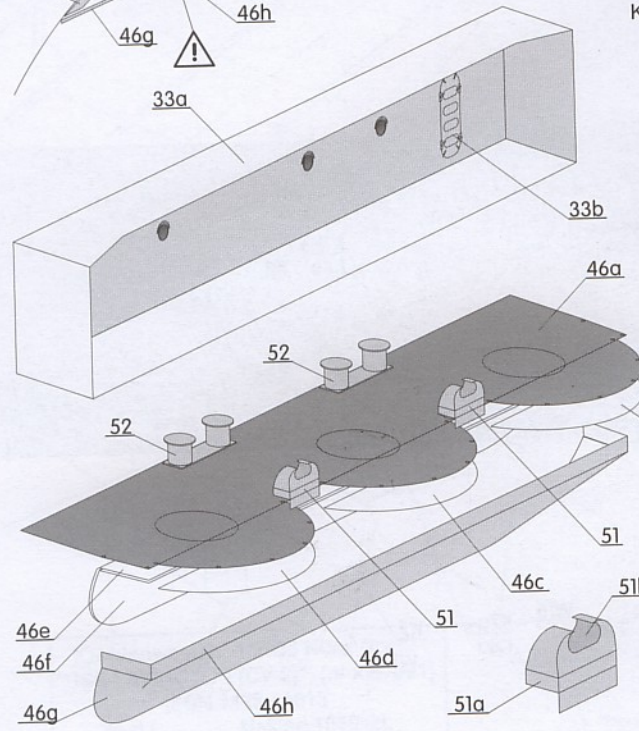

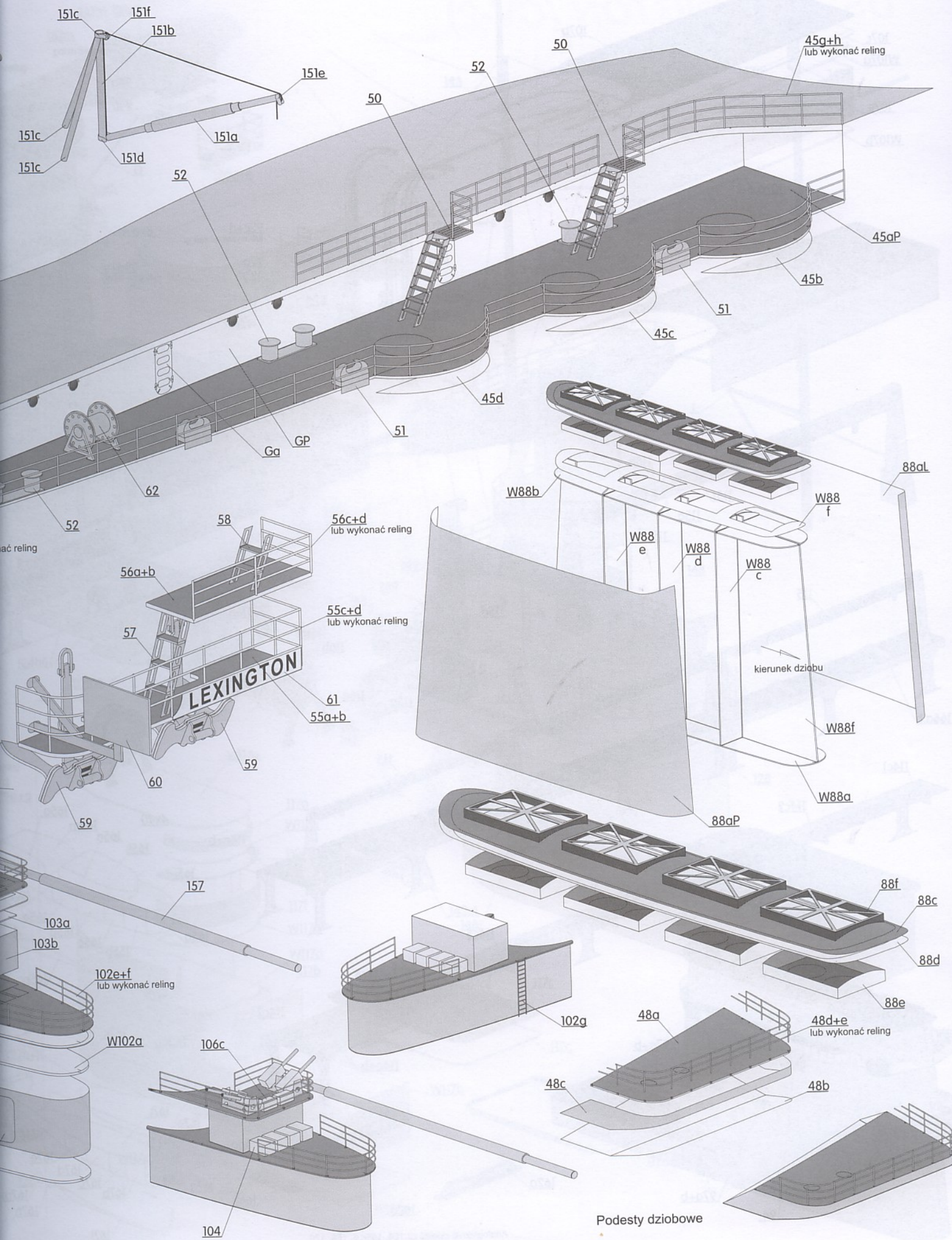

LEXINGTON

Podesty dziobowe

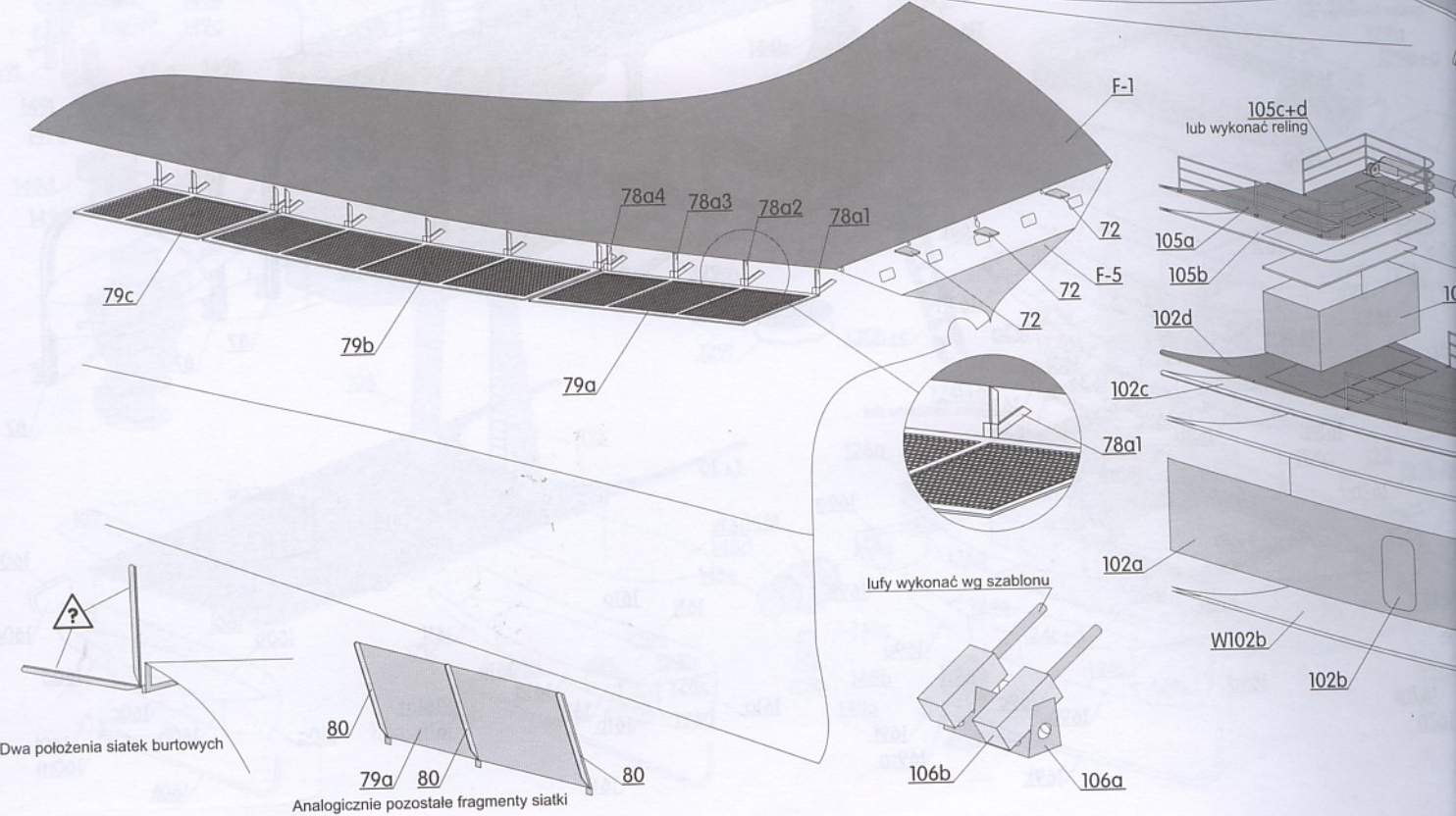
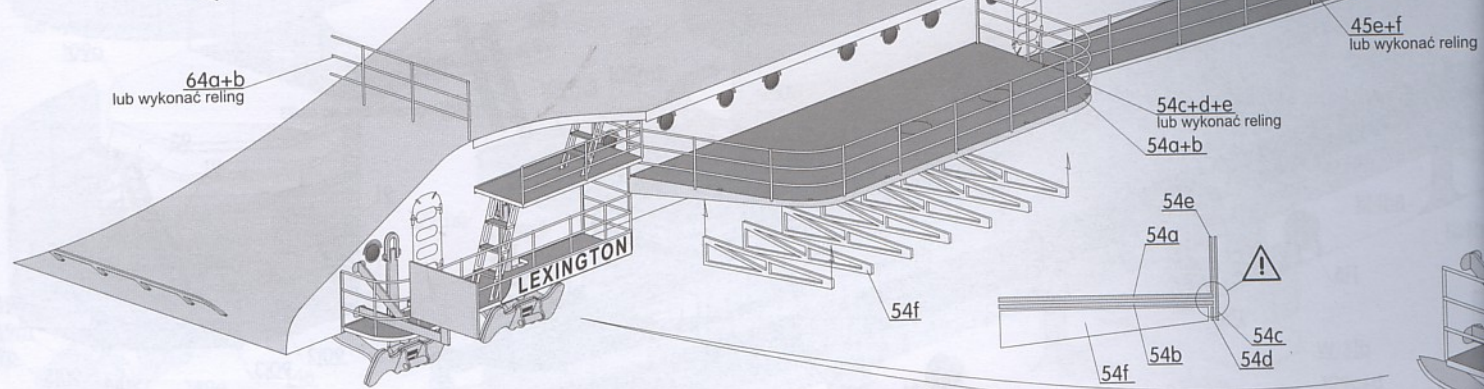
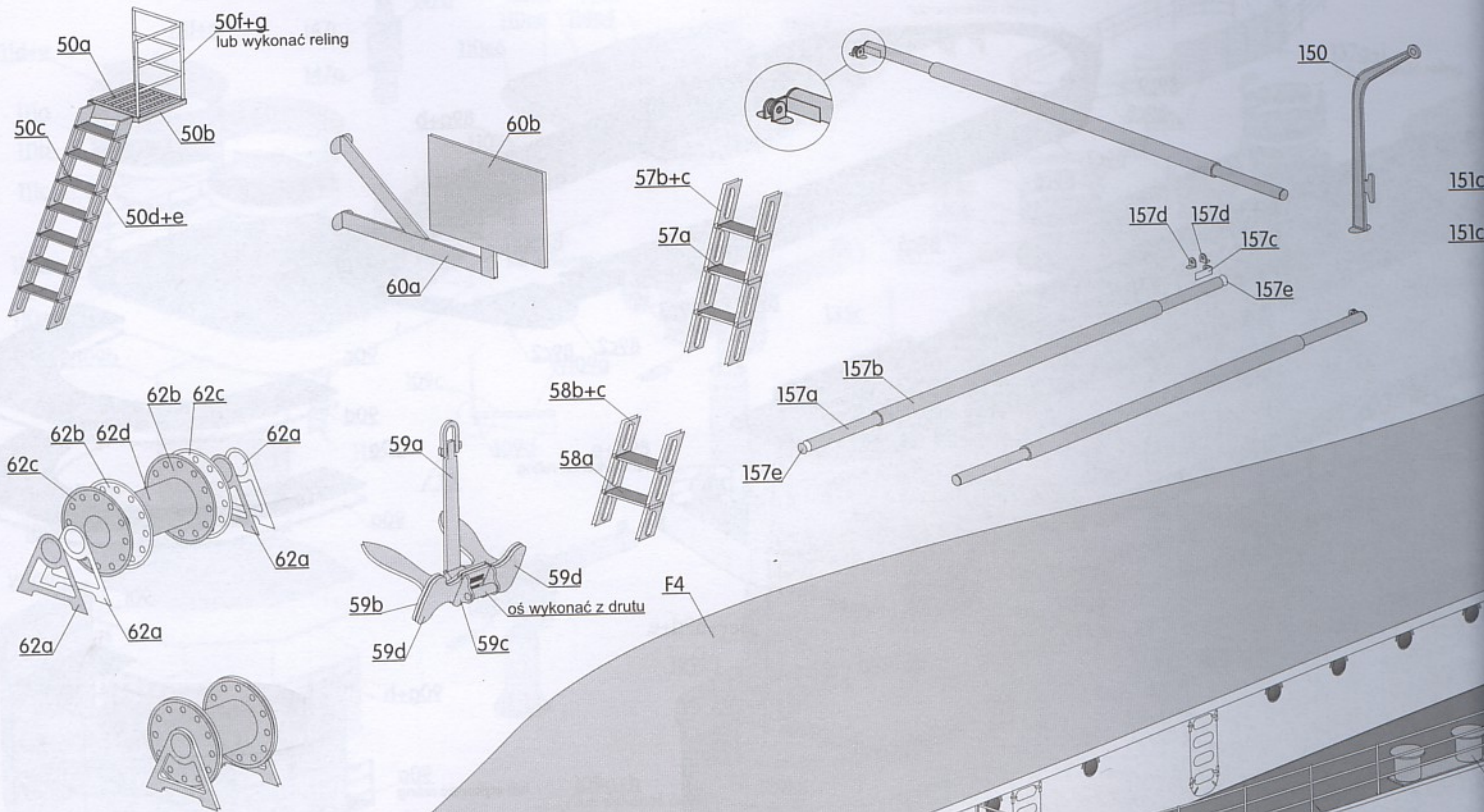





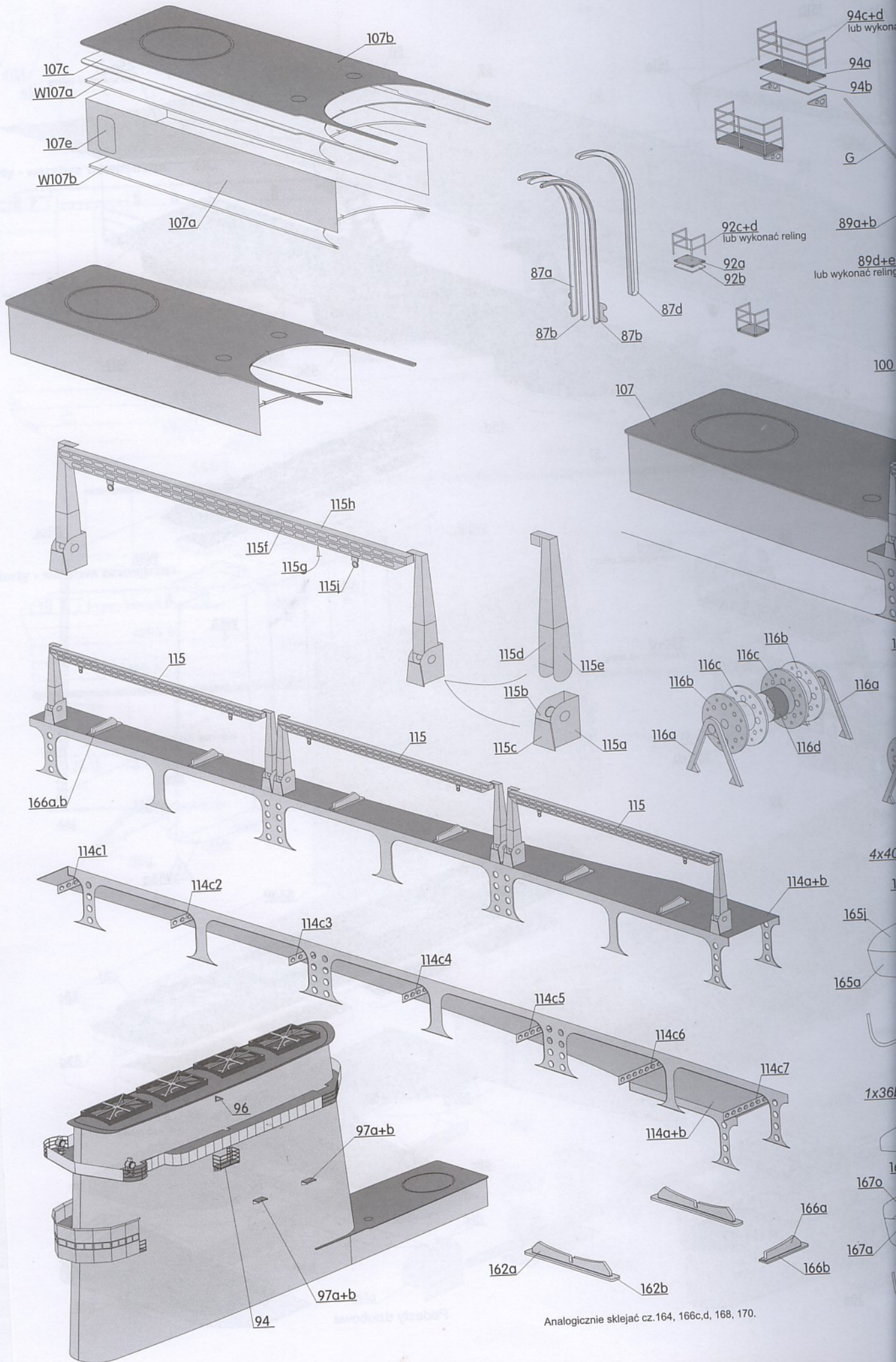

Analogicznie sklejać cz. 164, 166c,d, 168, 170.



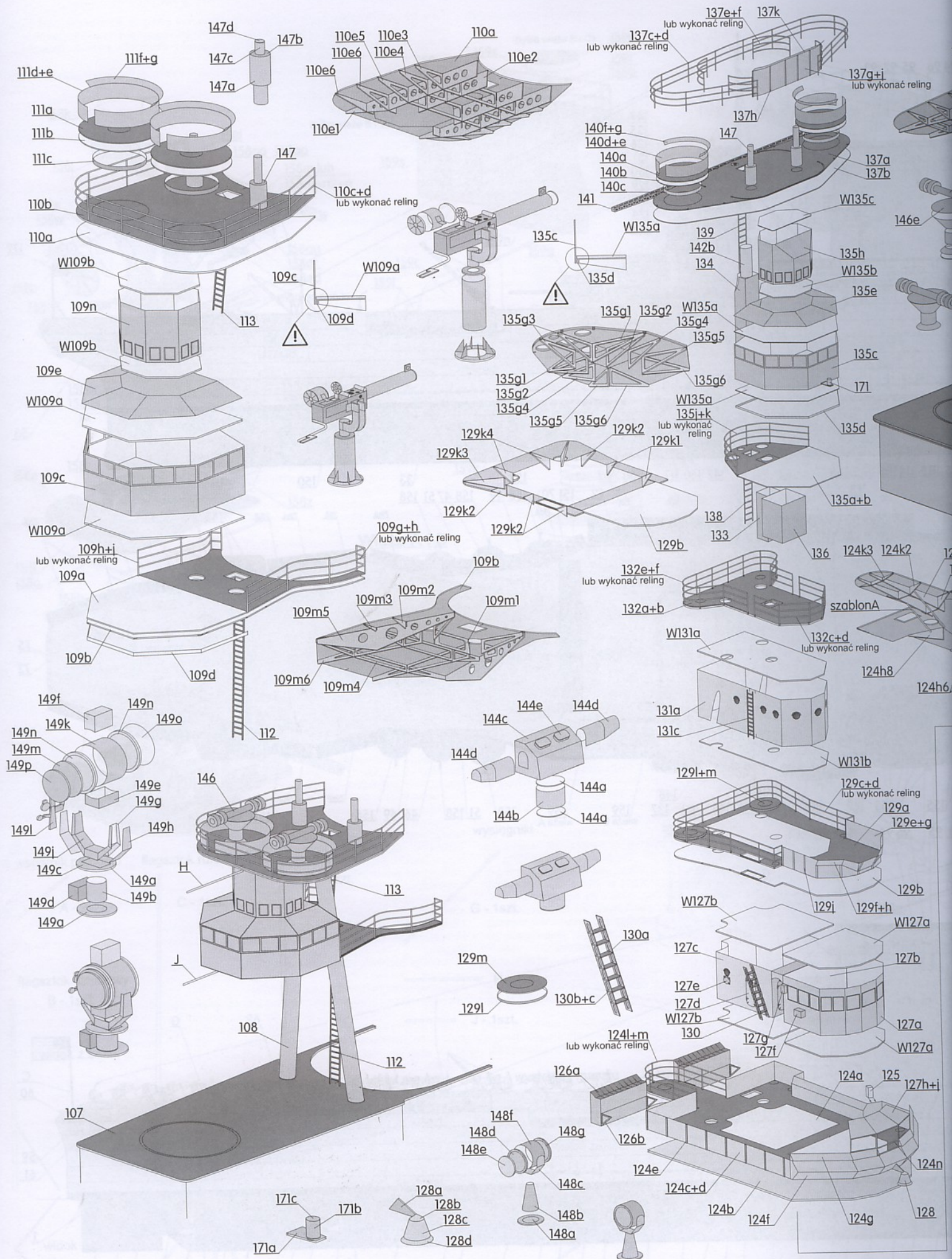

### Grumman SF-1

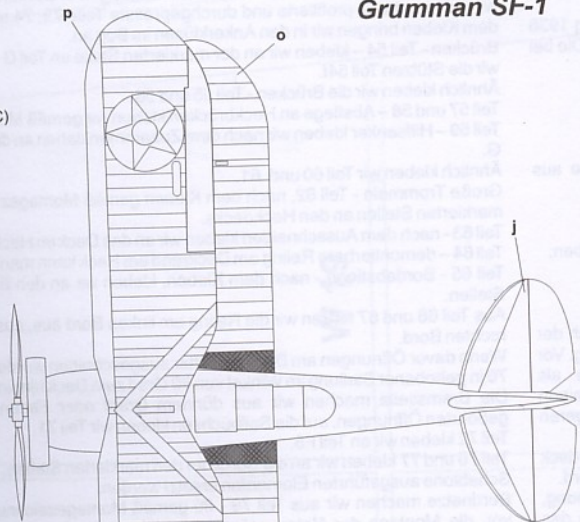

### Grumman F2F-1

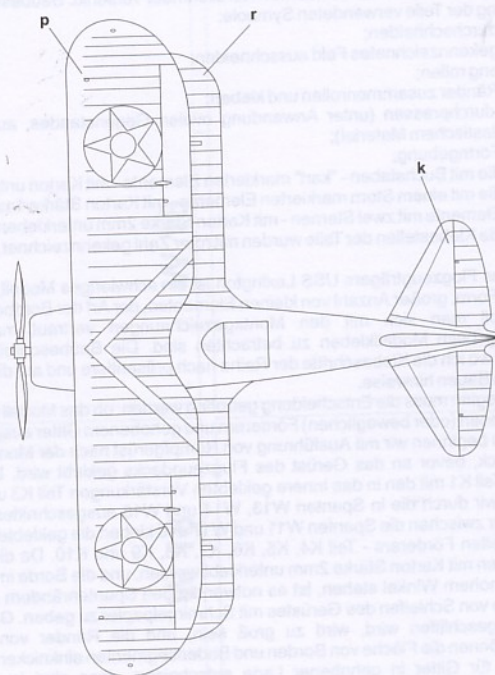

### Wieża B i C

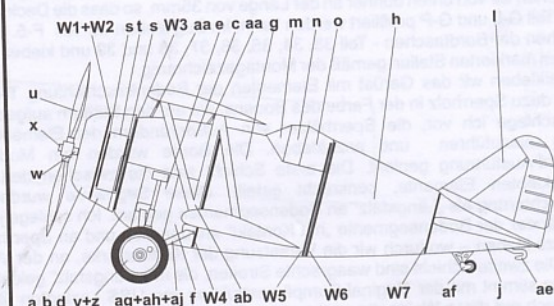
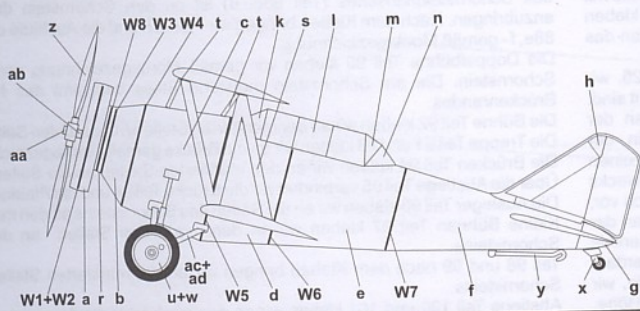
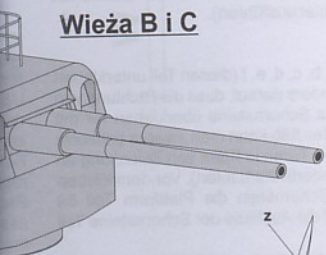

### Grumman F3F-2

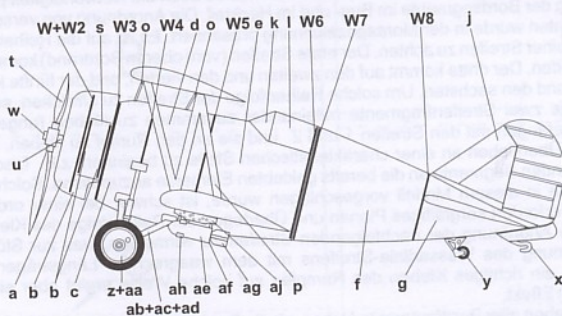
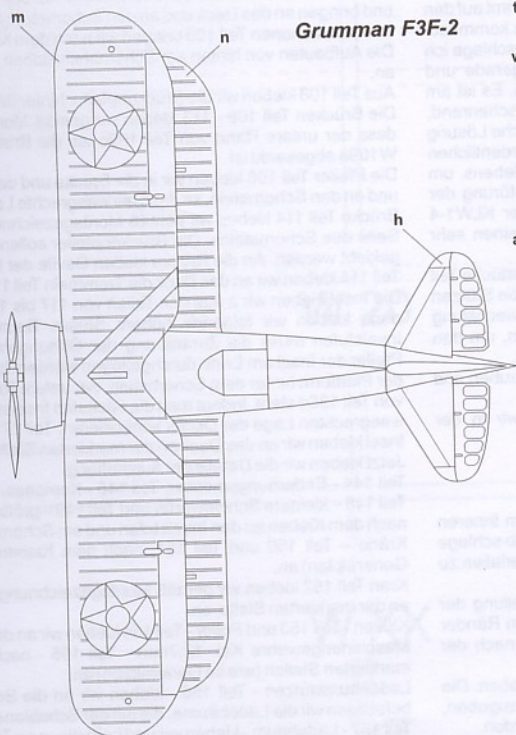

### Sposób podnoszenia parawanu lotniczego

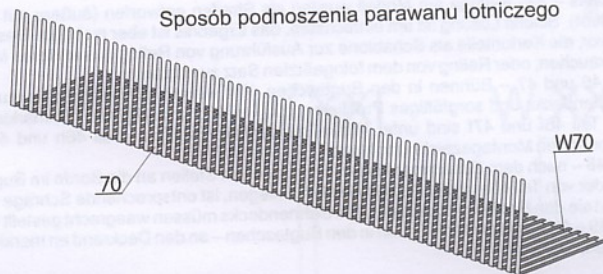

159r  
(tylko wieża B i C)

159m

159h

+ag  
o 152ac

152ad+ae

152w

152s

152f

152c

152d

152b

152a

ufowe N - 4szt.

70

W70

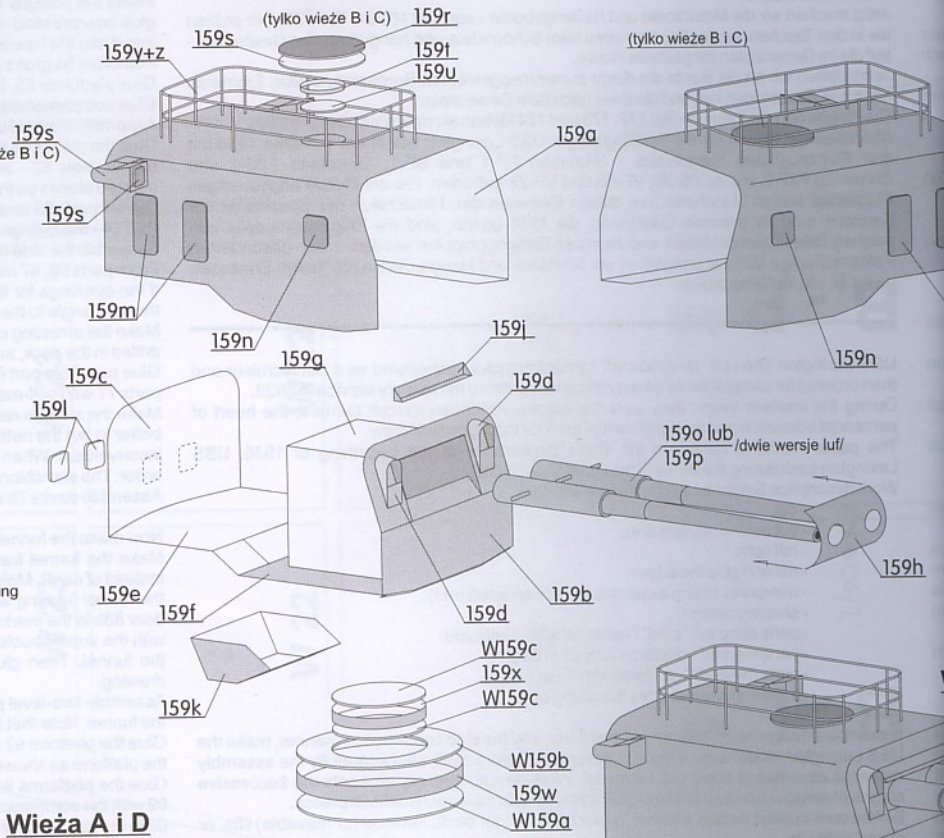
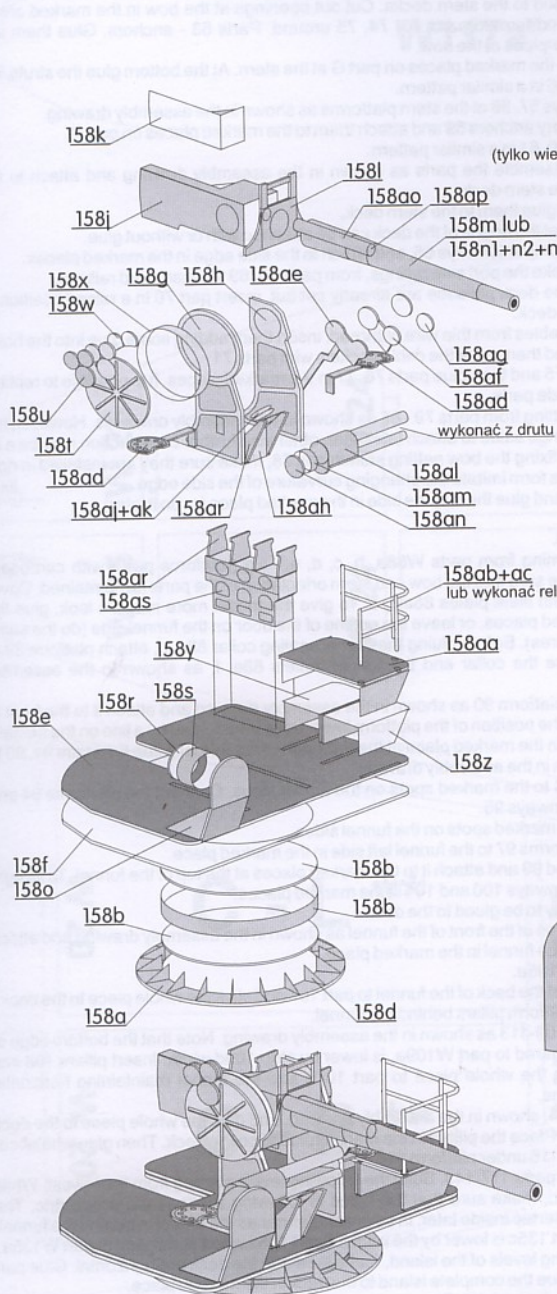

**Wieża A i D**

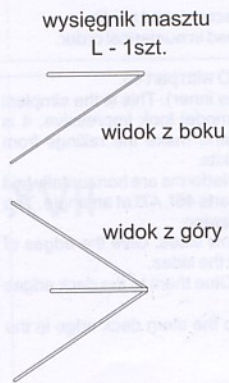
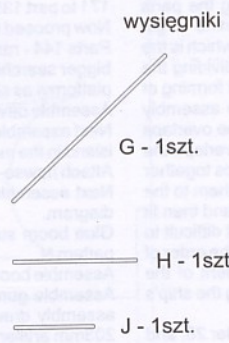
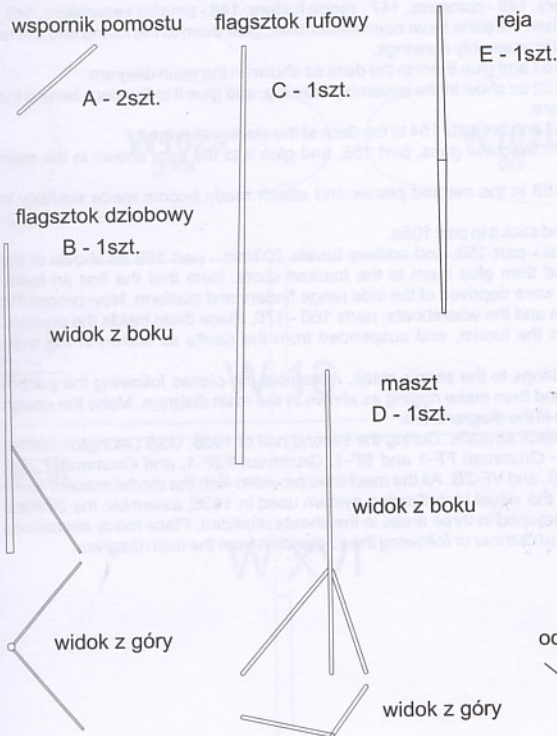
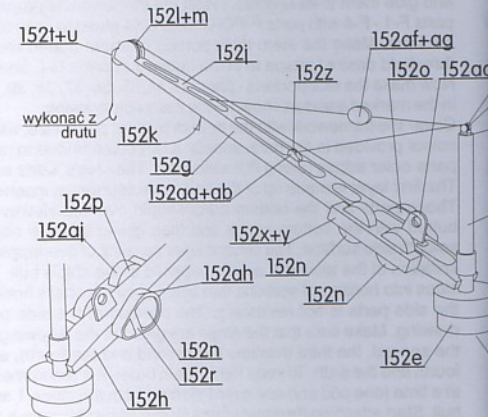
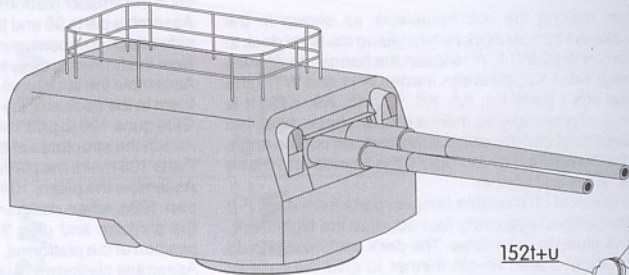

bomy rufowe

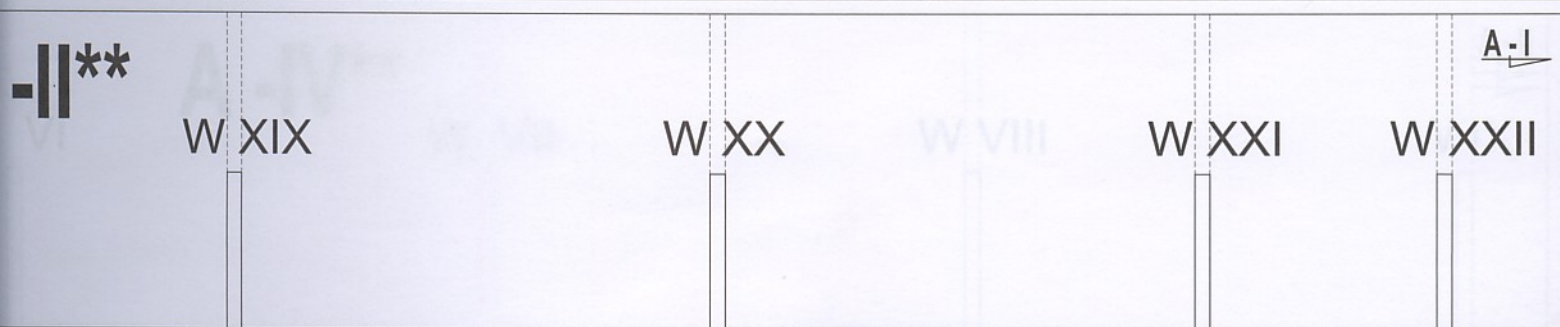
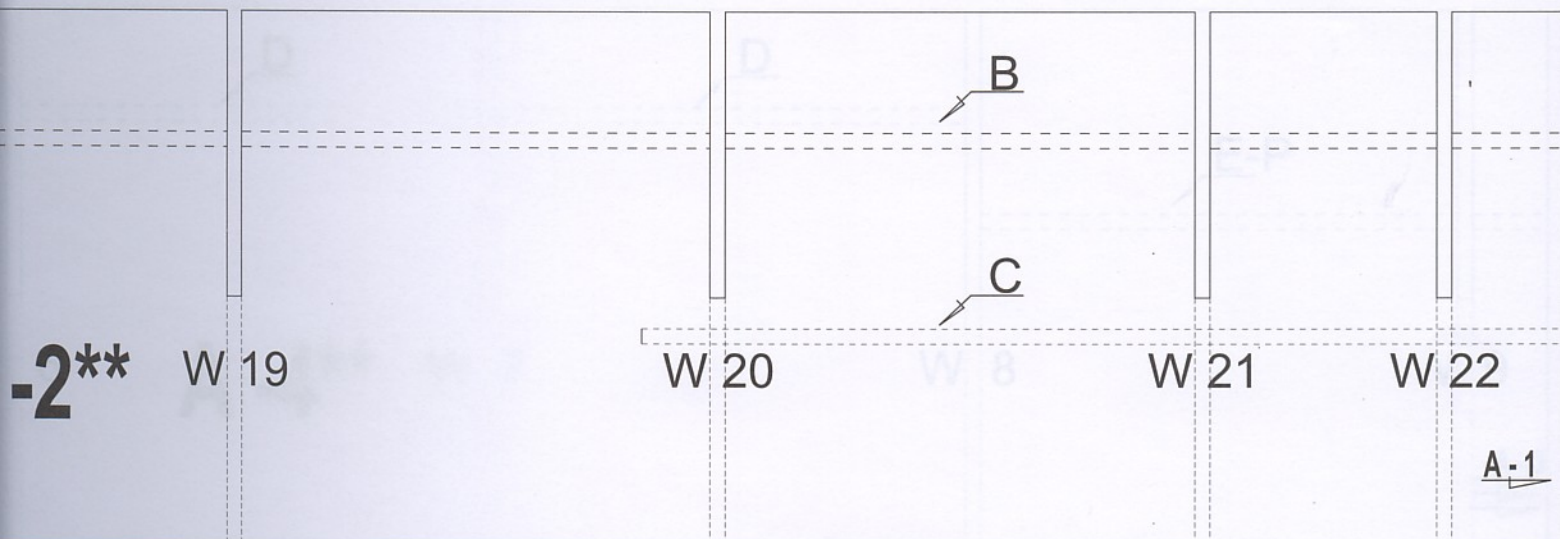
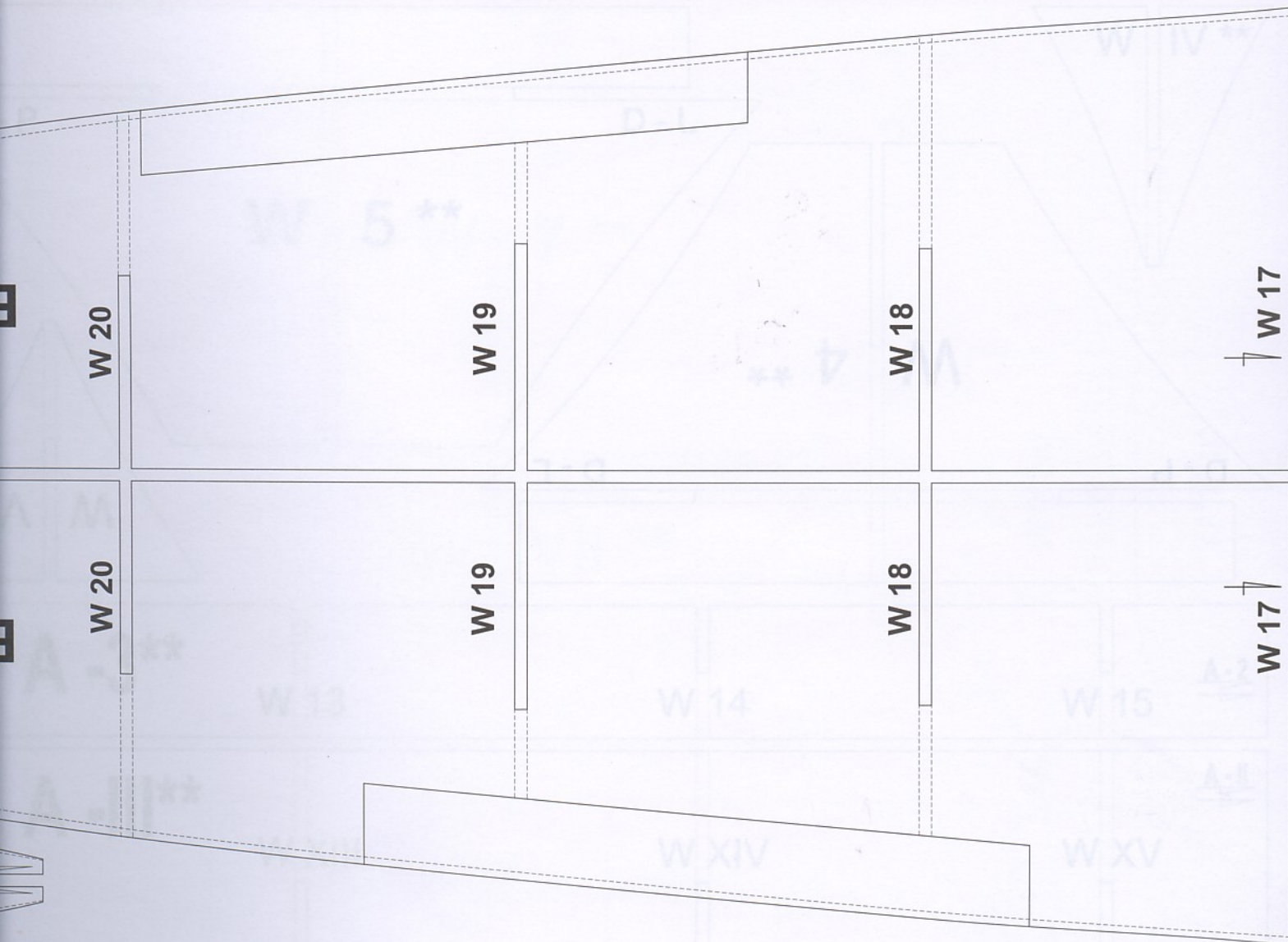

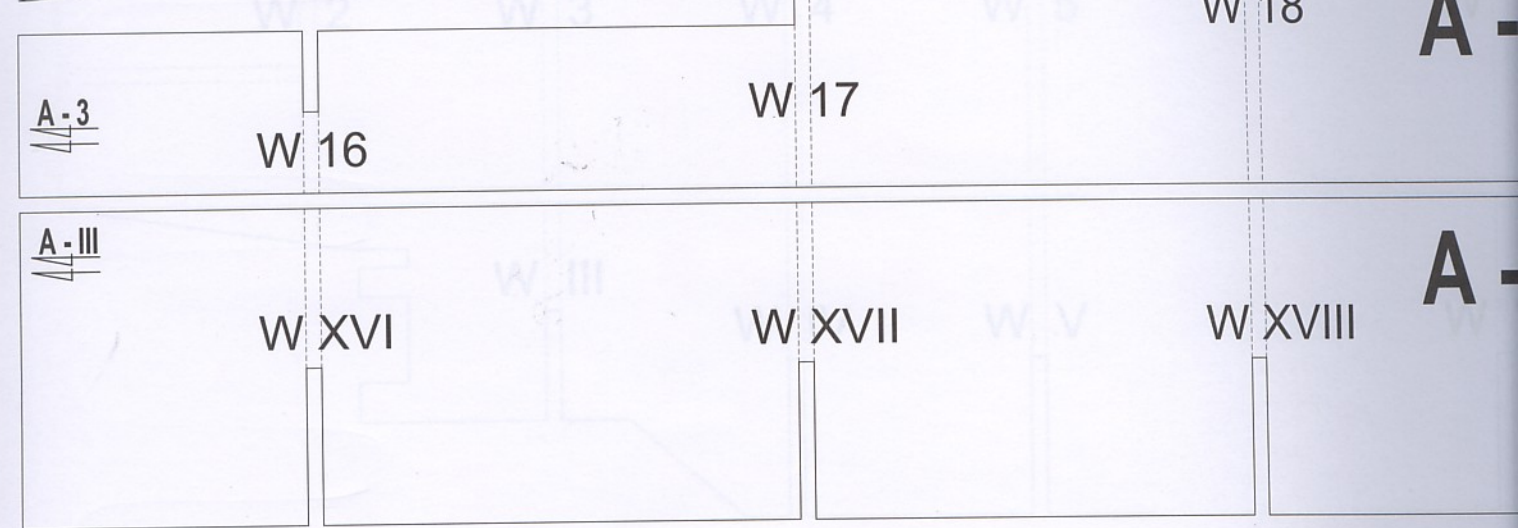
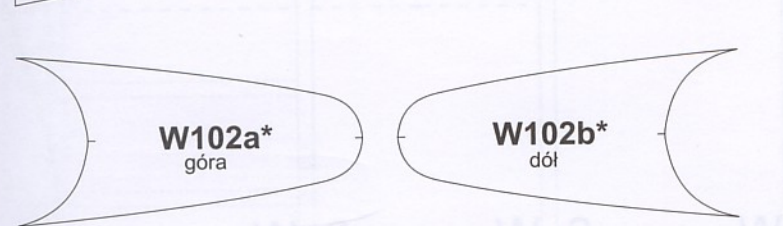
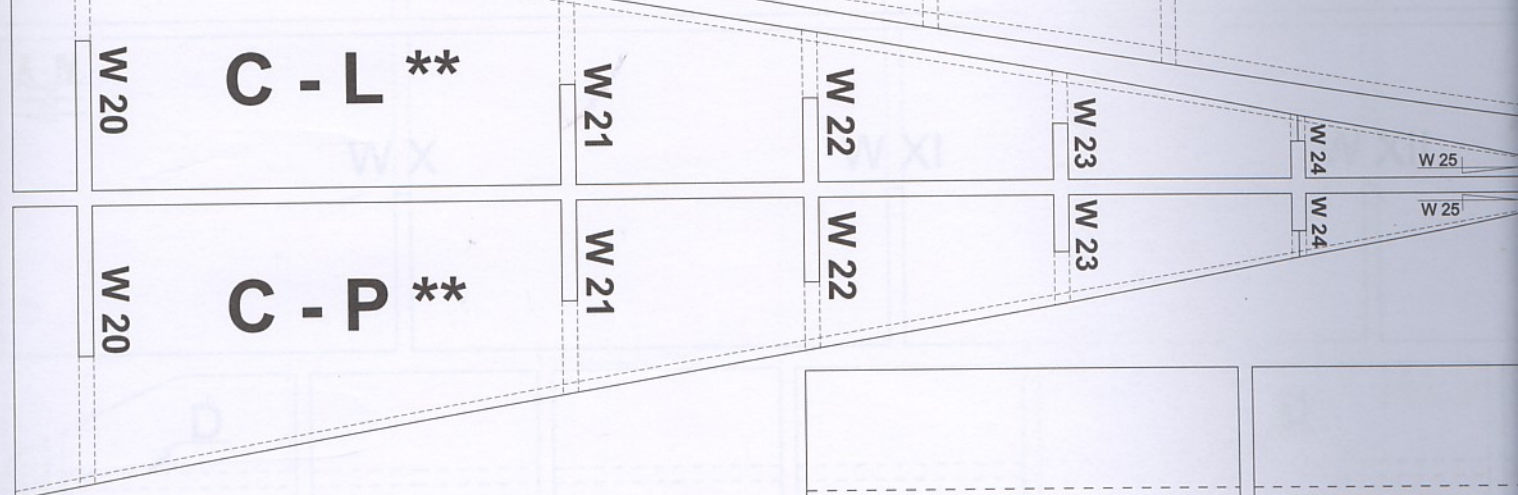
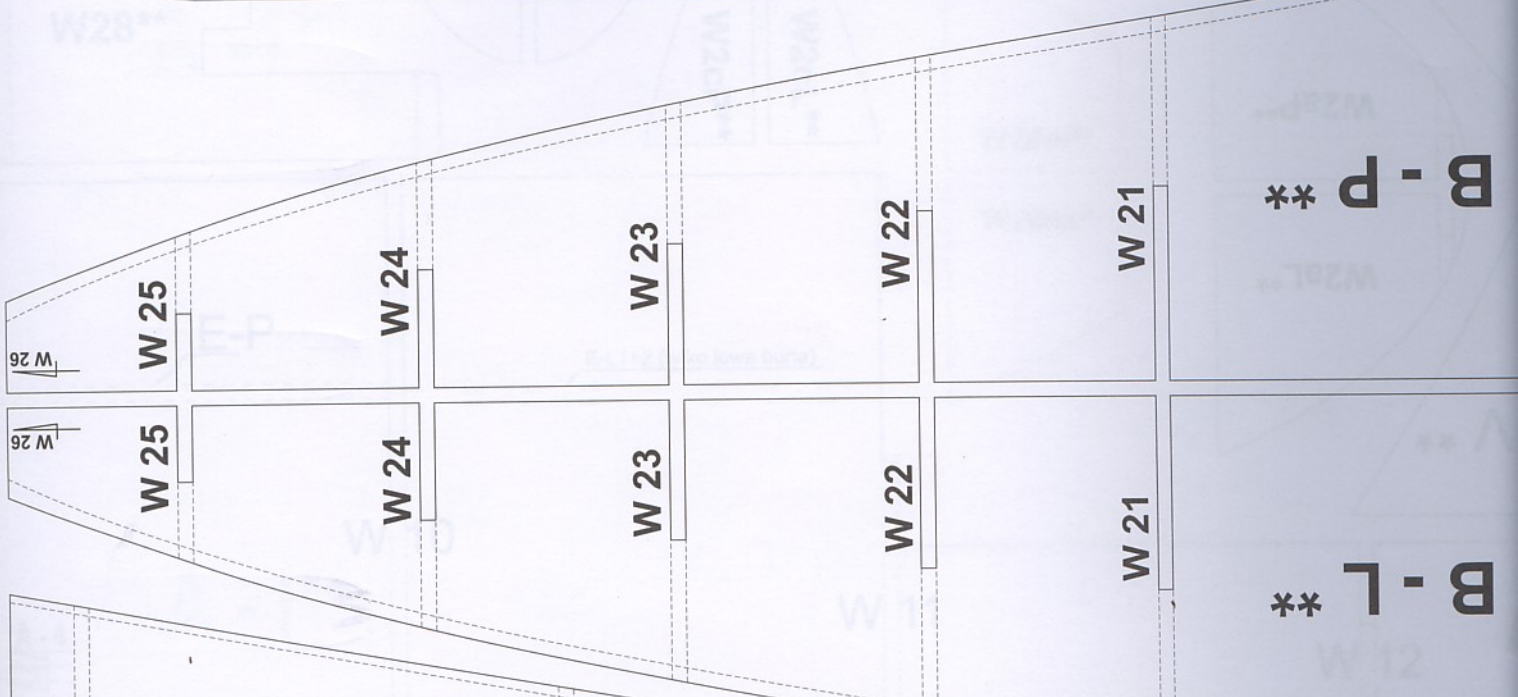
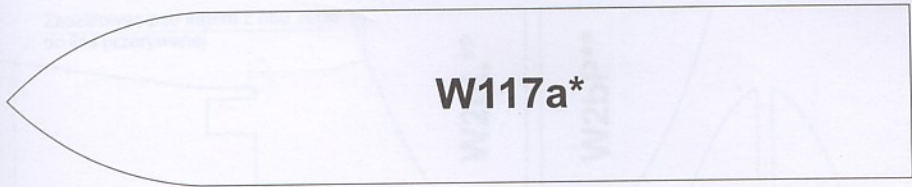



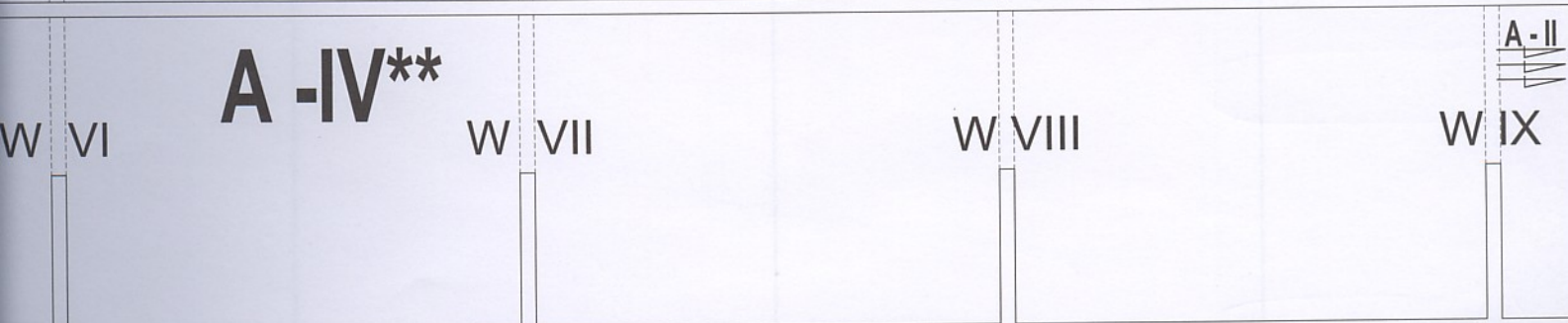
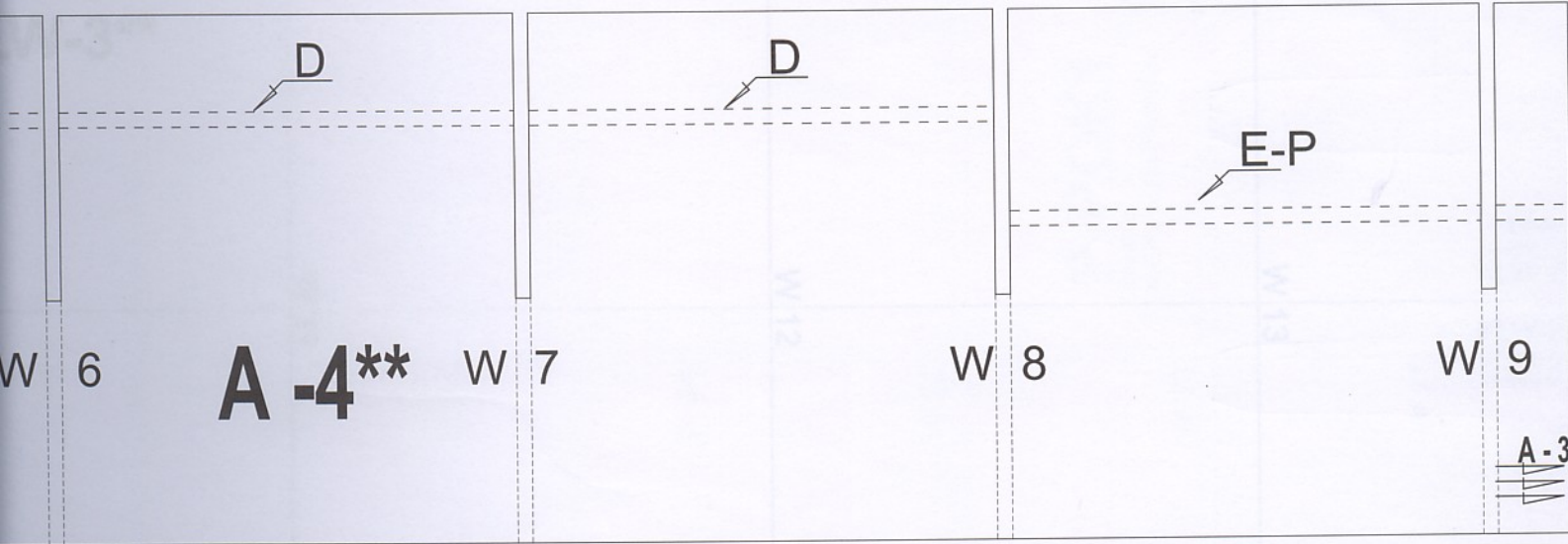
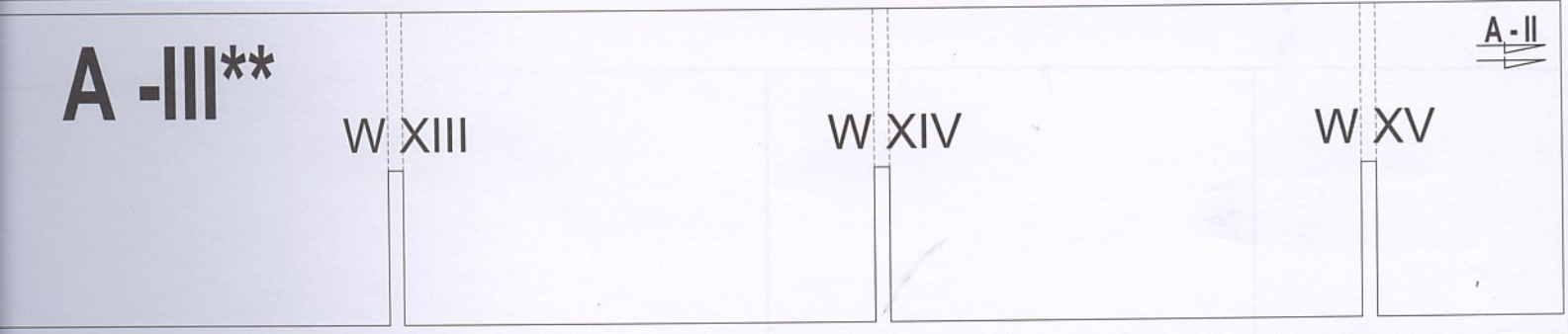
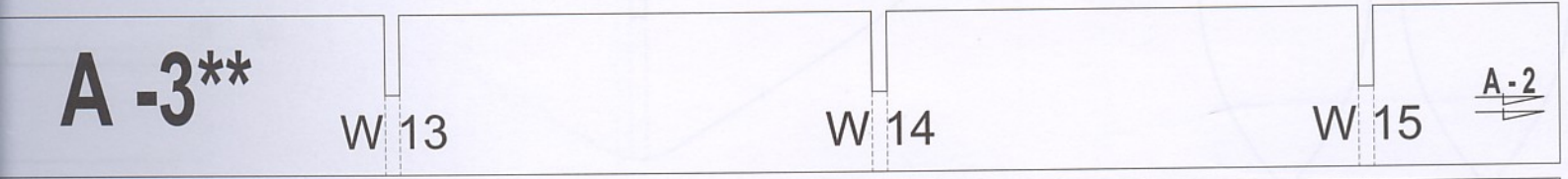
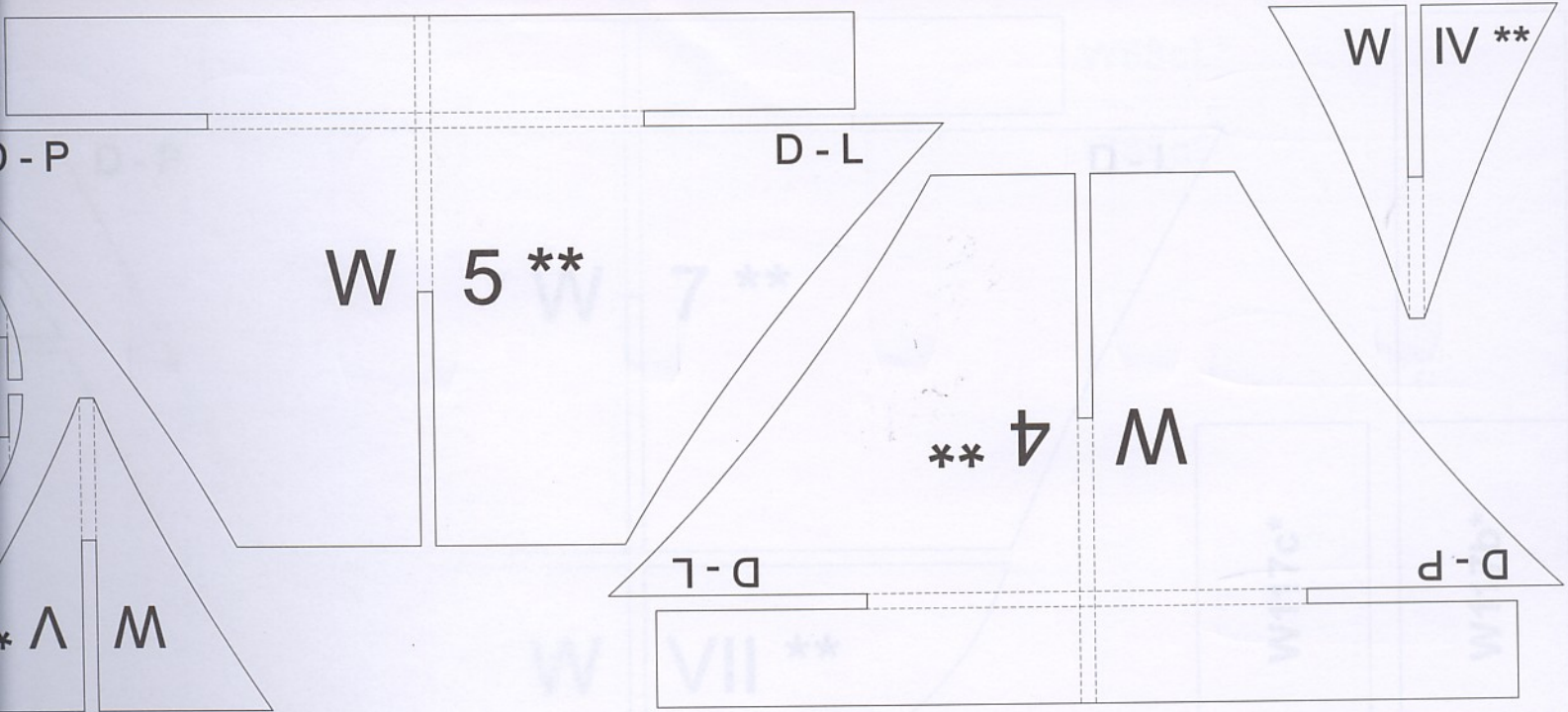

Zeszlić pod kątem z obu stron do linii przerywanej

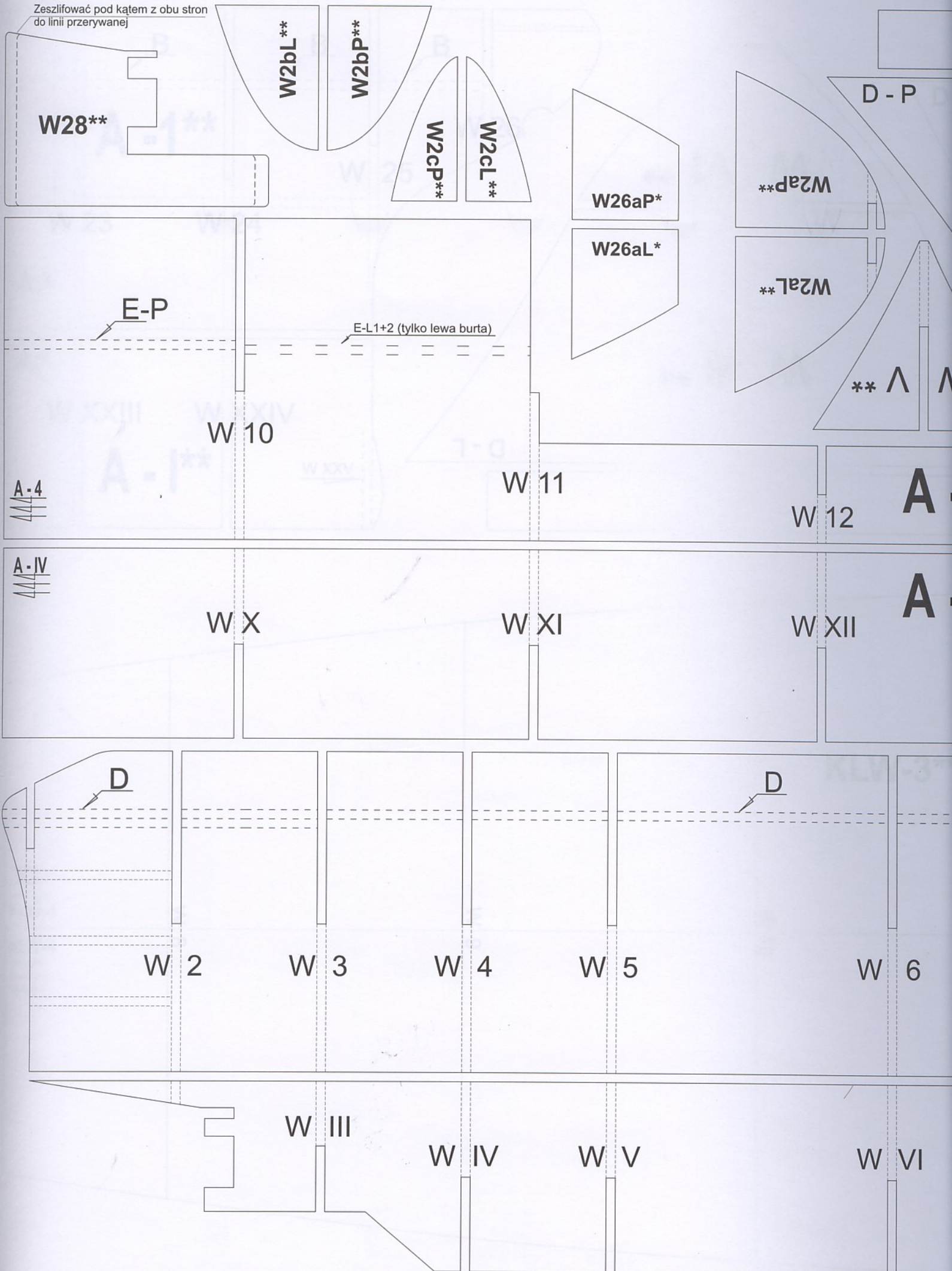

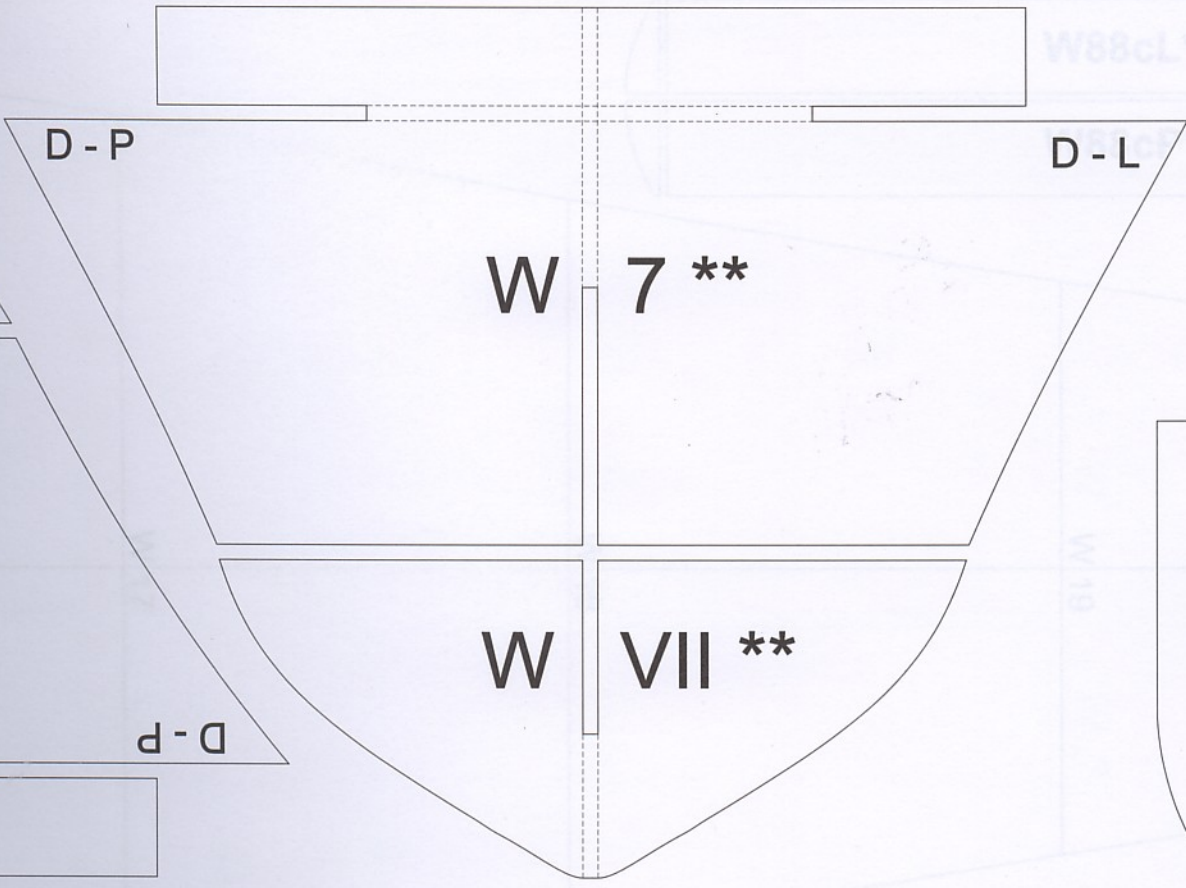

W-3\*\*

W 11

W 12

W 13

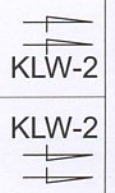

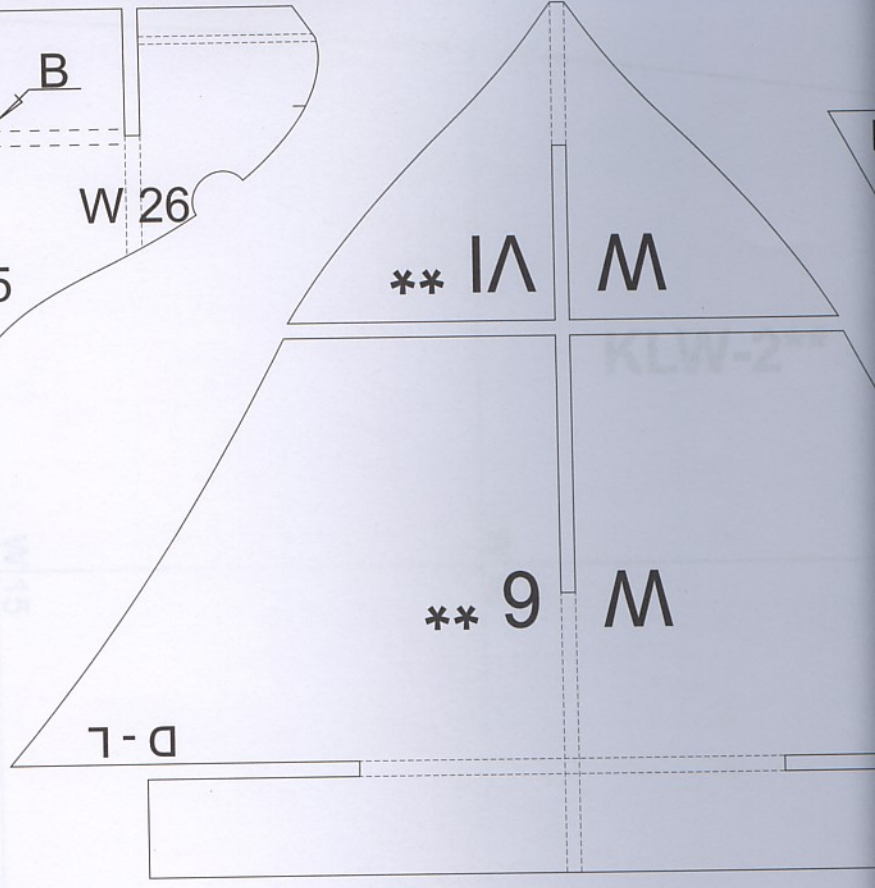
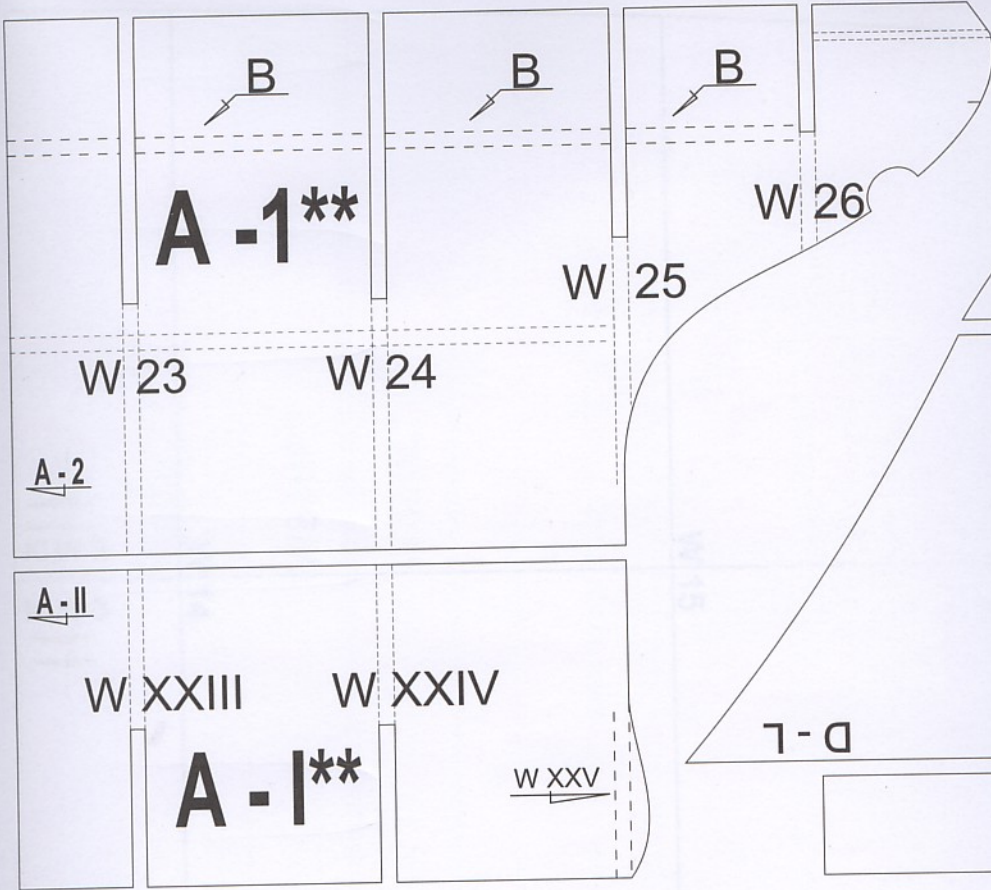

W88cL\*

W88cP\*

W 17

W 18

W 19

KLW-1

KLW-1

**P-POK1**

UWAGA-  
NIE PODKLEJAJĄC TEKSTURA

P-POK2

P-POK2

W 26

W 25

W 24

W 23

W 22

W 21

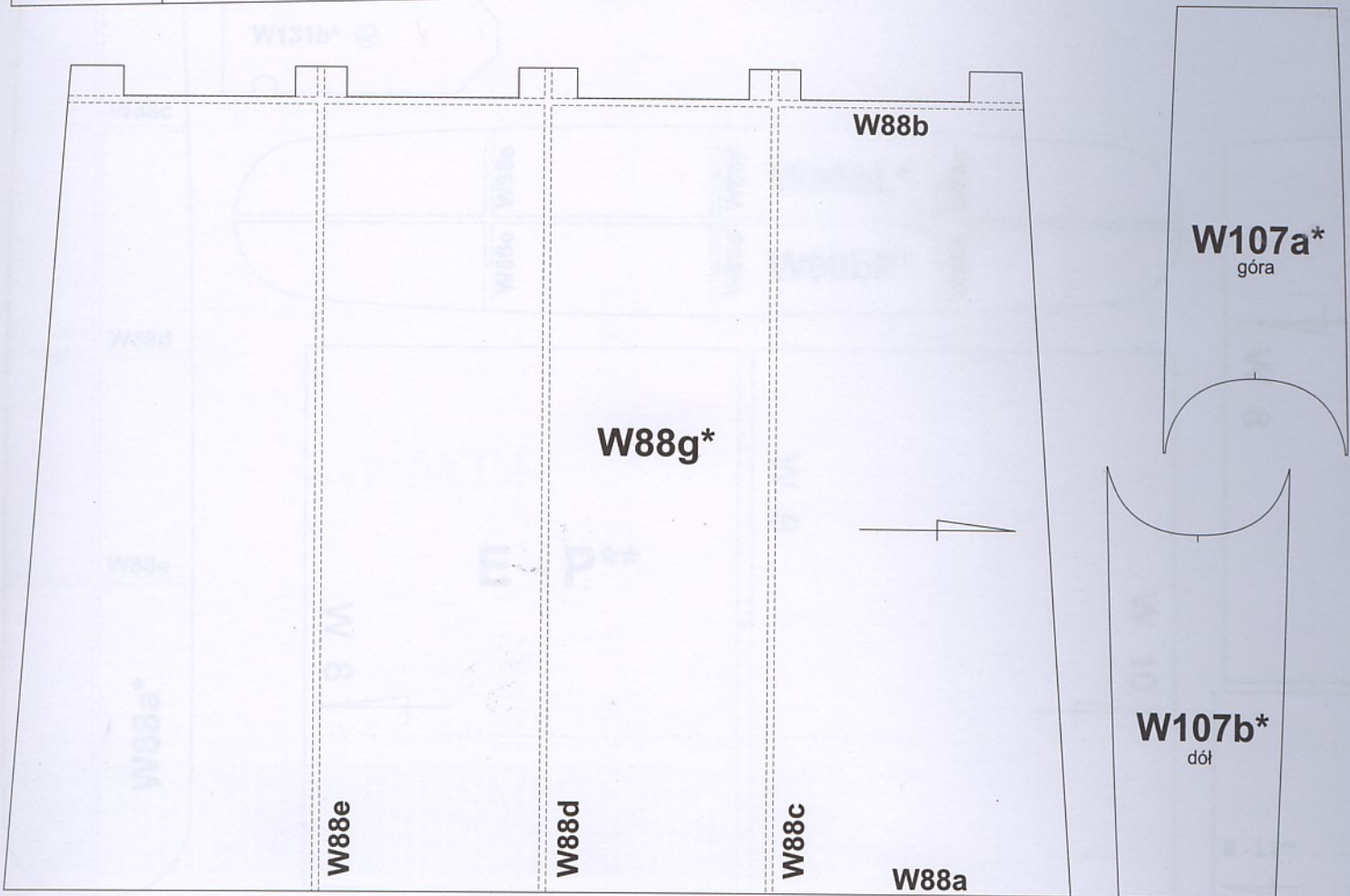

Zeszlić pod kątem od spodu do linii przerywanej

**D - L\*\***

W 5

W 6

W 7

W 8

**D - P\*\***

W 5

W 6

W 7

W 8

Zeszlić pod kątem od spodu do linii przerywanej

**E - L2\*\***

W 9

W 10

W 11

**E - L1\*\***

**E - L1\*\***

W 12

W 13

W 14

W 15

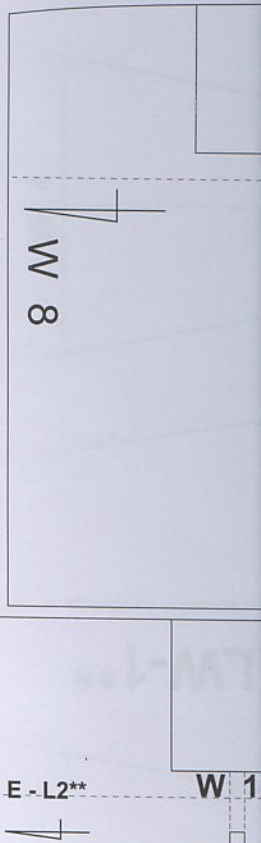
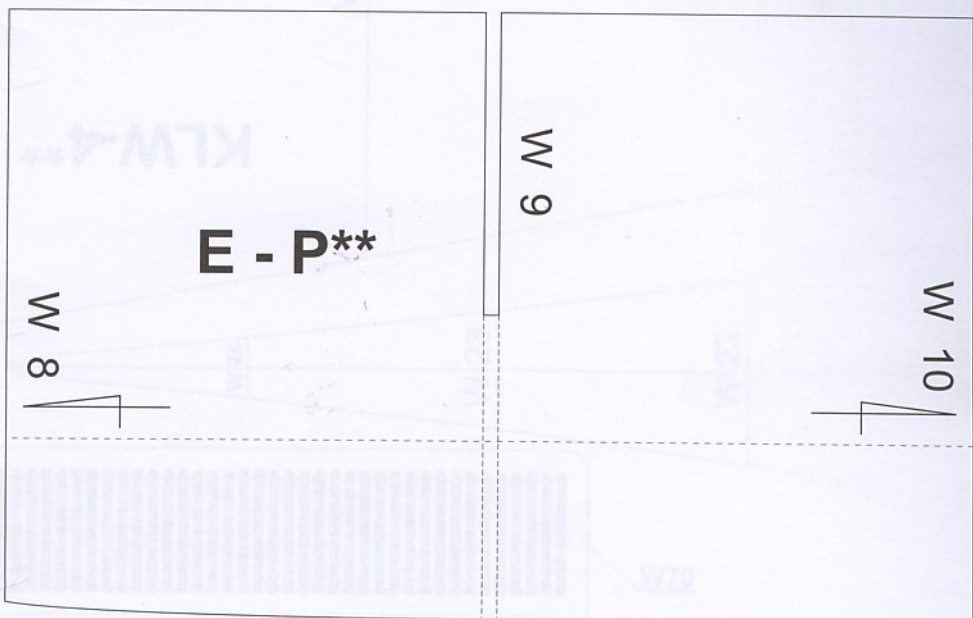
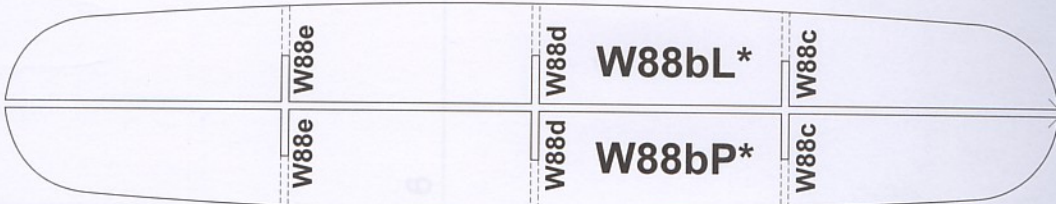
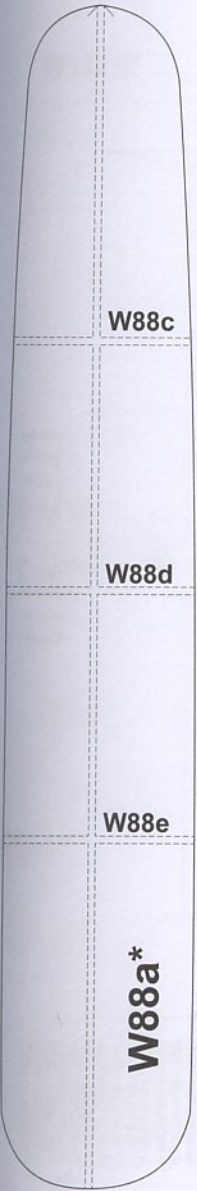
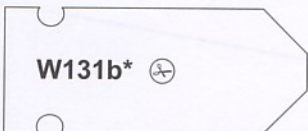
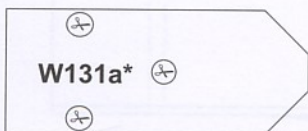
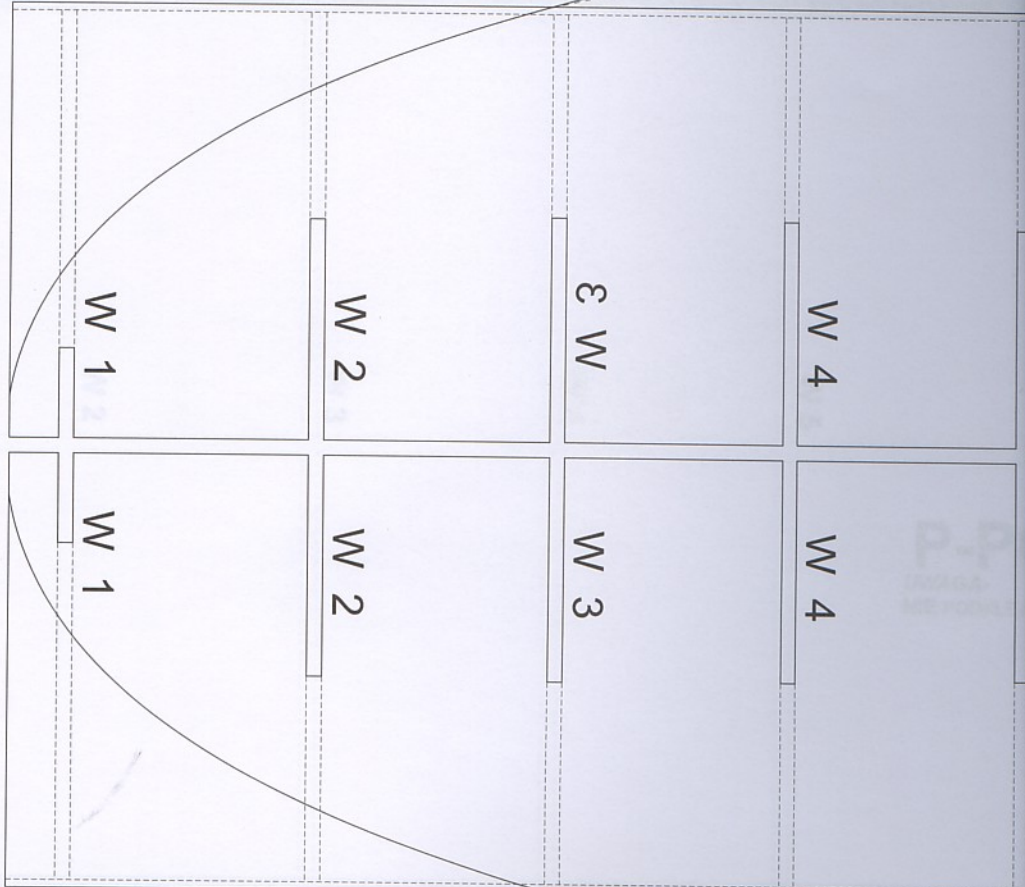
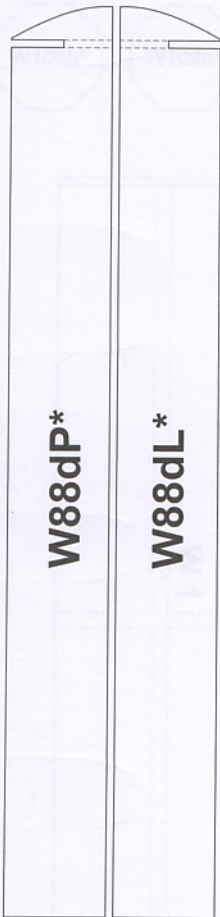
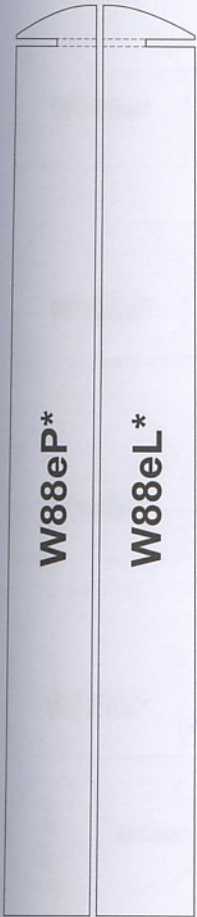



W165b\*

W165a\*

W165b\*

P-POK3



W 9

W 7

W 8

**P-POK4**

UWAGA-  
NIE PODKLEJAĆ TEKSTURĄ

P-POK3

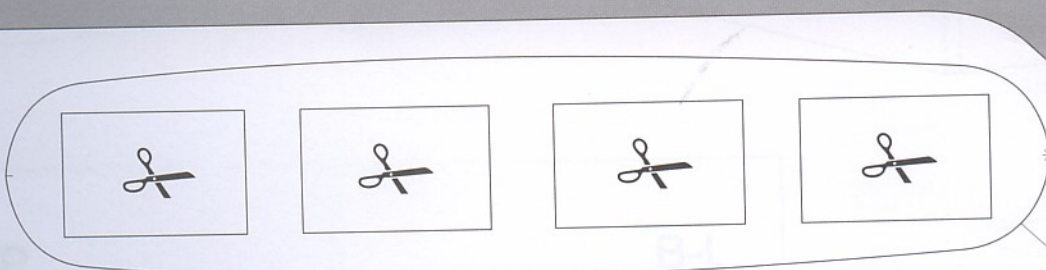

W88<sup>kart</sup>

W 3

W 2

**W 24 \*\***

B-P

B-L

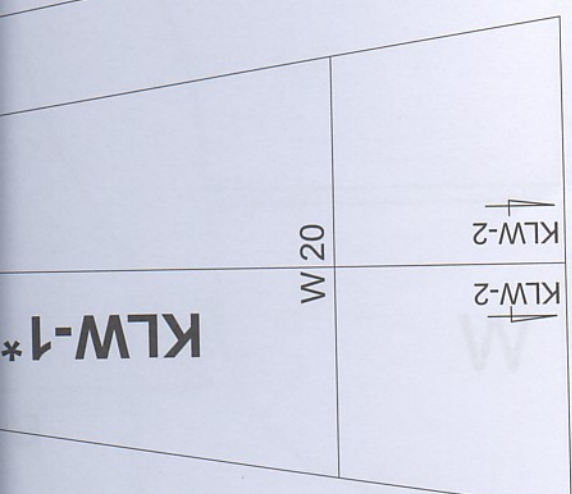

W 20

KWLW-2

KWLW-2

KWLW-1\*

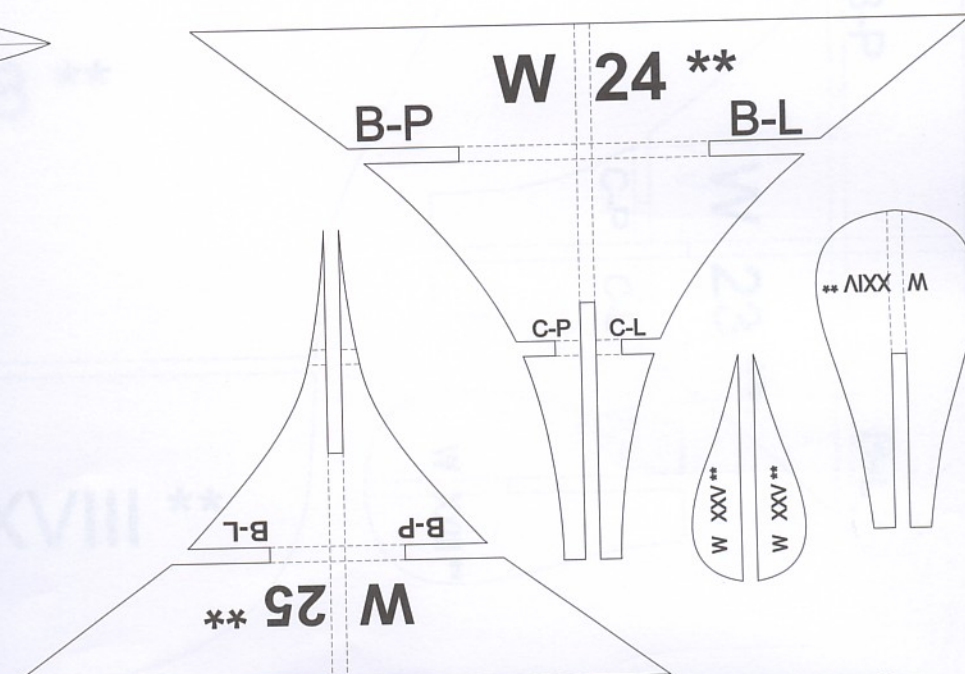

**W 25 \*\***

W XXIV \*\*

W XXX \*\*

W XXX \*\*

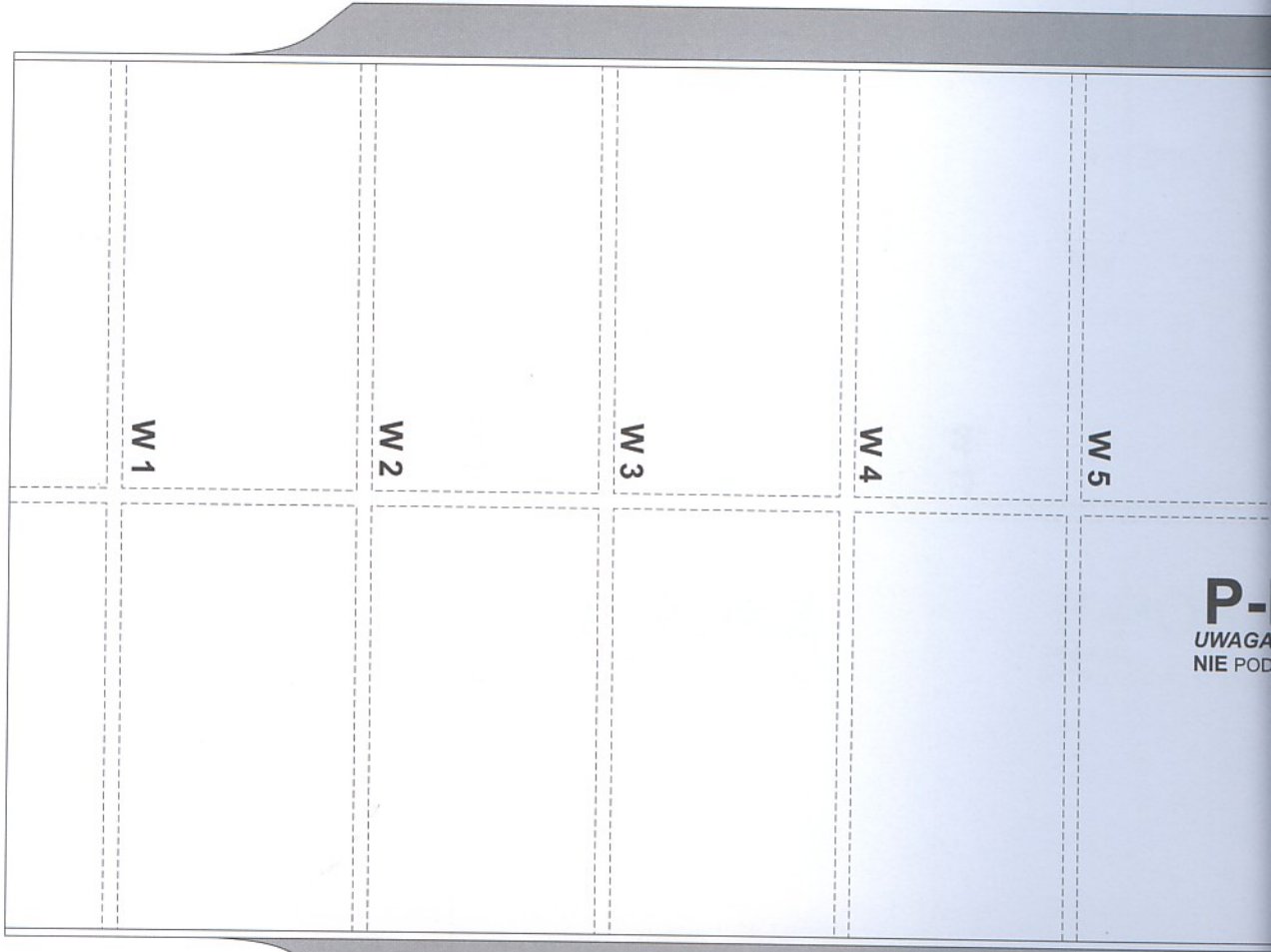
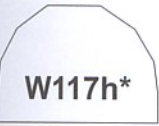
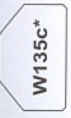
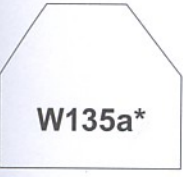
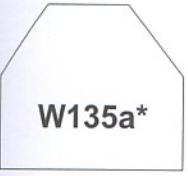
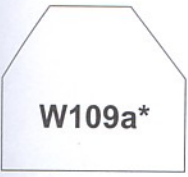
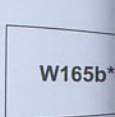
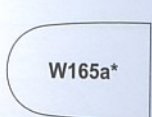
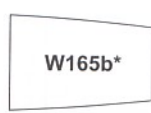
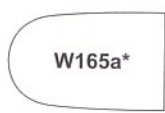
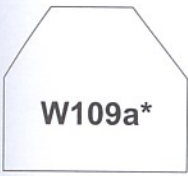

**P-**  
 UWAGA  
 NIE POD

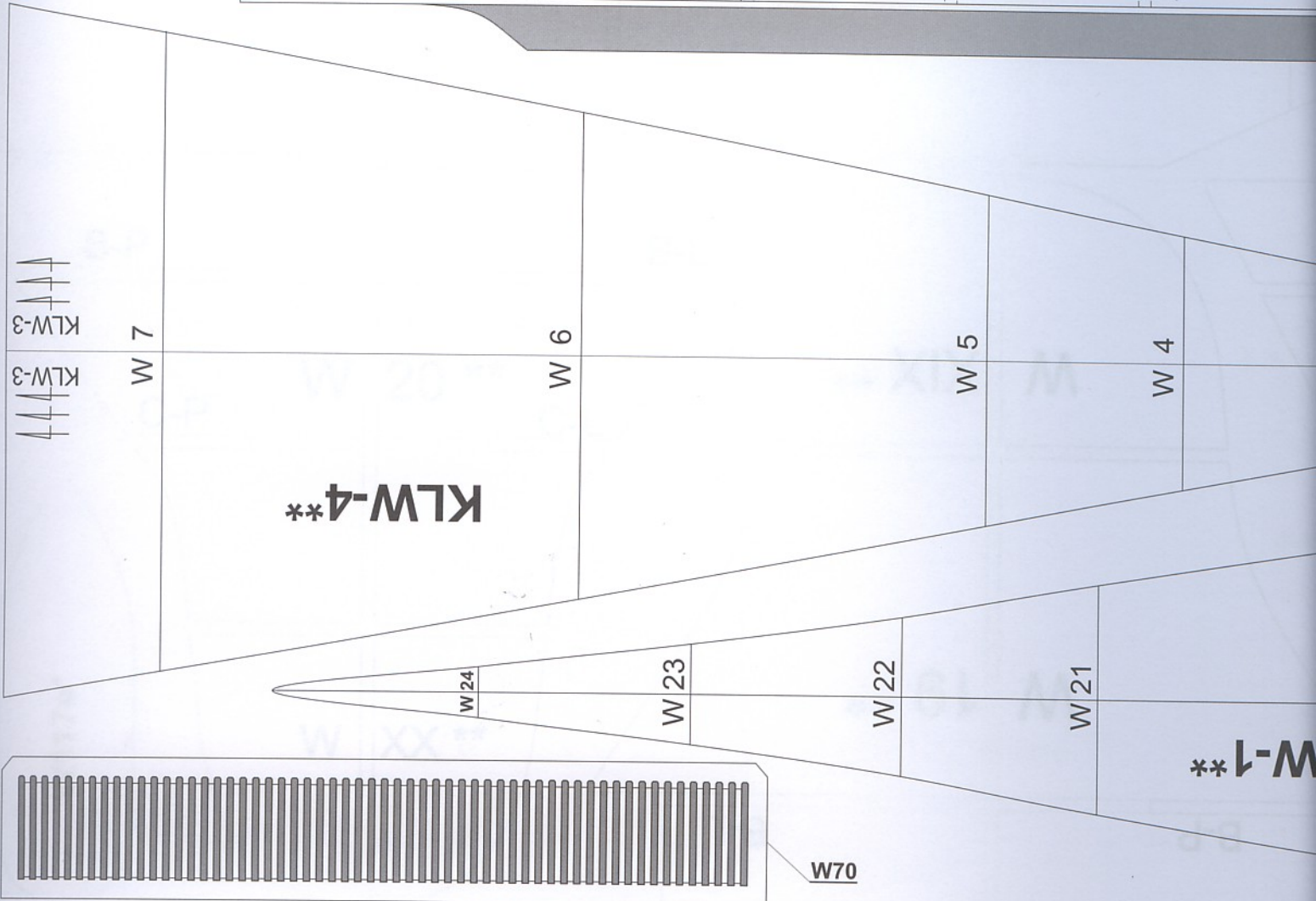

**W-1\*\***

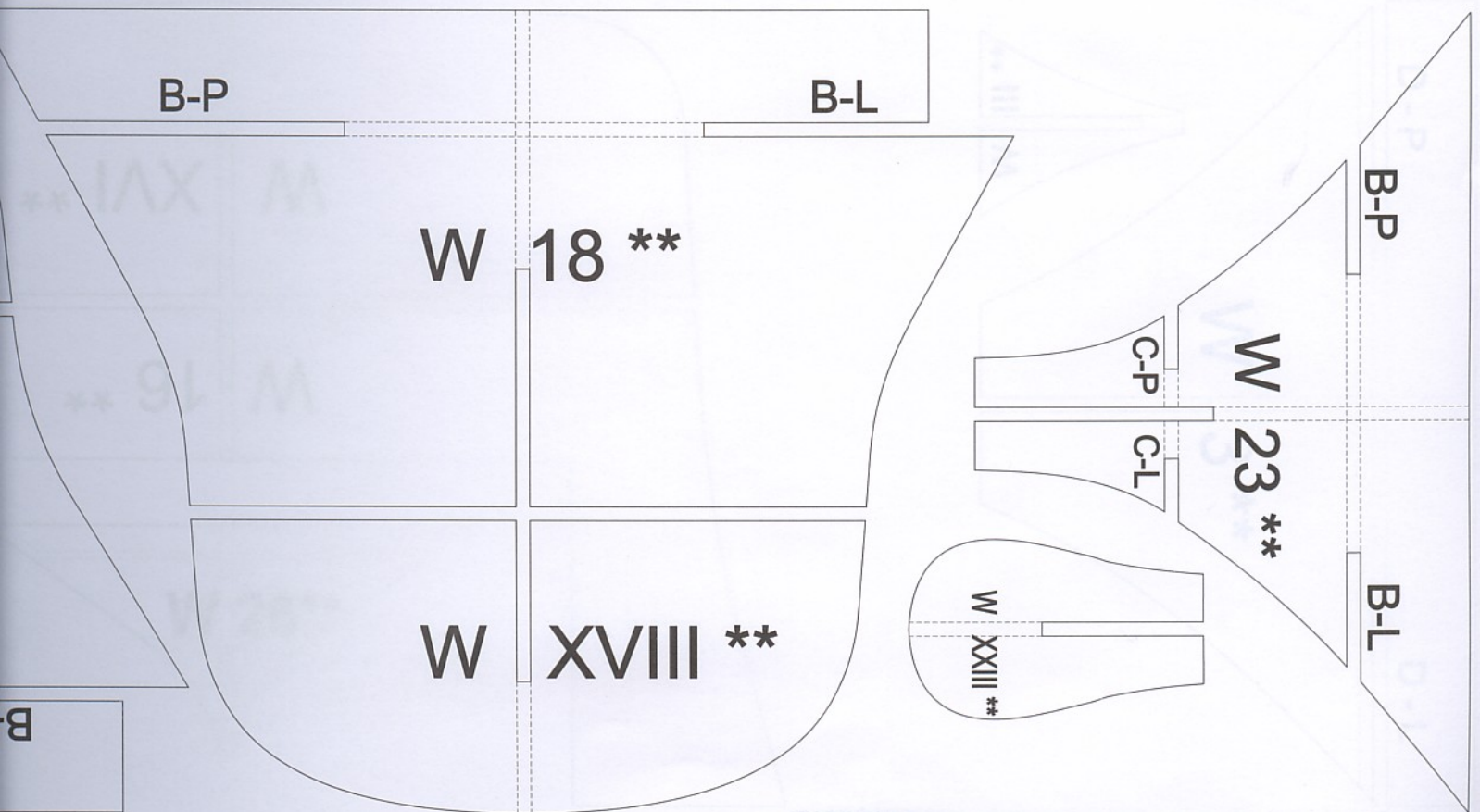
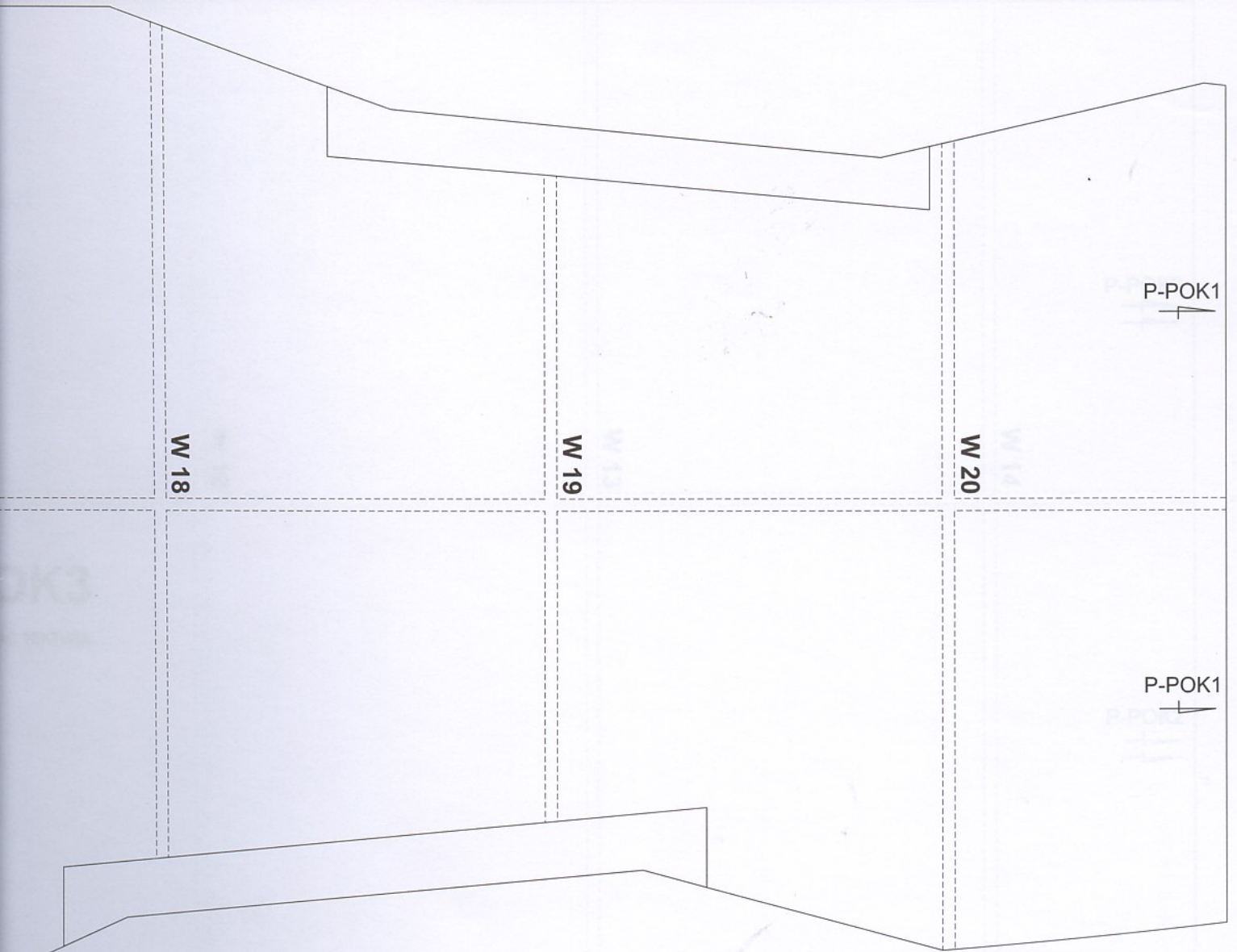

P-POK3



W 15

W 16

W 17

**P-POK2**

UWAGA-  
NIE PODKLEJAĆ TEKSTURA

P-POK3



B-P

B-L

W 20 \*\*

C-P

C-L

\*\* XIX M

\*\* 19 W

W117e\*

W XX \*\*

B-L

B-P

D-2P bis

D-2L bis

P-POK2



W 14

W 13

W 12

K3

EKTURA

P-POK2



D-P

D-L

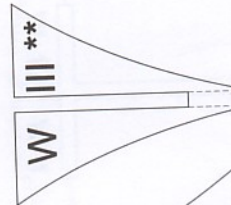

W

3 \*\*

W XVI \*\*

W 16 \*\*

W 26 \*\*

W 15 \*\*

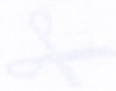

P-POK4



W 9

W 10

W 11

W 13 \*\*

W 13 \*\*



P-POK4



**P-POK3**

UWAGA-  
NIE PODKLEJAĆ TEKSTURĄ

B-P

B-L

W 17 \*\*

W XIII \*\*

\*\* l

\*\*

W XVII \*\*

W 3

W 4

W 5

W 6

W 7

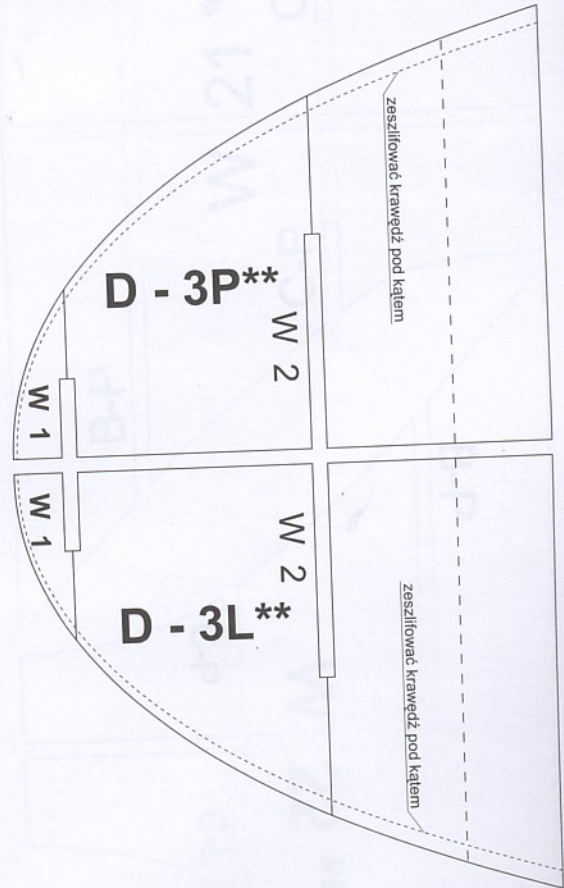
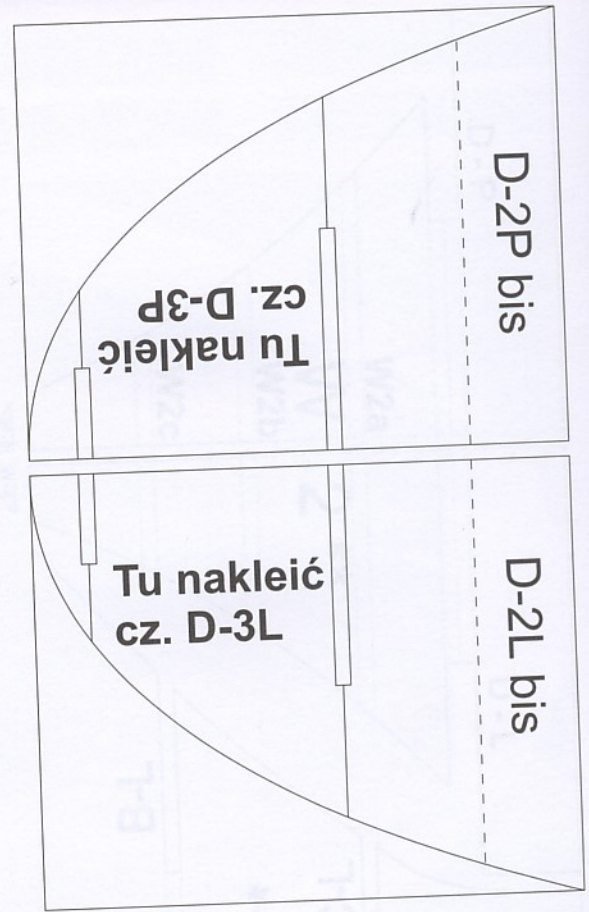
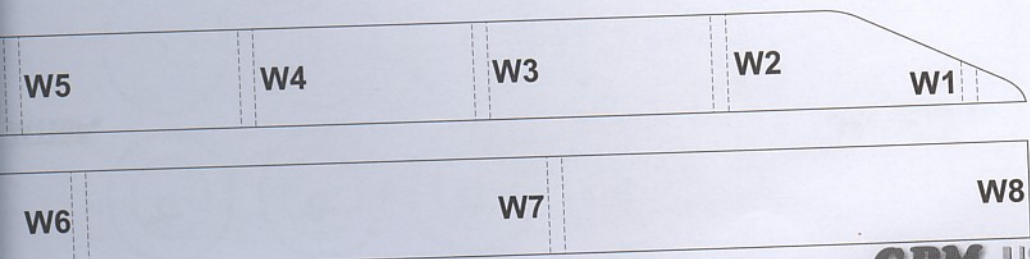
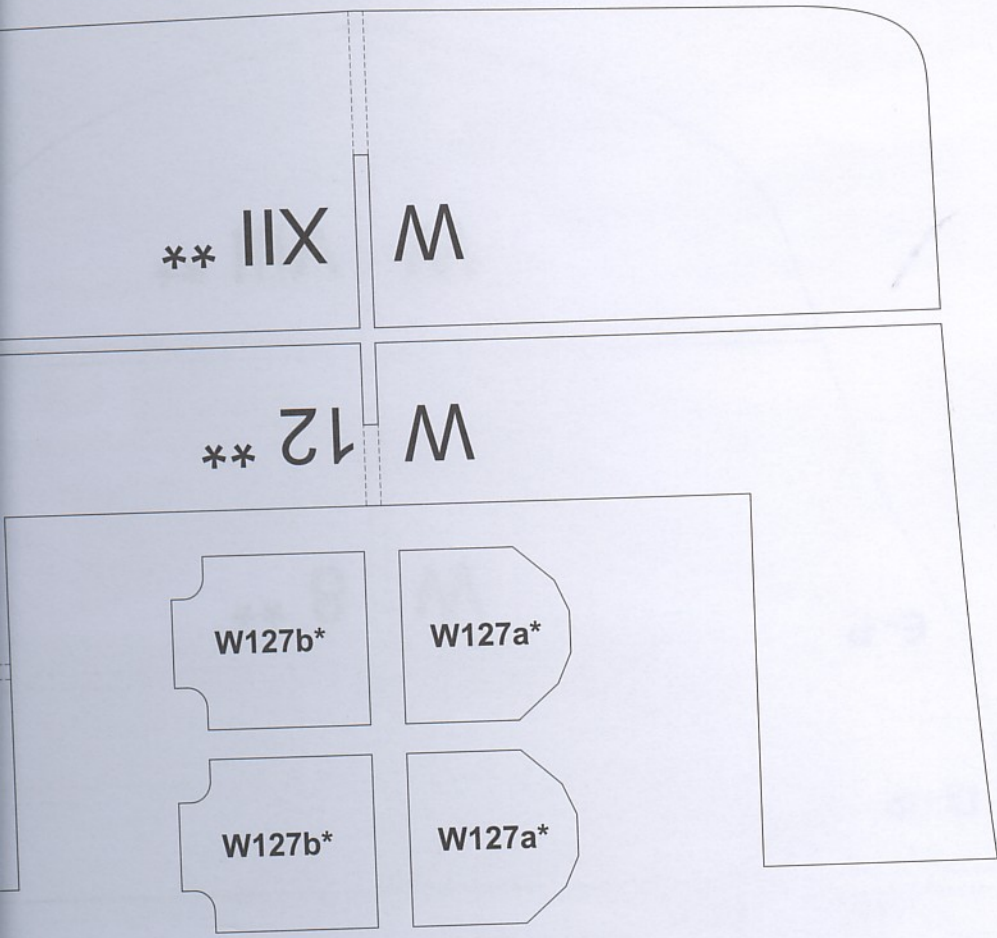
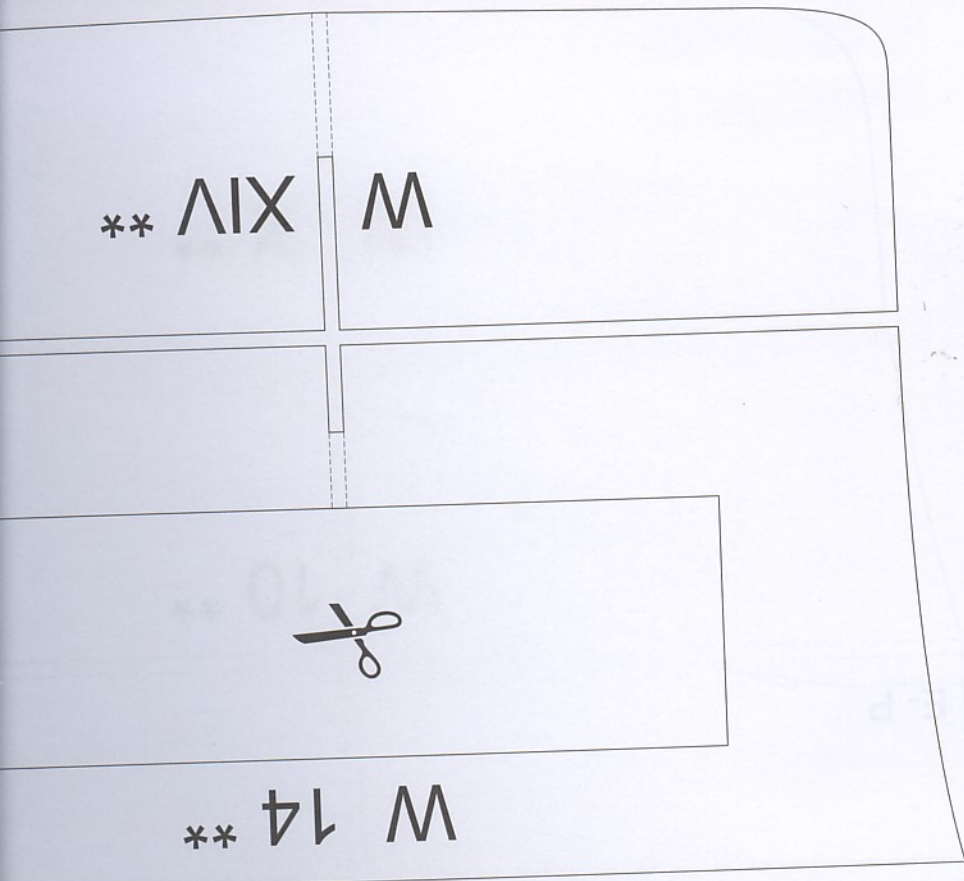

W 15 \*\*



E-1L

W XV \*\*

E-1L

W 13 \*\*



E-1L

W XIII \*\*

E-1L

W8

W7

W6

WG-P\*

W5

W1

W2

W3

W4

W5

WG-L\*

W6



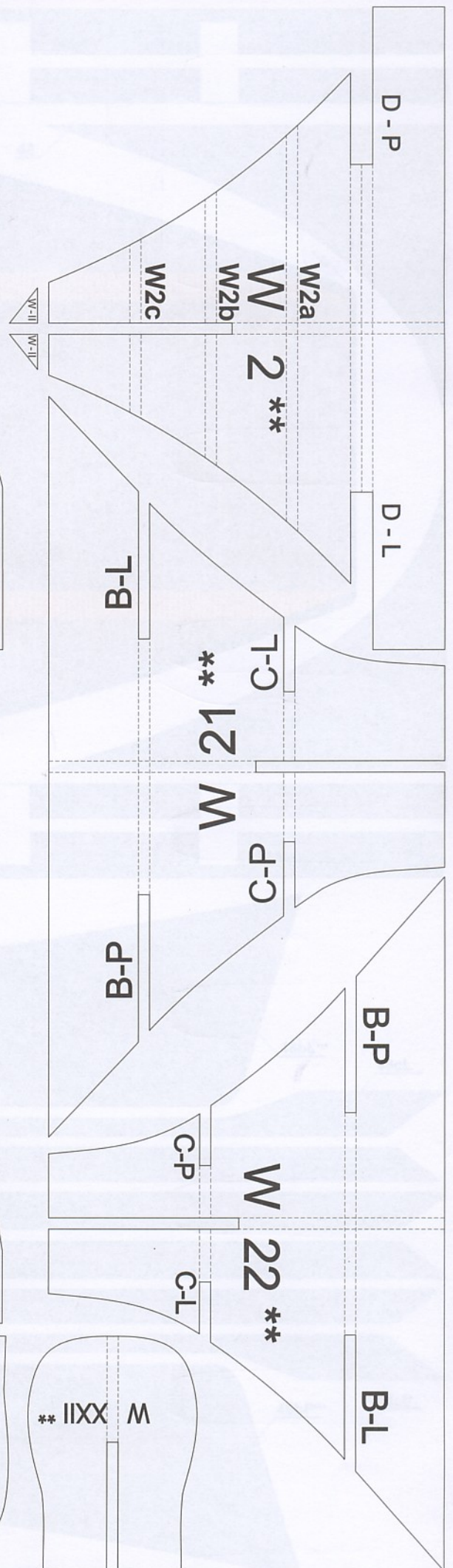
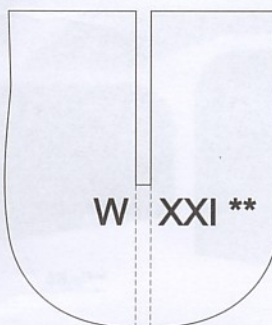
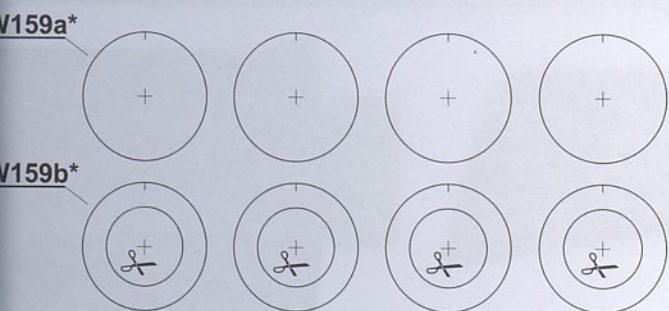
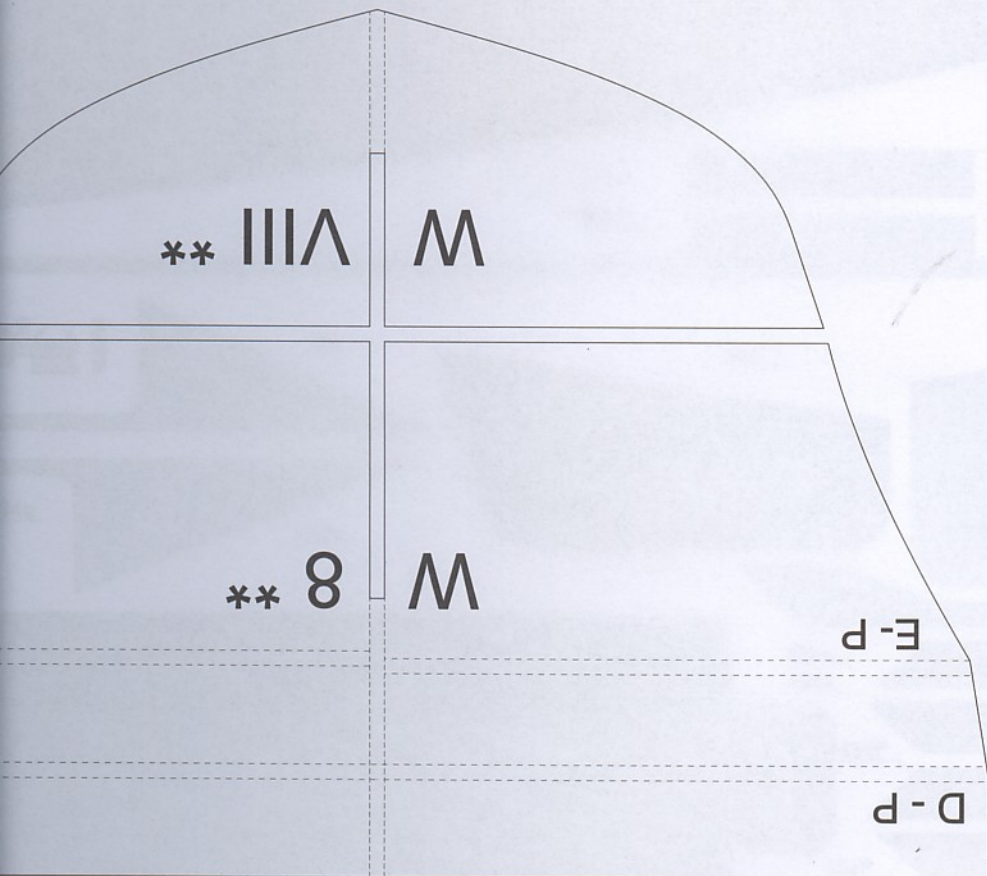
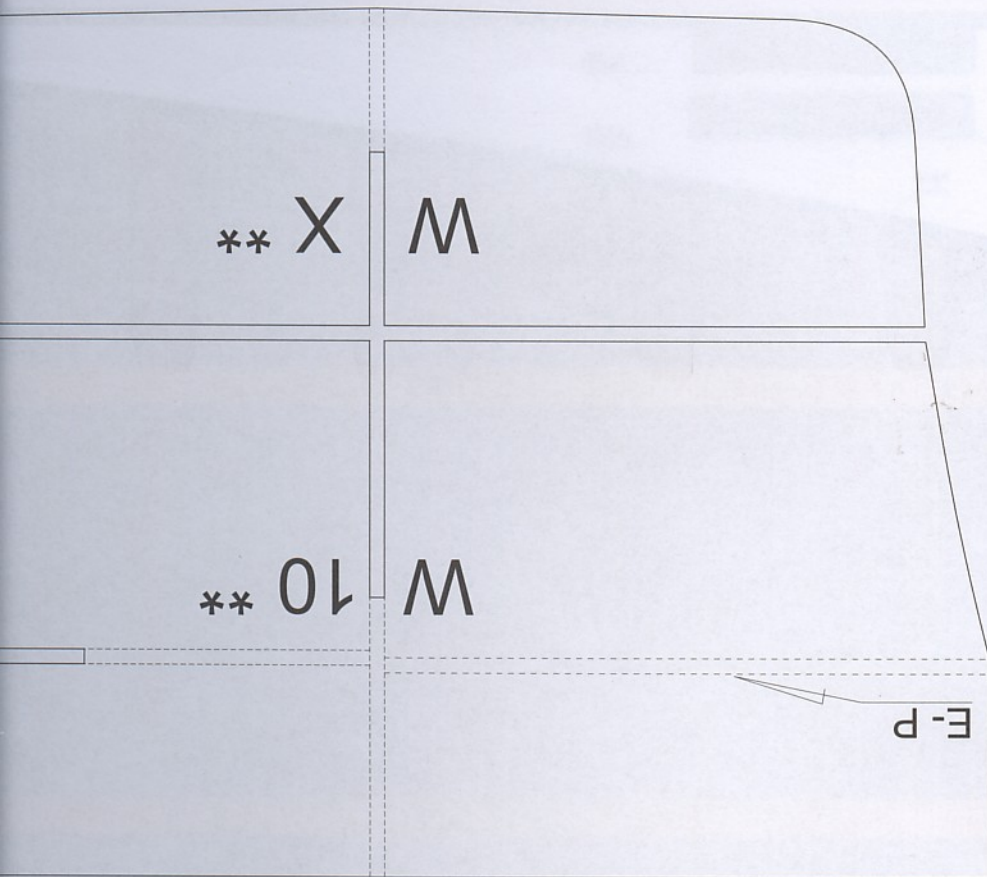

W 11 \*\*

E-2L

W XI \*\*

E-2L

E-P

W 9 \*\*

E-2L

W XI \*\*

E-2L

D-L

W 1 \*\*

W159c\*

W159a\*

W159b\*

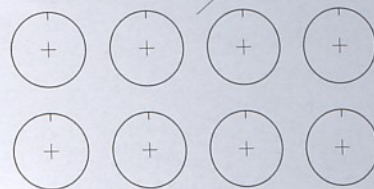

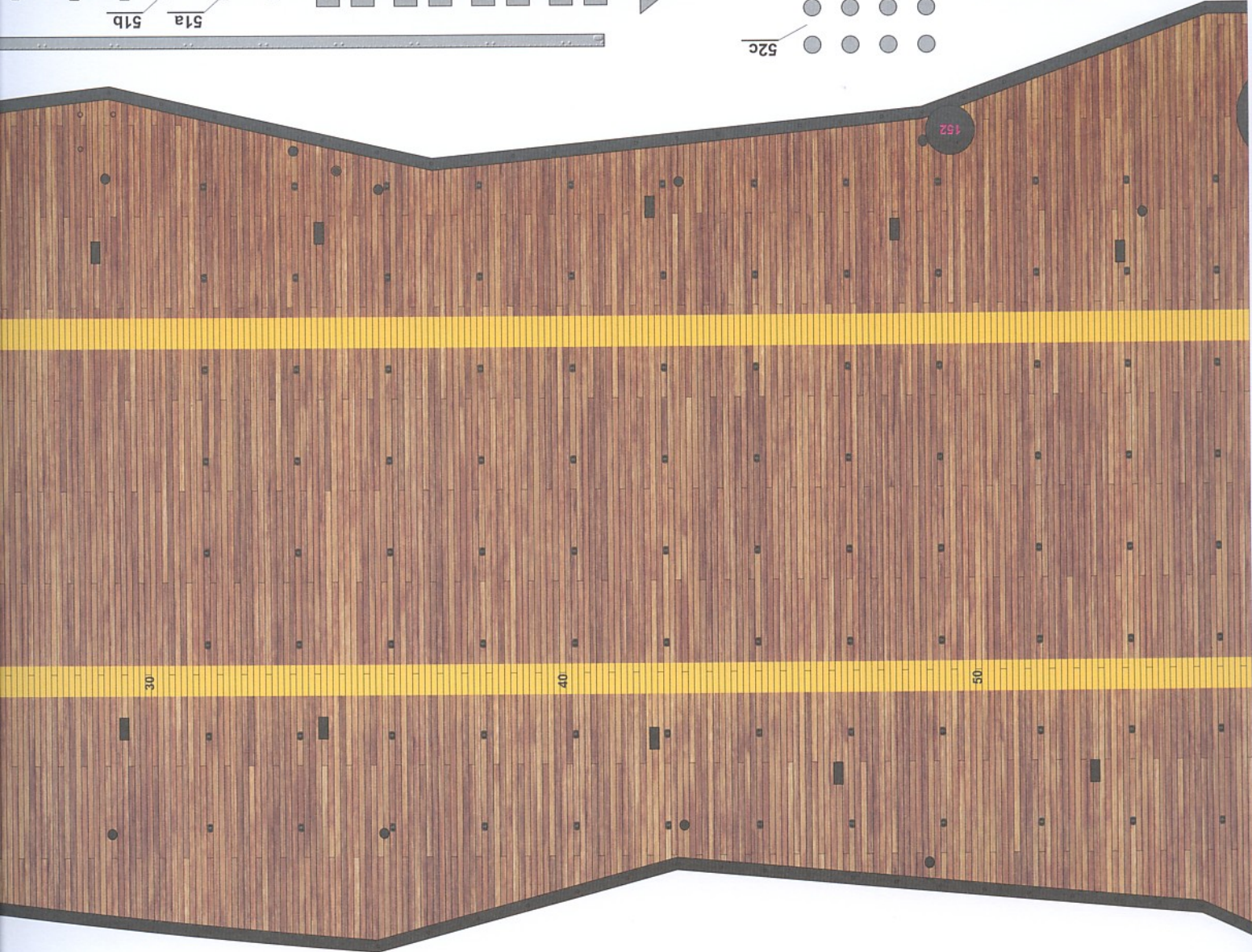
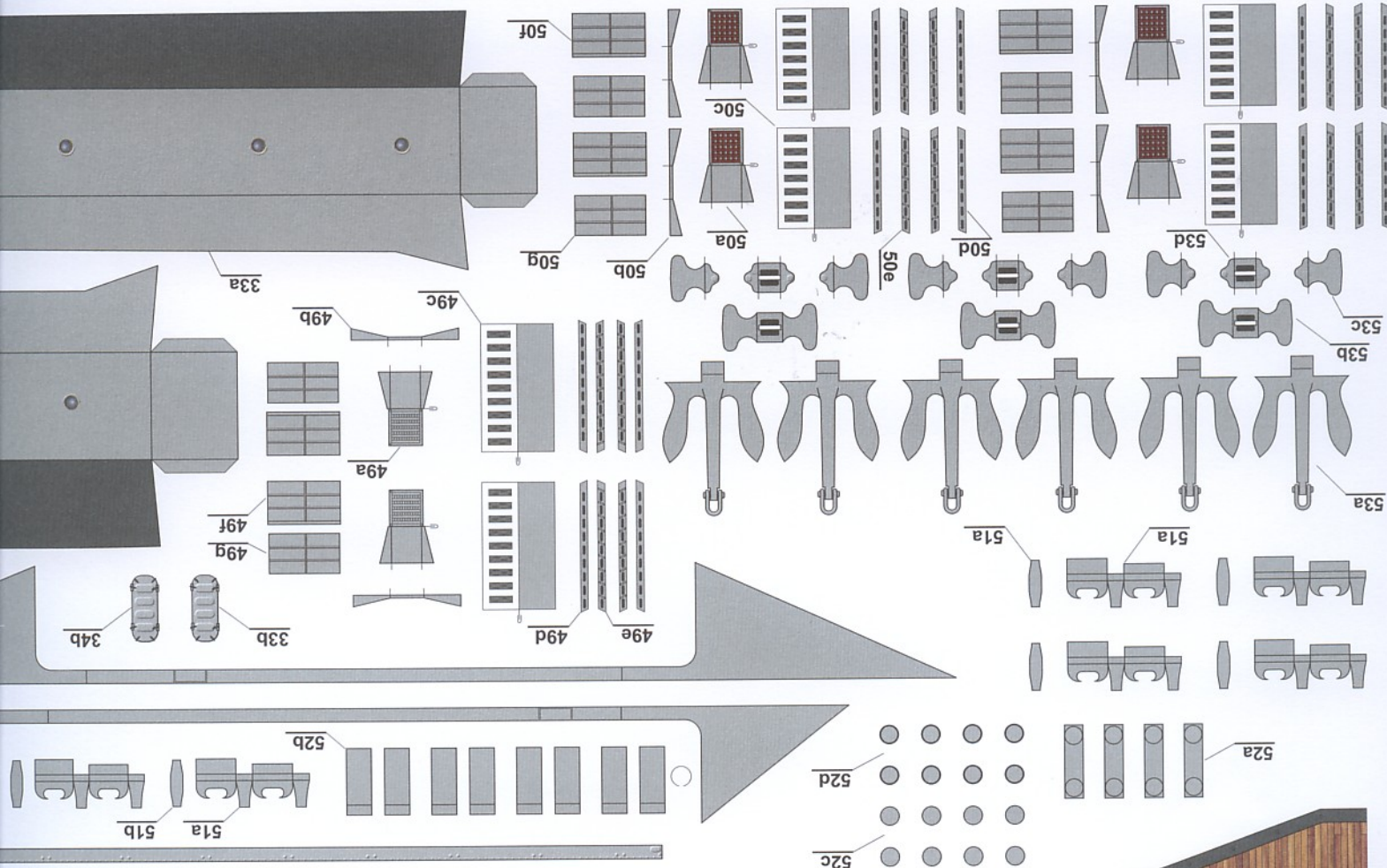

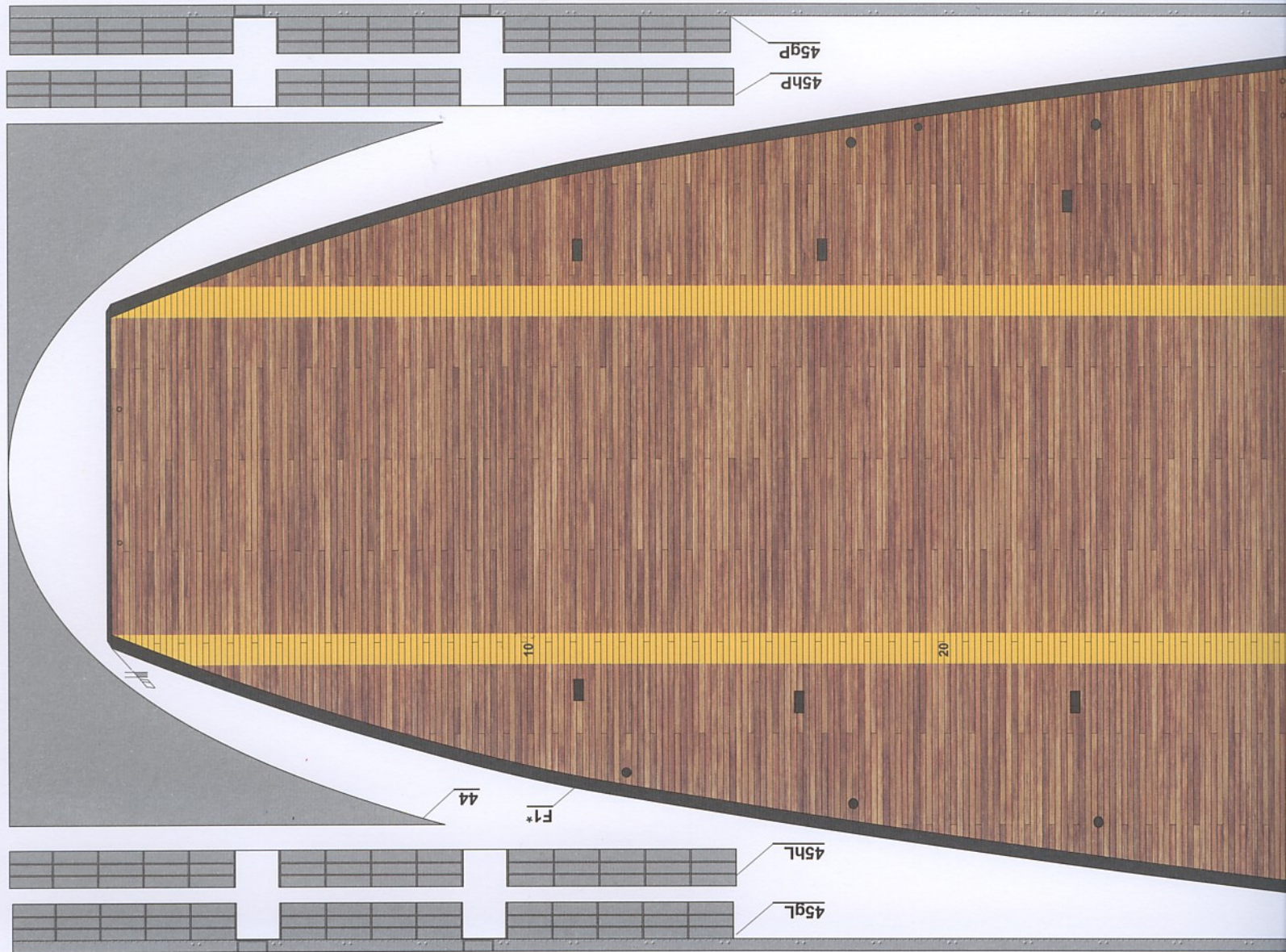
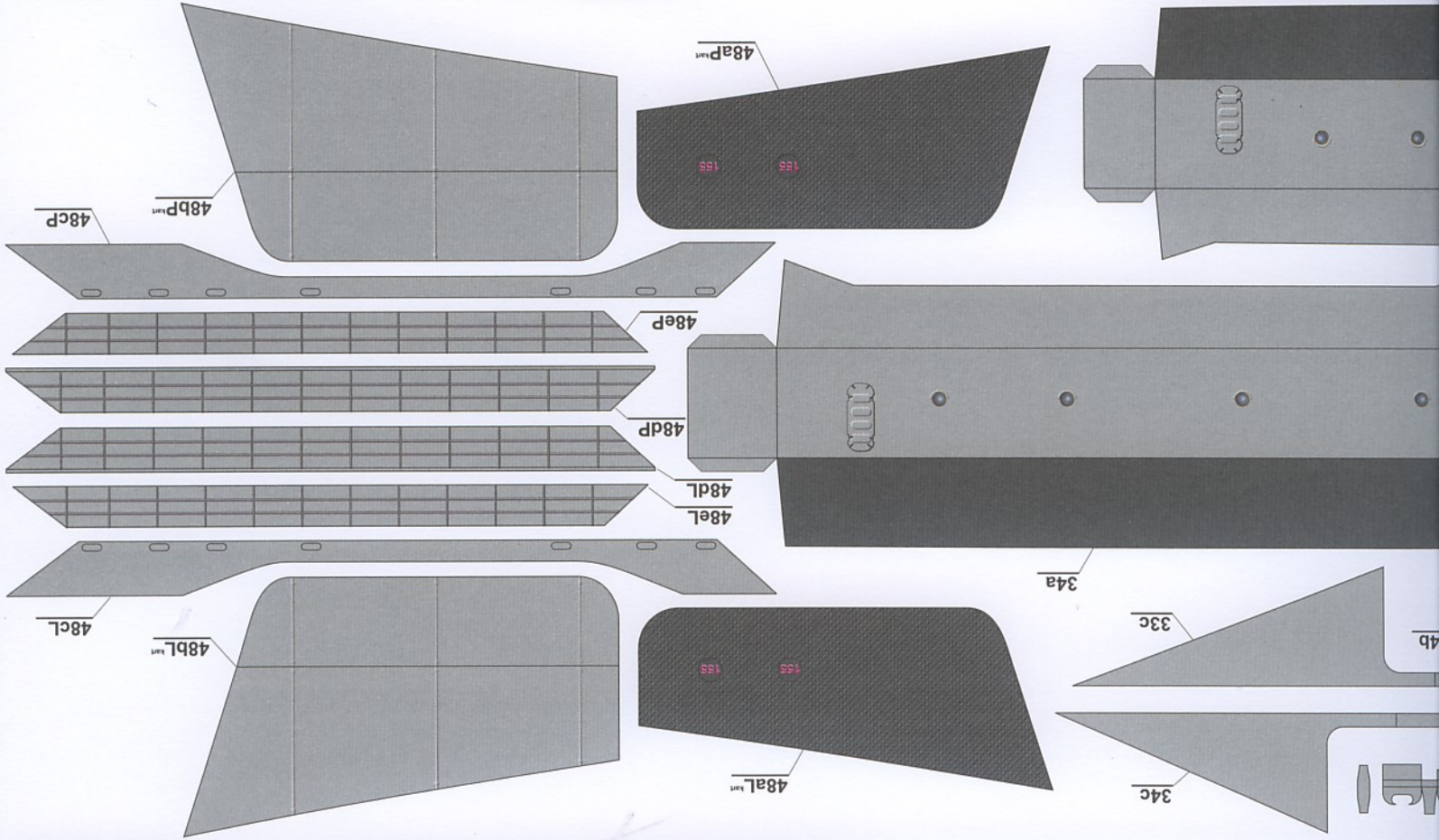

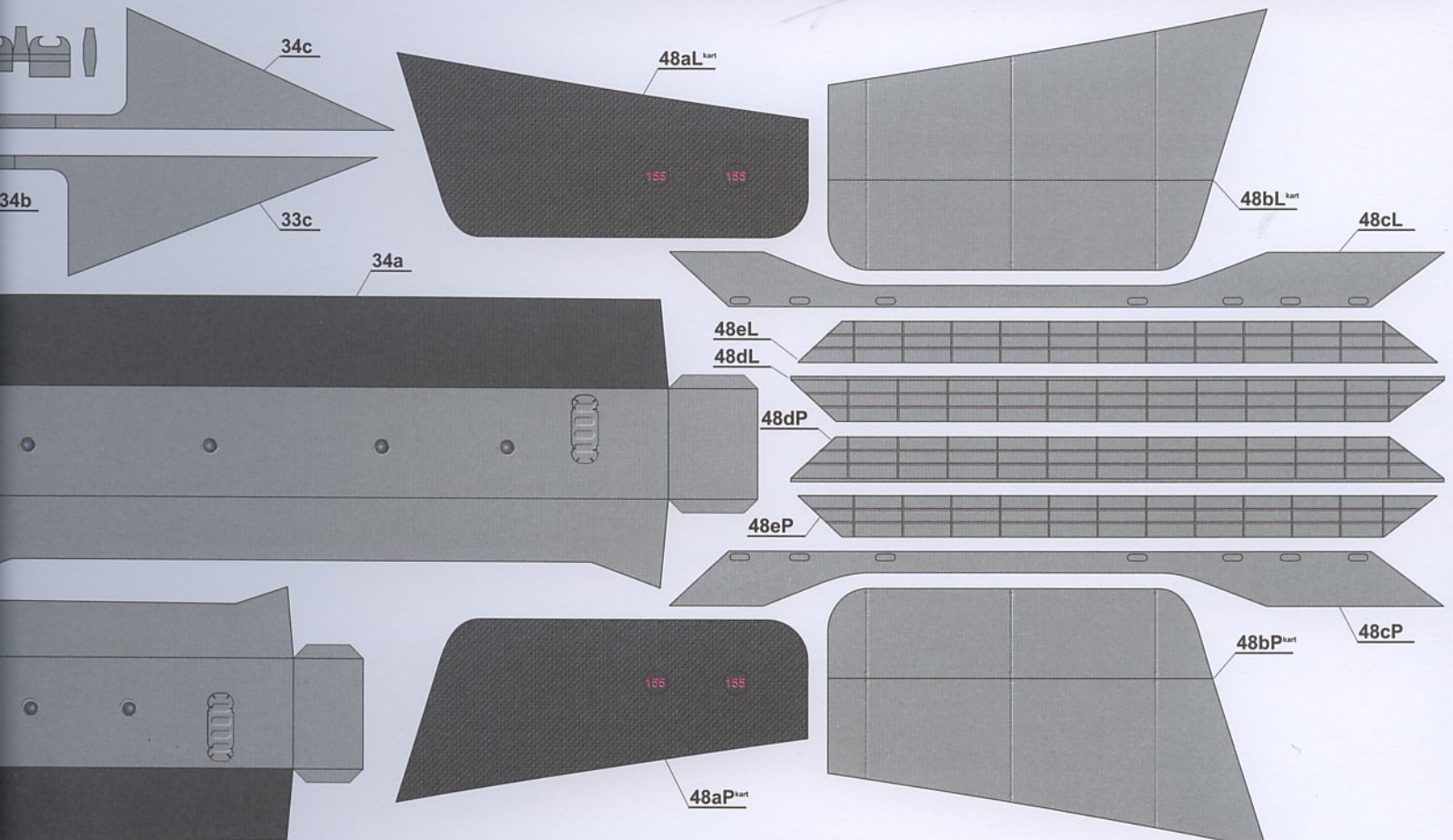
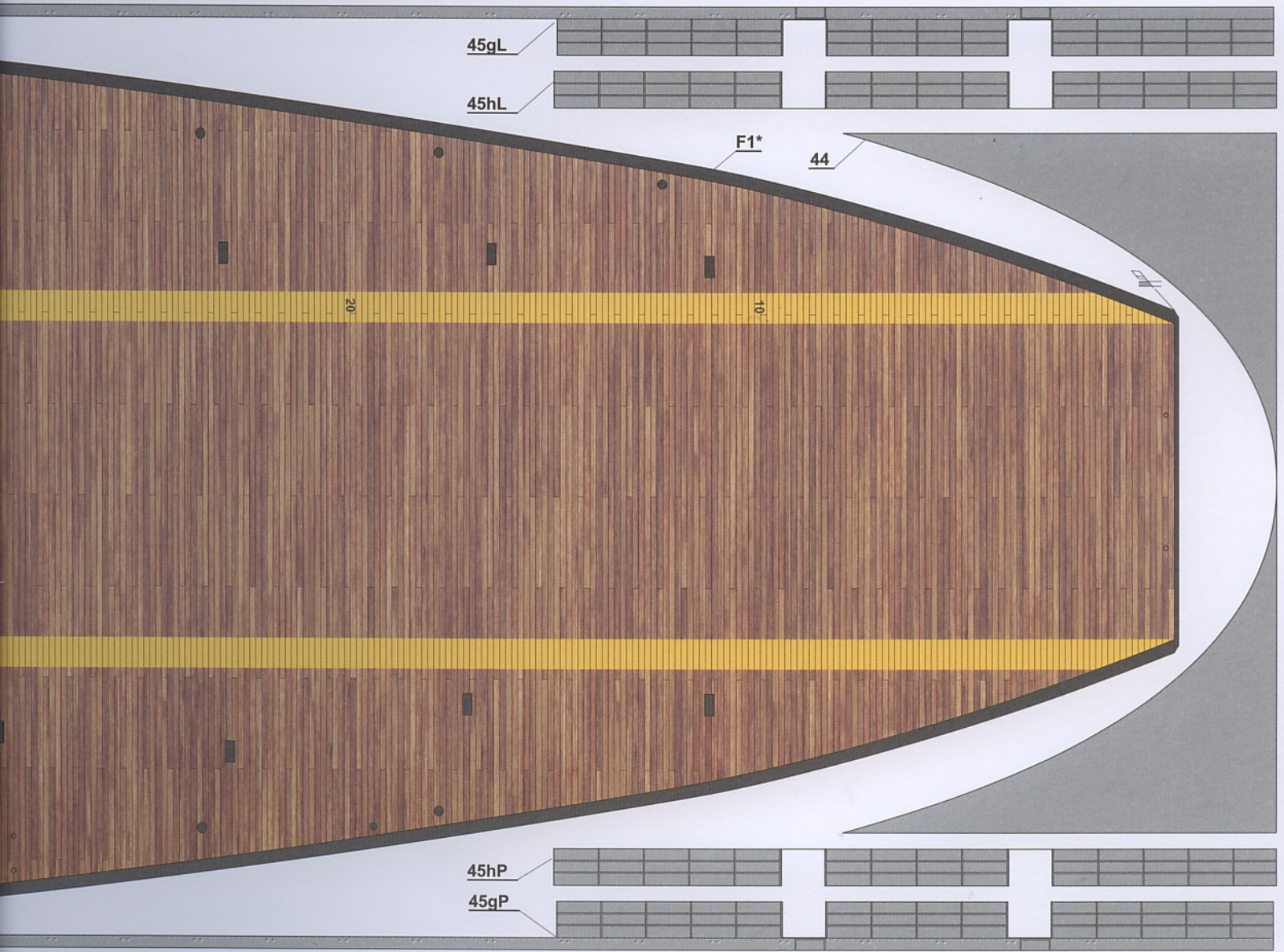

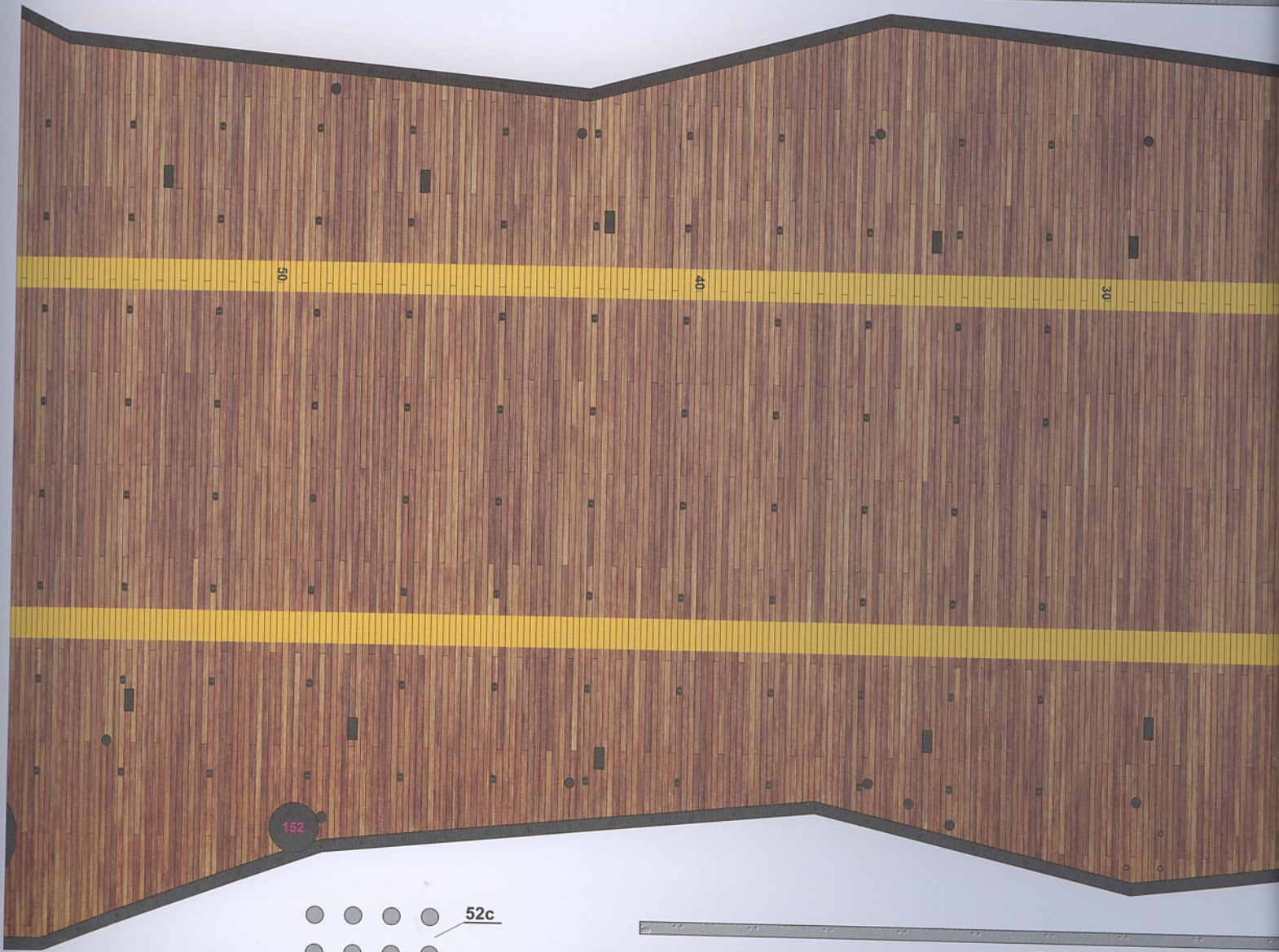

152

50

40

30

52a

52c

52d

51a

51b

52b

51a

51a

53a

53b

53c

53d

50d

50e

50a

50c

50b

50g

50f

49e

49d

33b

34b

49g

49f

49a

49b

49c

33a

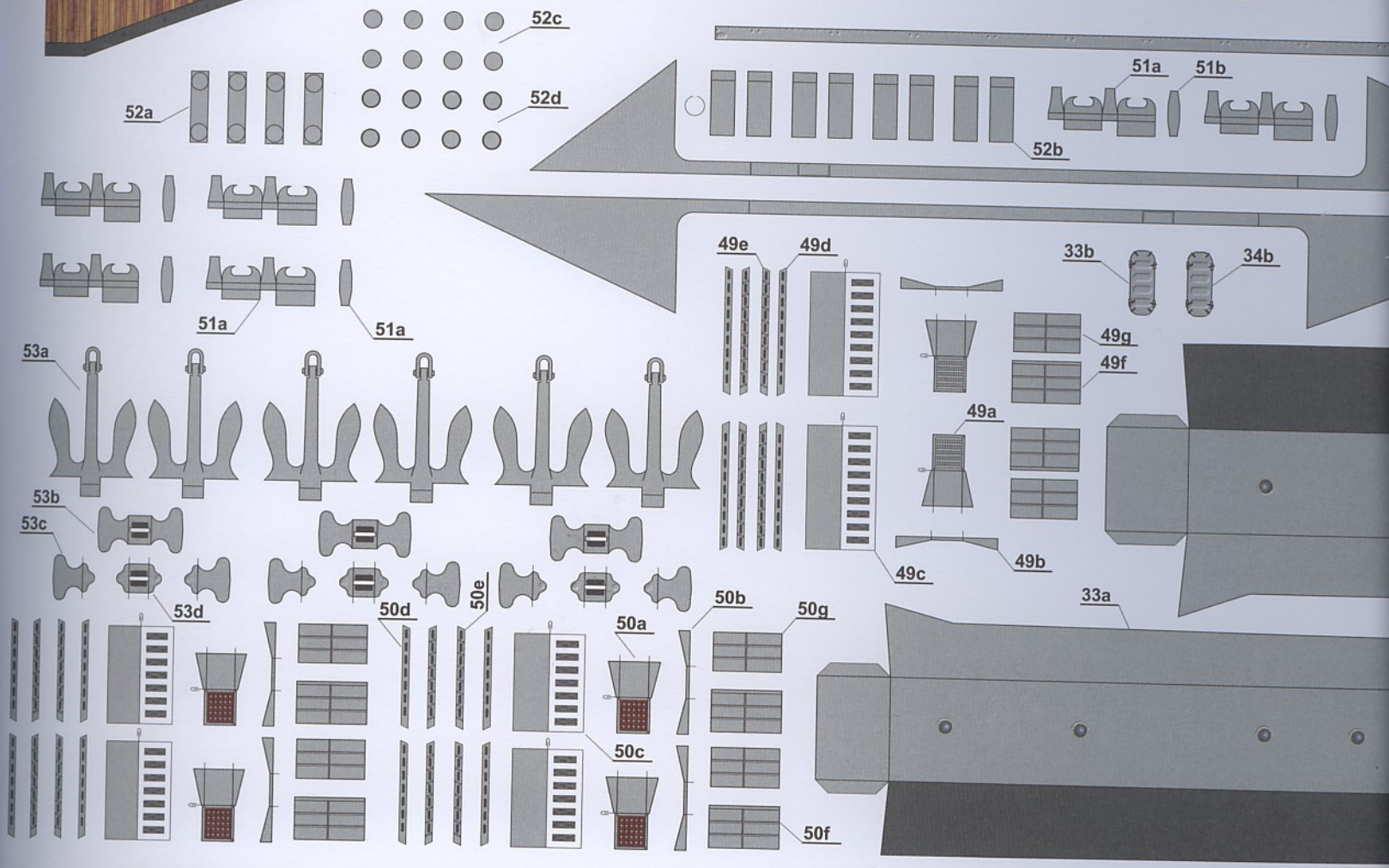

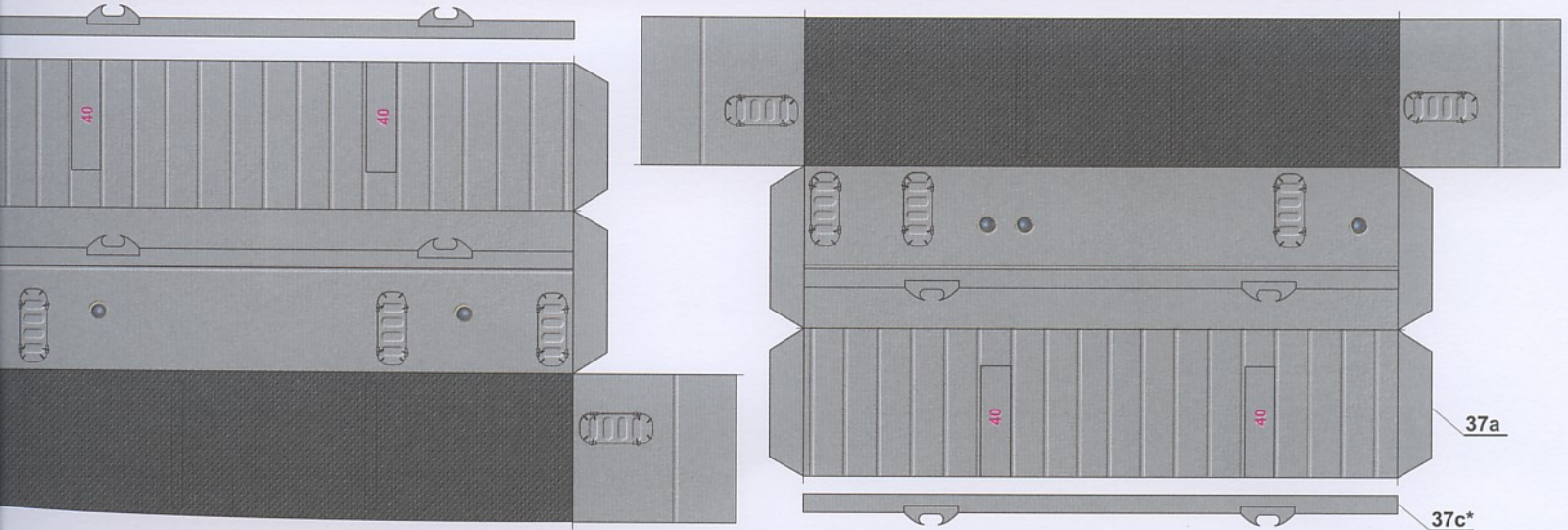
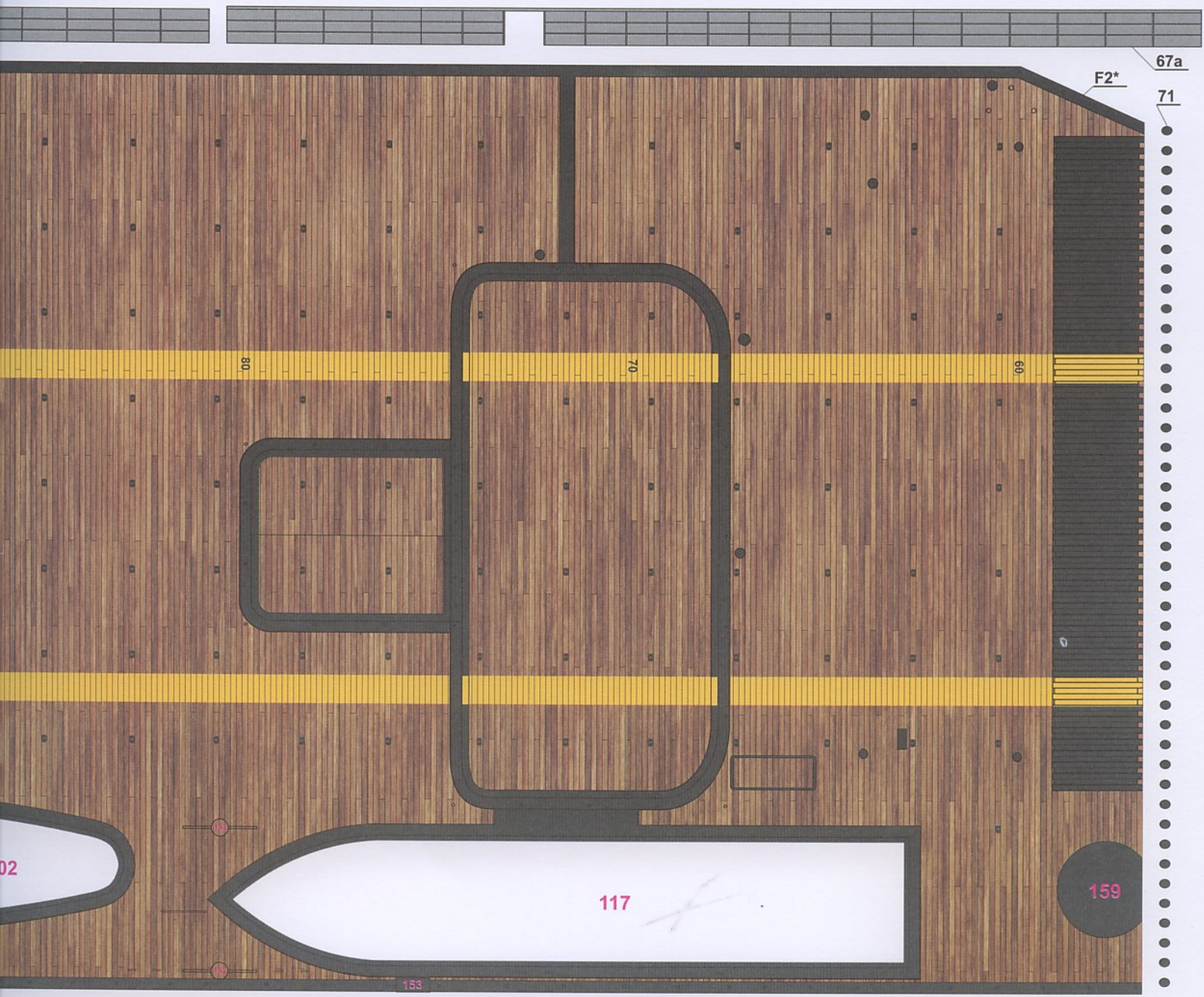



173

67b



172

174

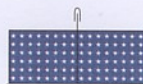

66b

66a

47j

70

47k 47h

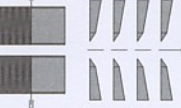

47g



47f\*

ściąć pod kątem, do linii przerywanej



47e\*

47a

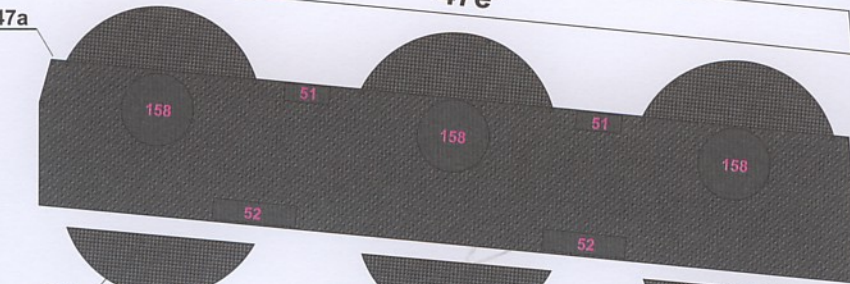

47d

47c

46b

47b

46d

46c

46b

47b

65a

65b

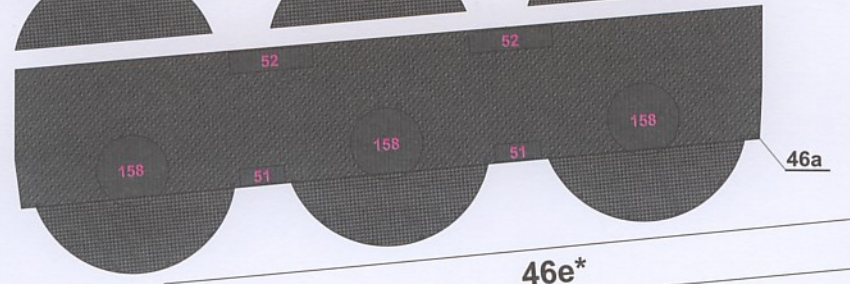
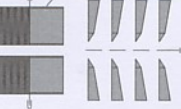

46d

46c

46b

46a

65d

65c

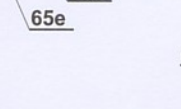

65e

46e\*



46f\*

ściąć pod kątem, do linii przerywanej

46g



46h

46j



46k

154b

154c

154d

153a

153b

154a

69a

68b

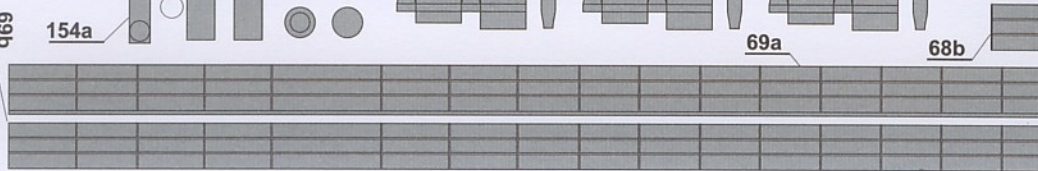

37d

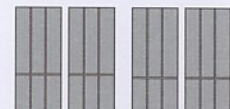

37e

36e

68a

36a



102

36c\*

36d

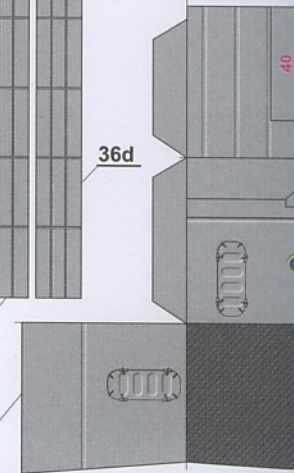

40



64b

63

F3\*

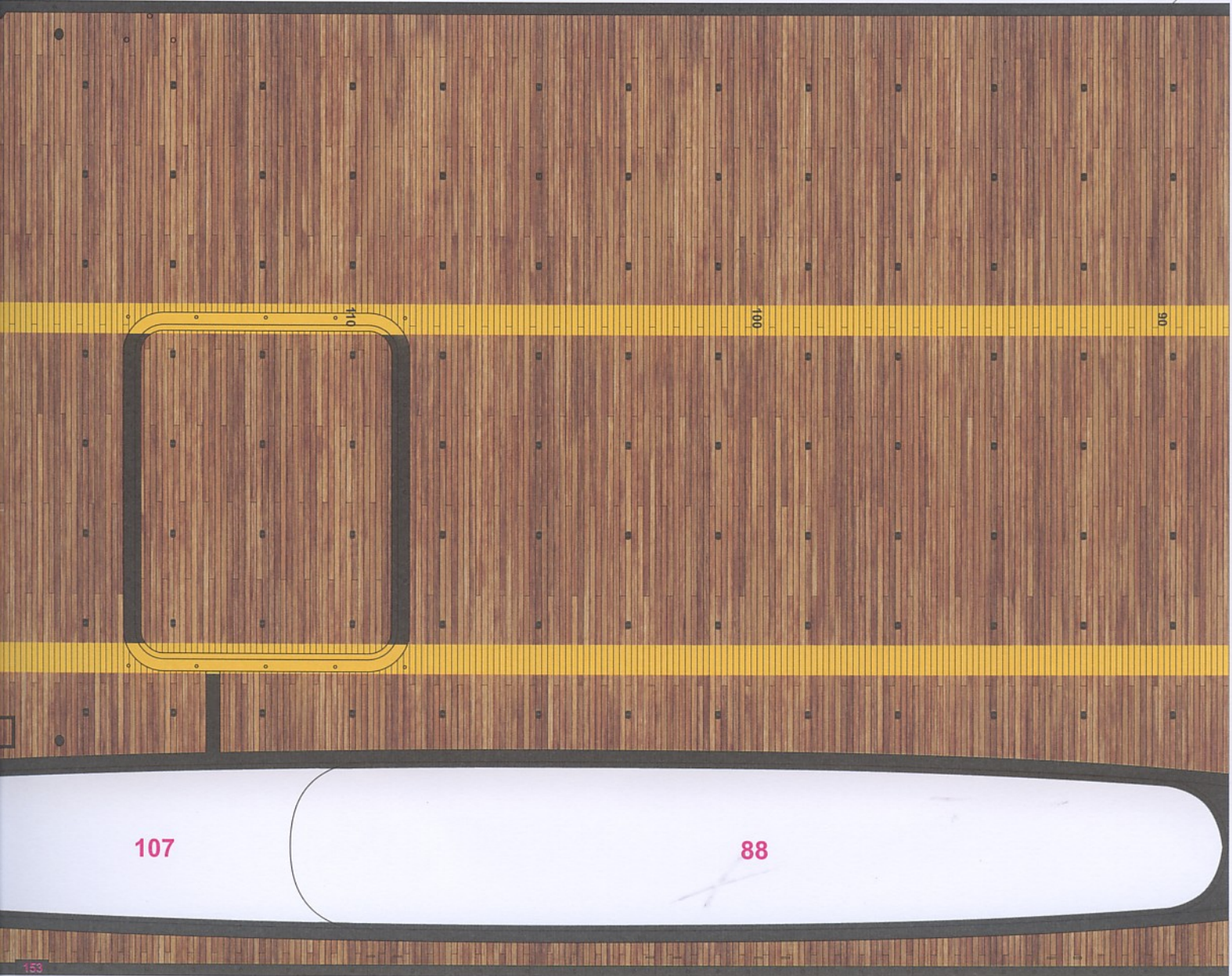

107

88

153

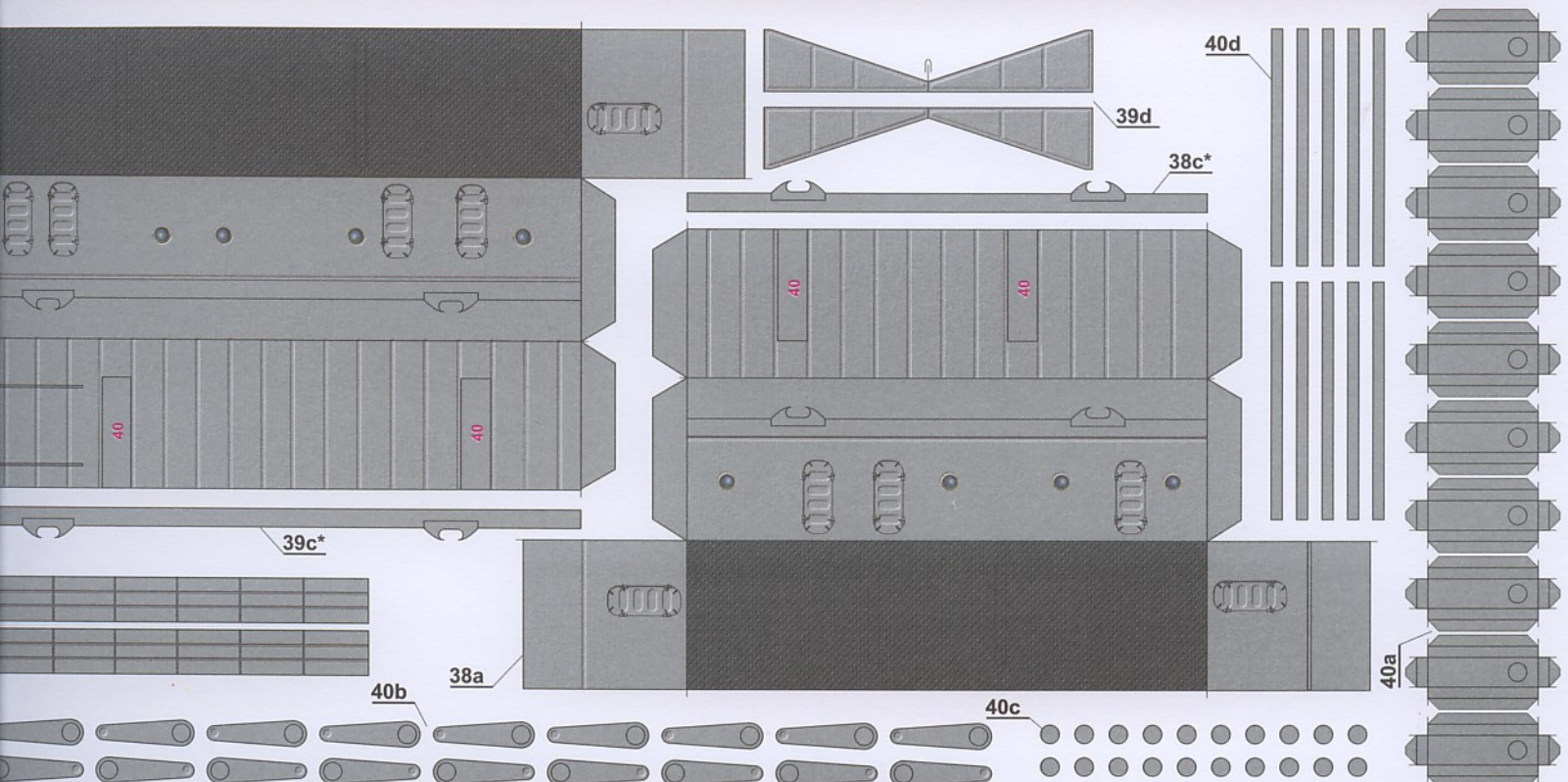

40d

39d

38c\*

40

40

39c\*

40b

38a

40c

40a

64a

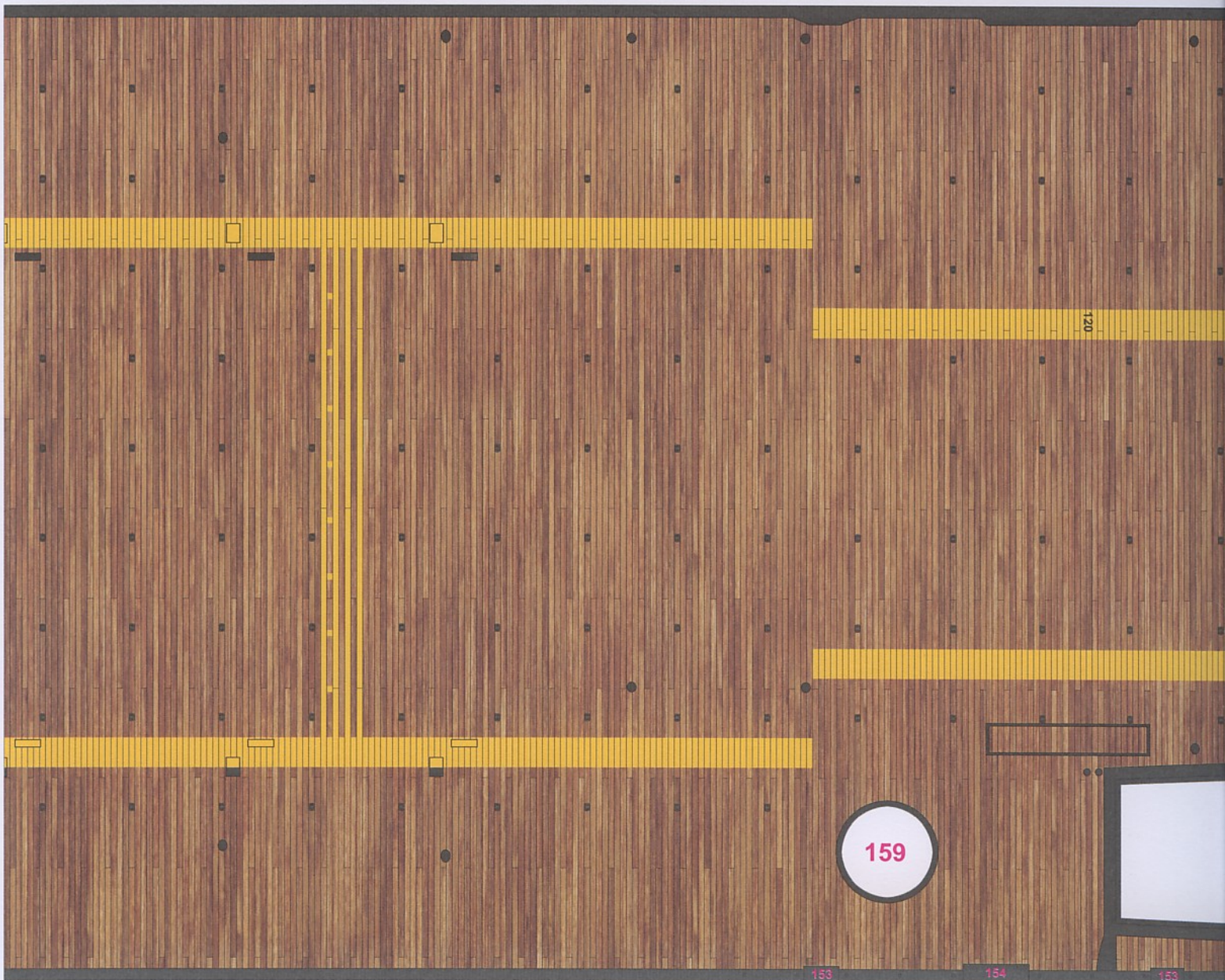

120

159

153

154

153

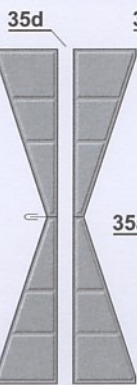

35c

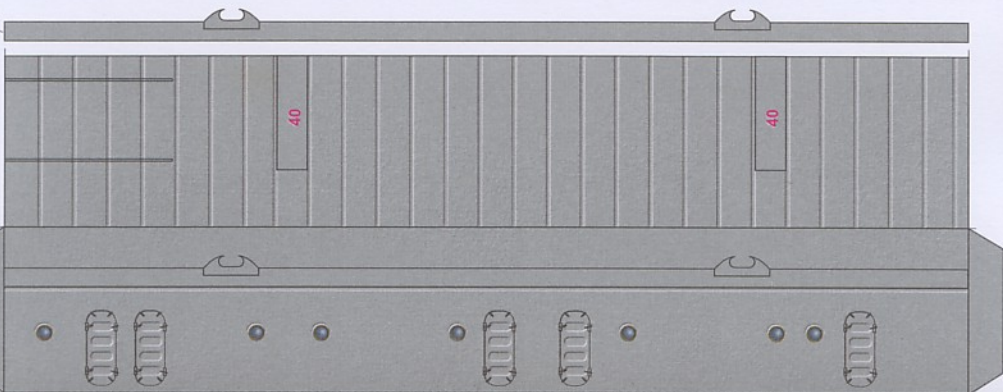

40

40

39a

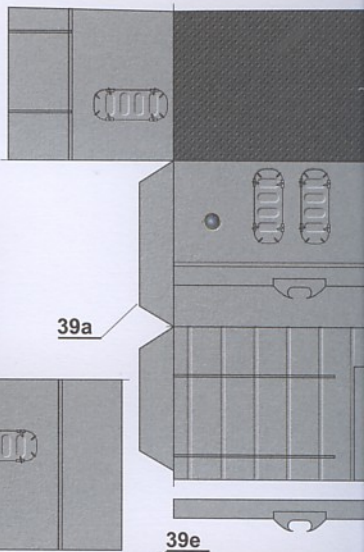

39e



35e



35f

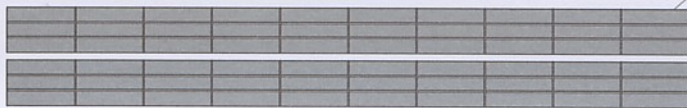

35b

36b

37b

38b

39b

39f





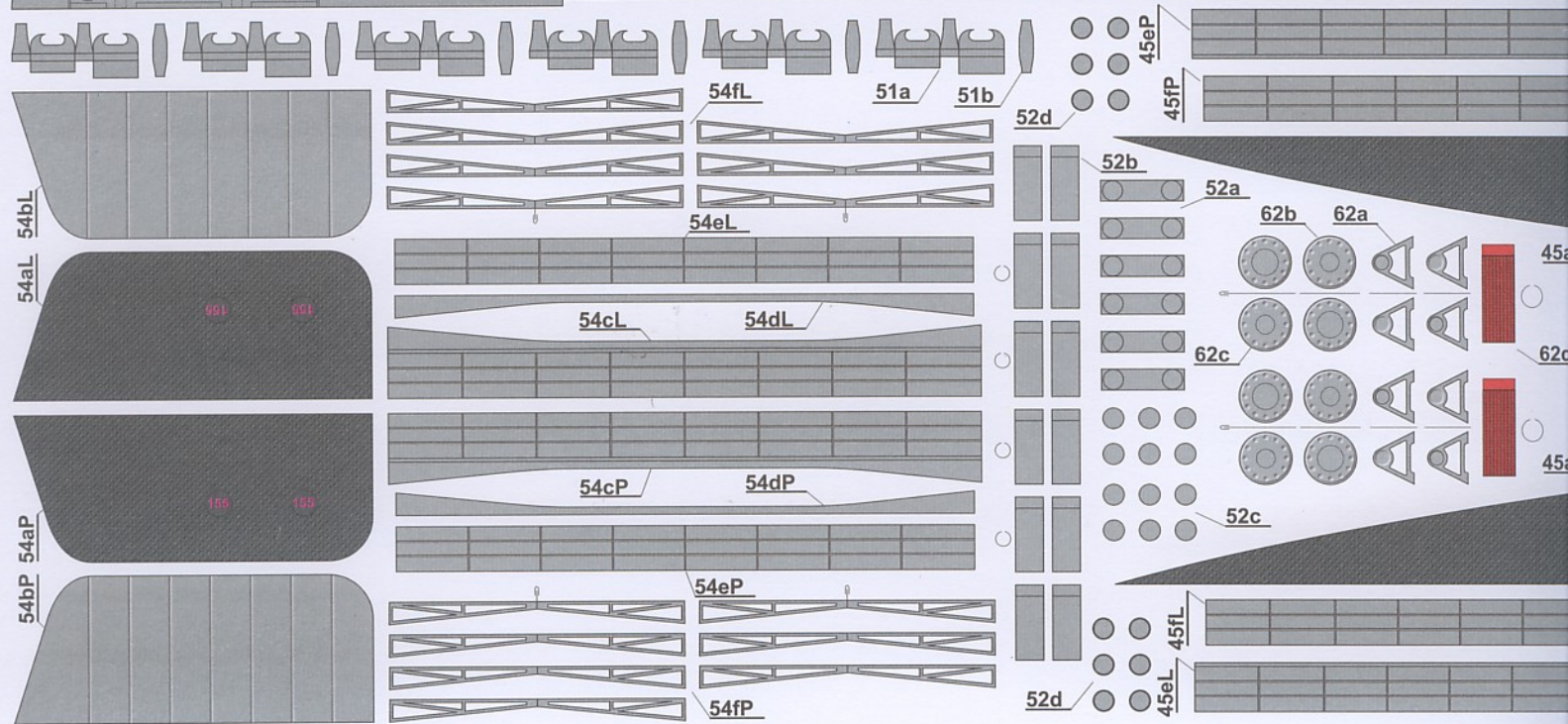
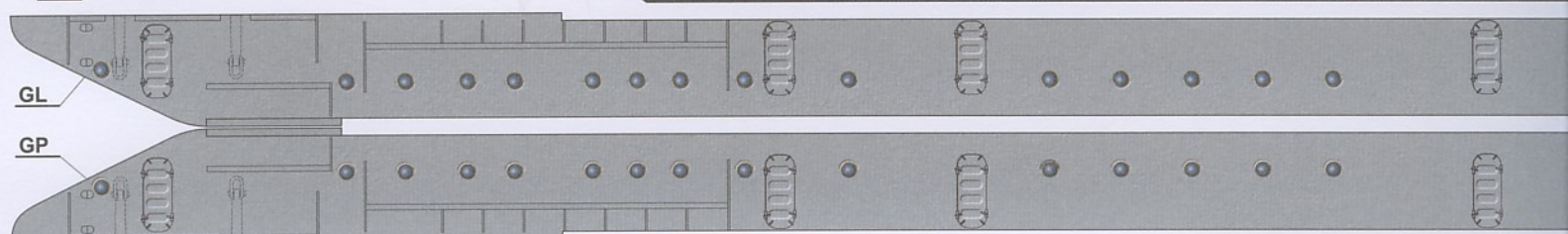
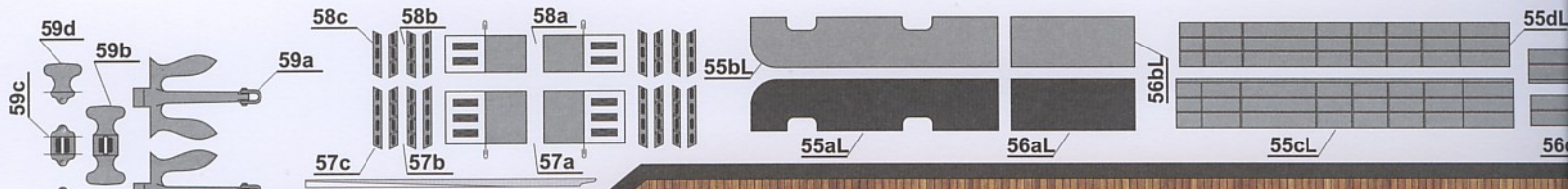

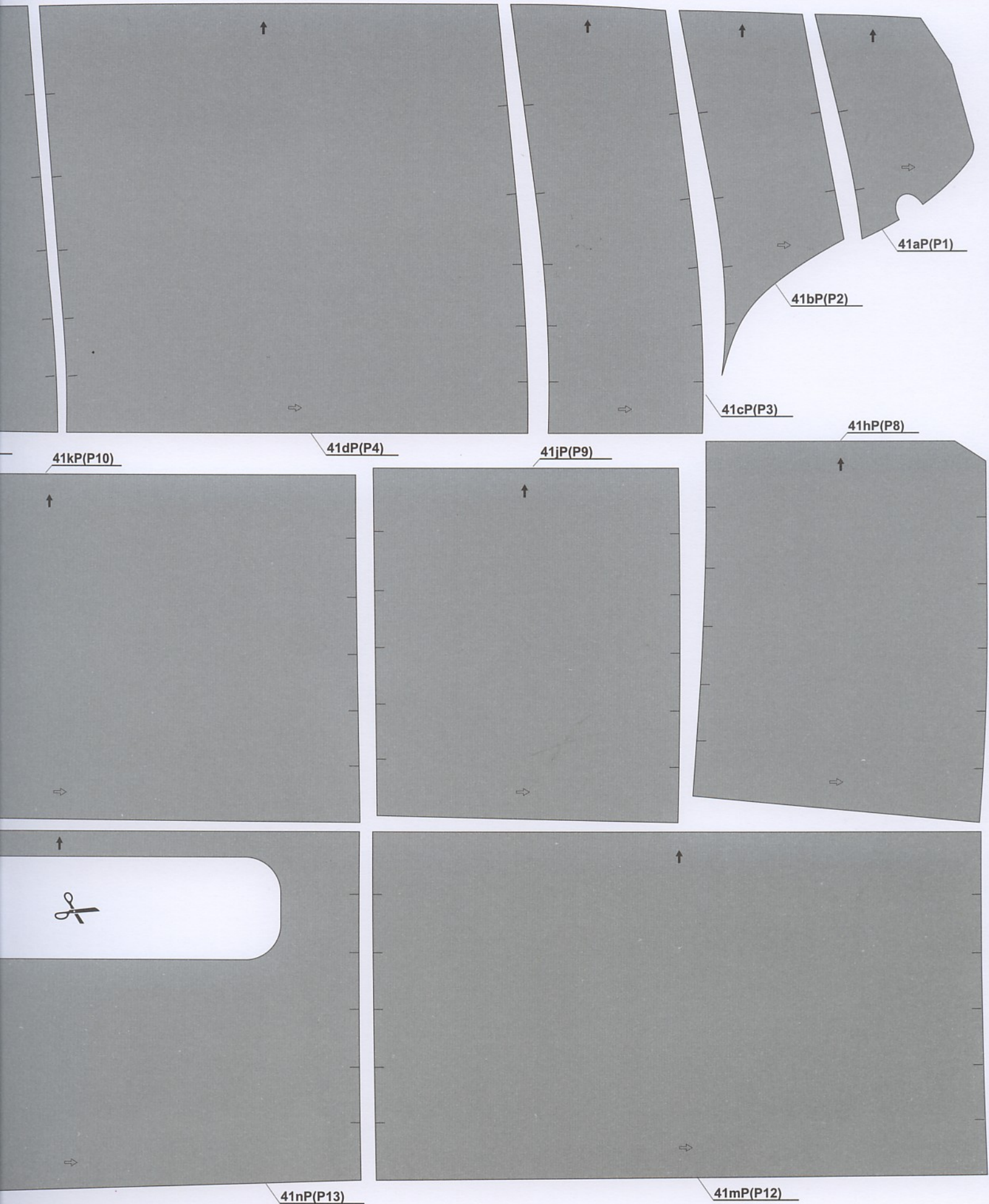

41kP(P10)

41dP(P4)

41jP(P9)

41hP(P8)

41cP(P3)

41bP(P2)

41aP(P1)

41nP(P13)

41mP(P12)

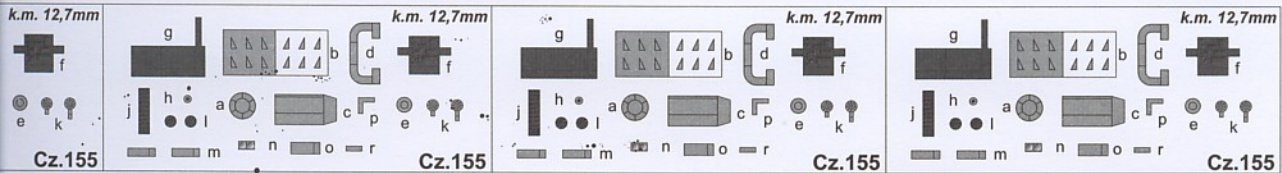

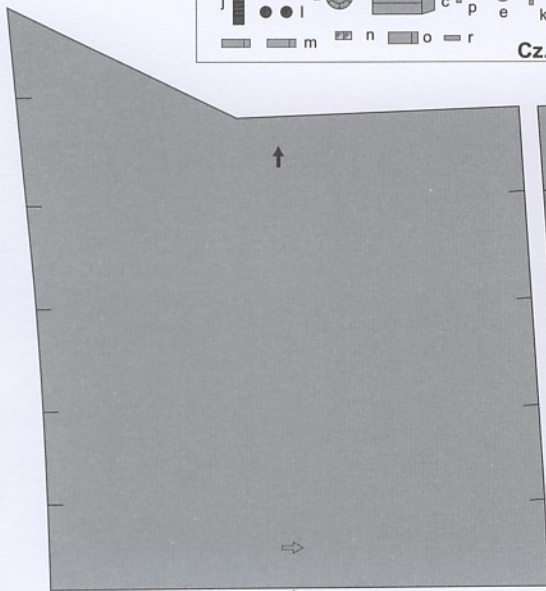
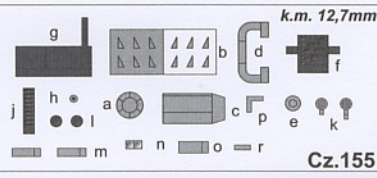
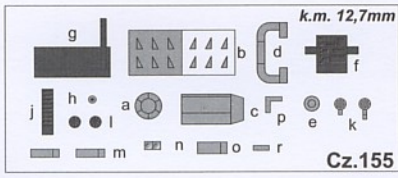

41gP(P7)

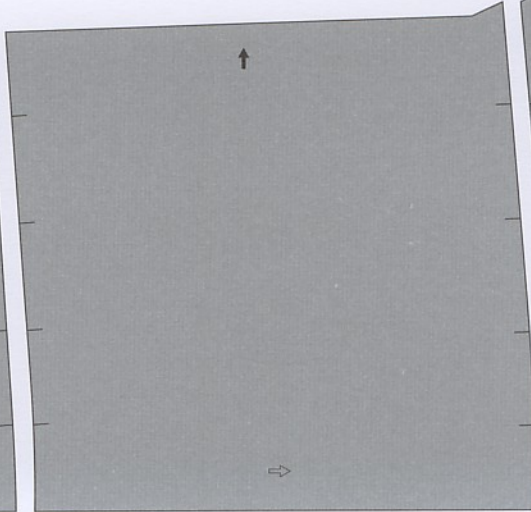

41fP(P6)

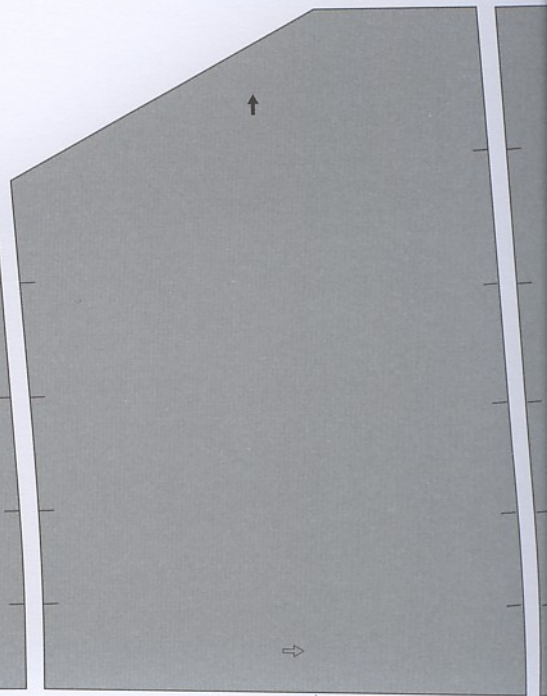

41eP(P5)

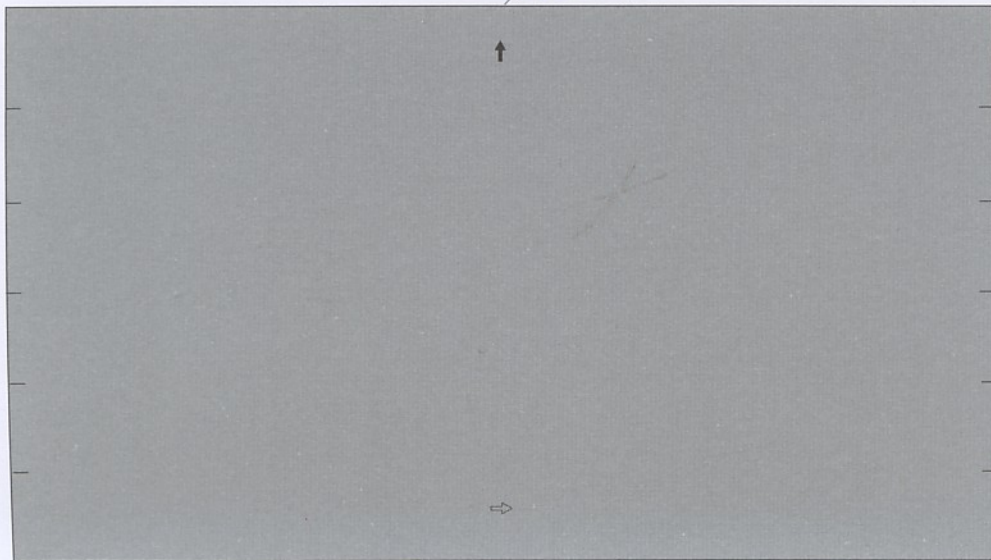

41IP(P11)

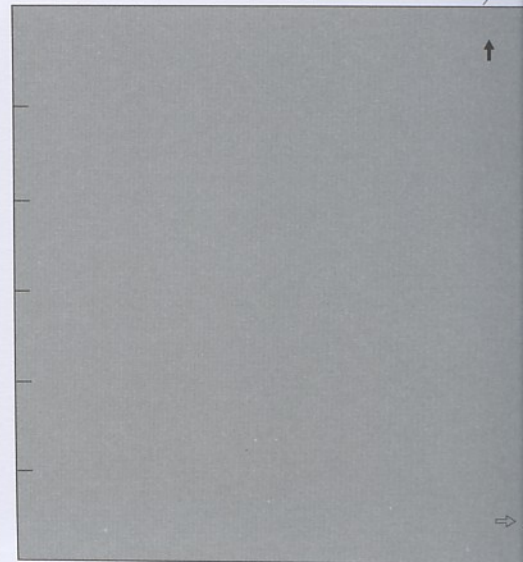

41IP(P11)

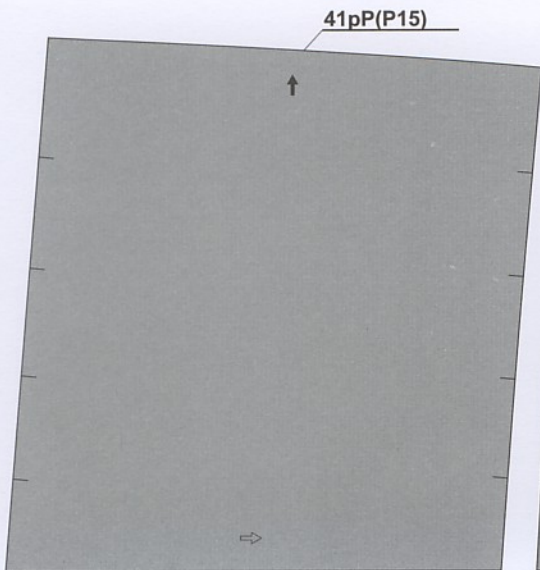

41pP(P15)

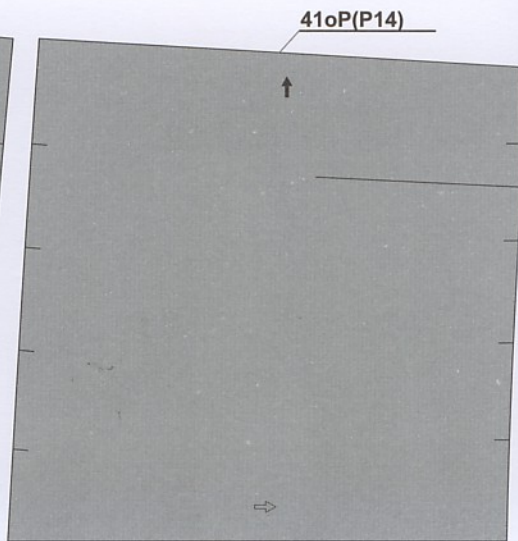

41oP(P14)

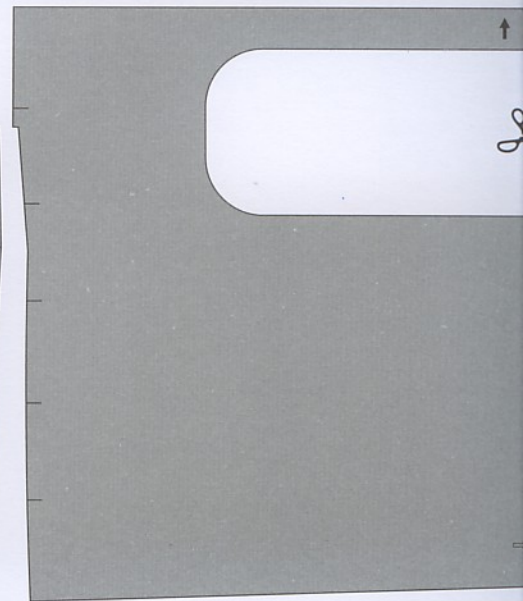

41oP(P14)

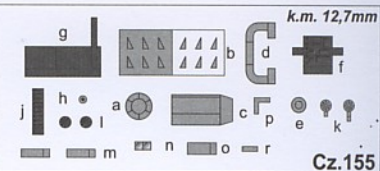
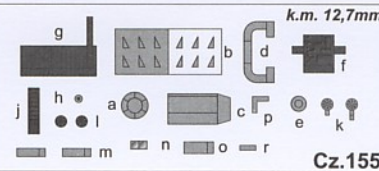
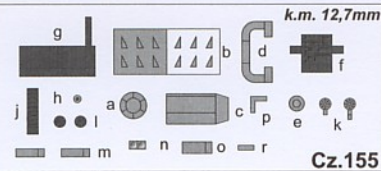
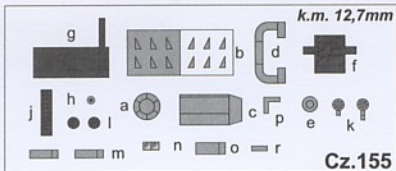

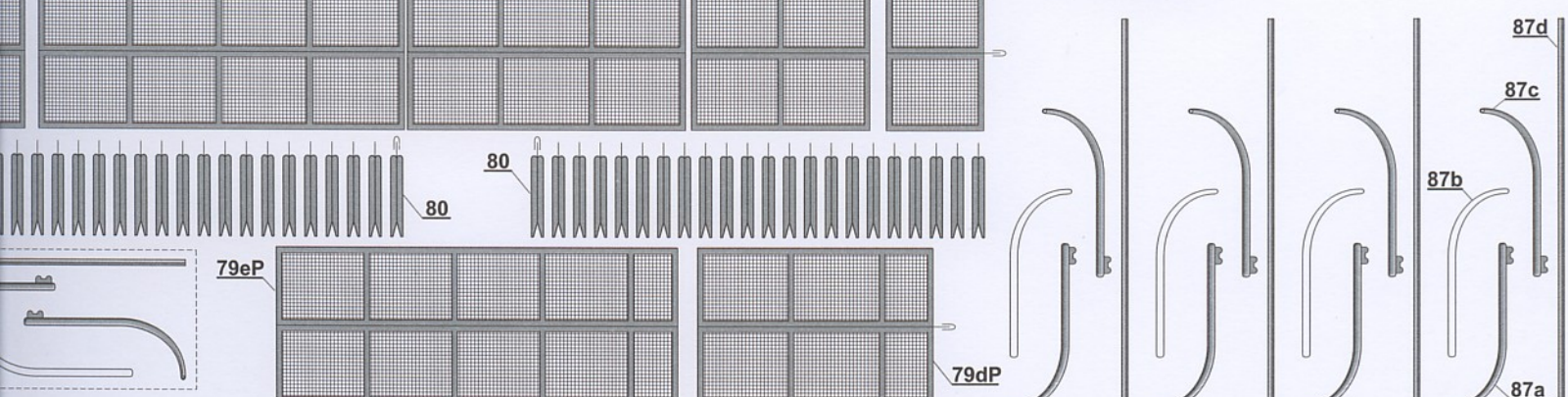
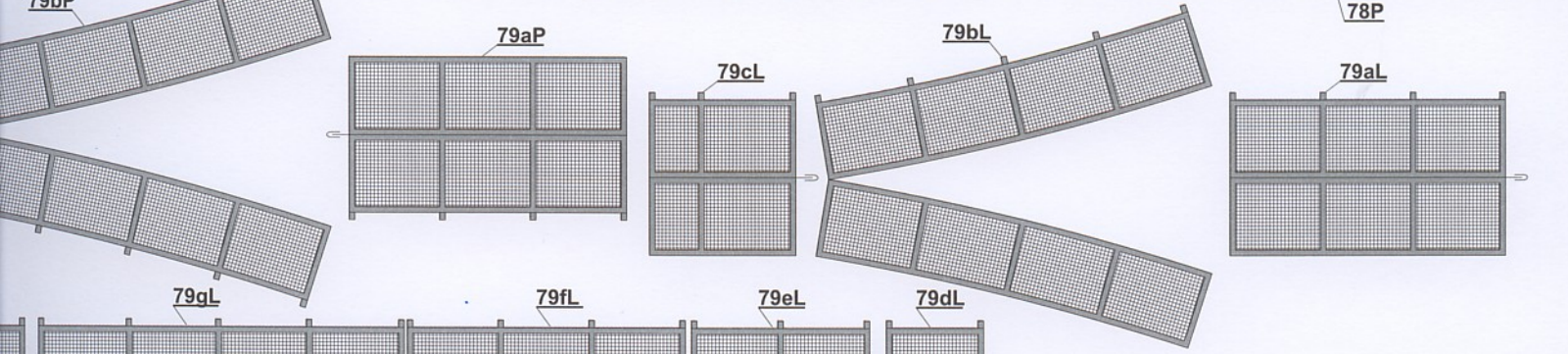
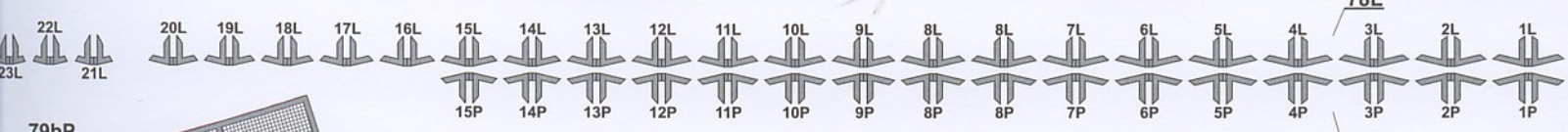
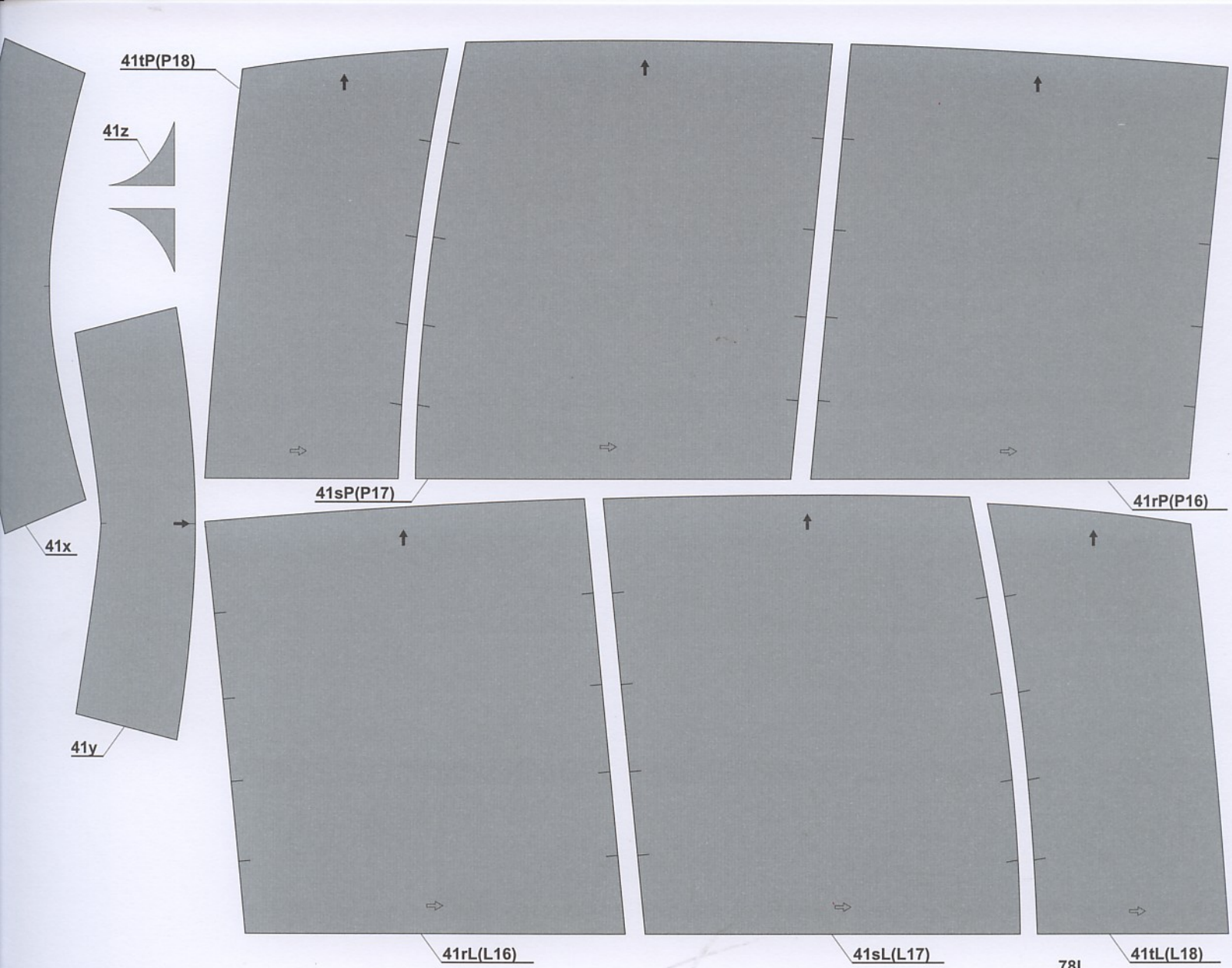

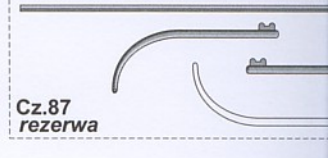
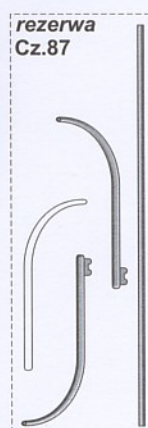
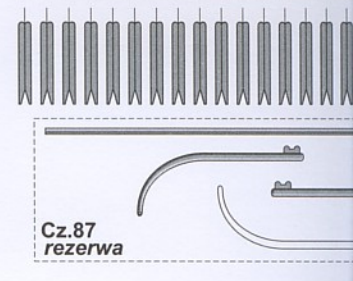
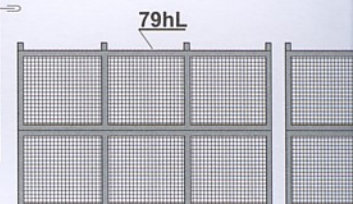
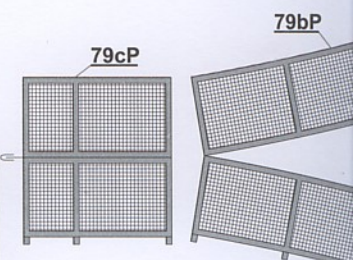
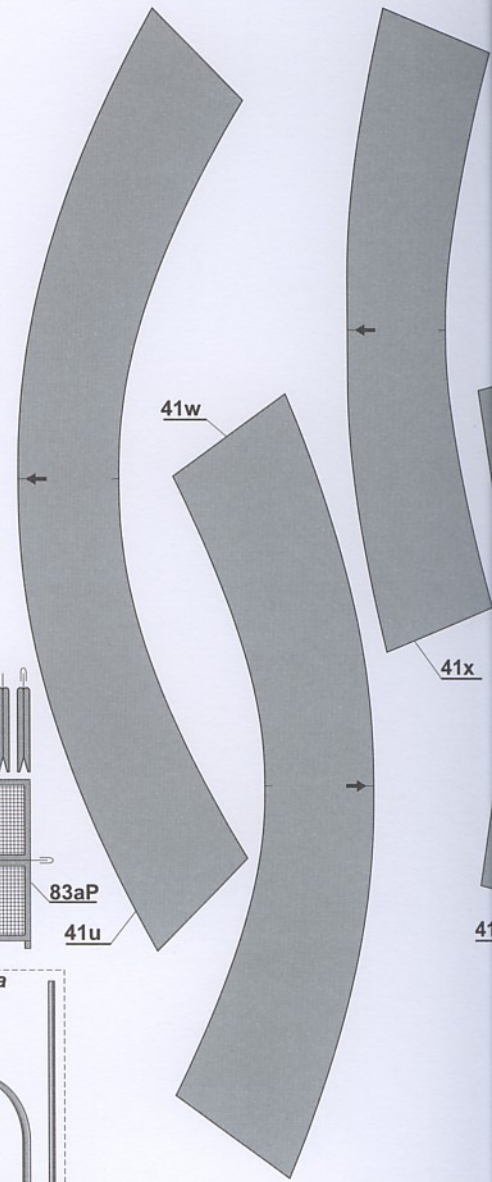
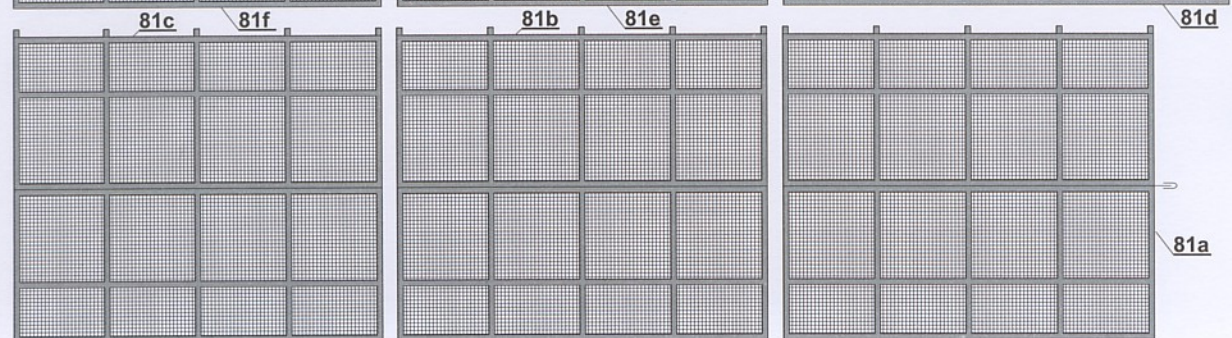
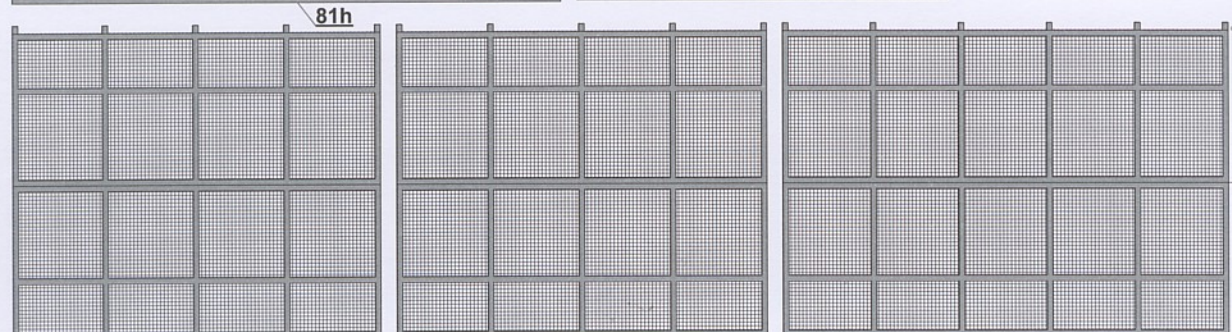
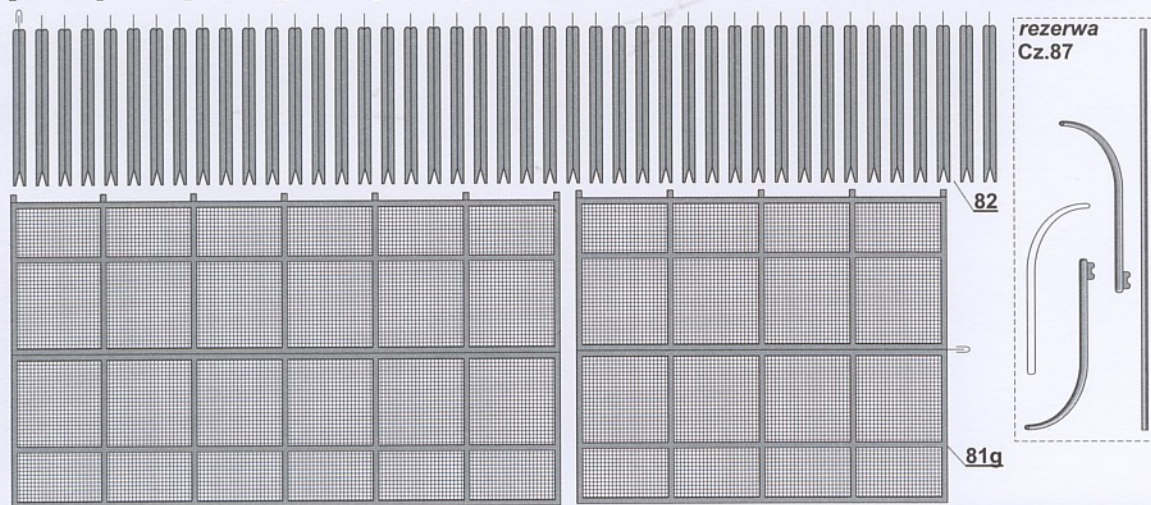
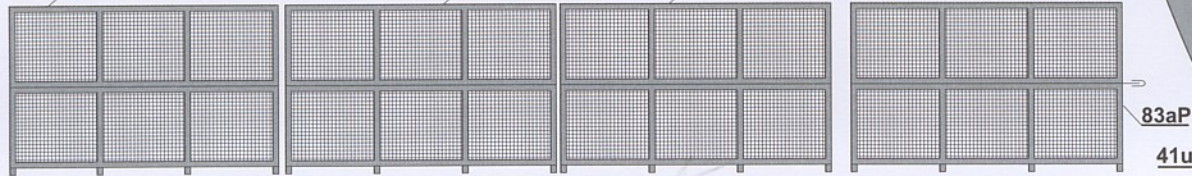
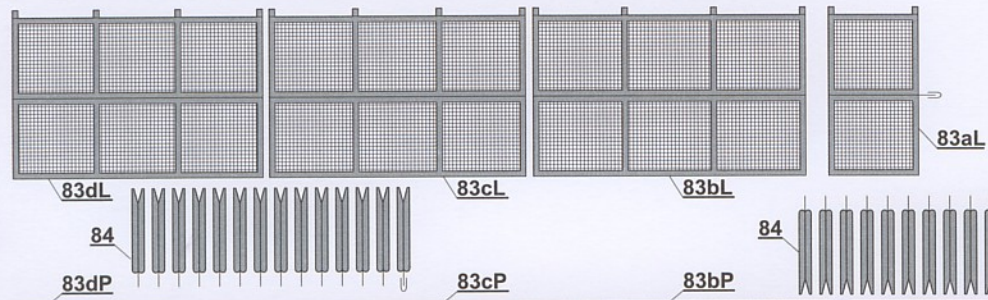
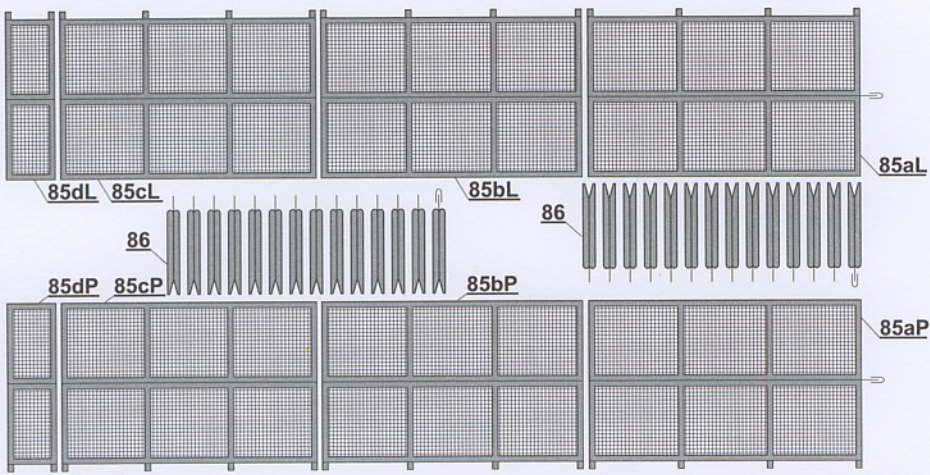

Cz.87 rezerwa



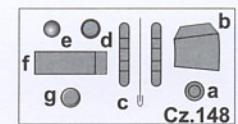
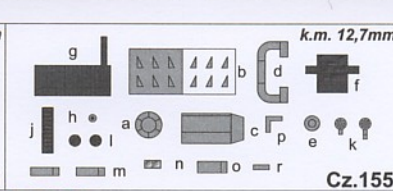
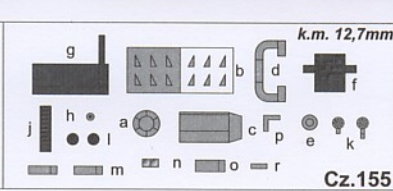
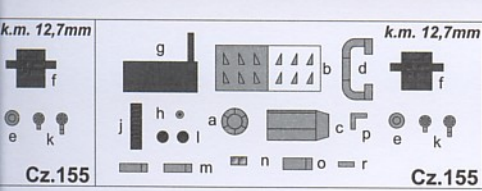
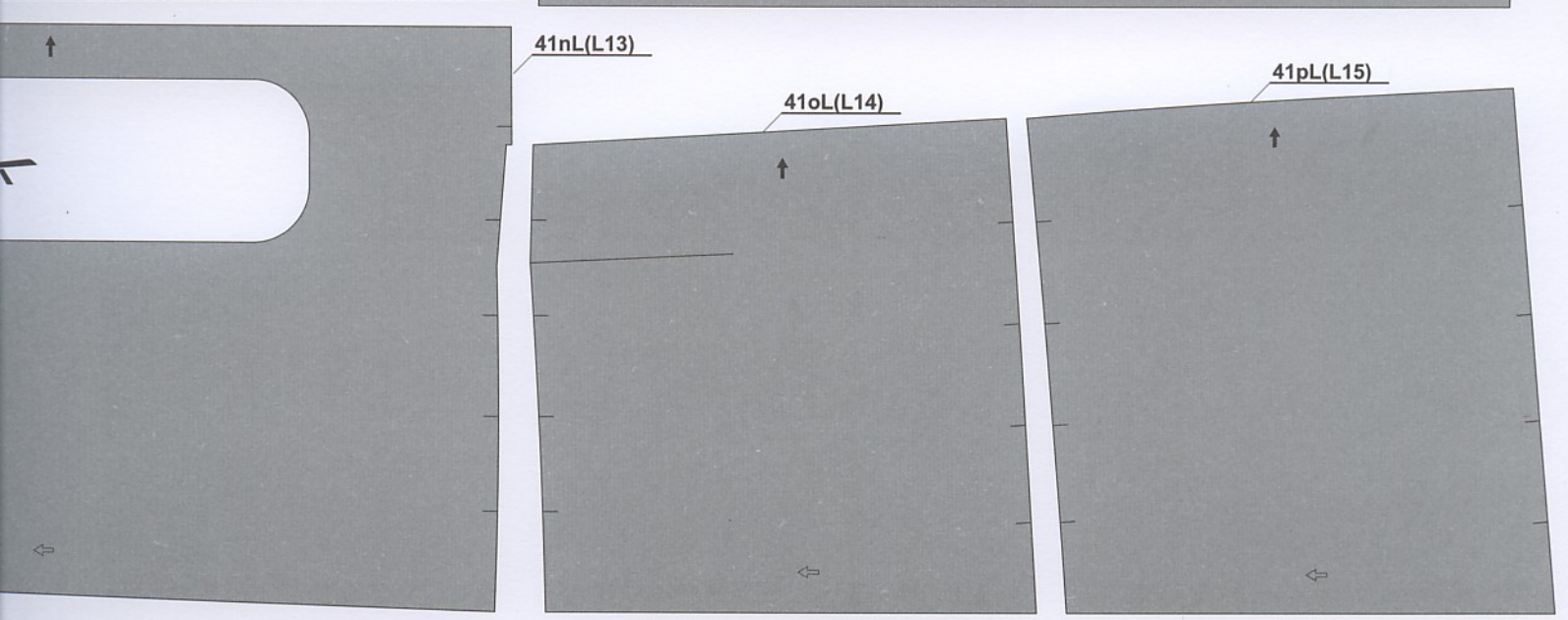
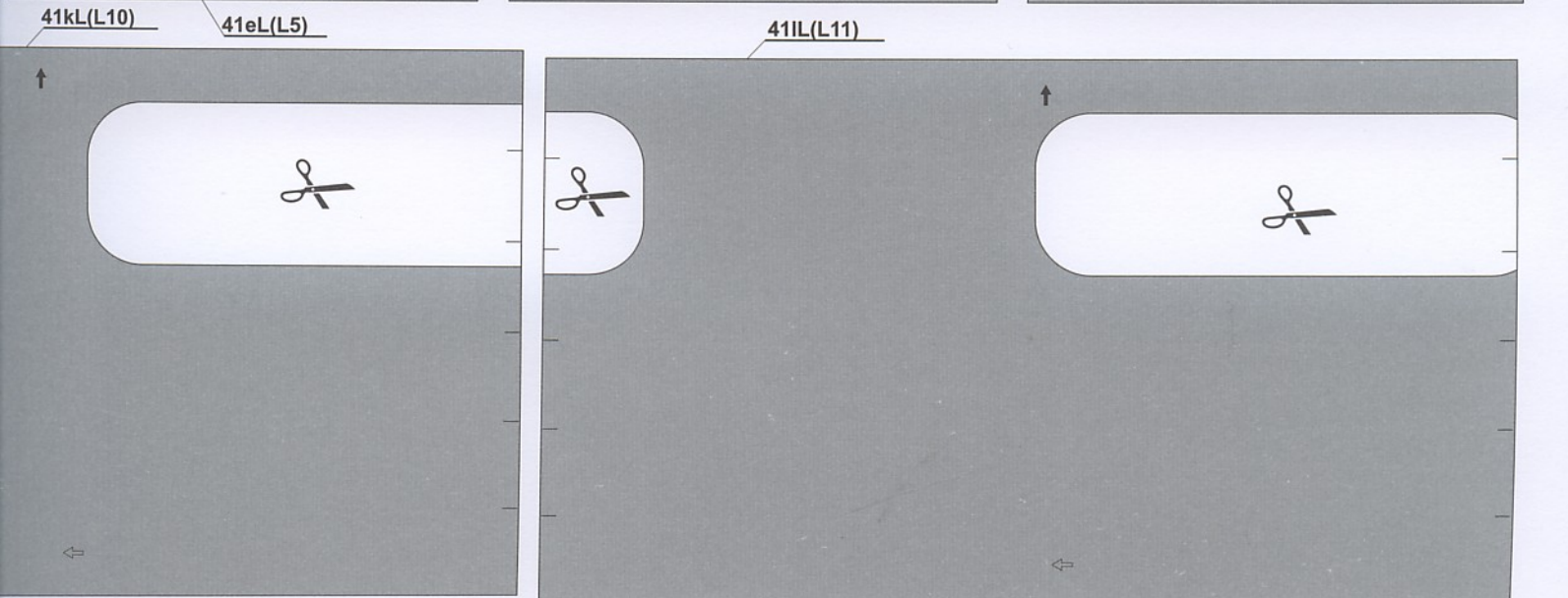
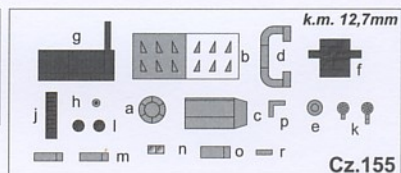
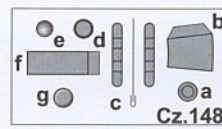
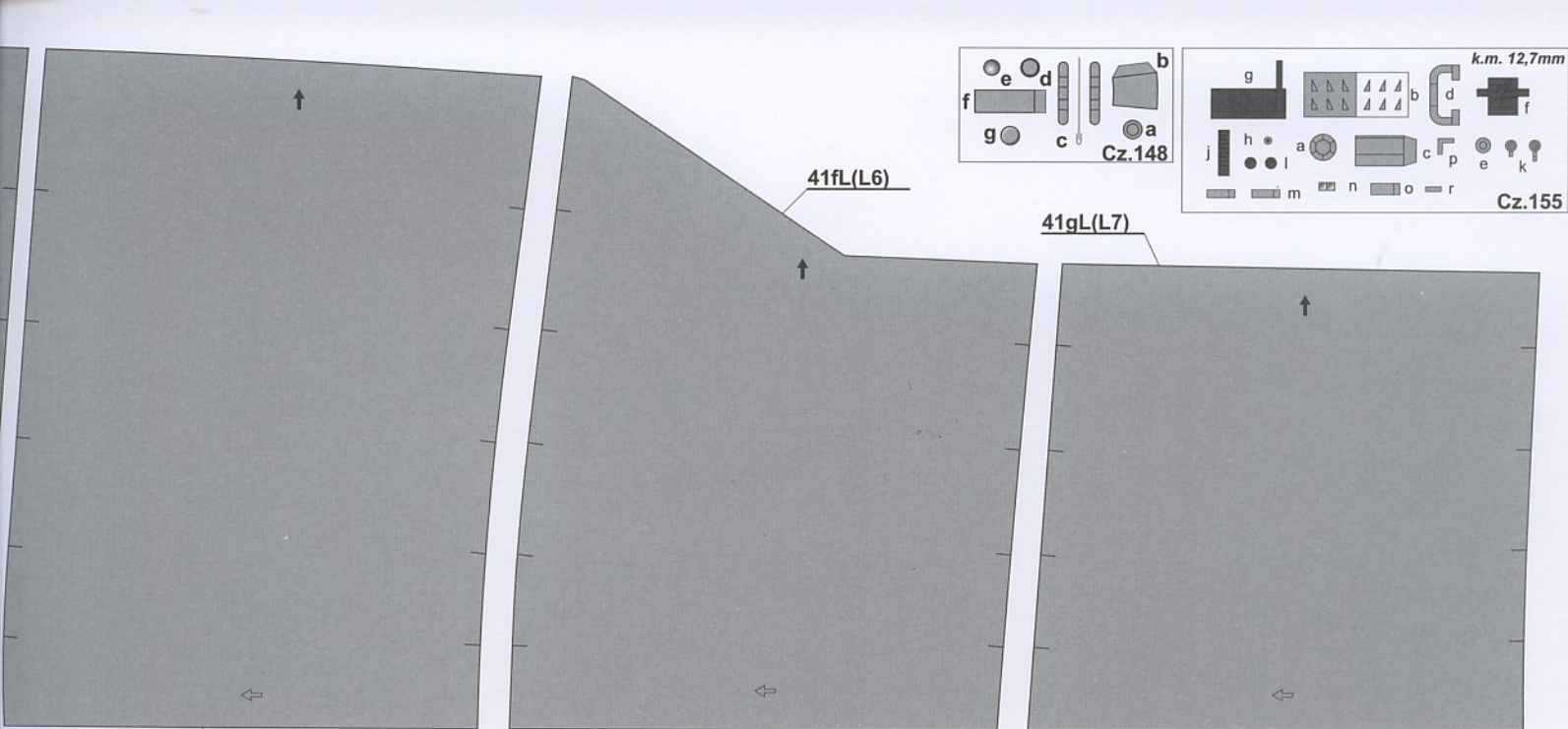

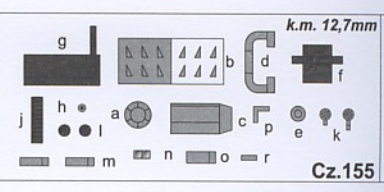
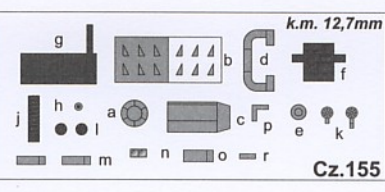
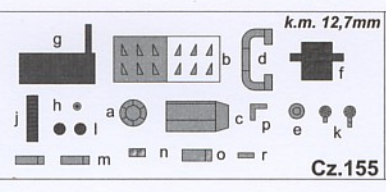
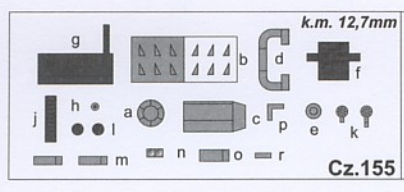
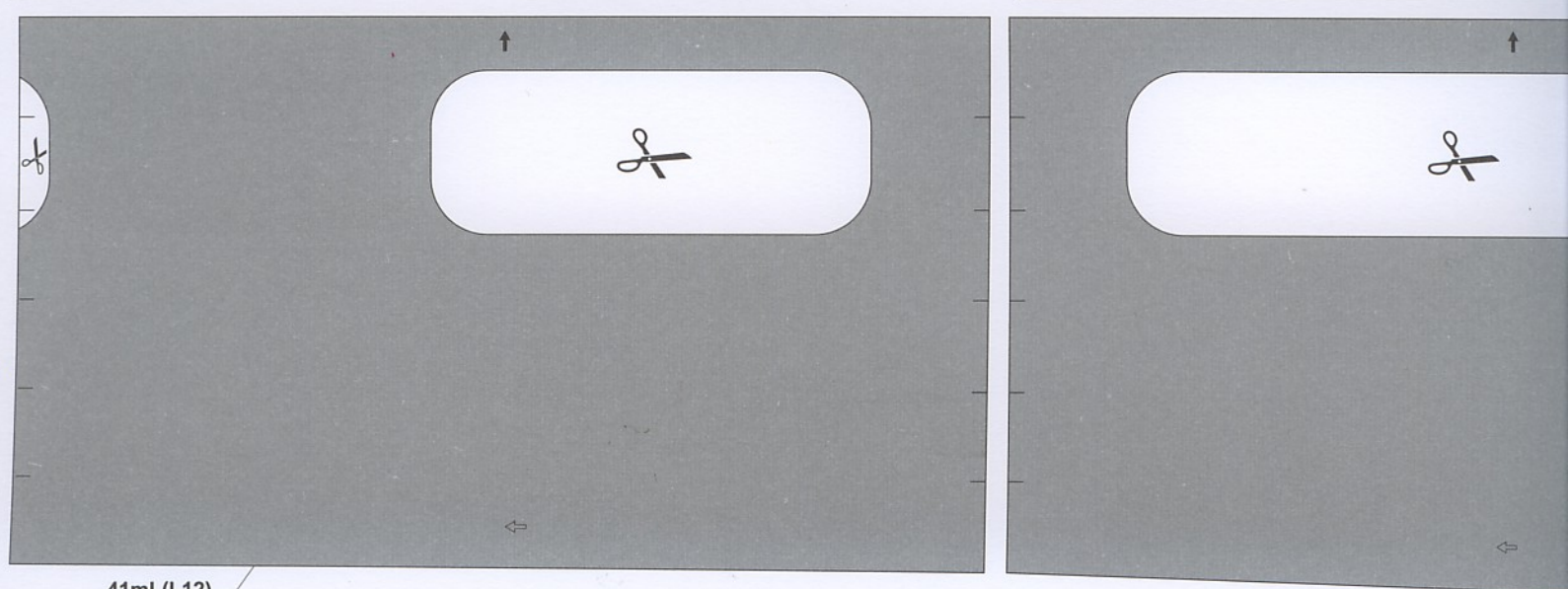
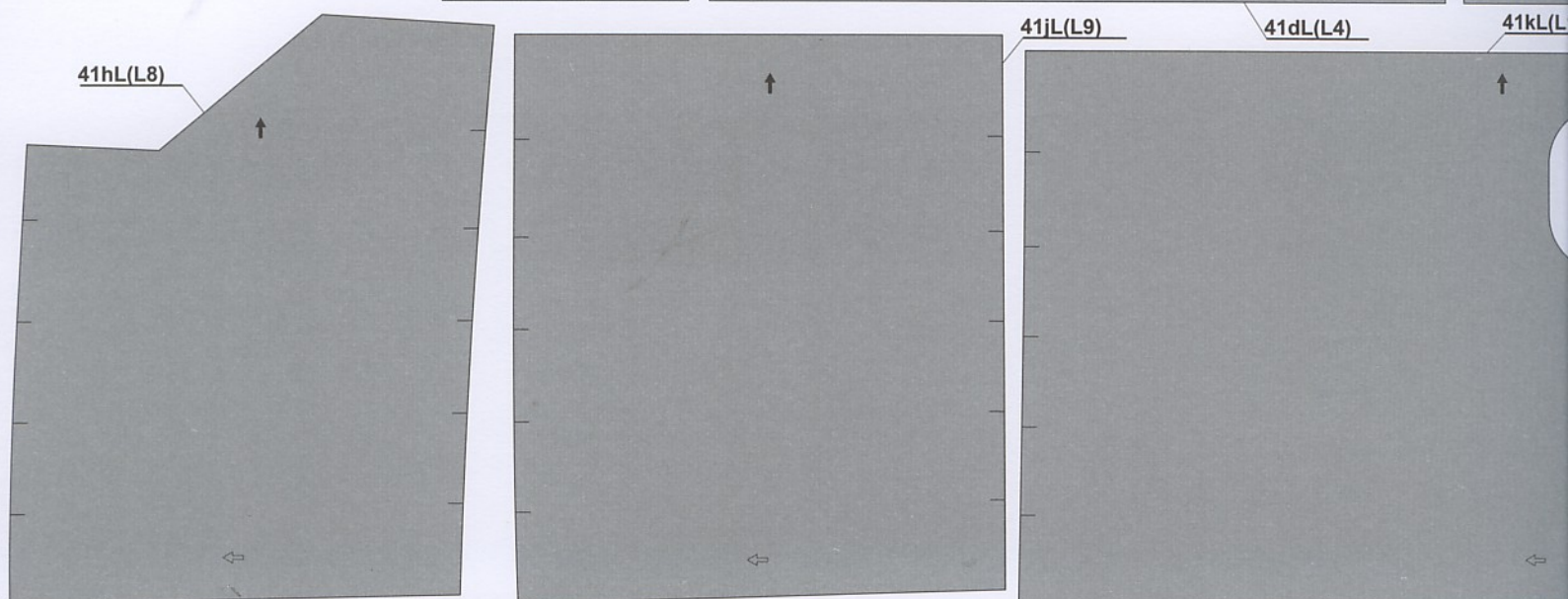
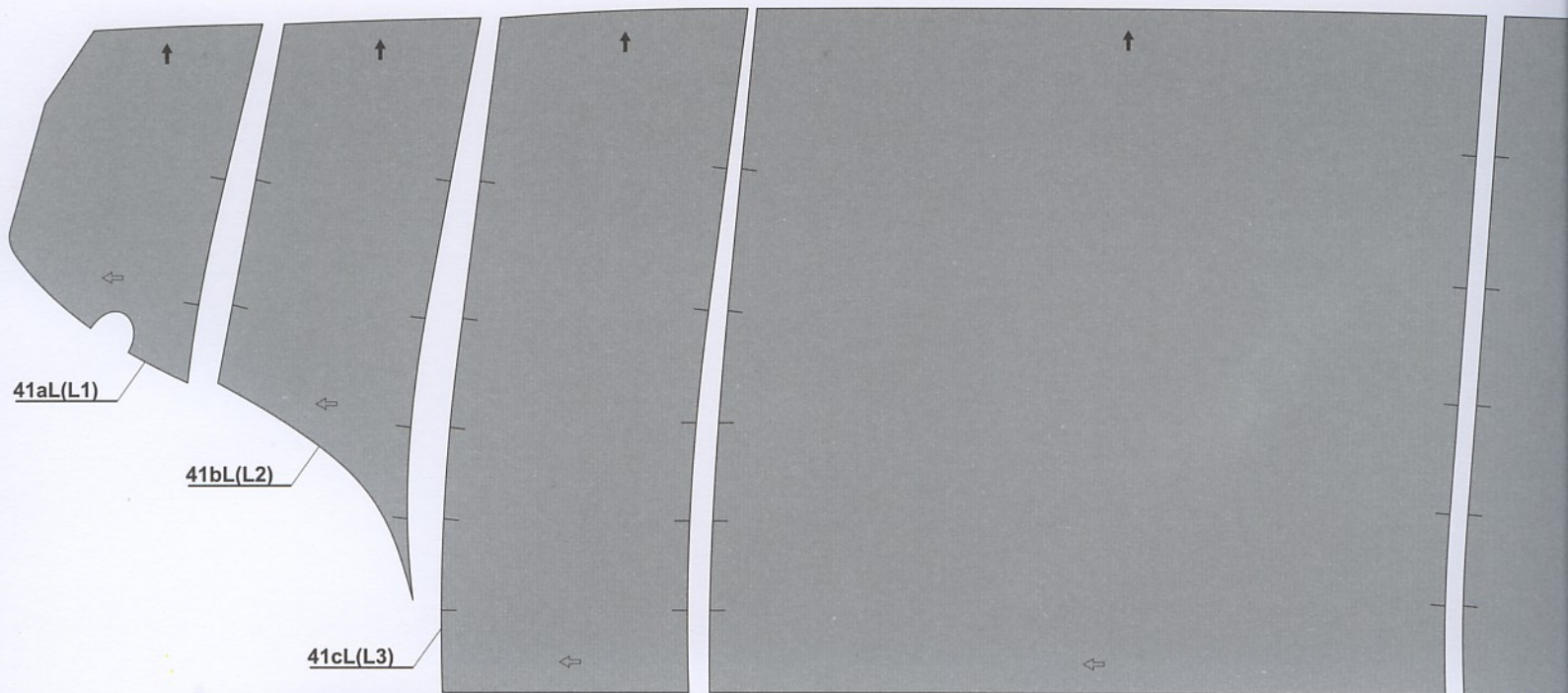

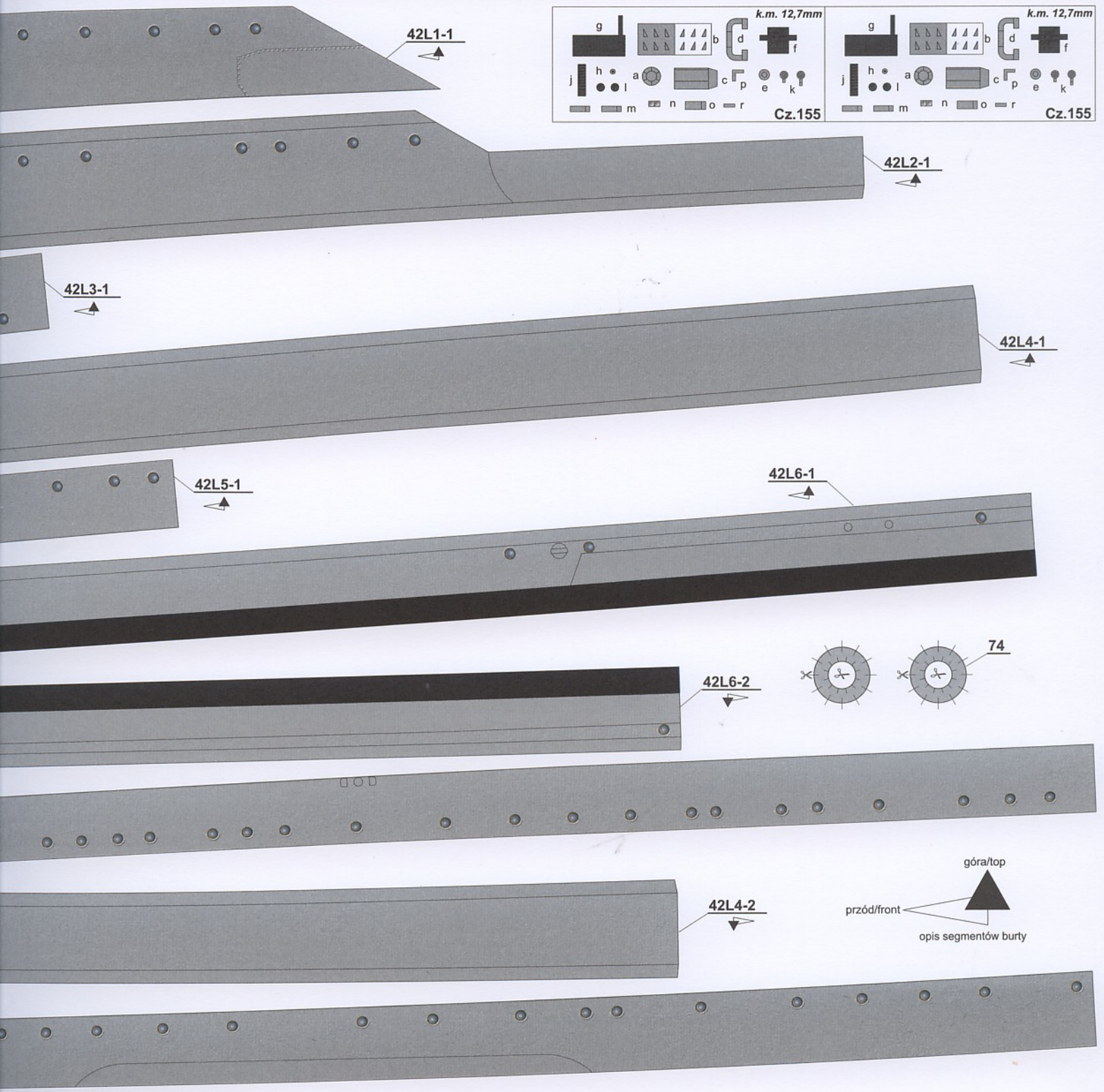

<p>76b</p> <p>rezerva Cz.148</p> <p>rezerva Cz.148</p> <p>rezerva Cz.148</p>	<p>rezerva Cz.155</p> <p>Cz.155</p>	<p>rezerva Cz.155</p> <p>Cz.155</p>	<p>rezerva Cz.155</p> <p>Cz.155</p>	
	<p>rezerva Cz.155</p> <p>Cz.155</p>	<p>rezerva Cz.155</p> <p>Cz.155</p>	<p>rezerva Cz.155</p> <p>Cz.155</p>	<p>rezerva Cz.155</p> <p>Cz.155</p>
	<p>rezerva Cz.155</p> <p>Cz.155</p>	<p>rezerva Cz.155</p> <p>Cz.155</p>	<p>rezerva Cz.155</p> <p>Cz.155</p>	<p>rezerva Cz.155</p> <p>Cz.155</p>

F5

72

73

rezerwa Cz.59

75

42L5-2

42L3-2

42L2-2

42L1-2

szablon x26  
lub cz.77c

77a 77b

77c

76c

76a

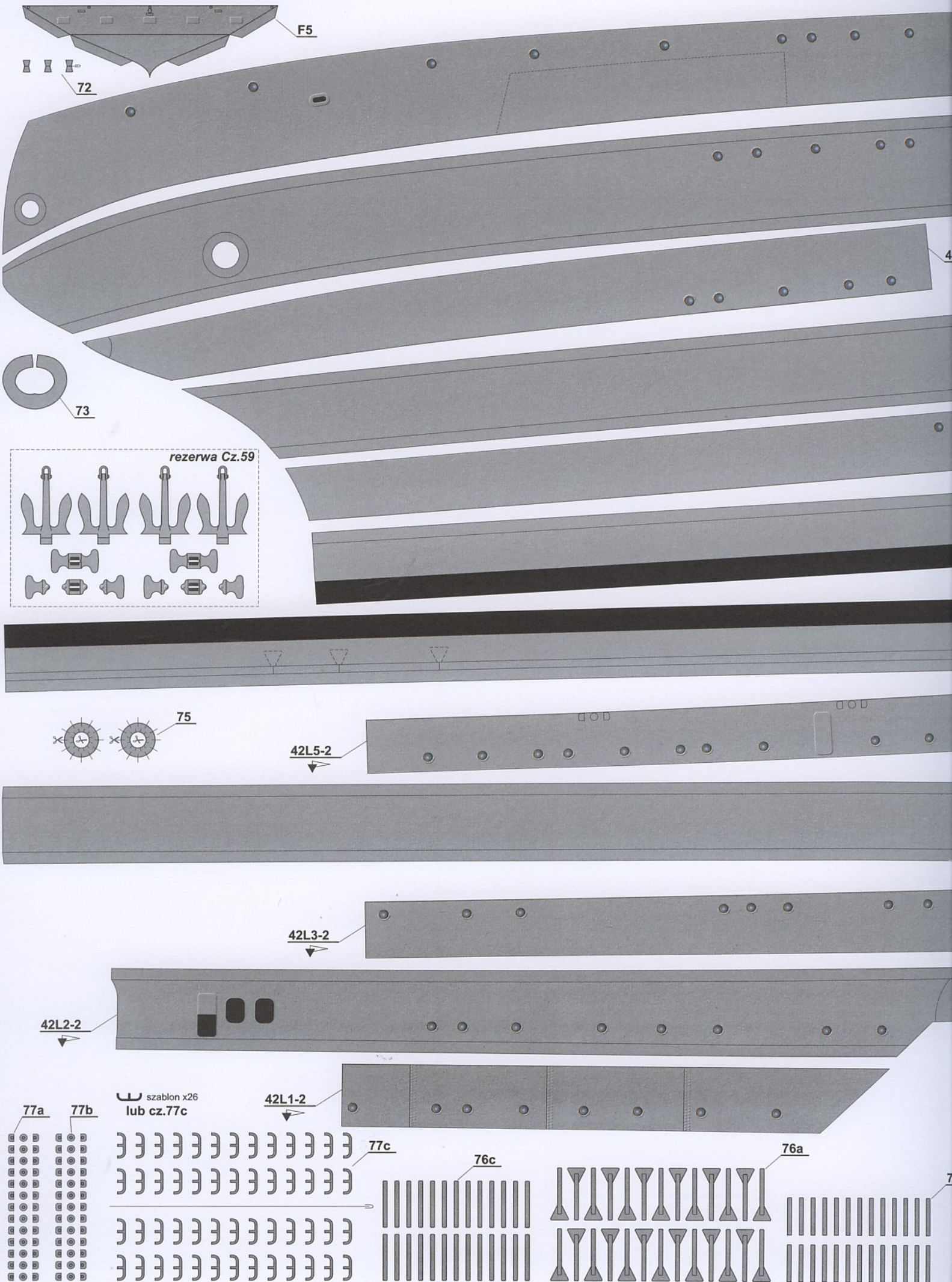

42L2-4

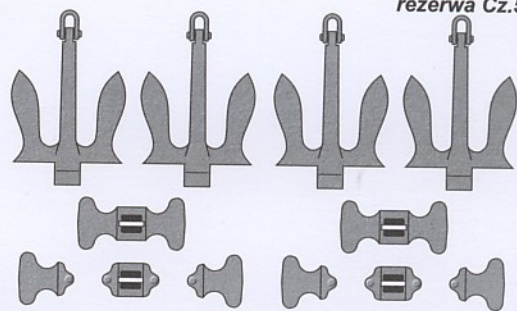

42L6-4

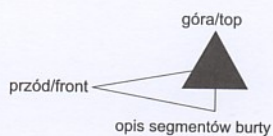

42L4-4

42L2-6

42L2-5

42L1-4

42L3-5

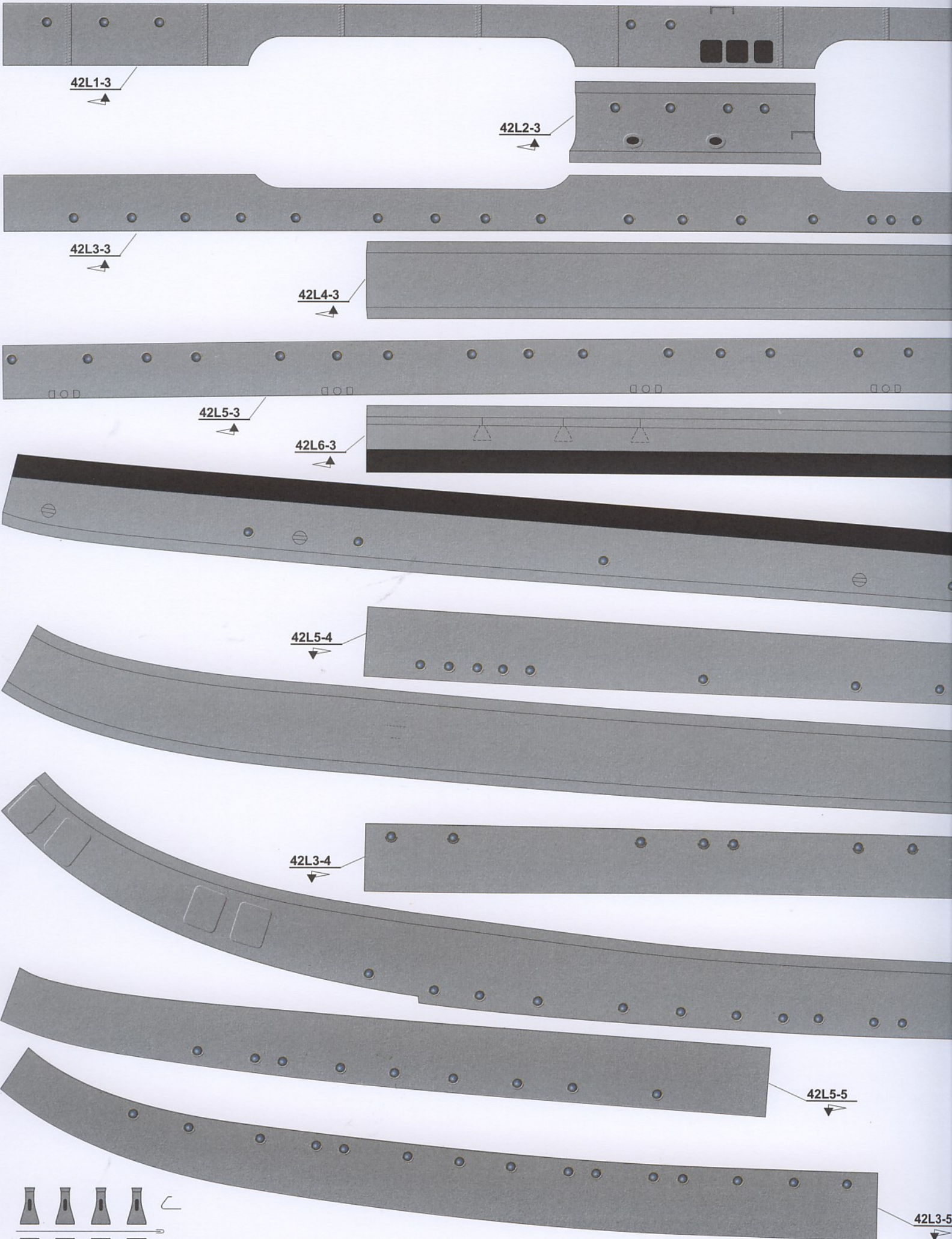

42L1-3

42L2-3

42L3-3

42L4-3

42L5-3

42L6-3

42L5-4

42L3-4

42L5-5

42L3-5

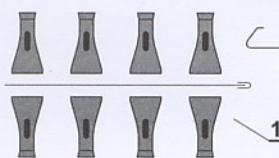

156

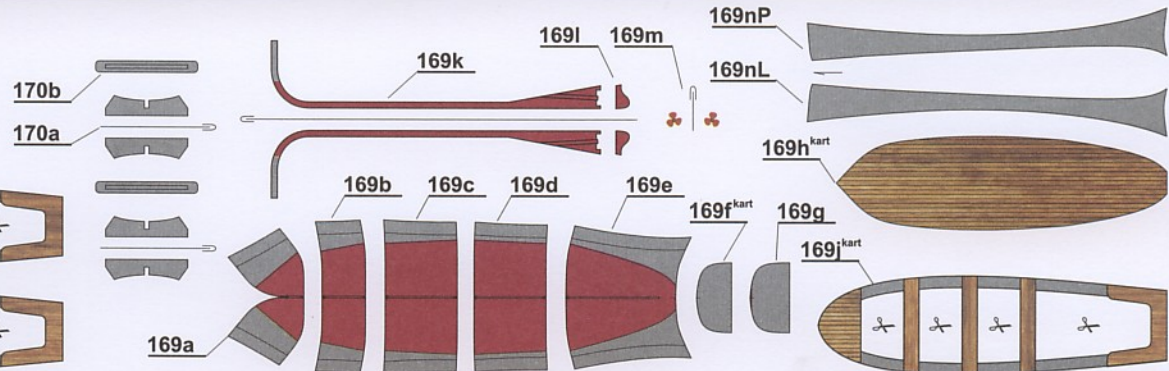
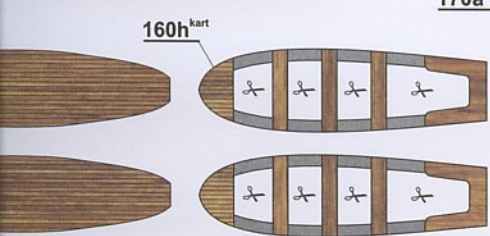
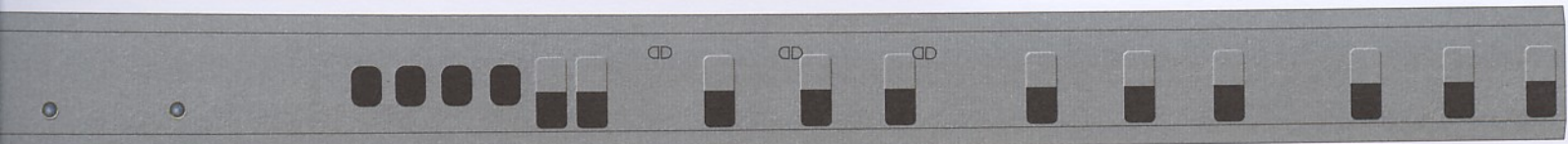
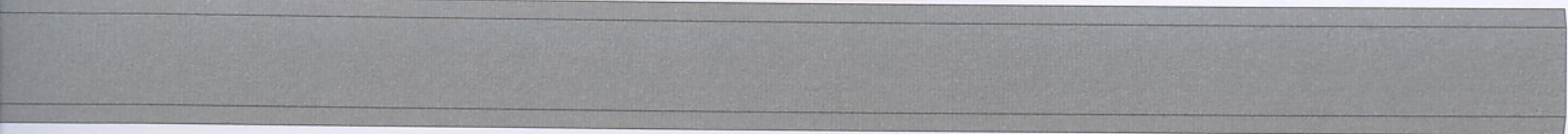
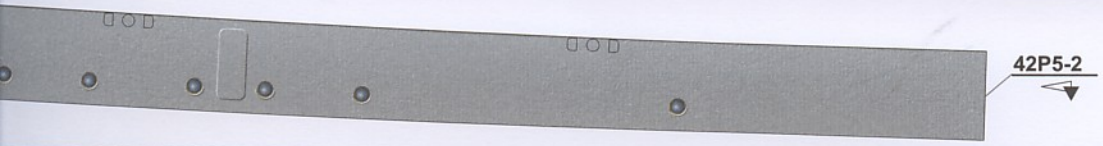
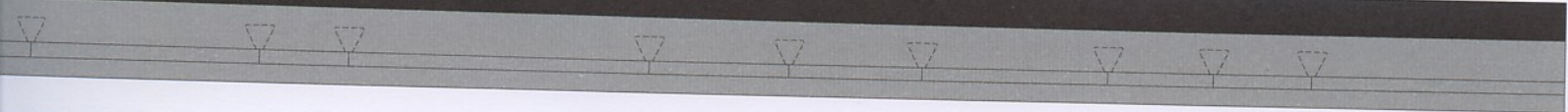
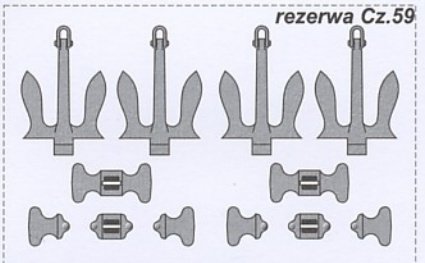

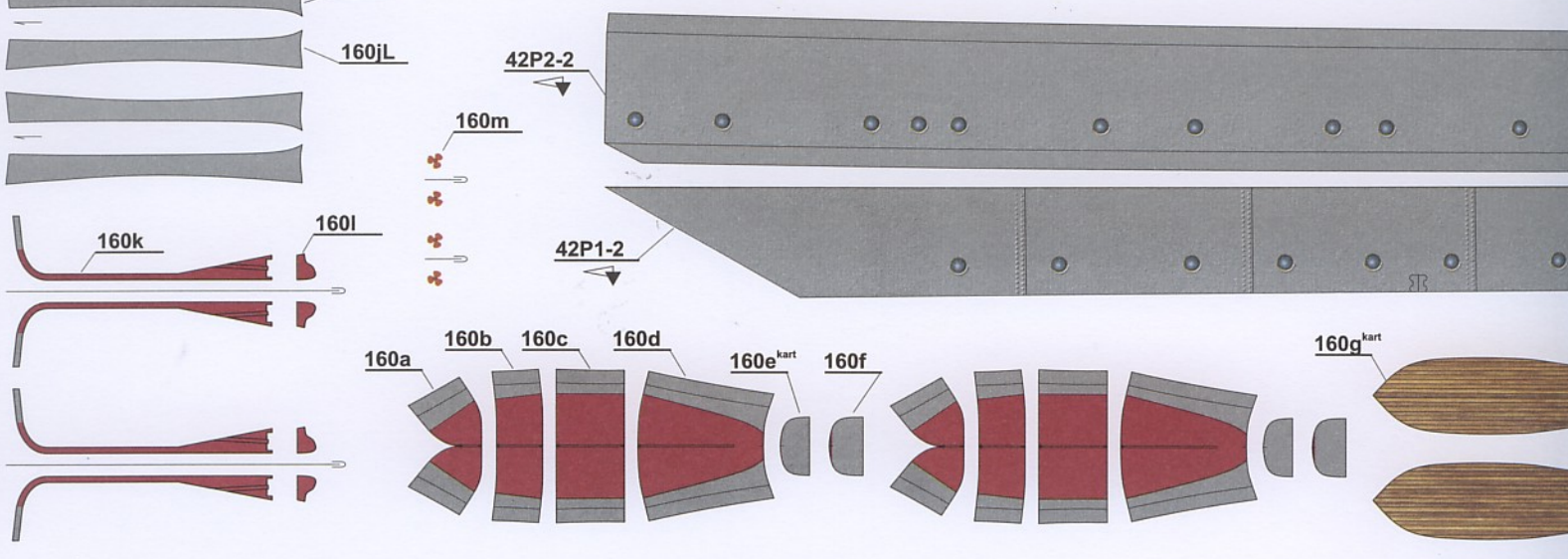
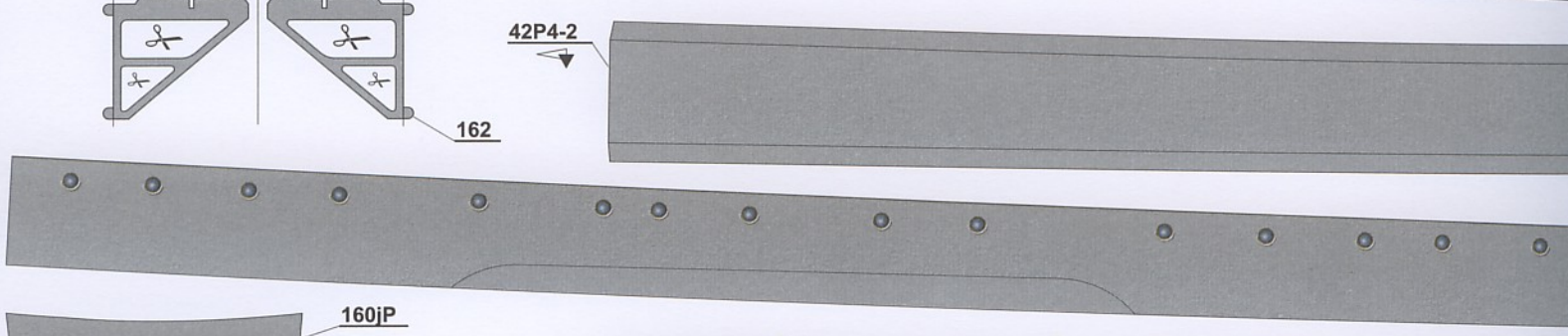
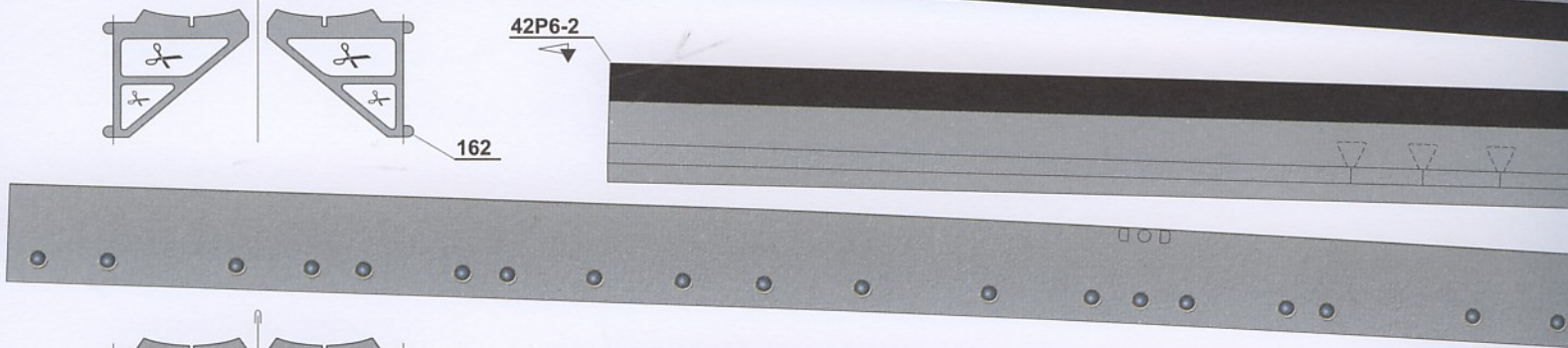
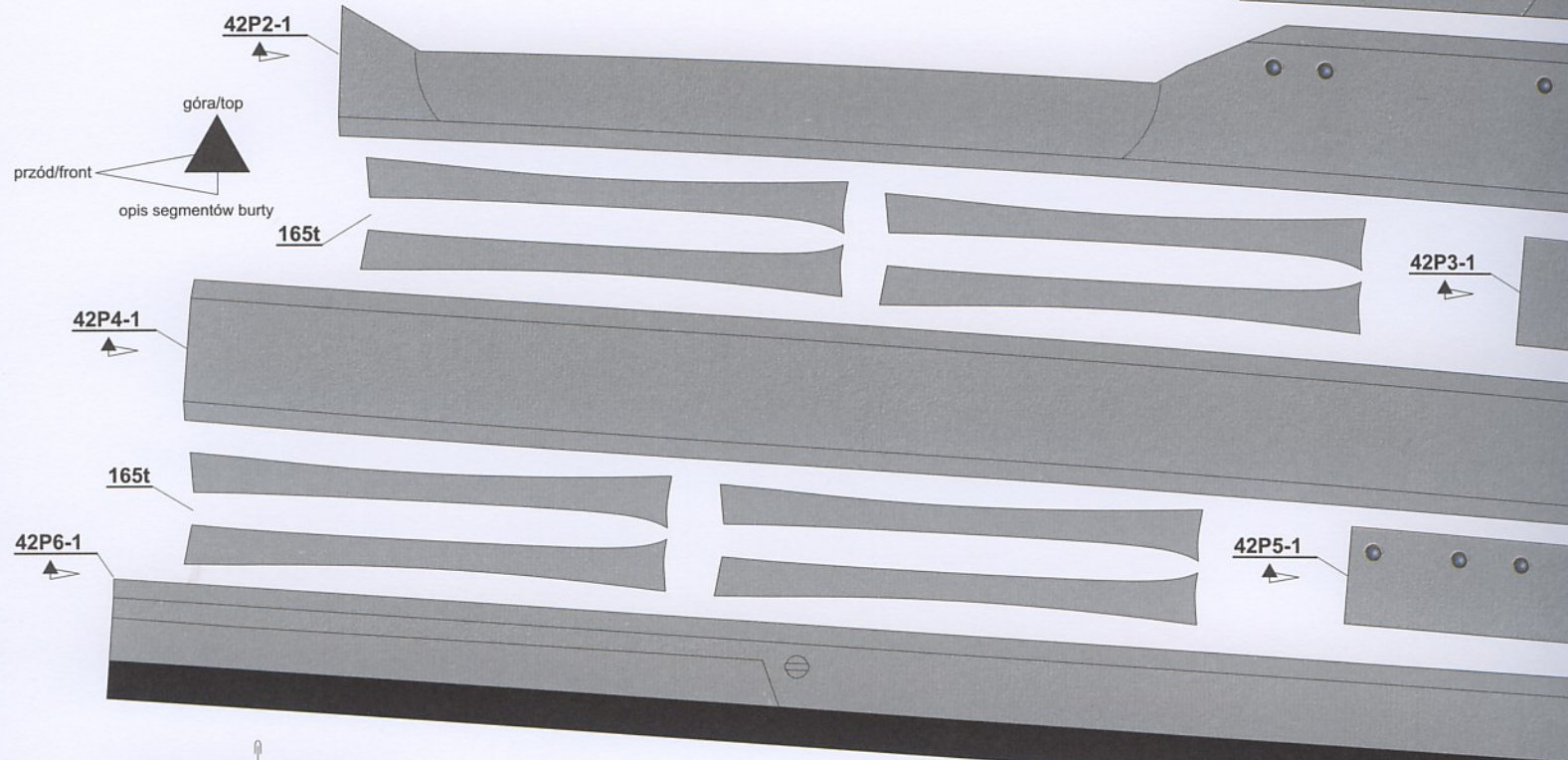
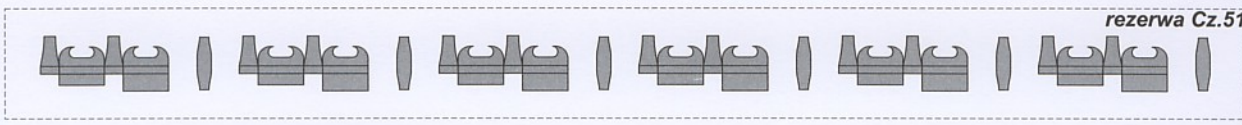



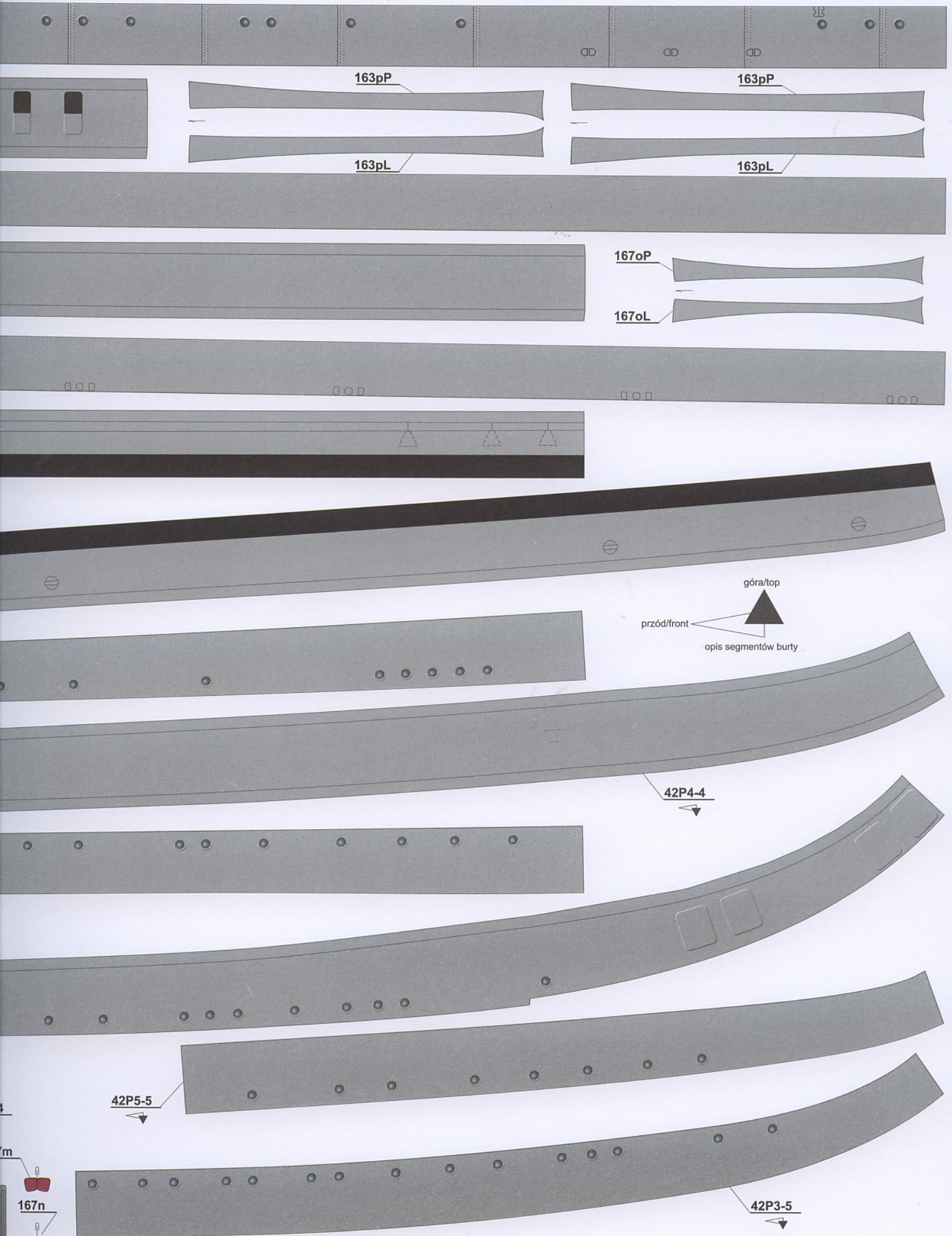

163pP

163pP

163pL

163pL

167oP

167oL

góra/top

przód/front

opis segmentów burty

42P4-4

42P5-5

42P3-5

167n

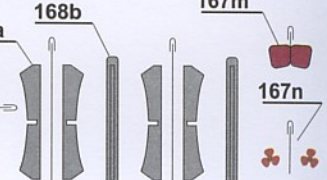
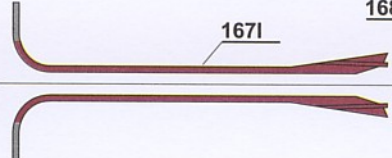
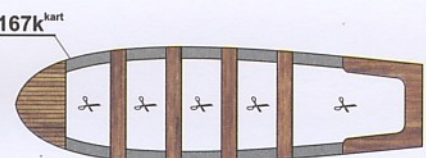
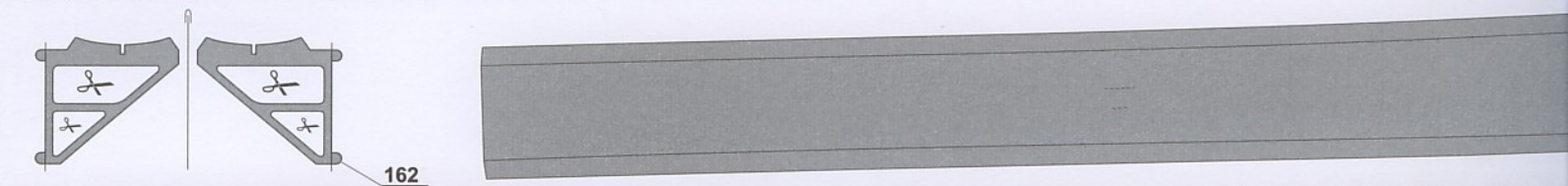
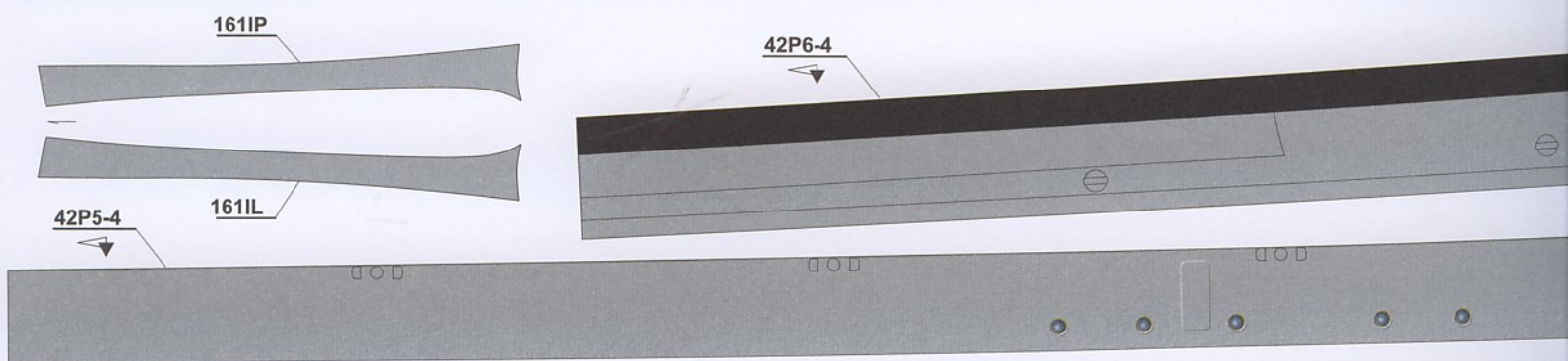
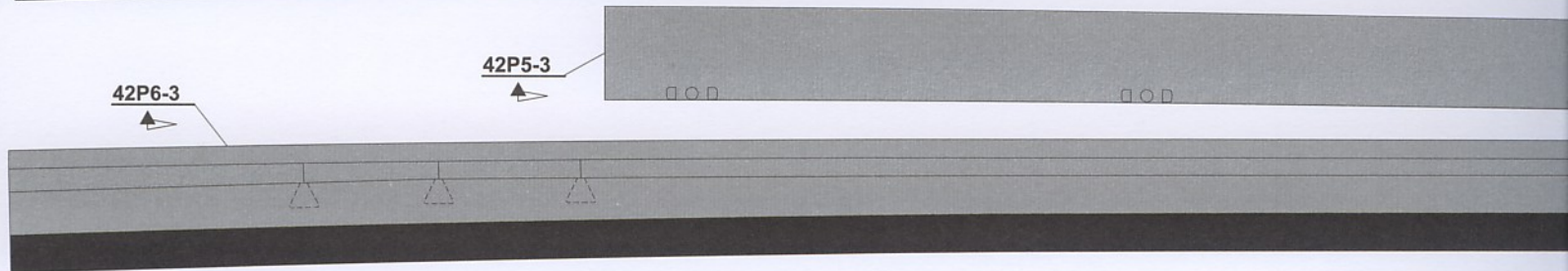
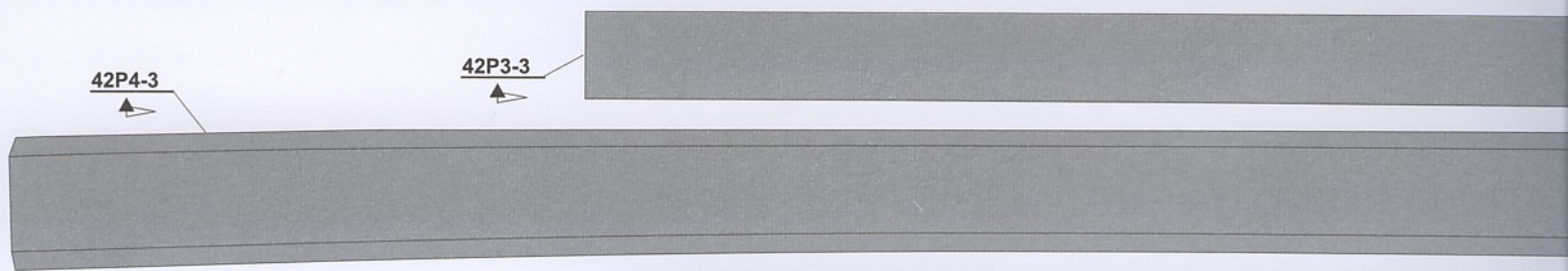
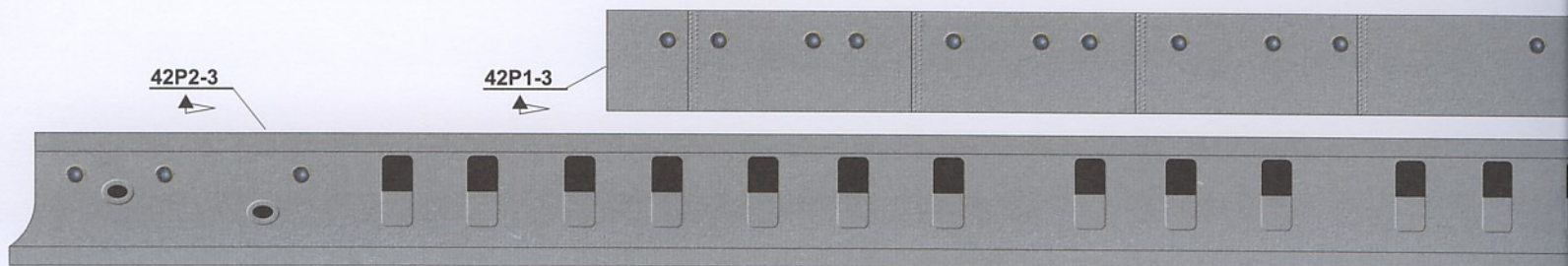

20P

21P

43cL

22P

23P

24P

161a

161b

161c

161d

161e

161f

161g<sup>kart</sup>

161h

20L

21L

22L

23L

24L

43cP

43bP

167a

167b

167c

167d

167e

167f

167g<sup>kart</sup>

167h

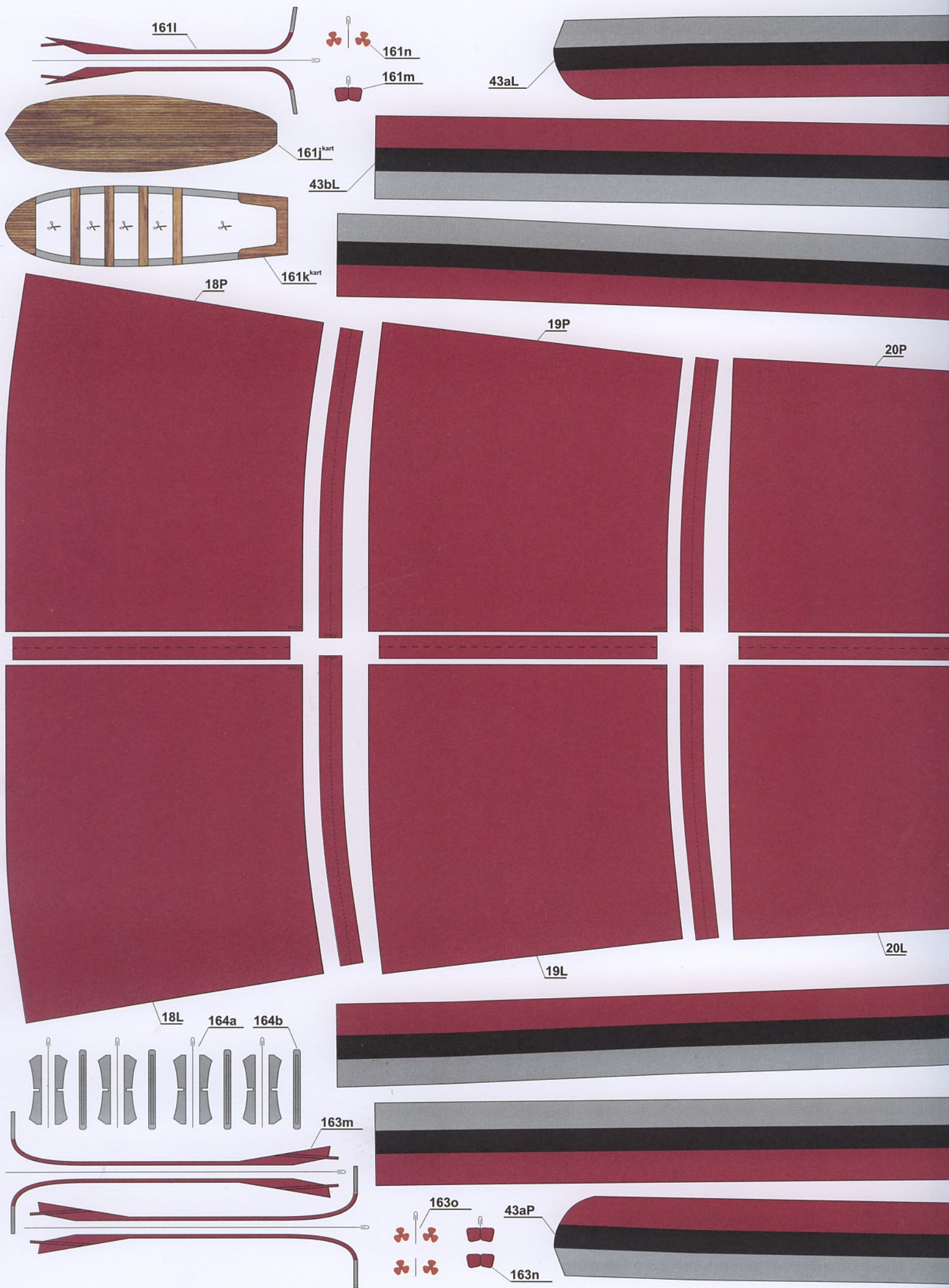

15P

16P

163<sup>l</sup>kart

17P

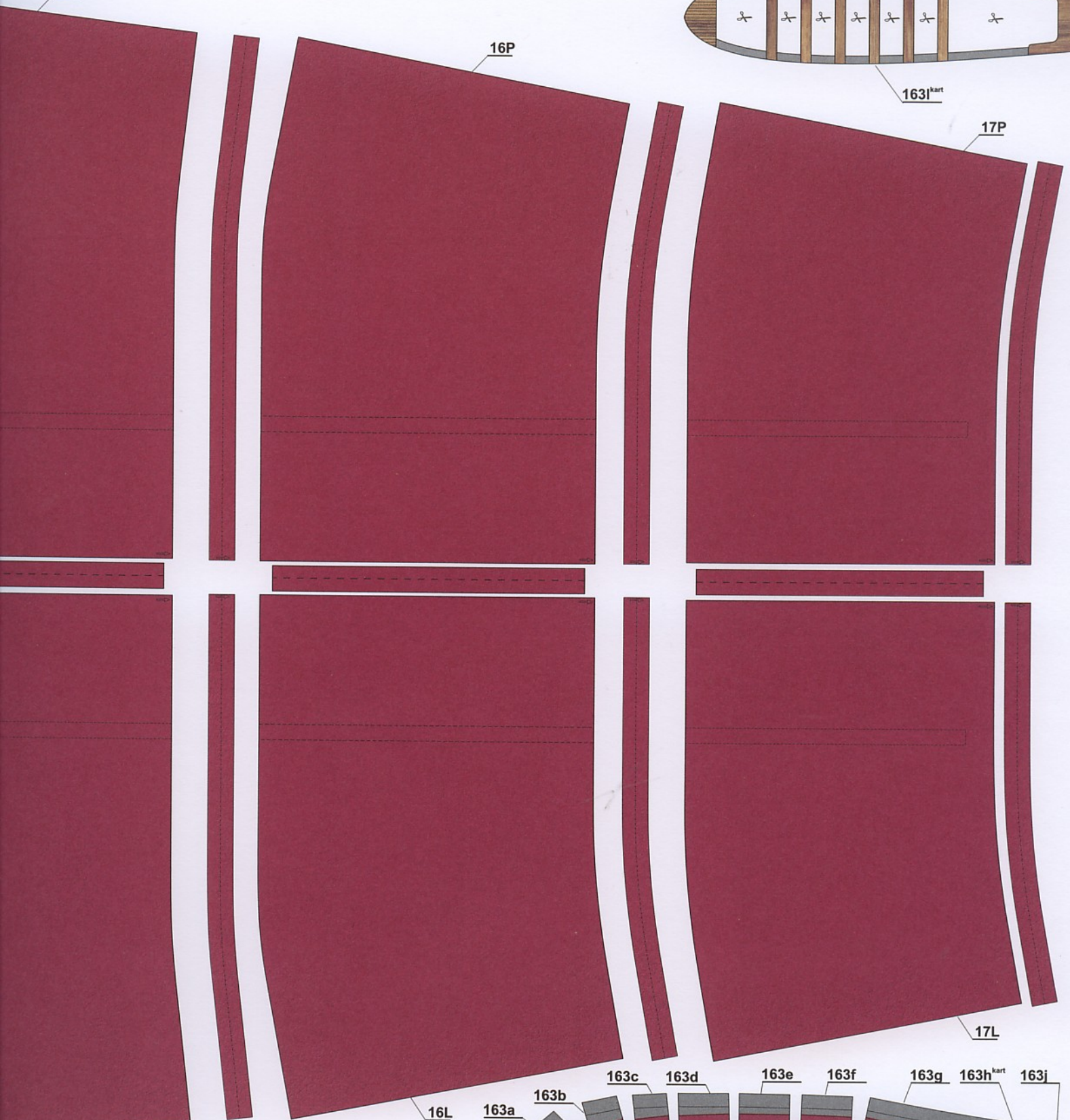

163<sup>l</sup>kart

16L

163a

163b

163c

163d

163e

163f

163g

163<sup>h</sup>kart

163j

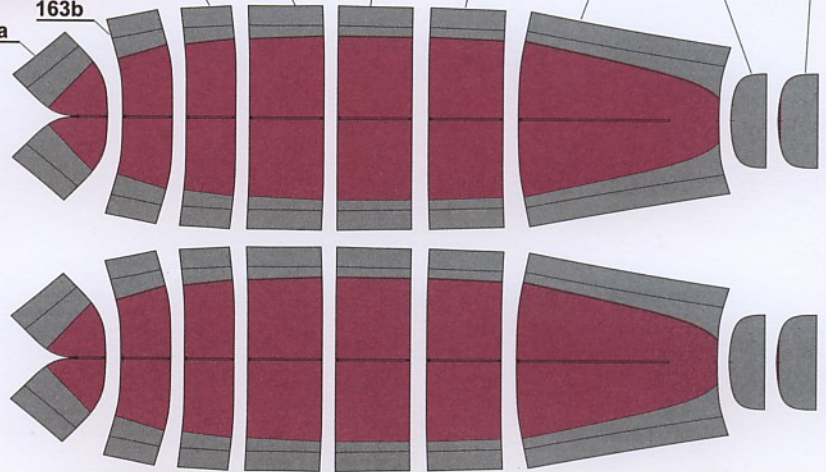
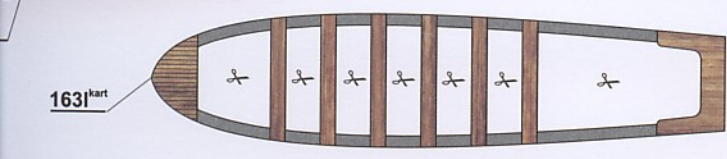

26L

26P

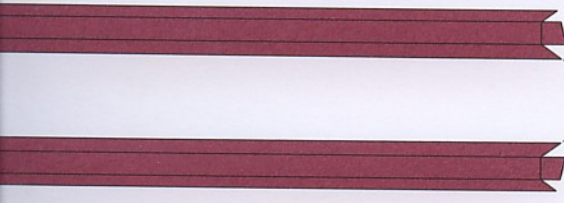

13P

14P

15P

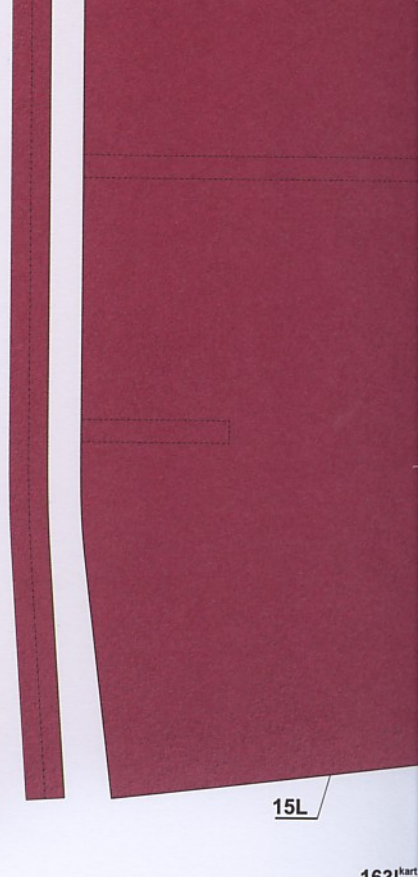
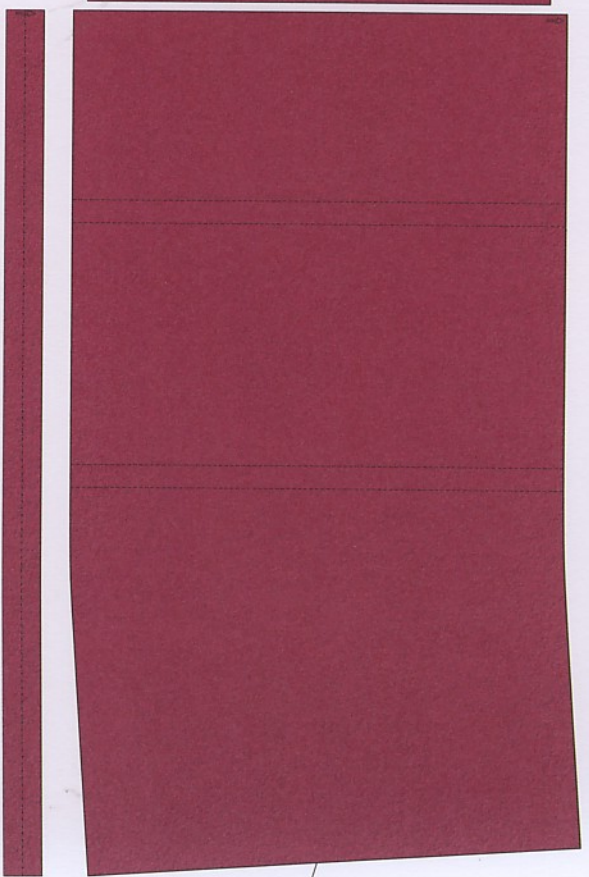
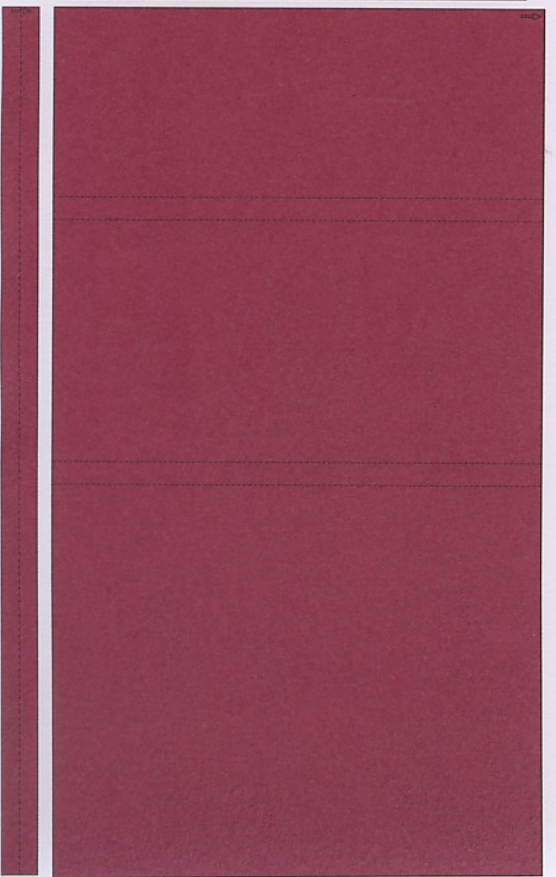
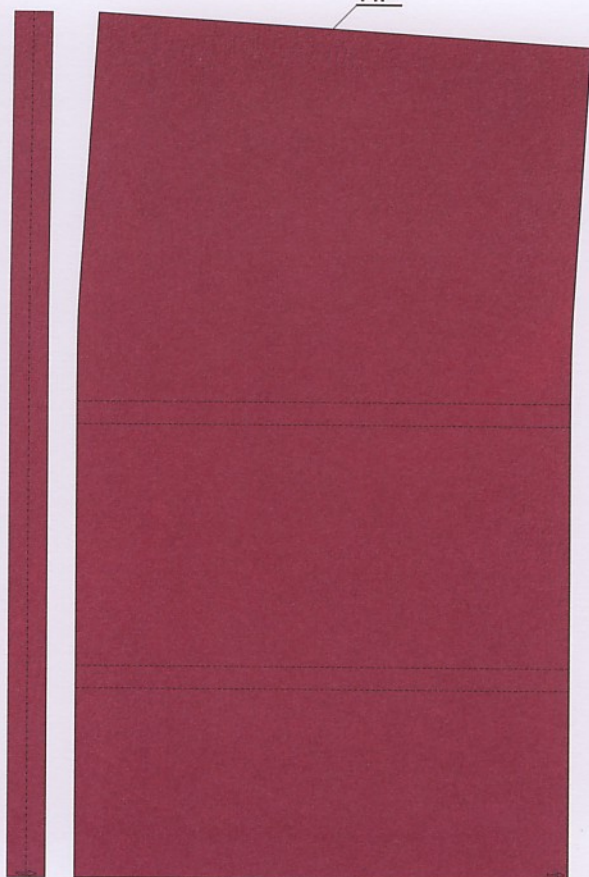
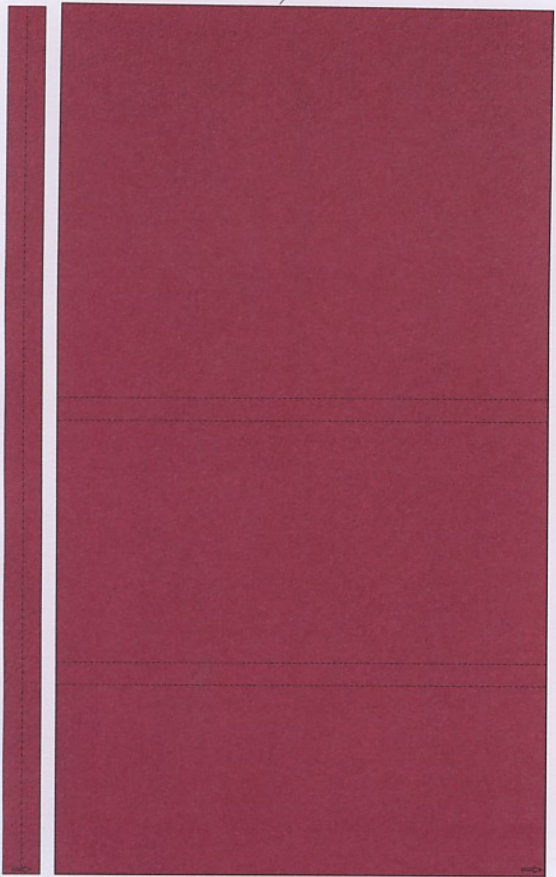

13L

14L

15L

1631

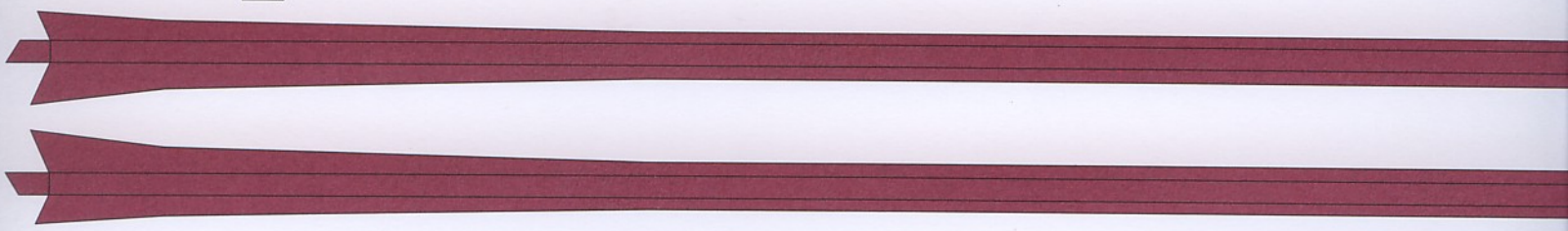

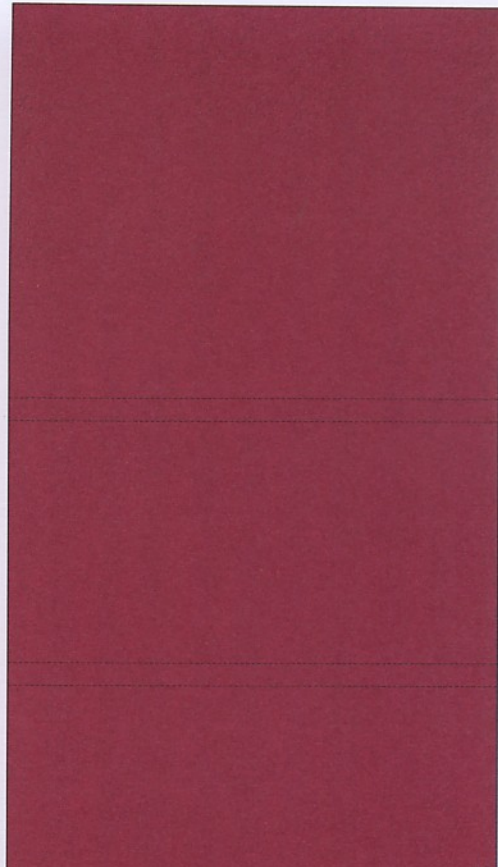
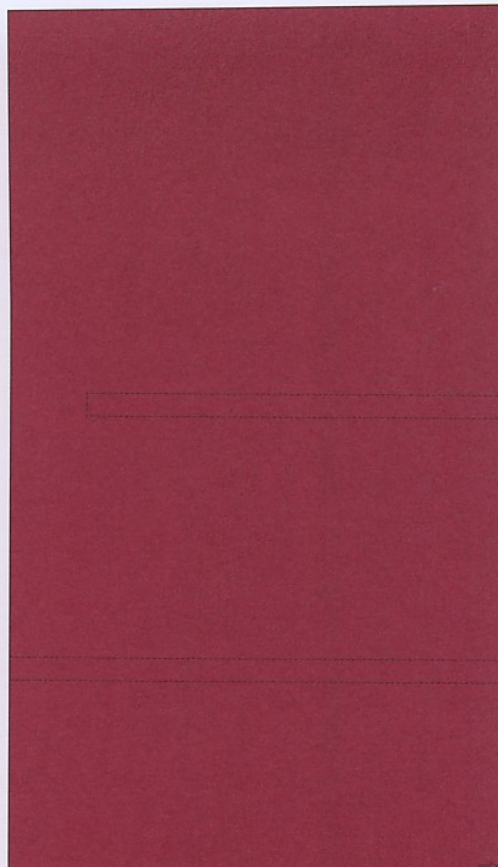
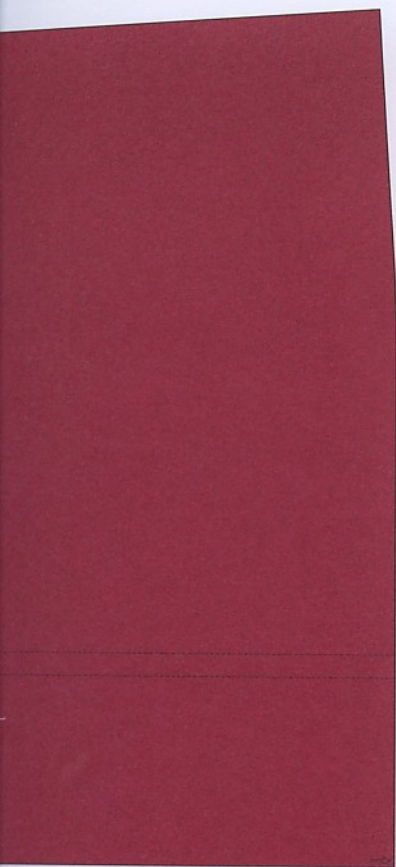

11L

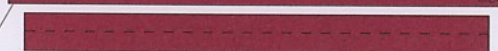

12L

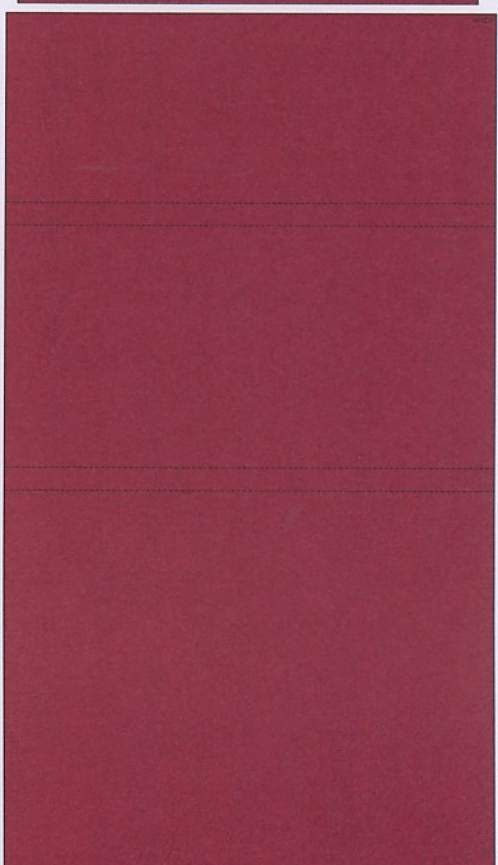
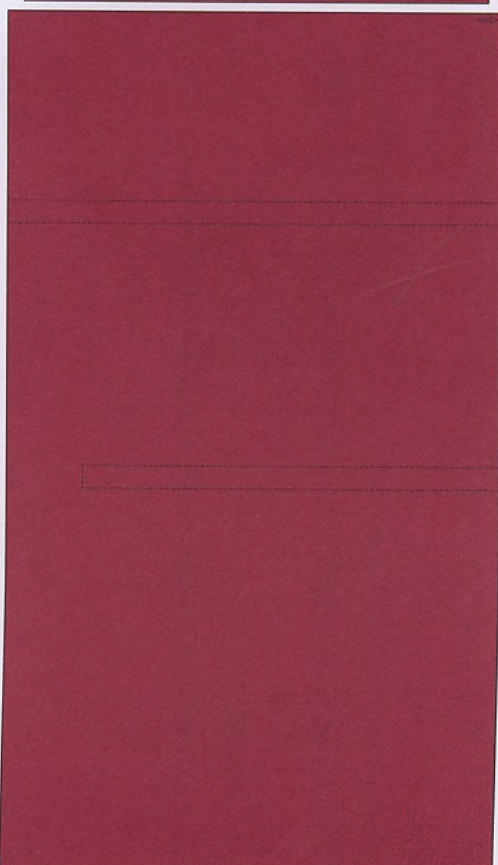
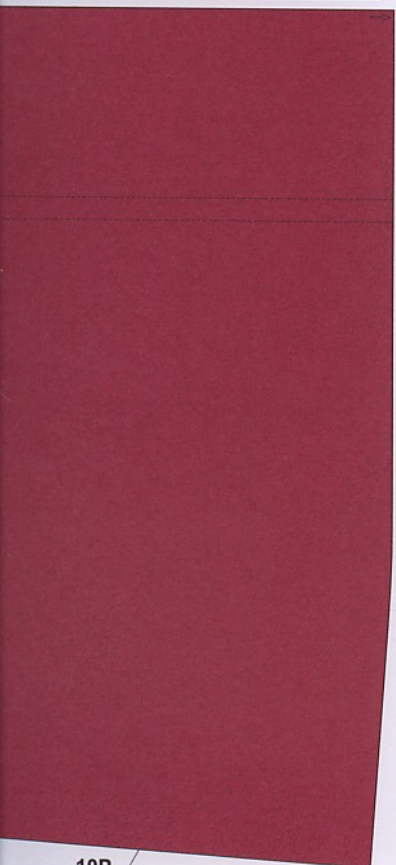

10P

11P

12P

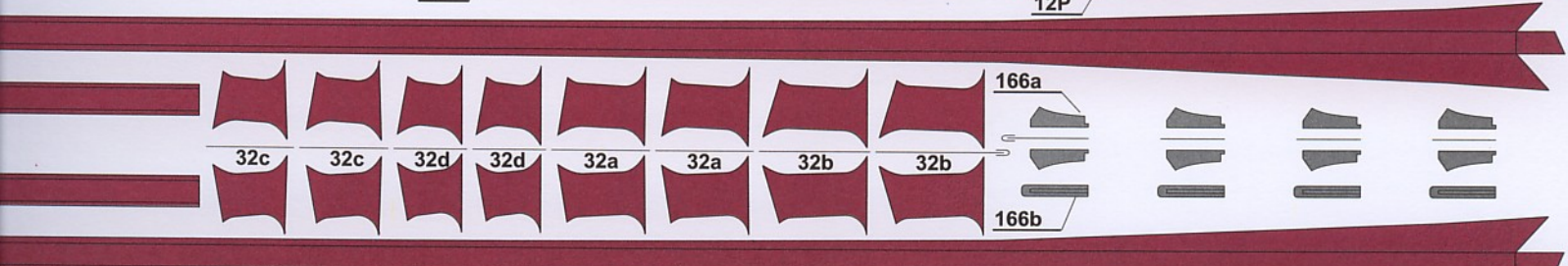

32c

32c

32d

32d

32a

32a

32b

32b

166a

166b



163k<sup>kart</sup>

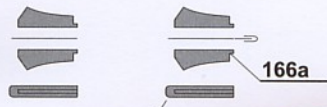

166b

166a

9L

10L

8L

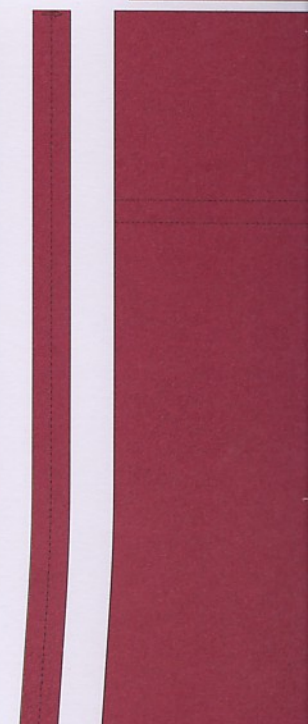
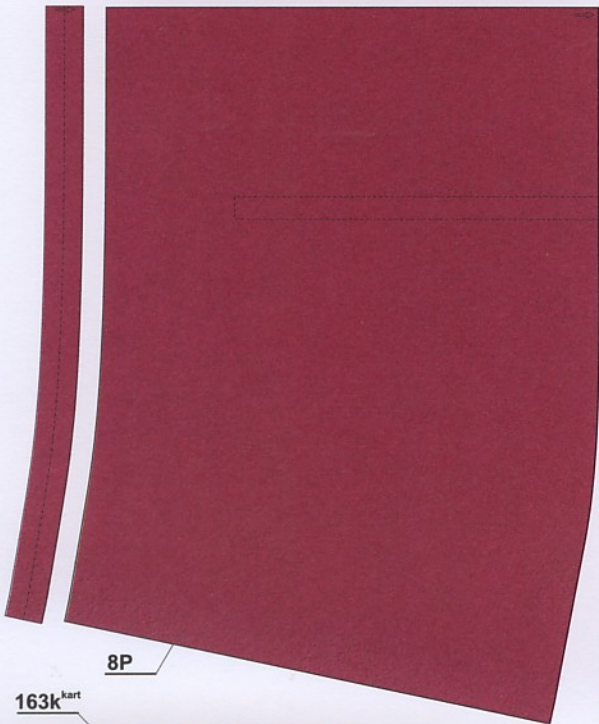

8P

9P

163k<sup>kart</sup>

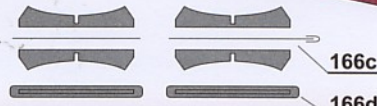

166c

166d

27aL

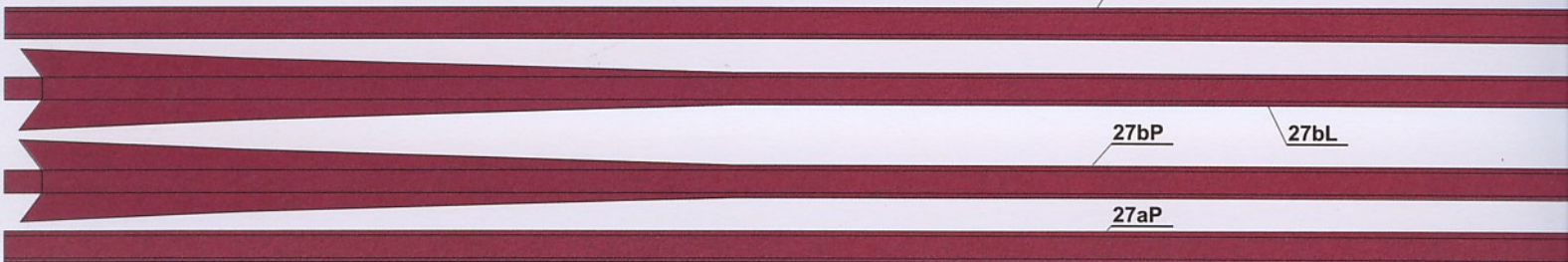

27bP

27bL

27aP

10P



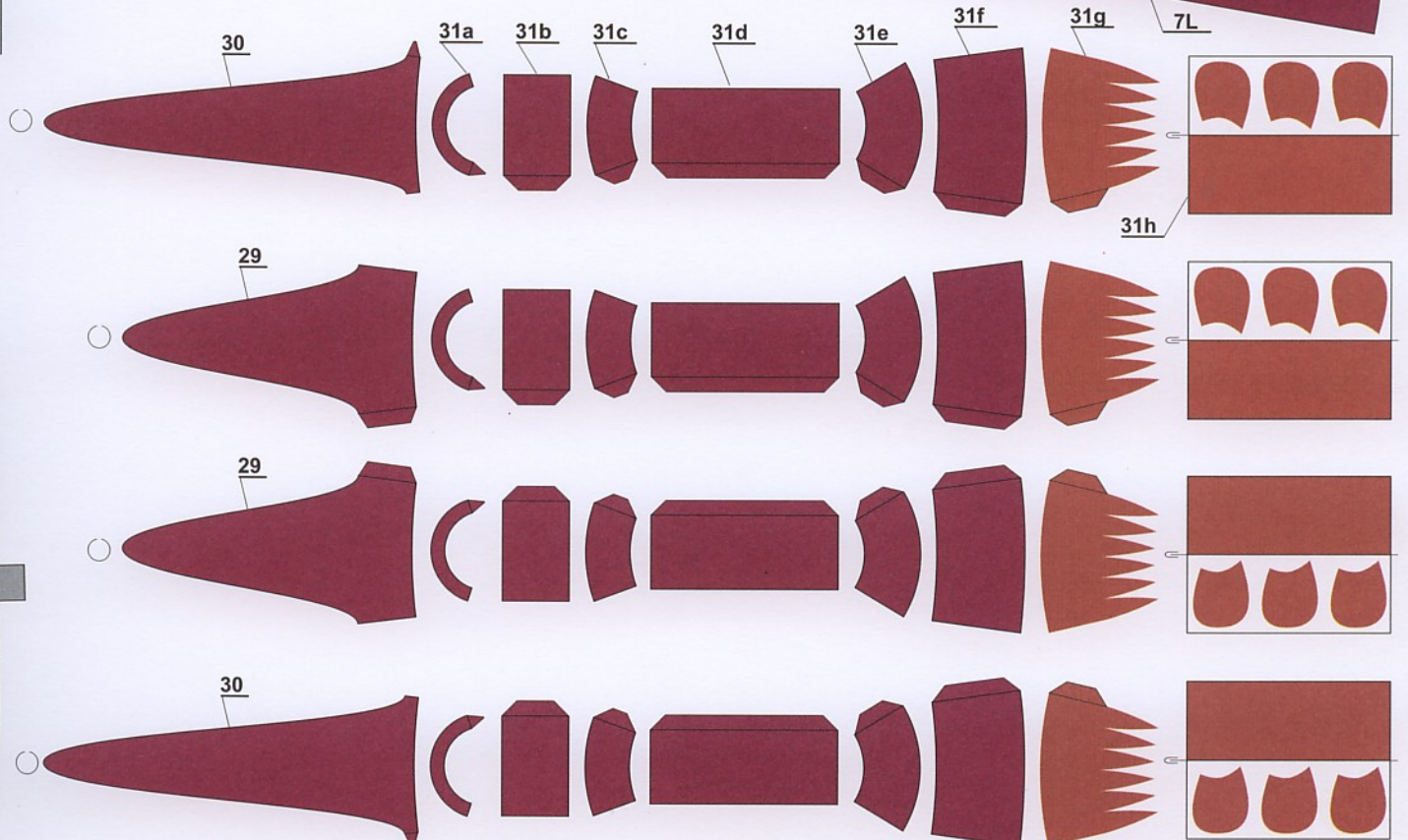
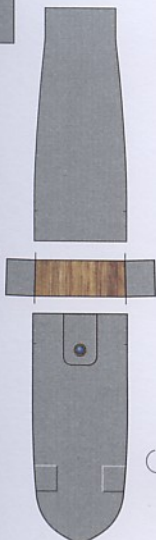
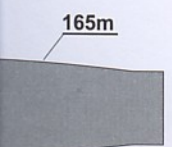
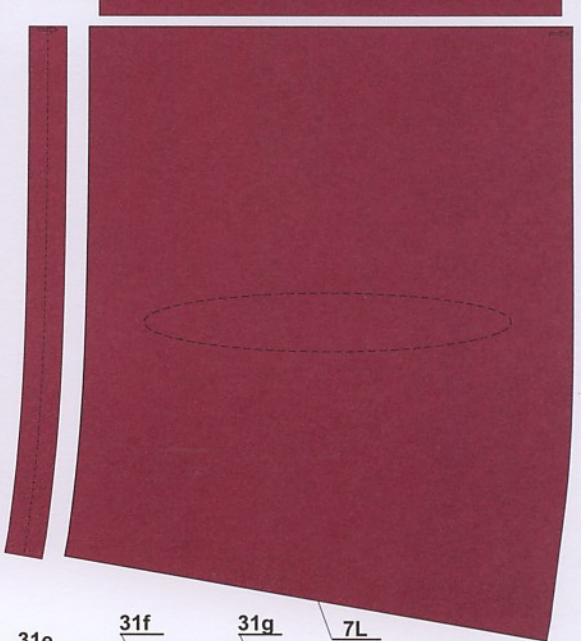
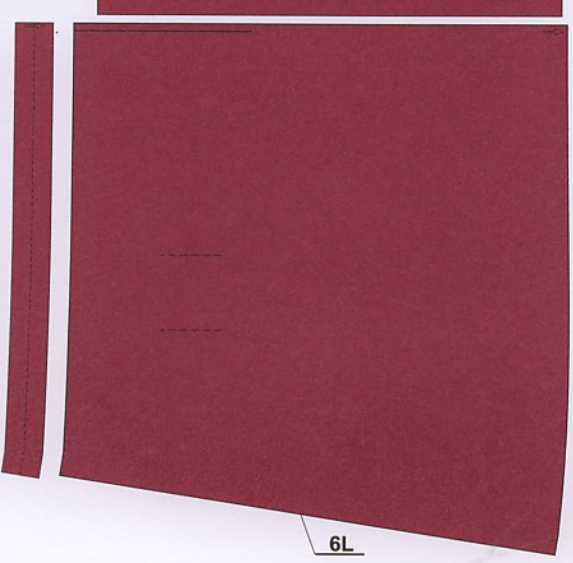
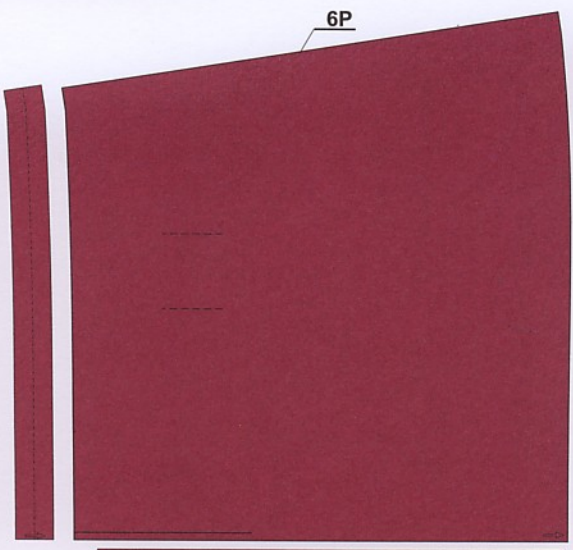
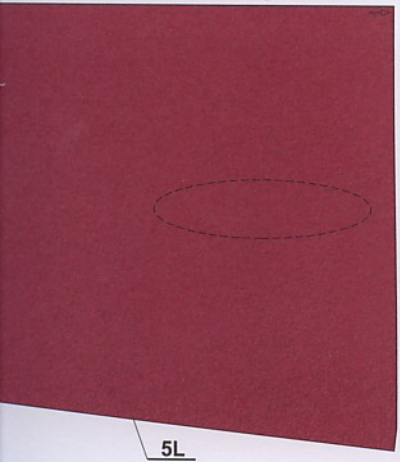
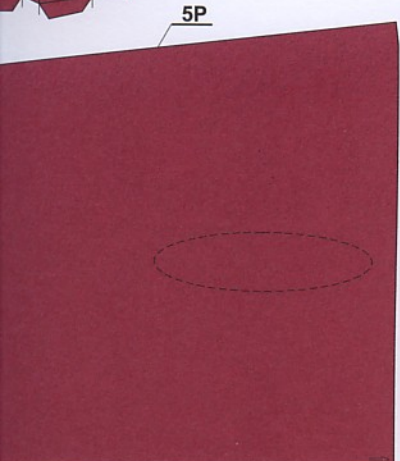
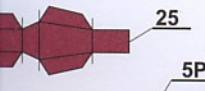

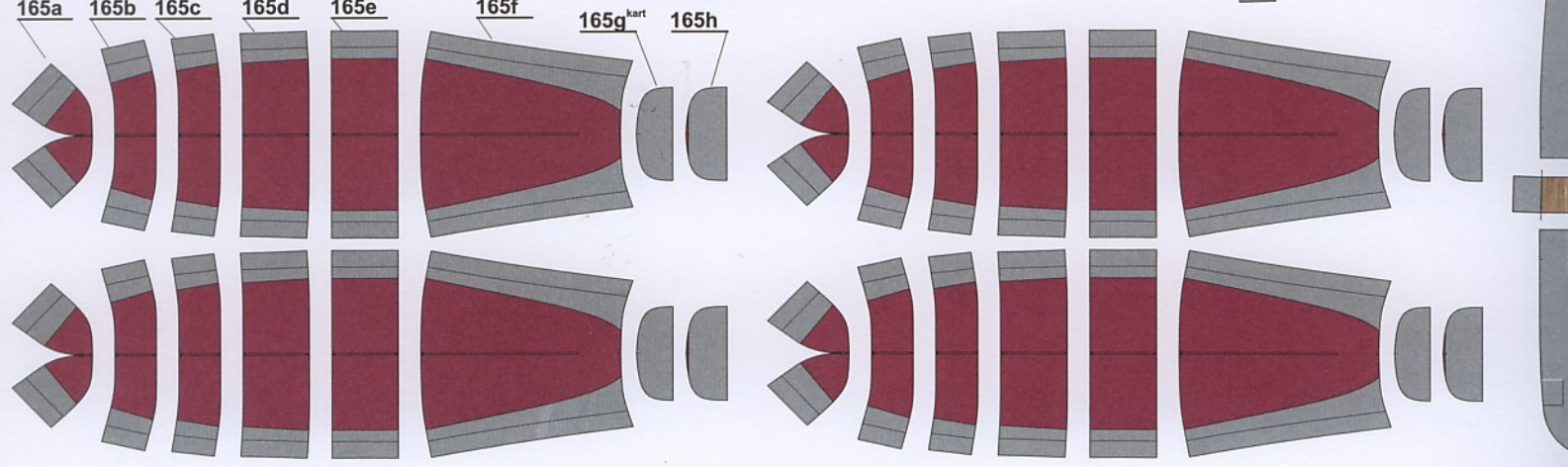
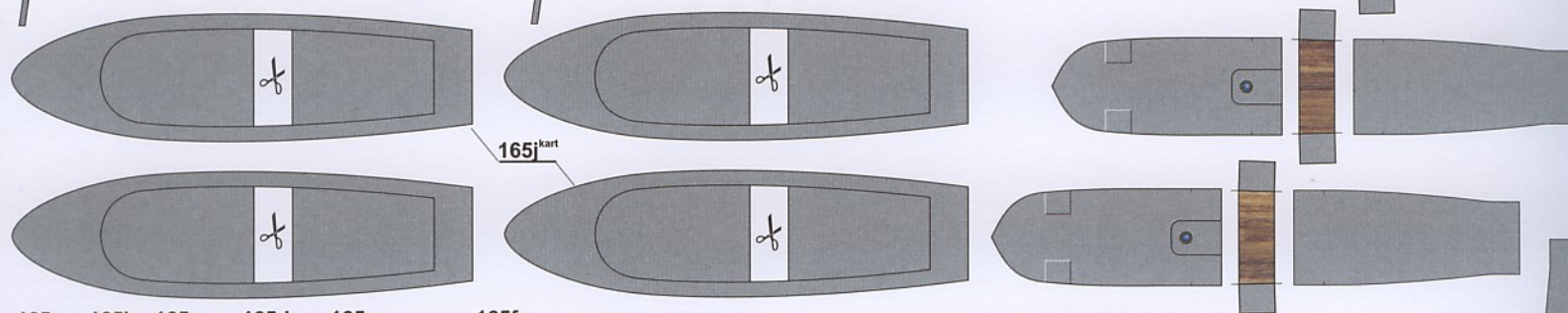
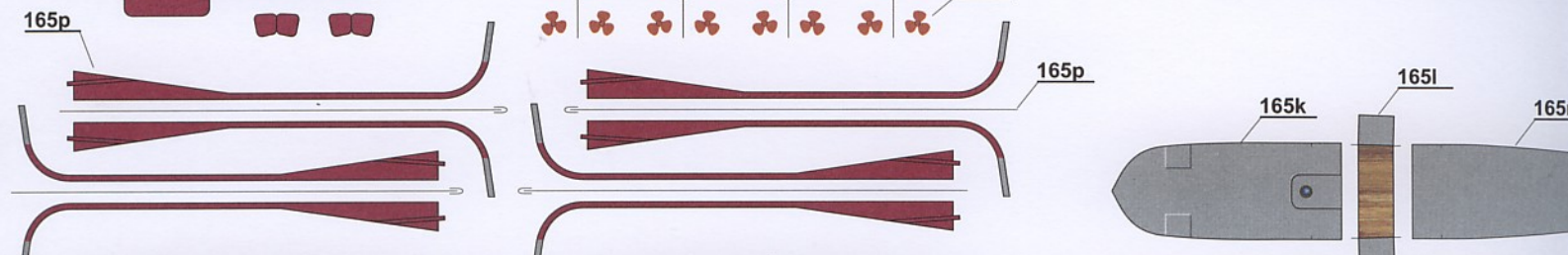
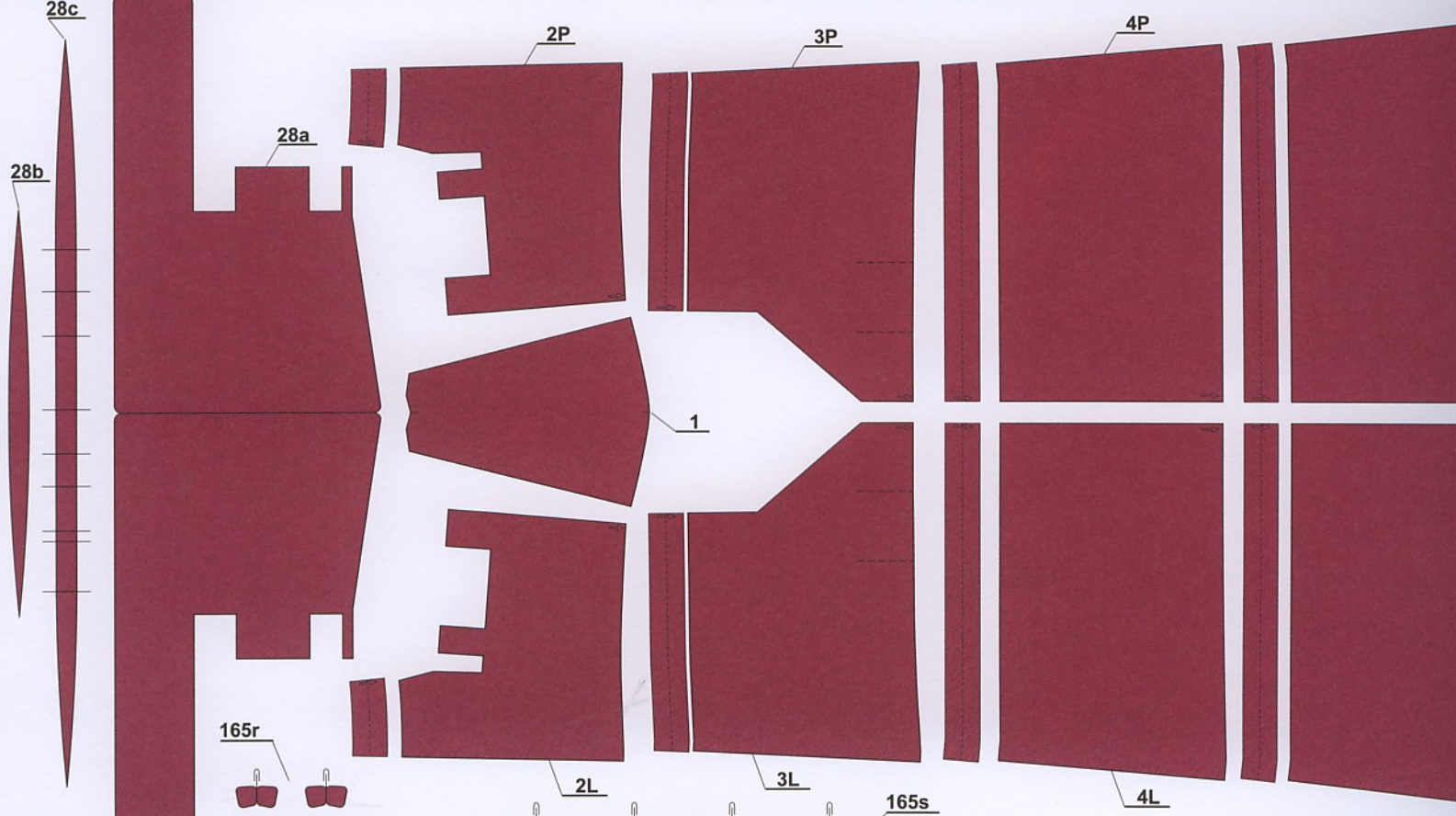

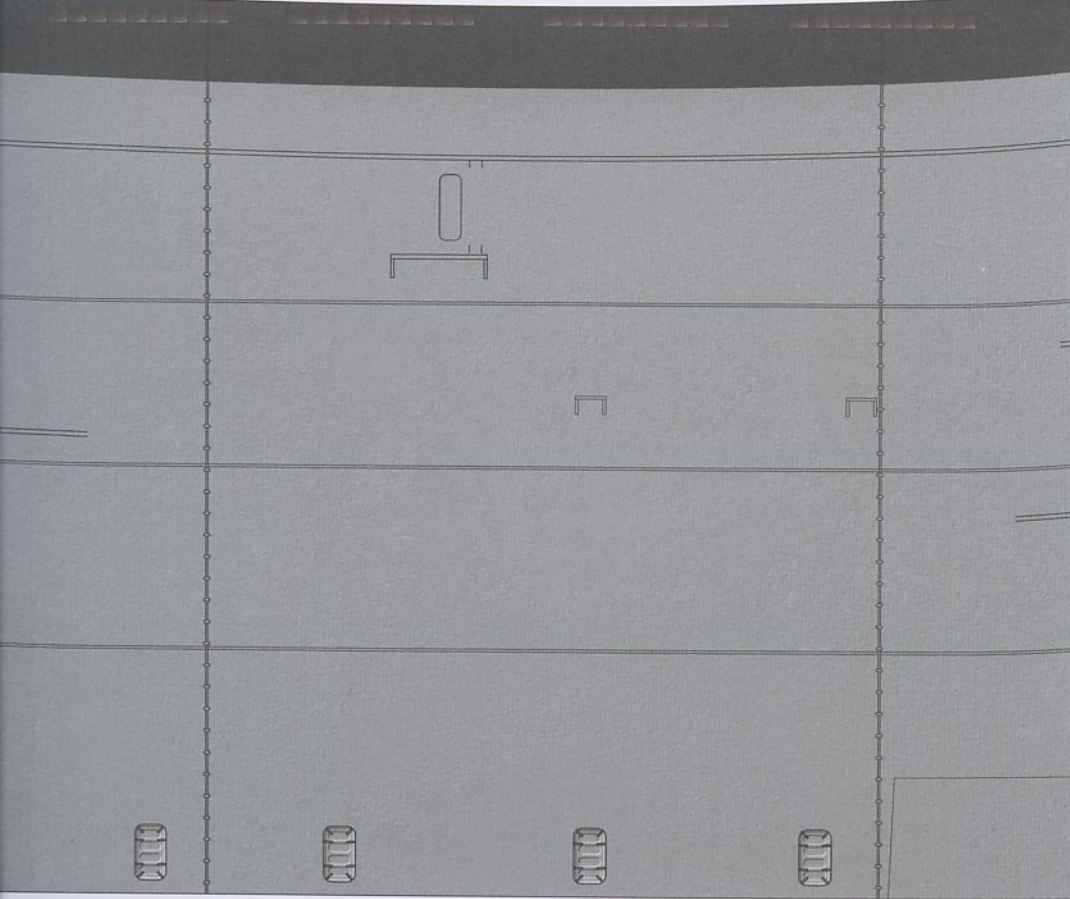
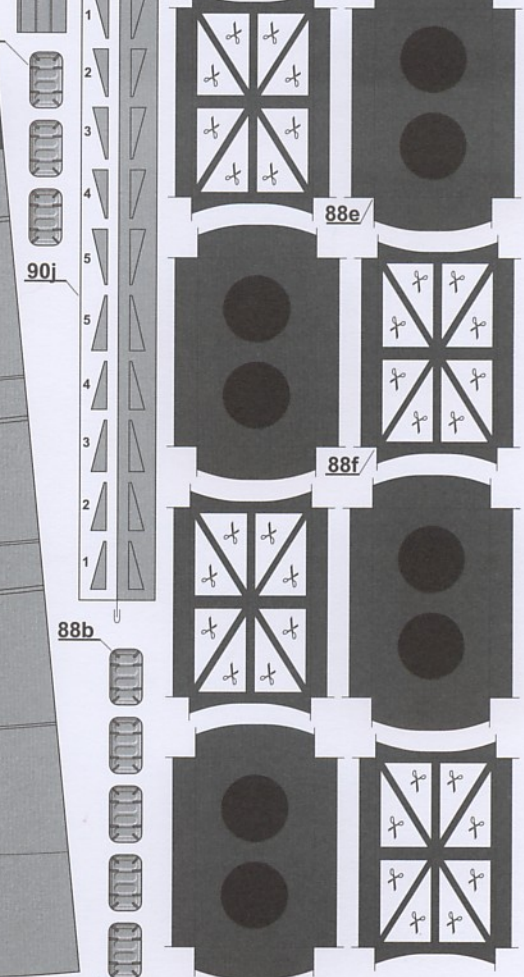
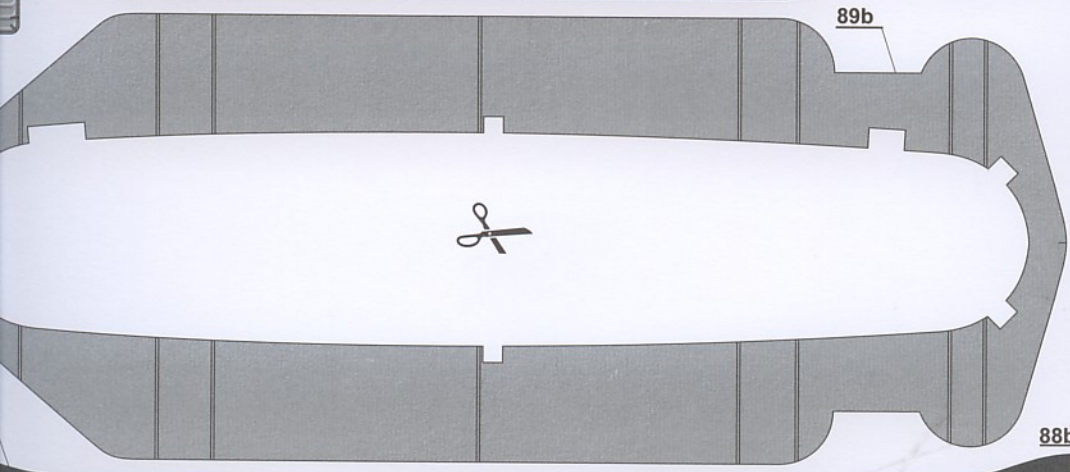
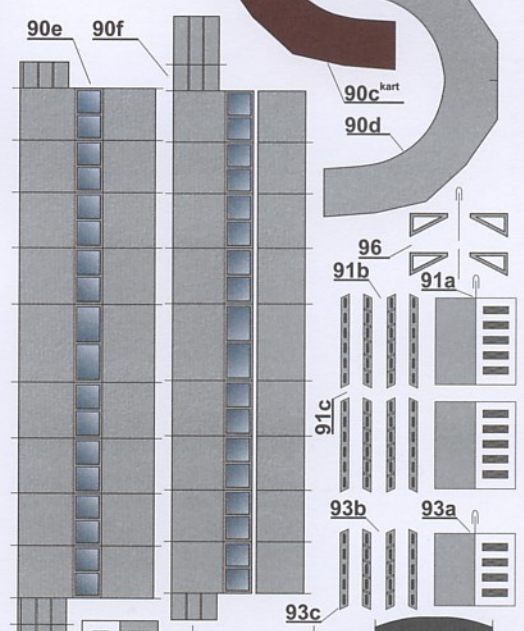
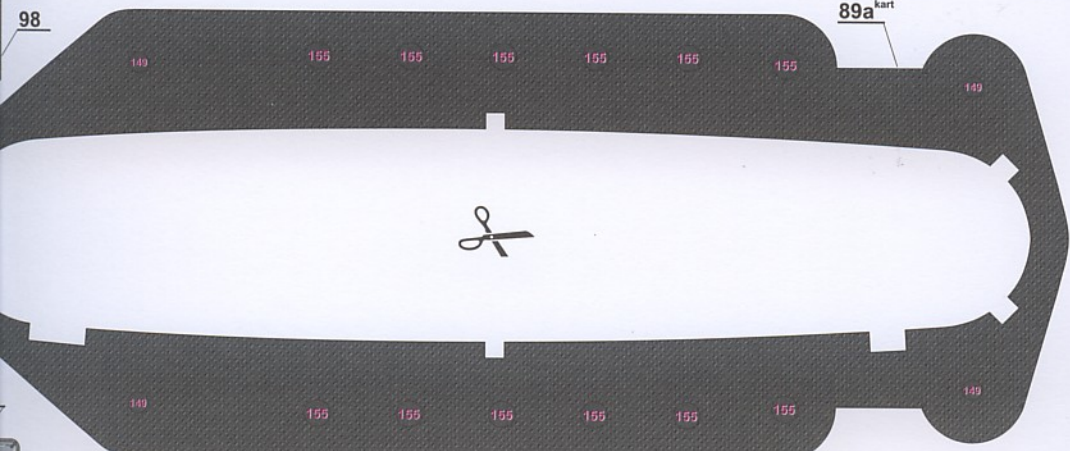
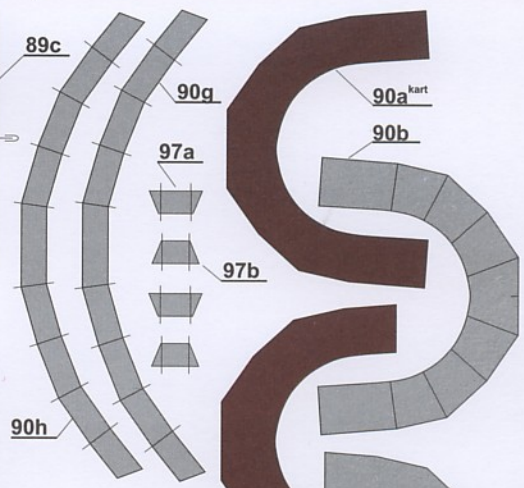
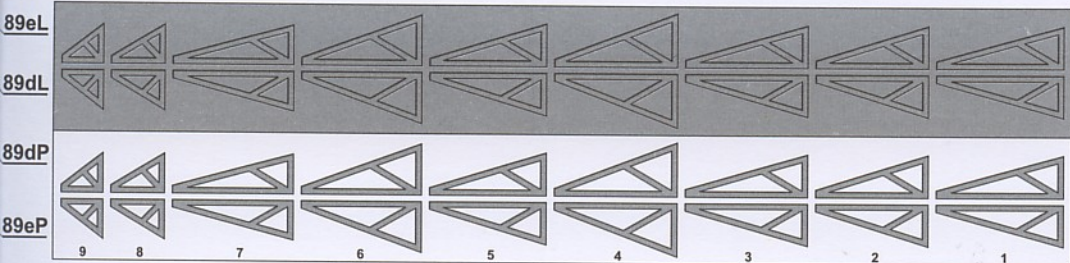

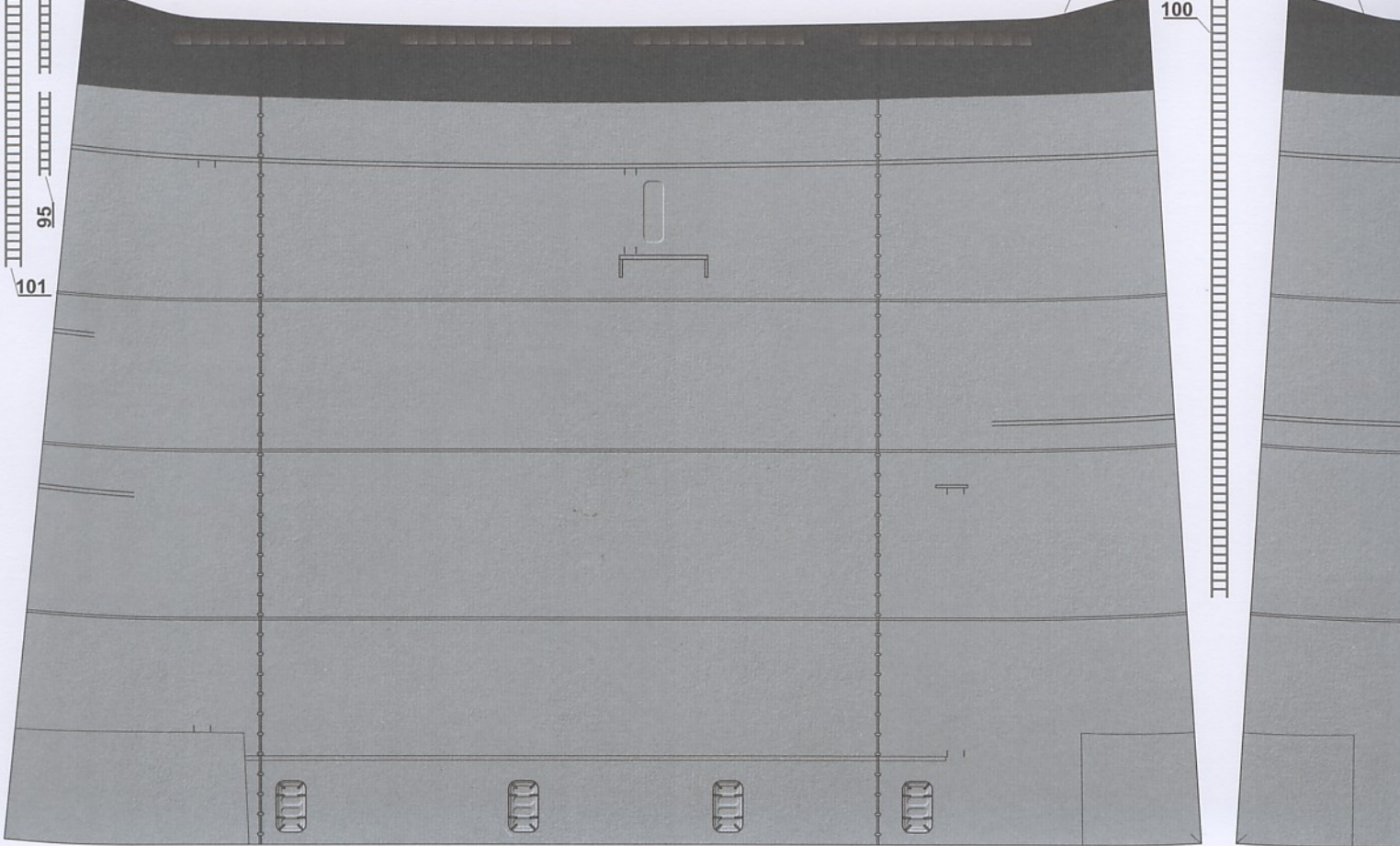
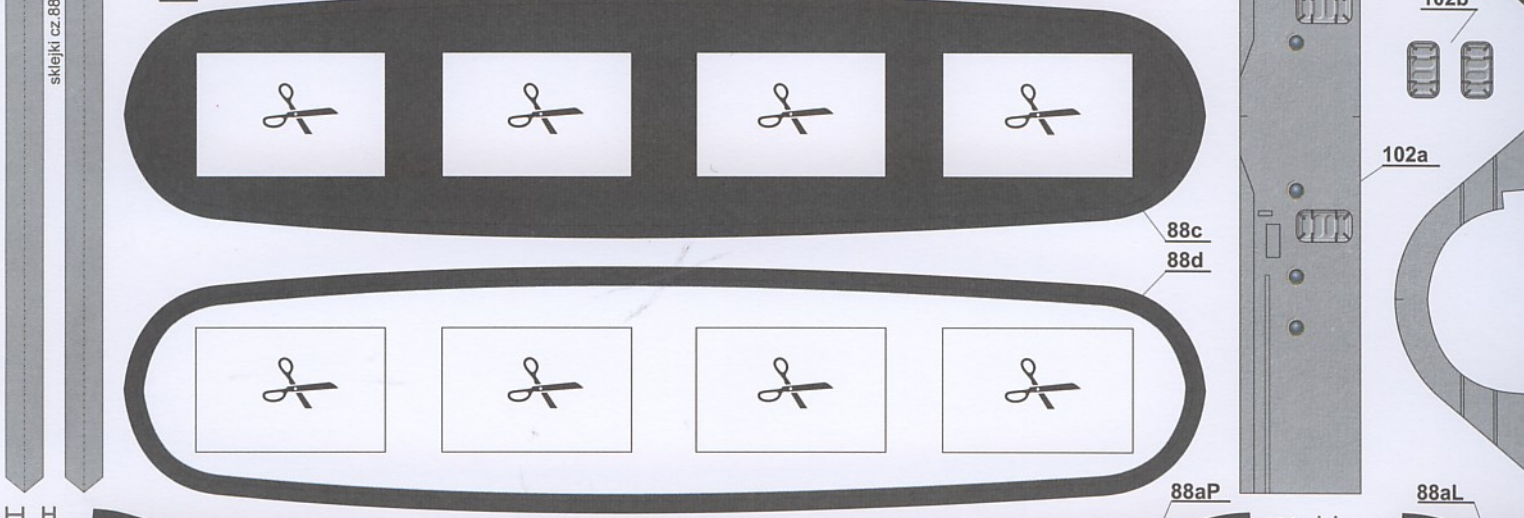
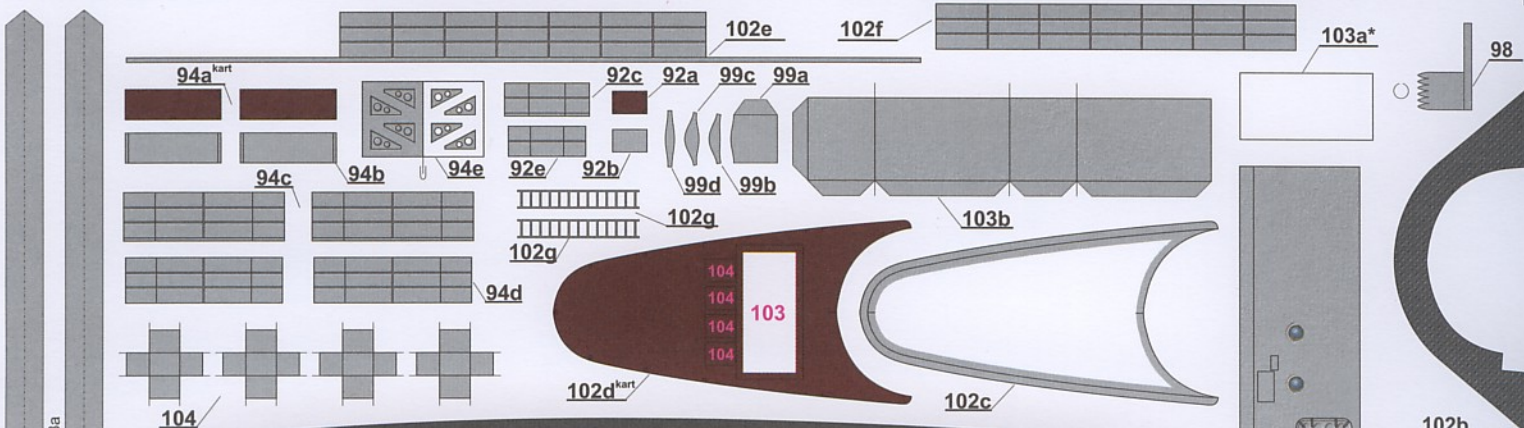
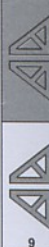
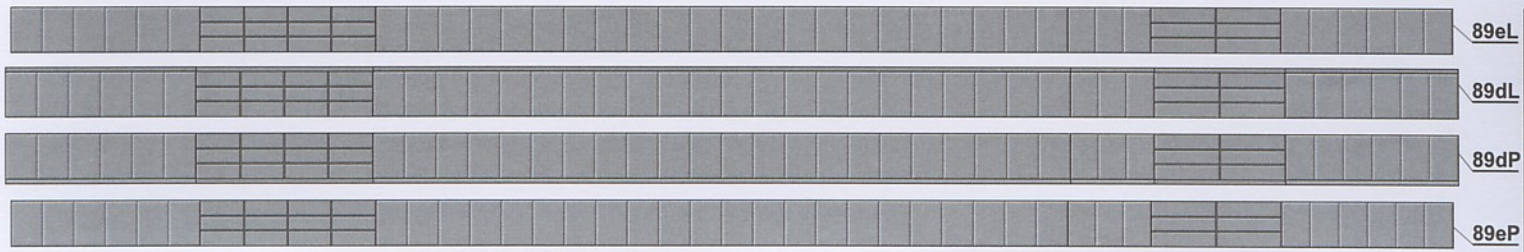

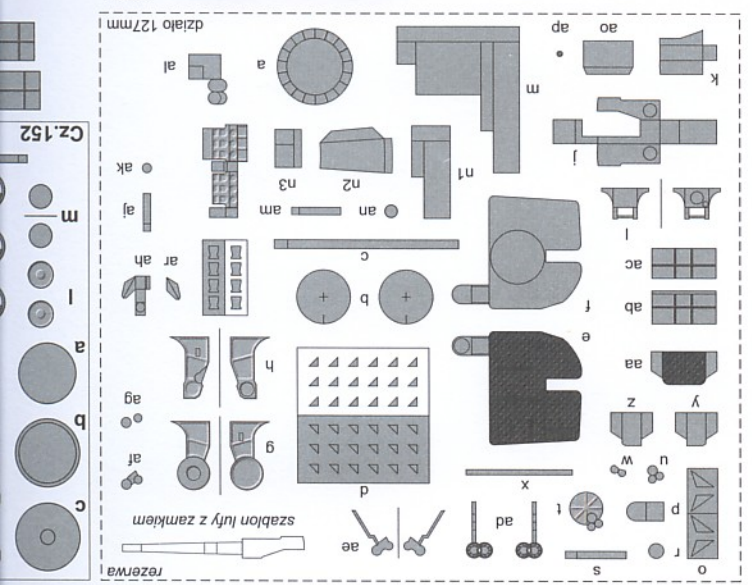
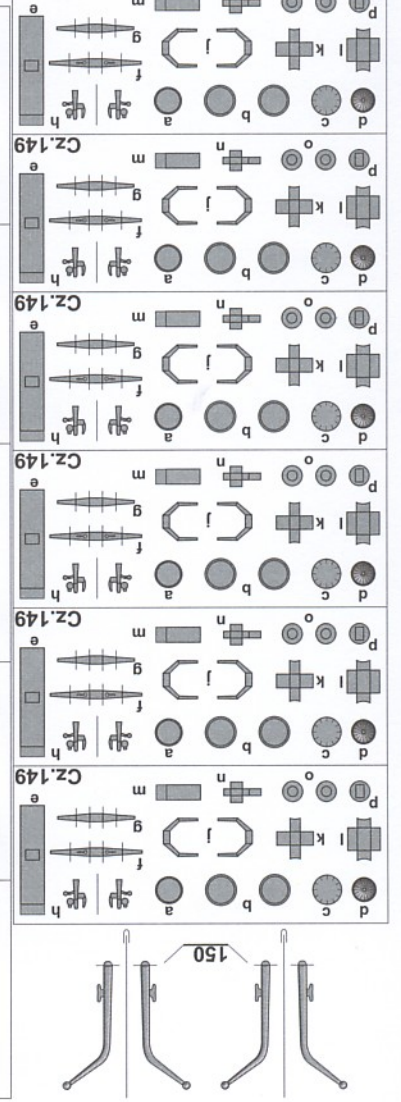
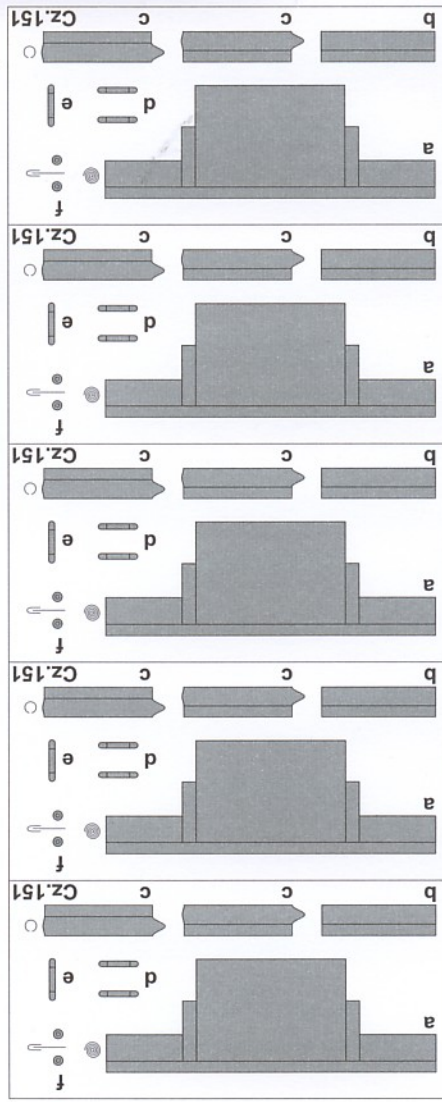
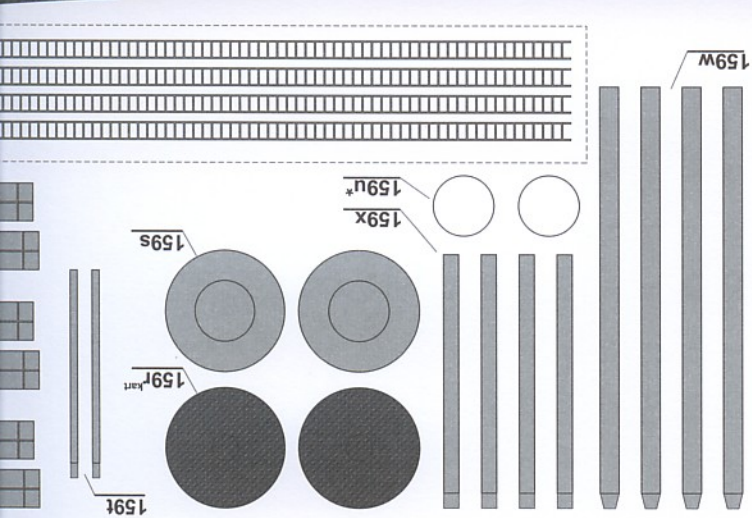
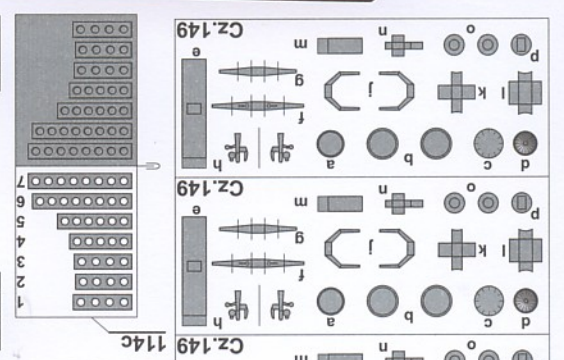
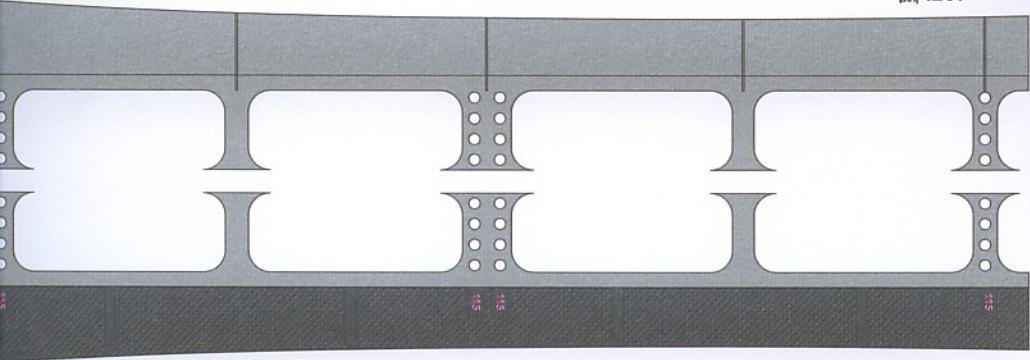
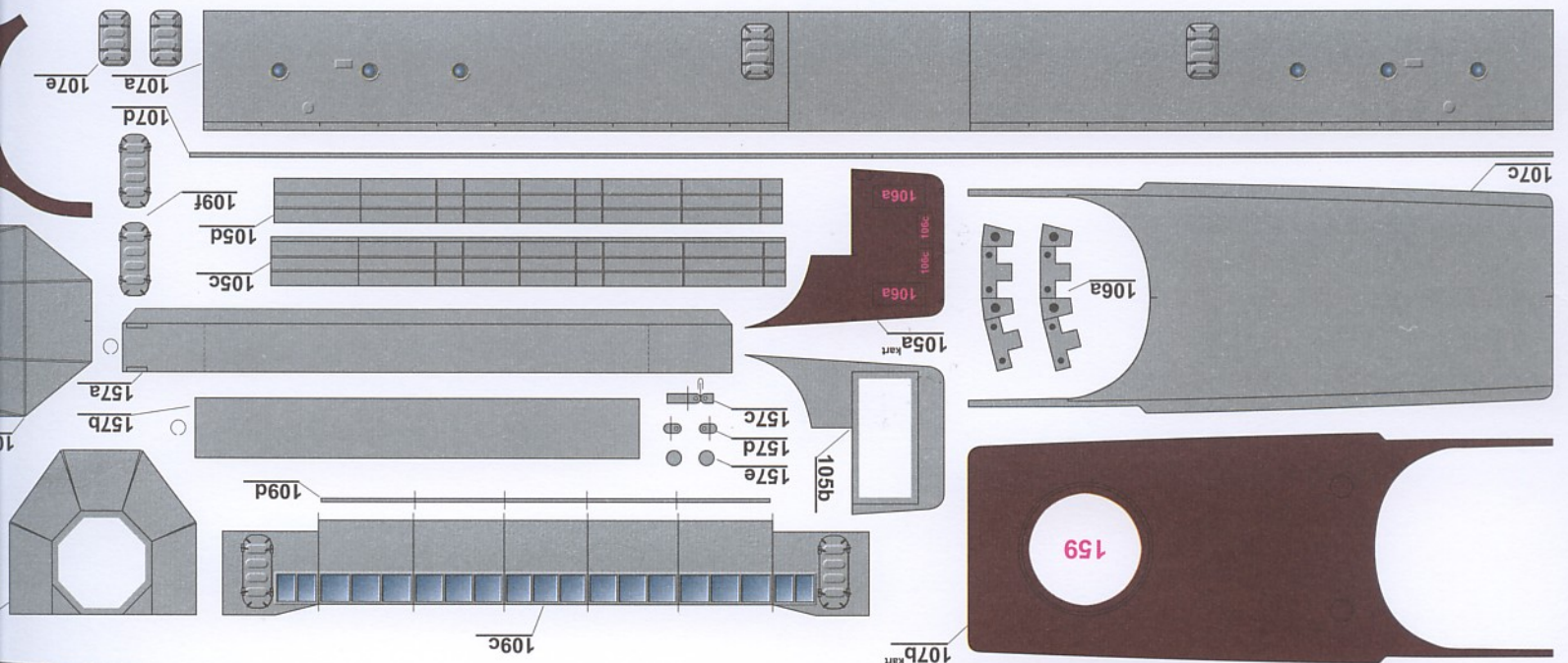

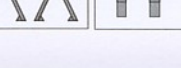
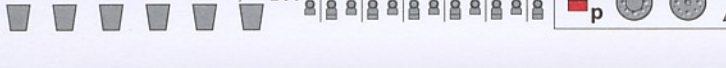
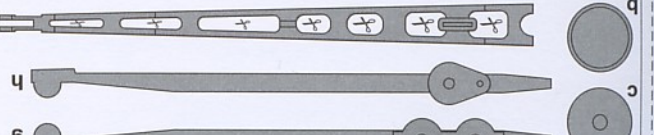
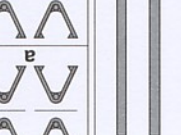
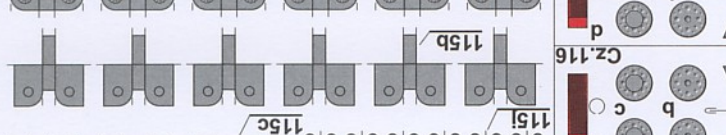
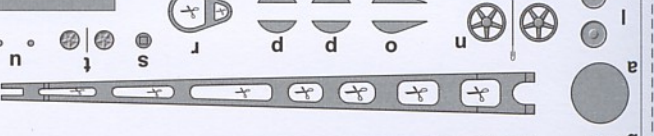
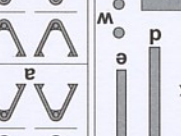
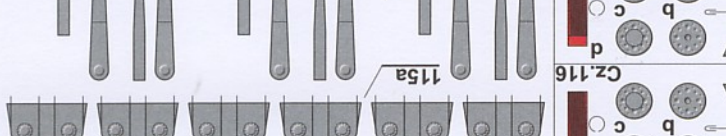
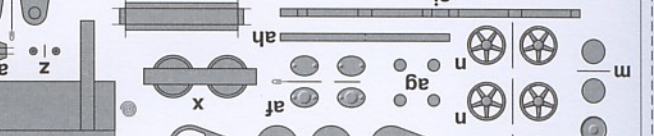
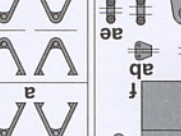
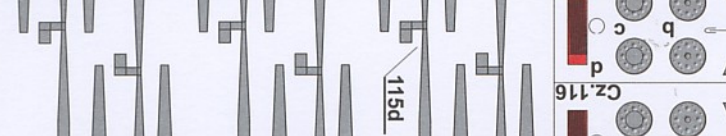
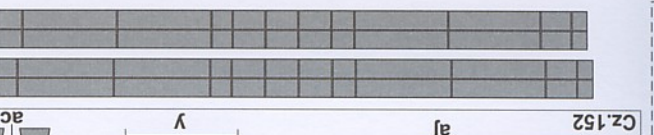
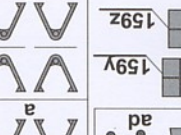
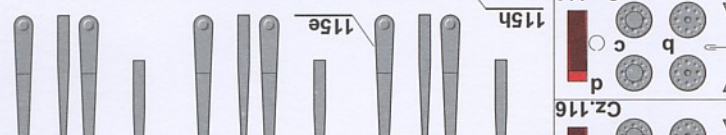
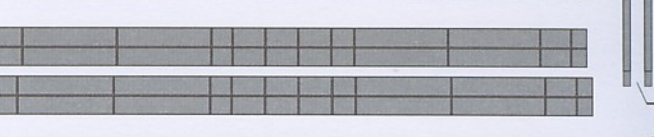
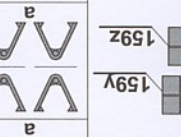
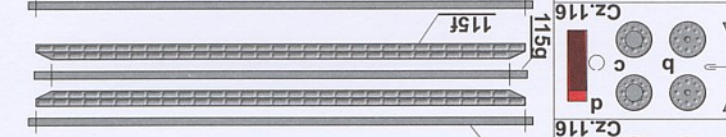
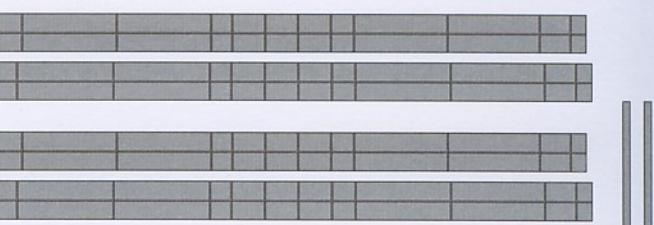
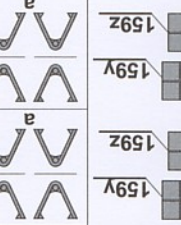
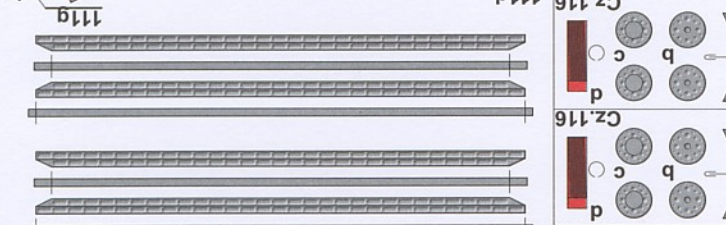
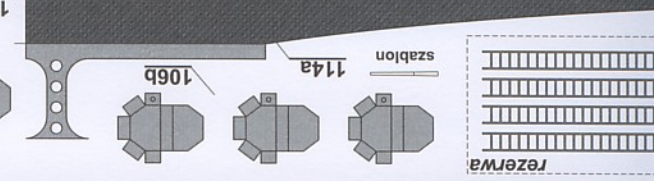
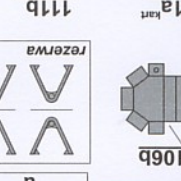
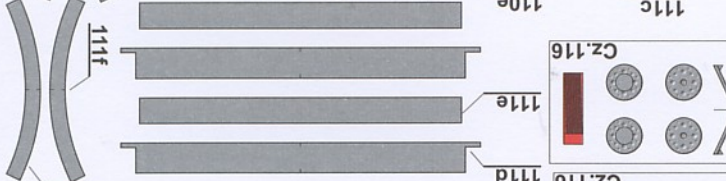
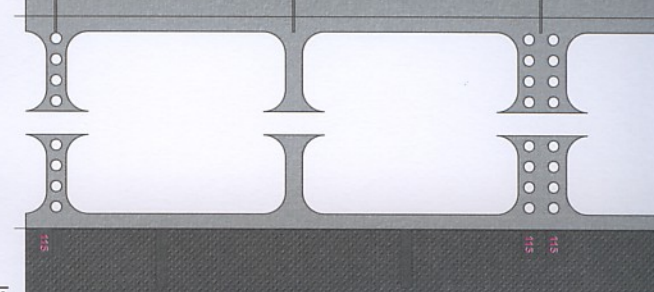
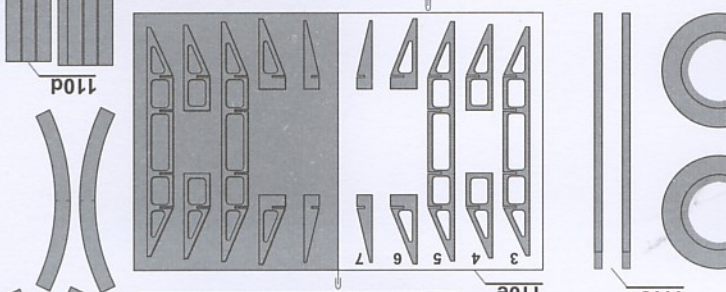
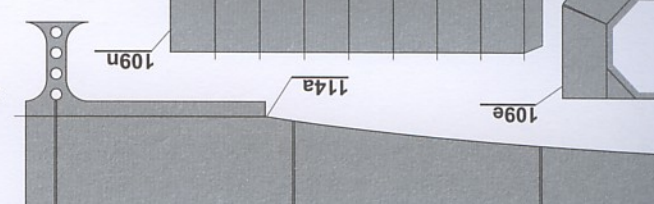
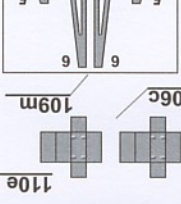
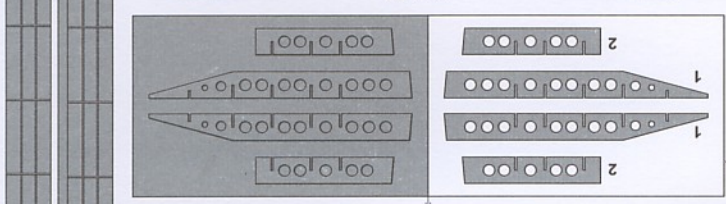
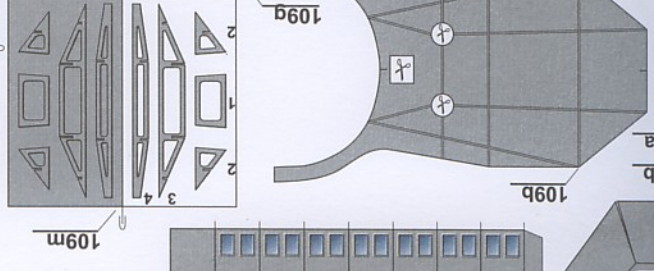
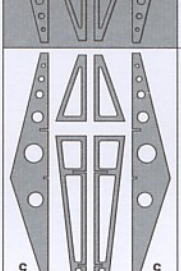
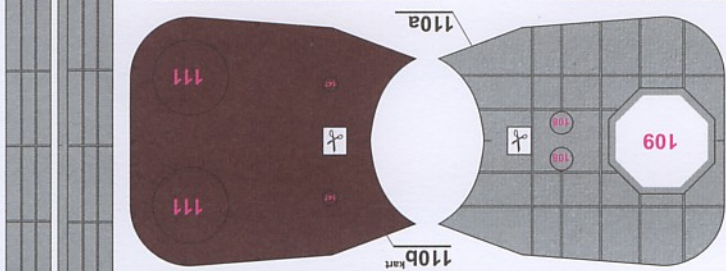
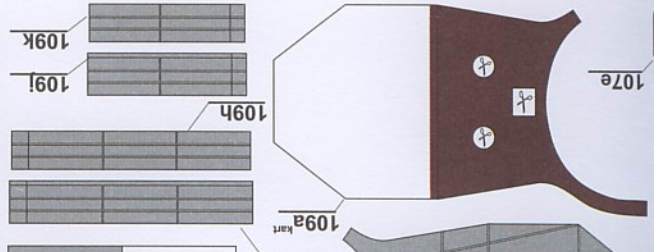
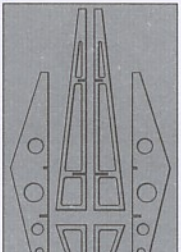
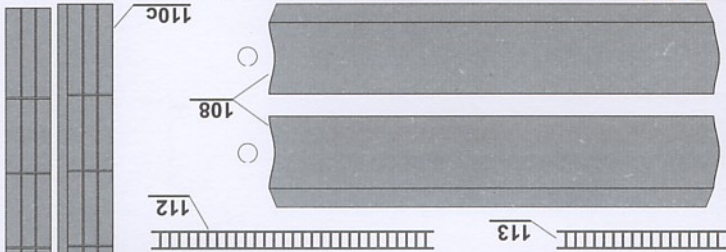

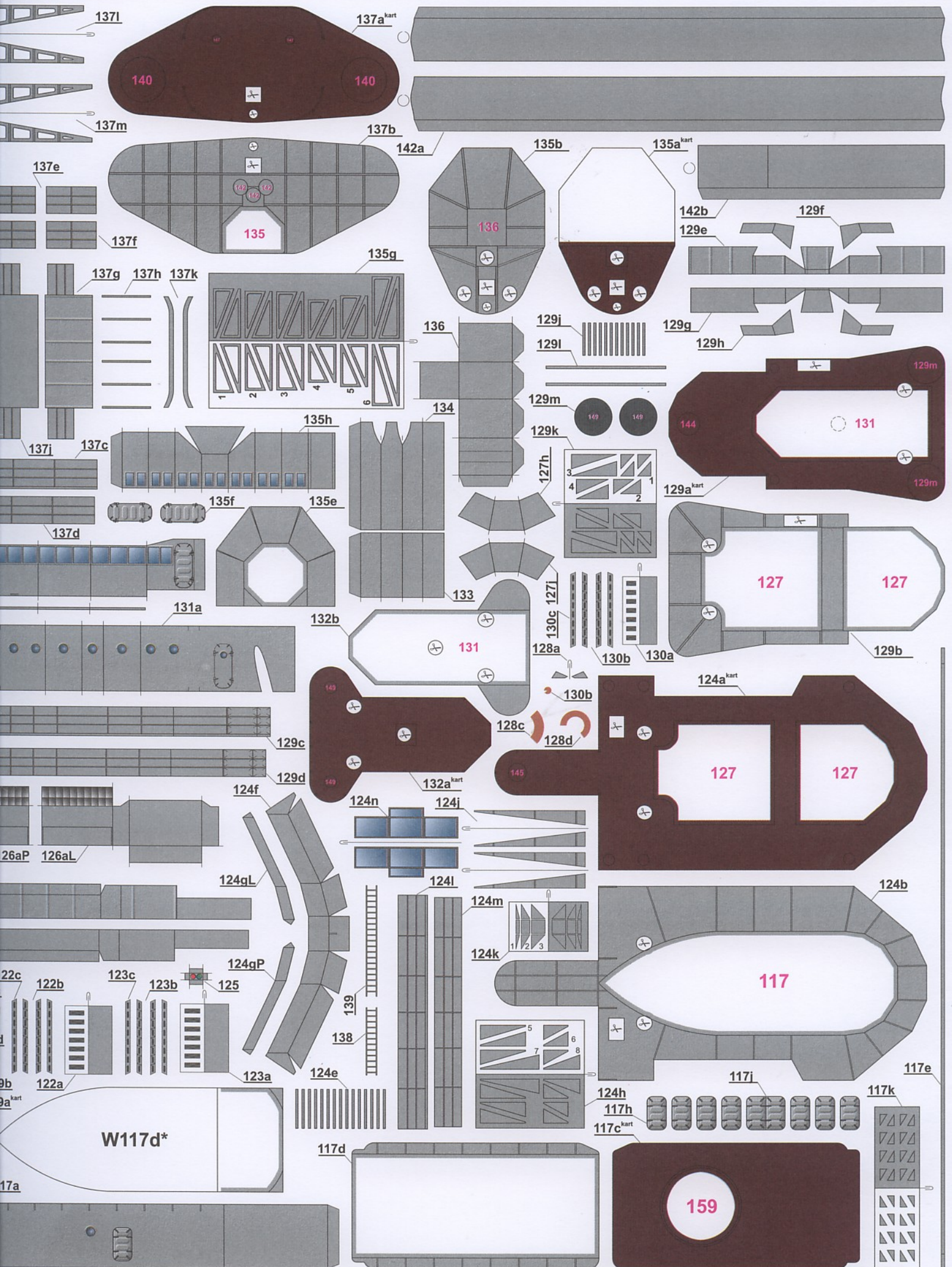

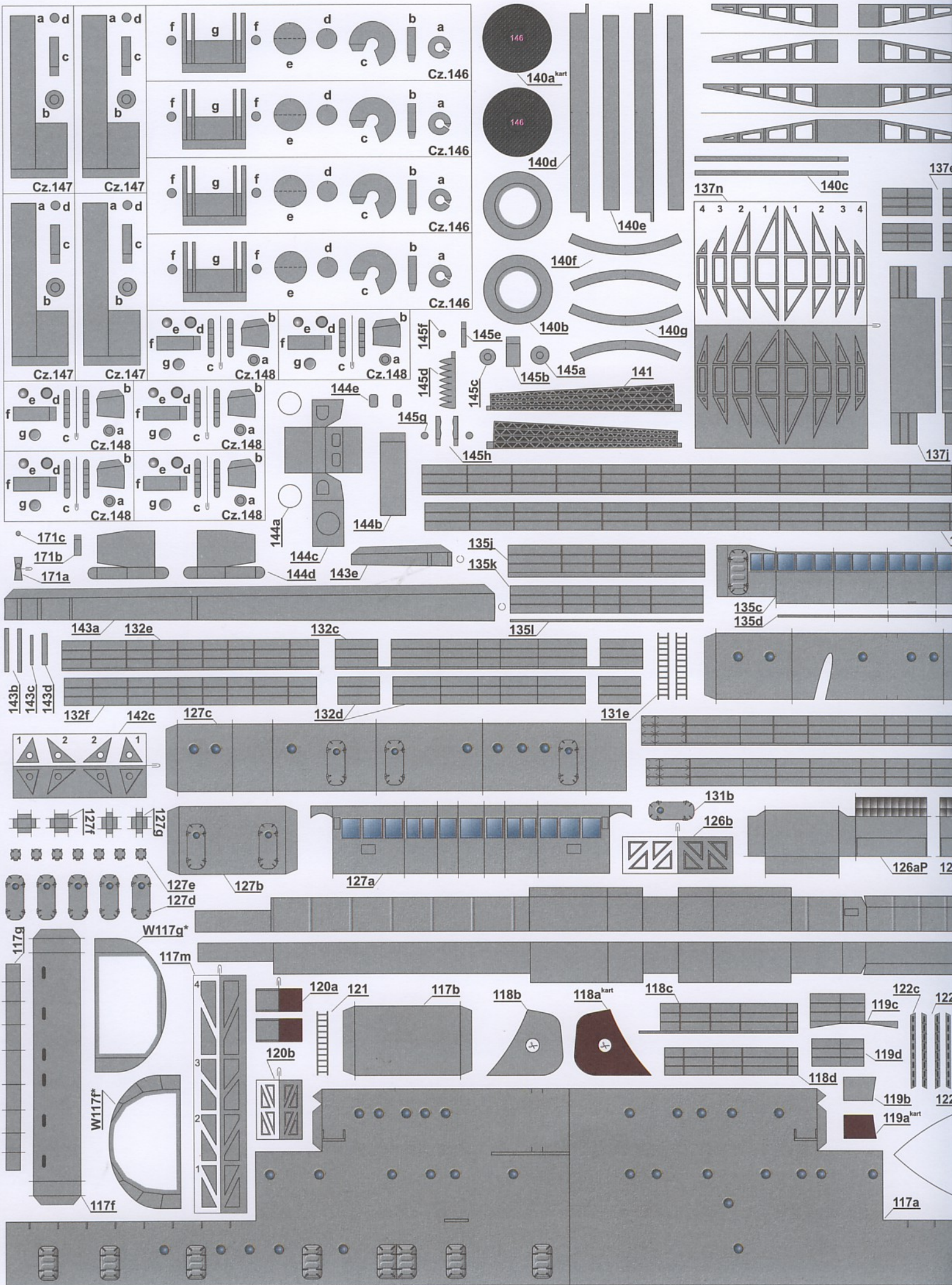



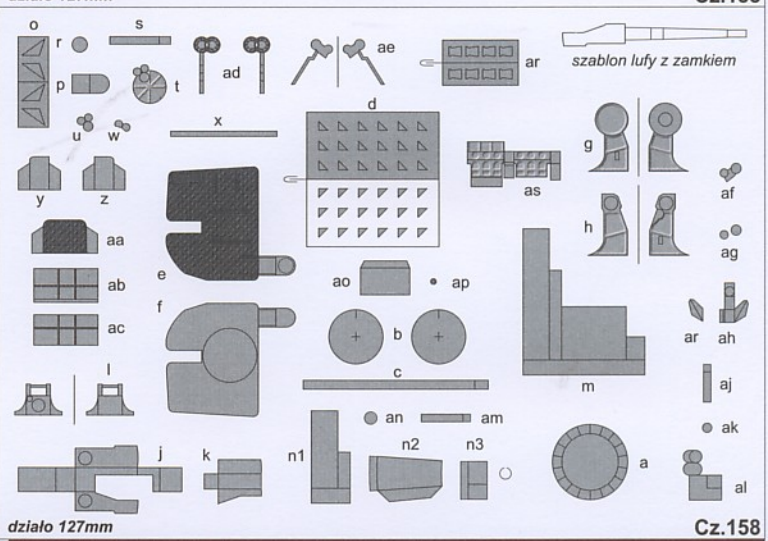
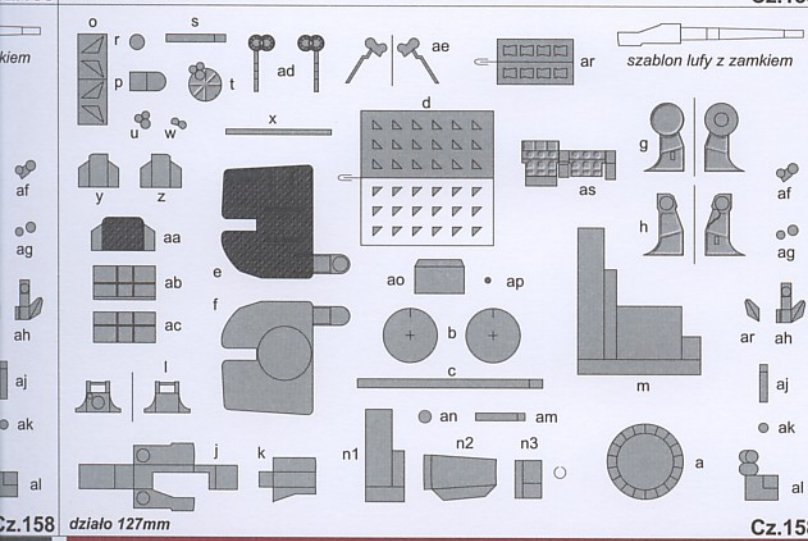
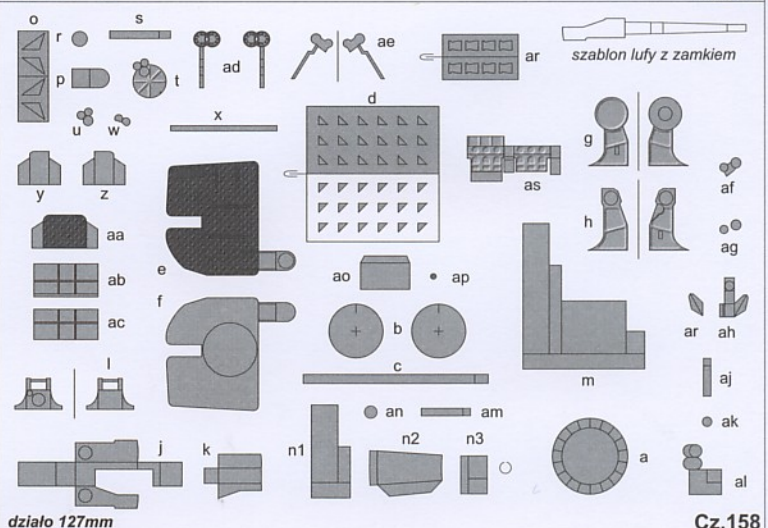
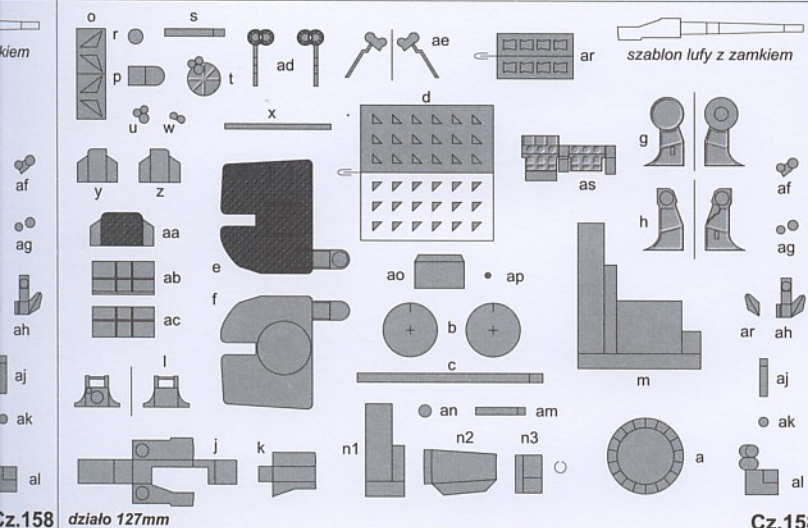
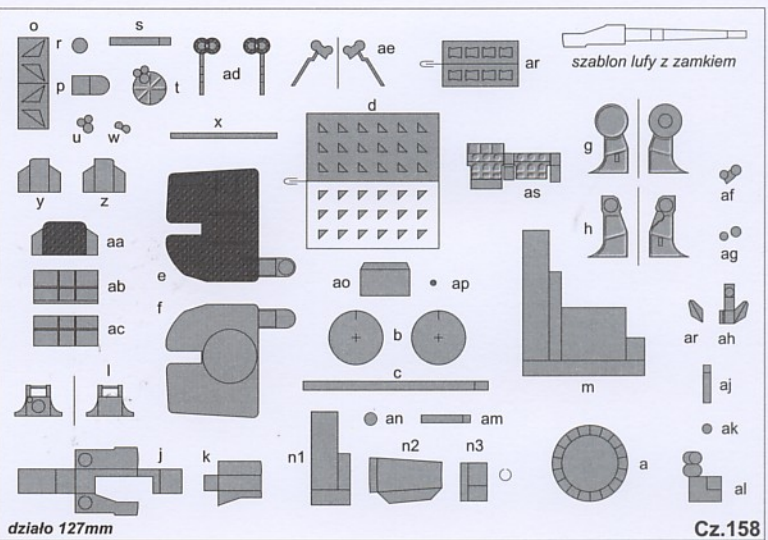
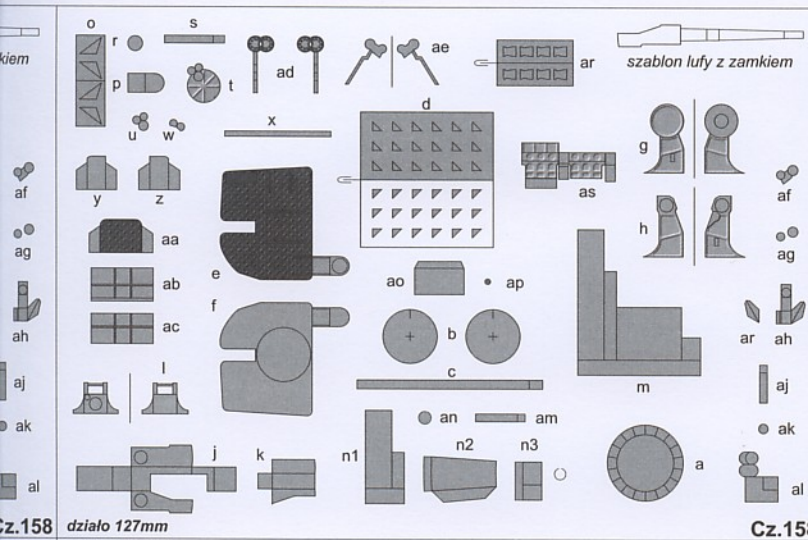

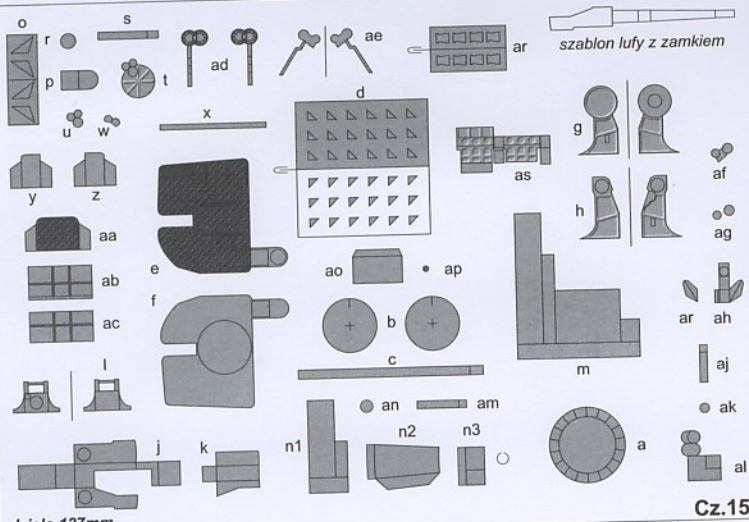

działo 127mm

Cz.158

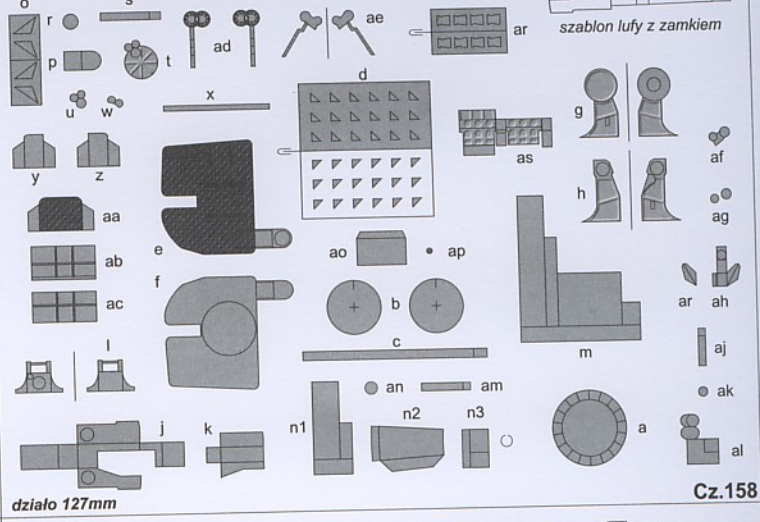

działo 127mm

Cz.158

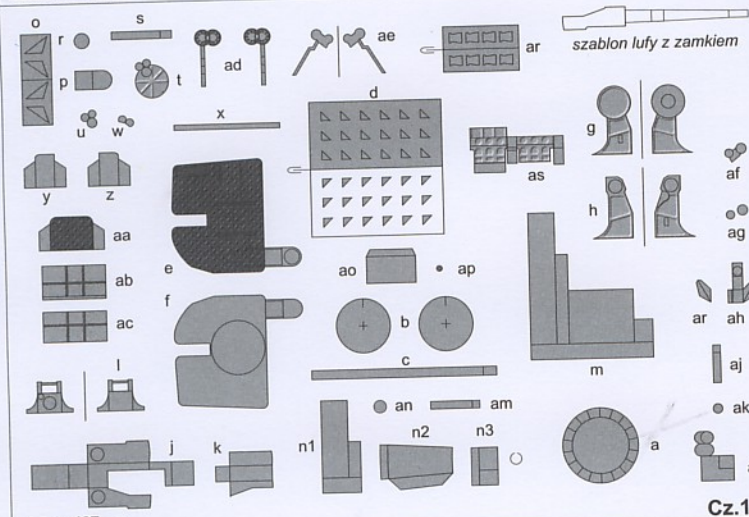

działo 127mm

Cz.158

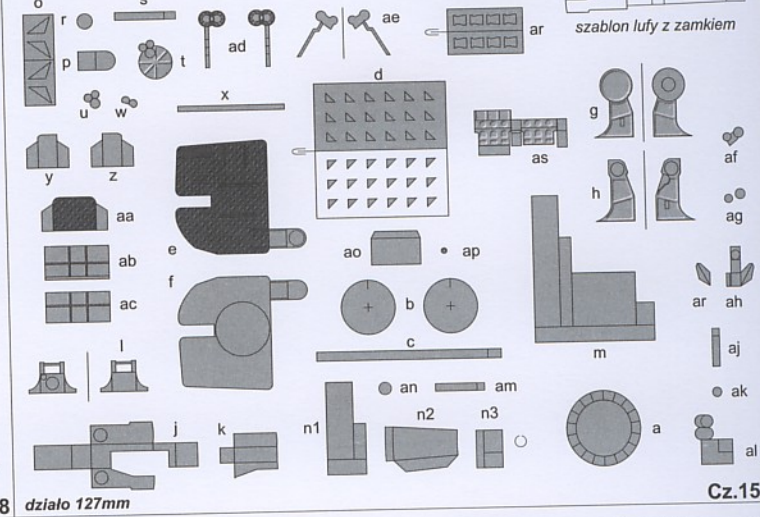

działo 127mm

Cz.158

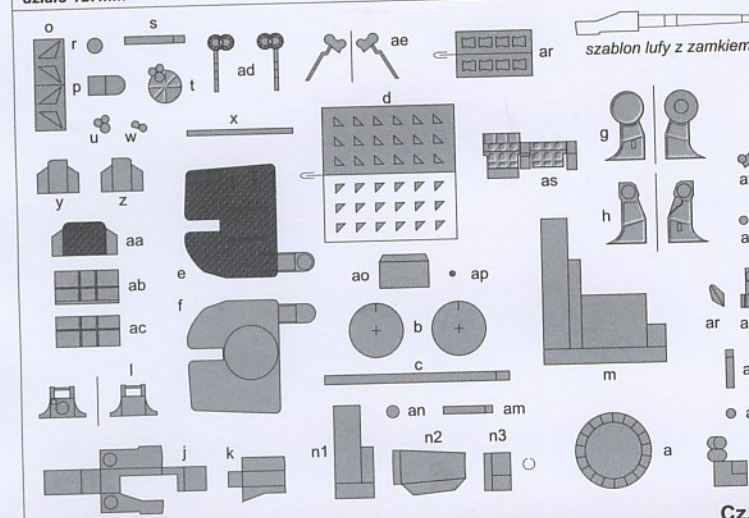

działo 127mm

Cz.158

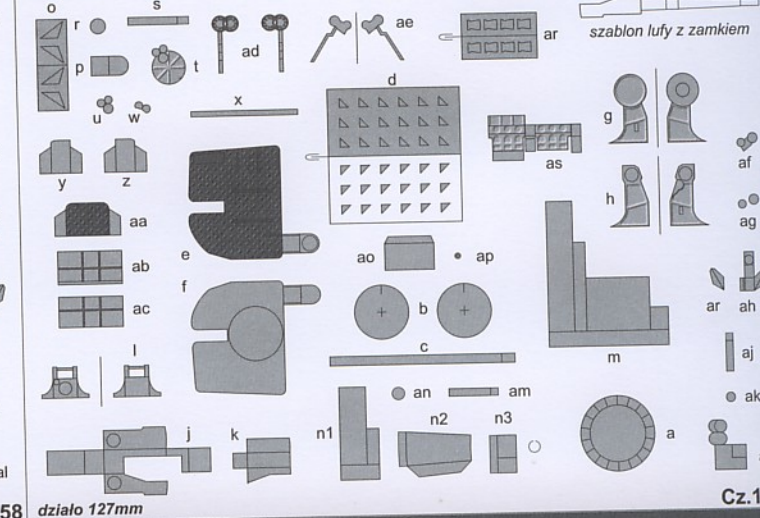

działo 127mm

Cz.158

Z.159

wieża art. gl. 203mm C

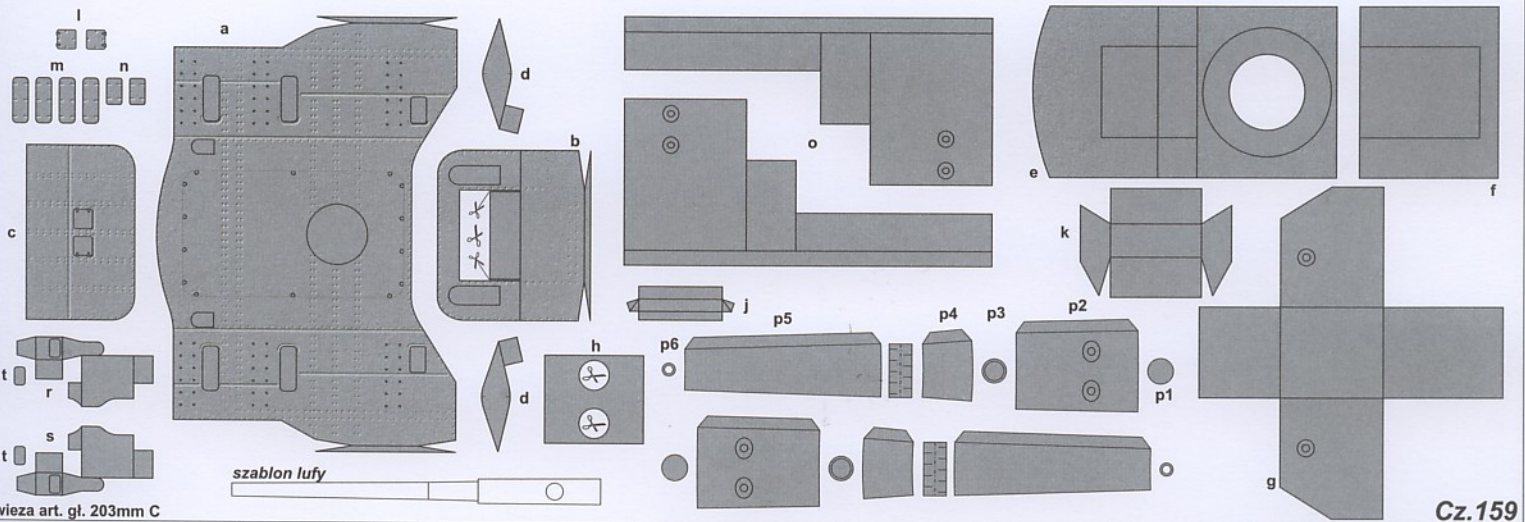

Cz.159

Z.159

wieża art. gl. 203mm D

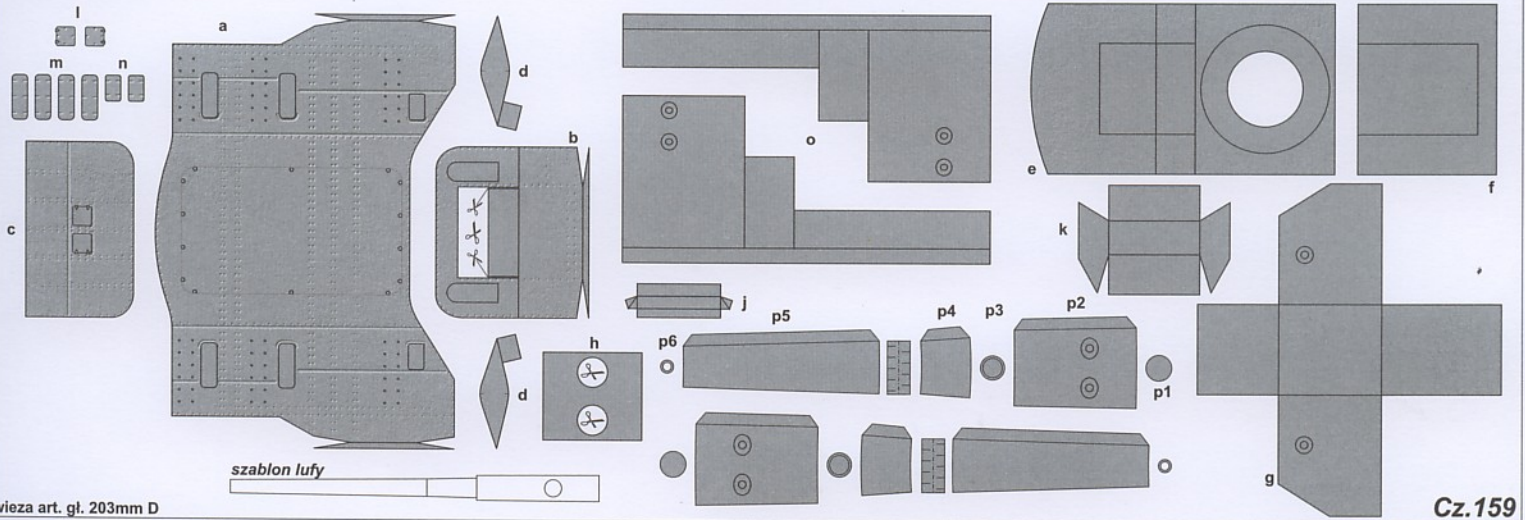

Cz.159

hP

hL

W7

y

SF-1

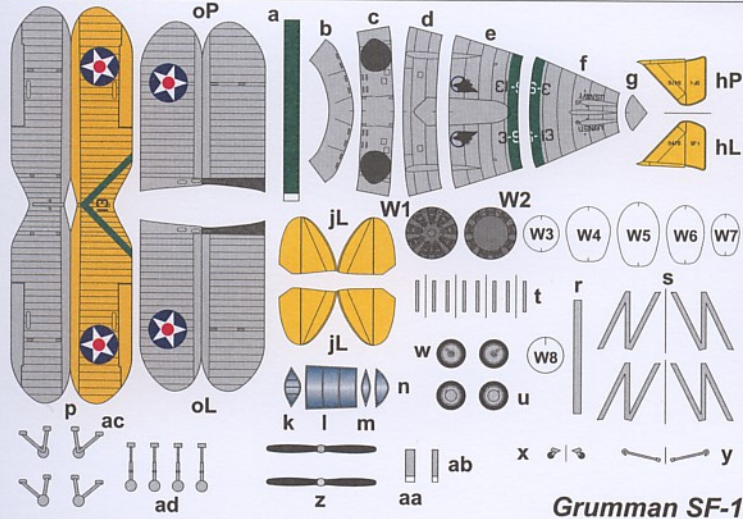

Grumman SF-1

hP

hL

W7

y

SF-1

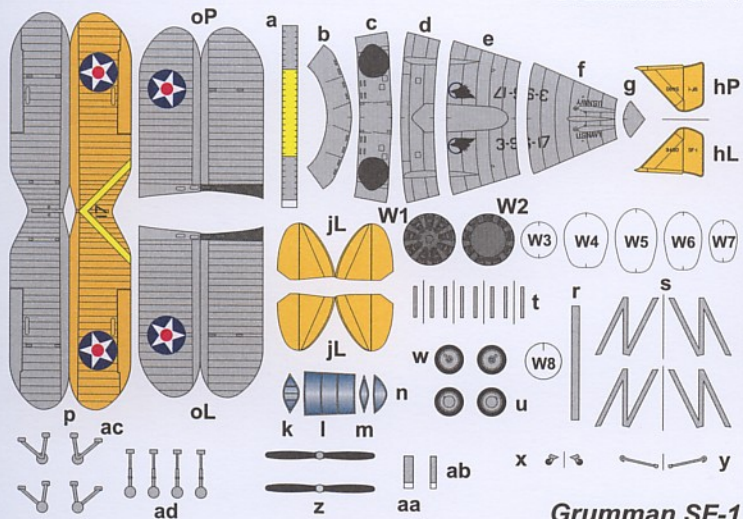

Grumman SF-1

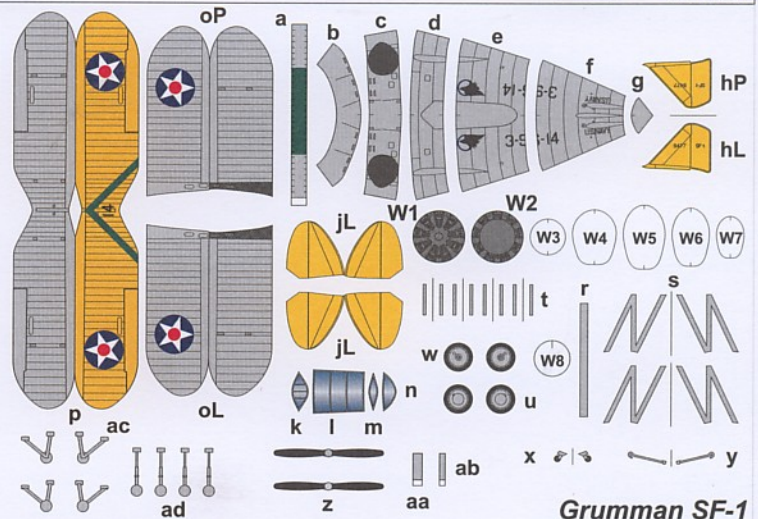

Grumman SF-1

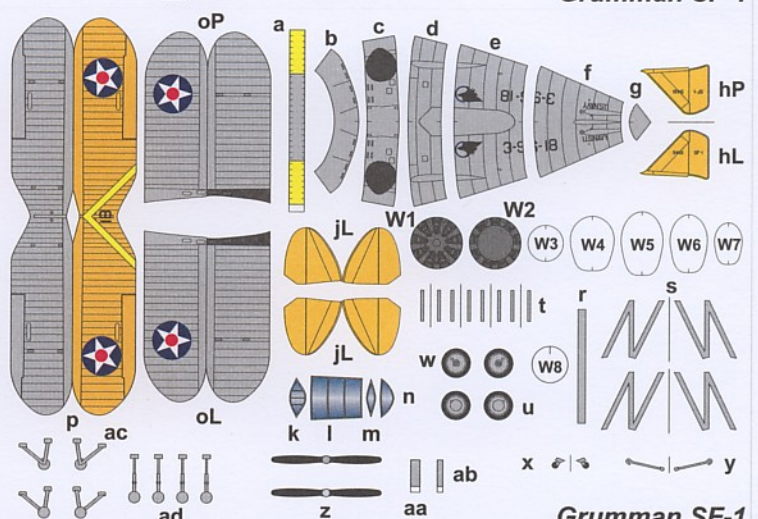

Grumman SF-1

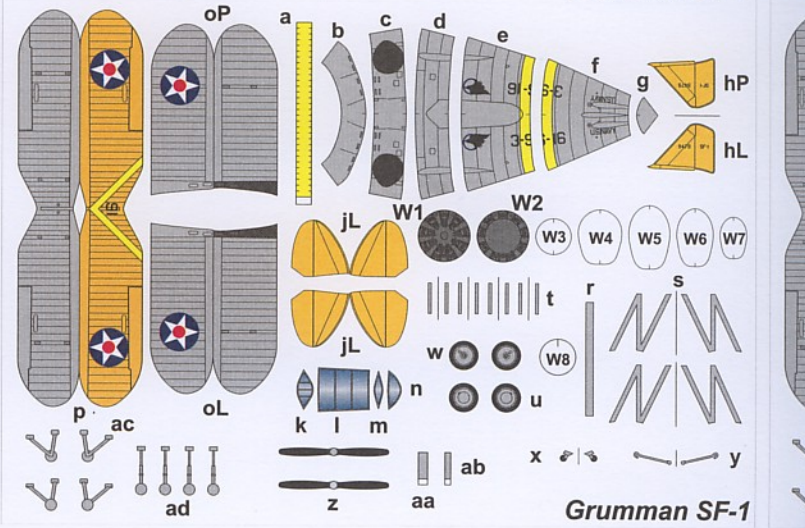
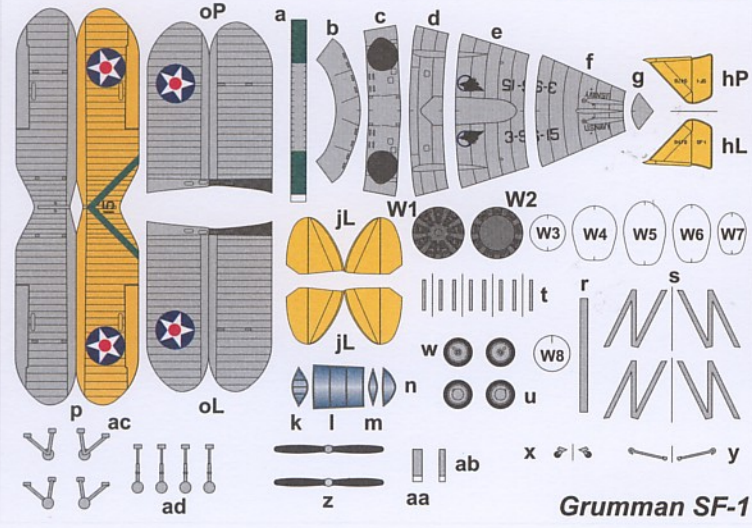
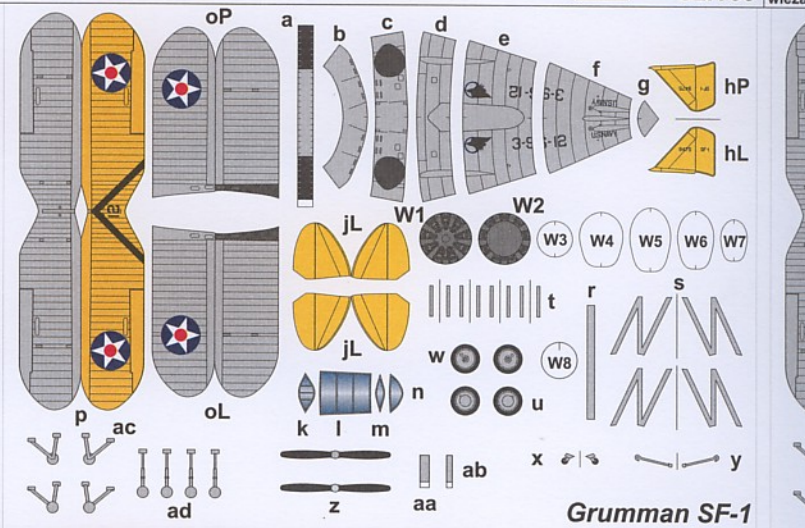
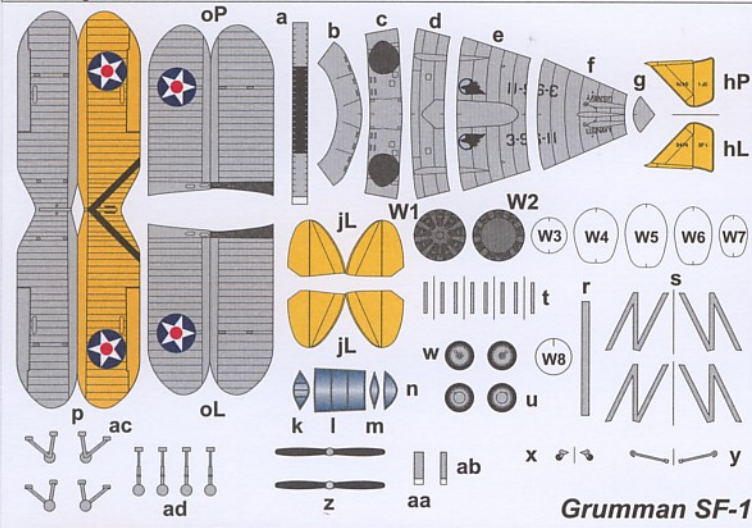
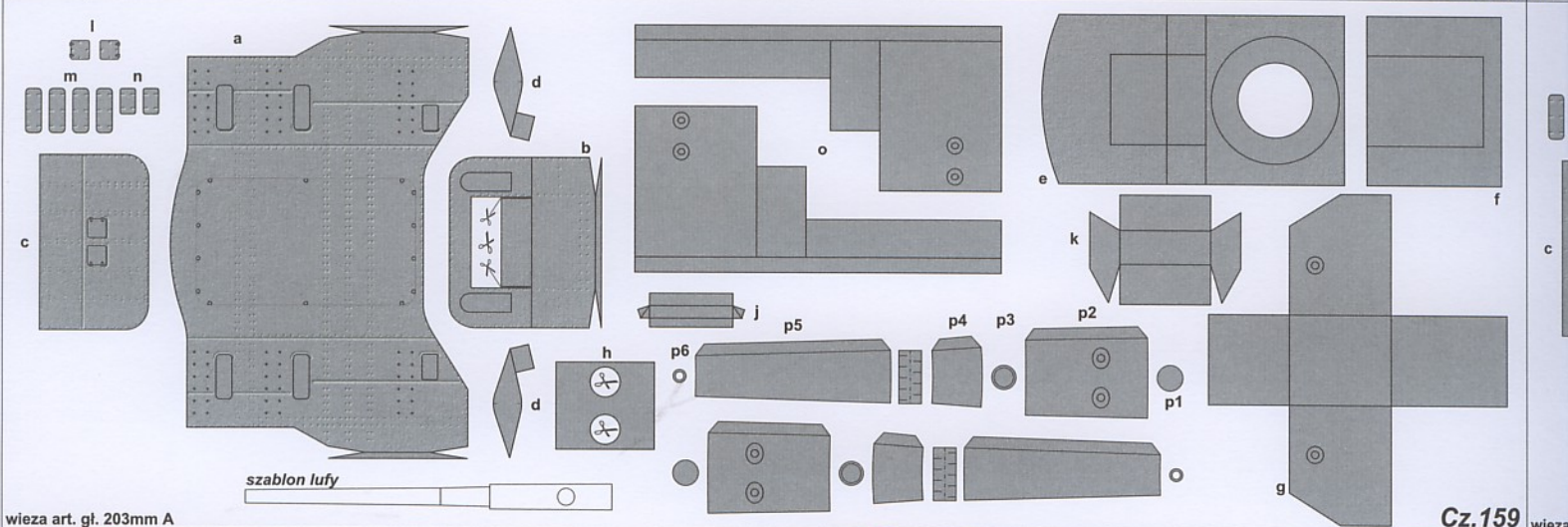
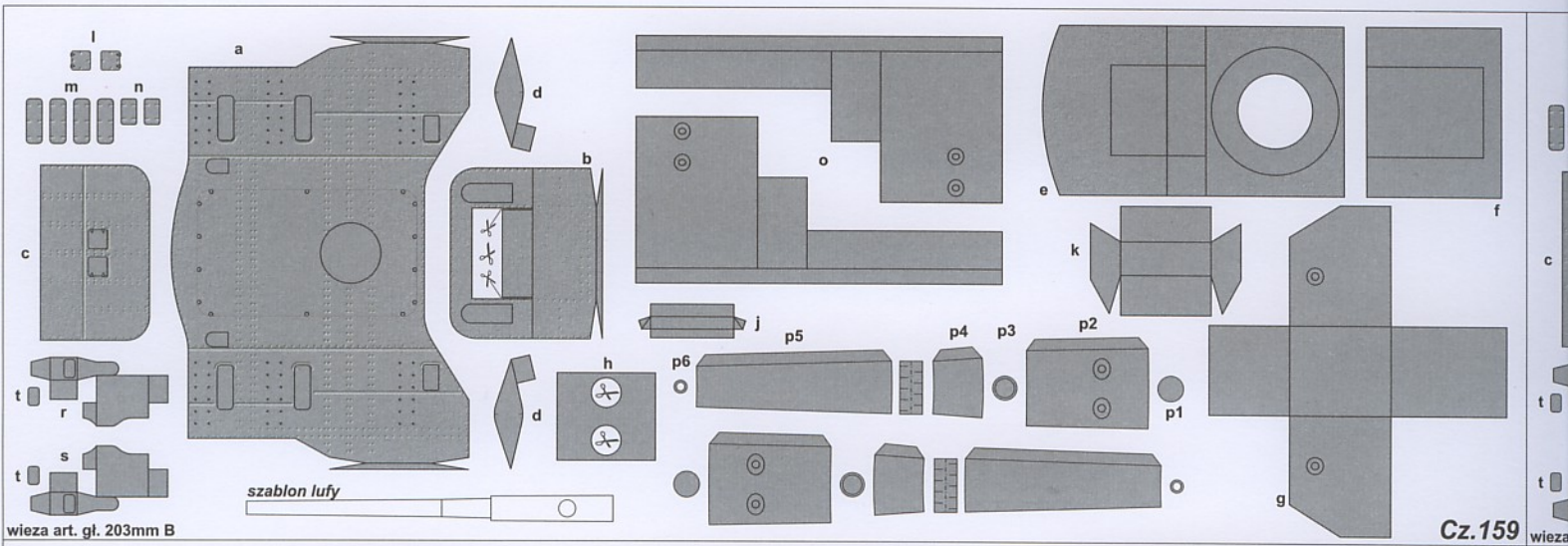



K2\*\*

K2\*\*

K3

K9\*

K10

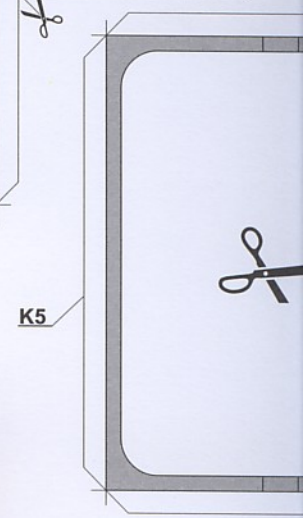
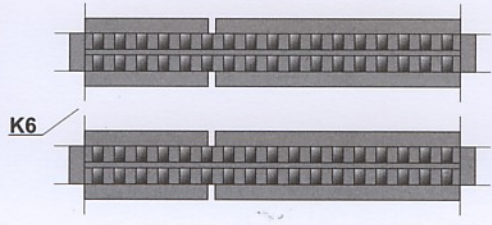
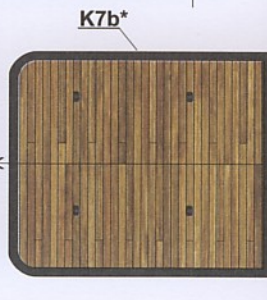
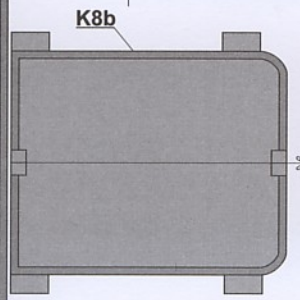
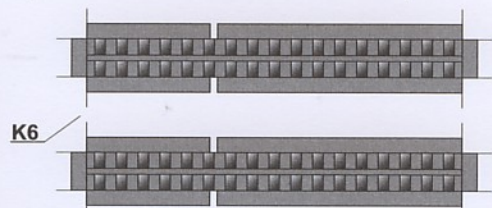
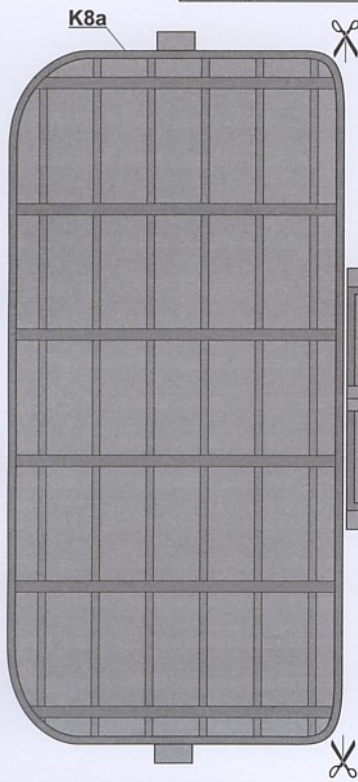
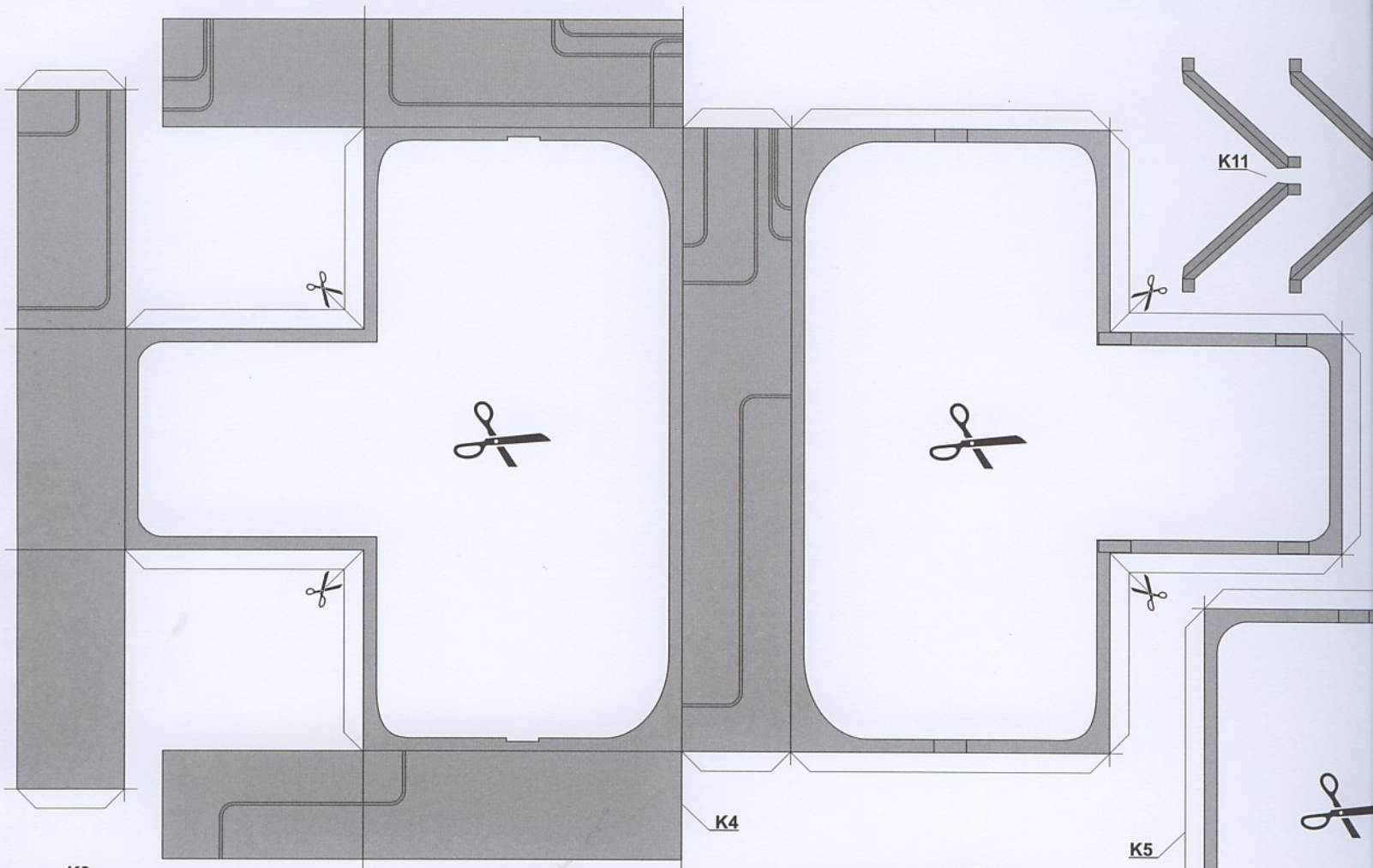

ZAPAS KOLORU



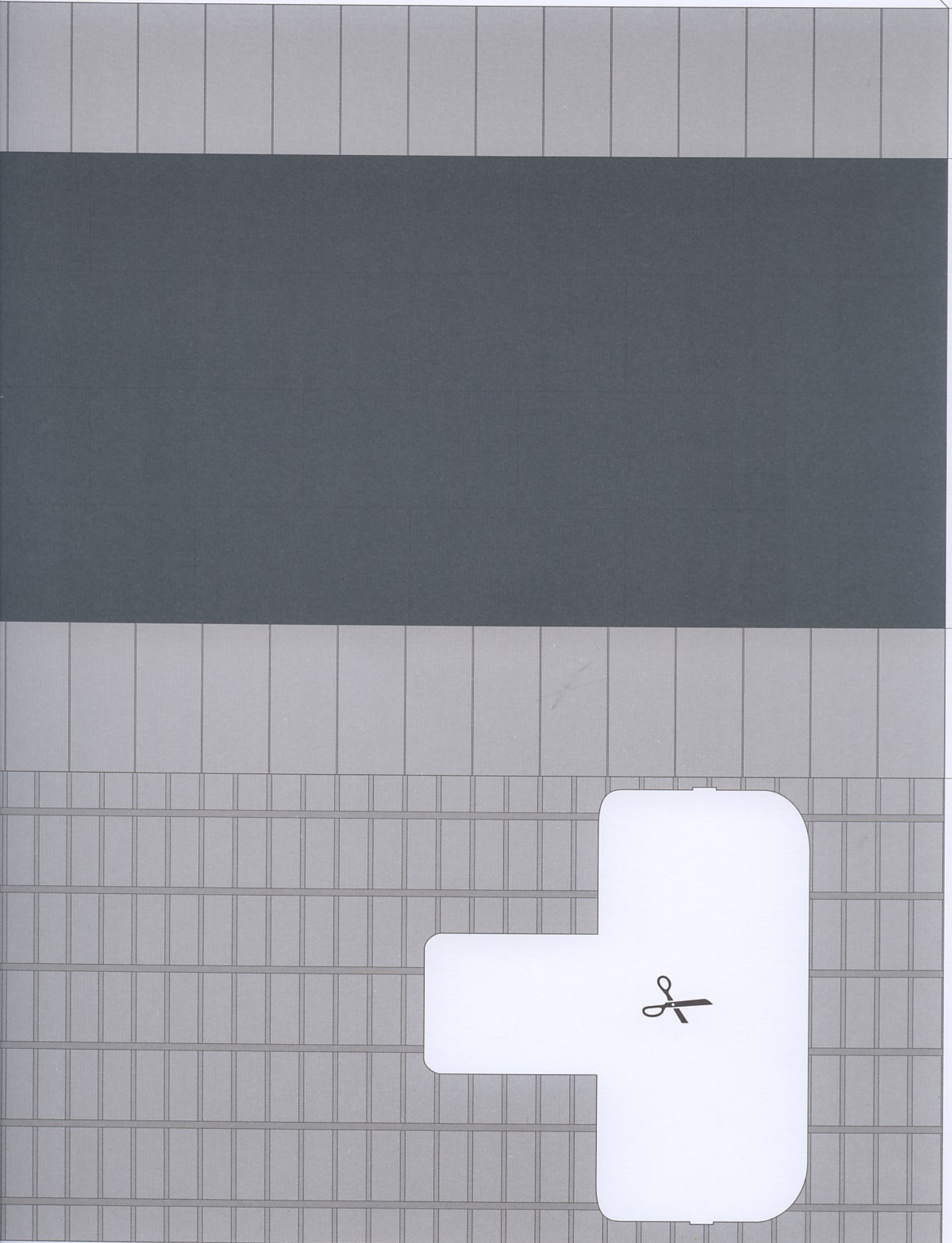

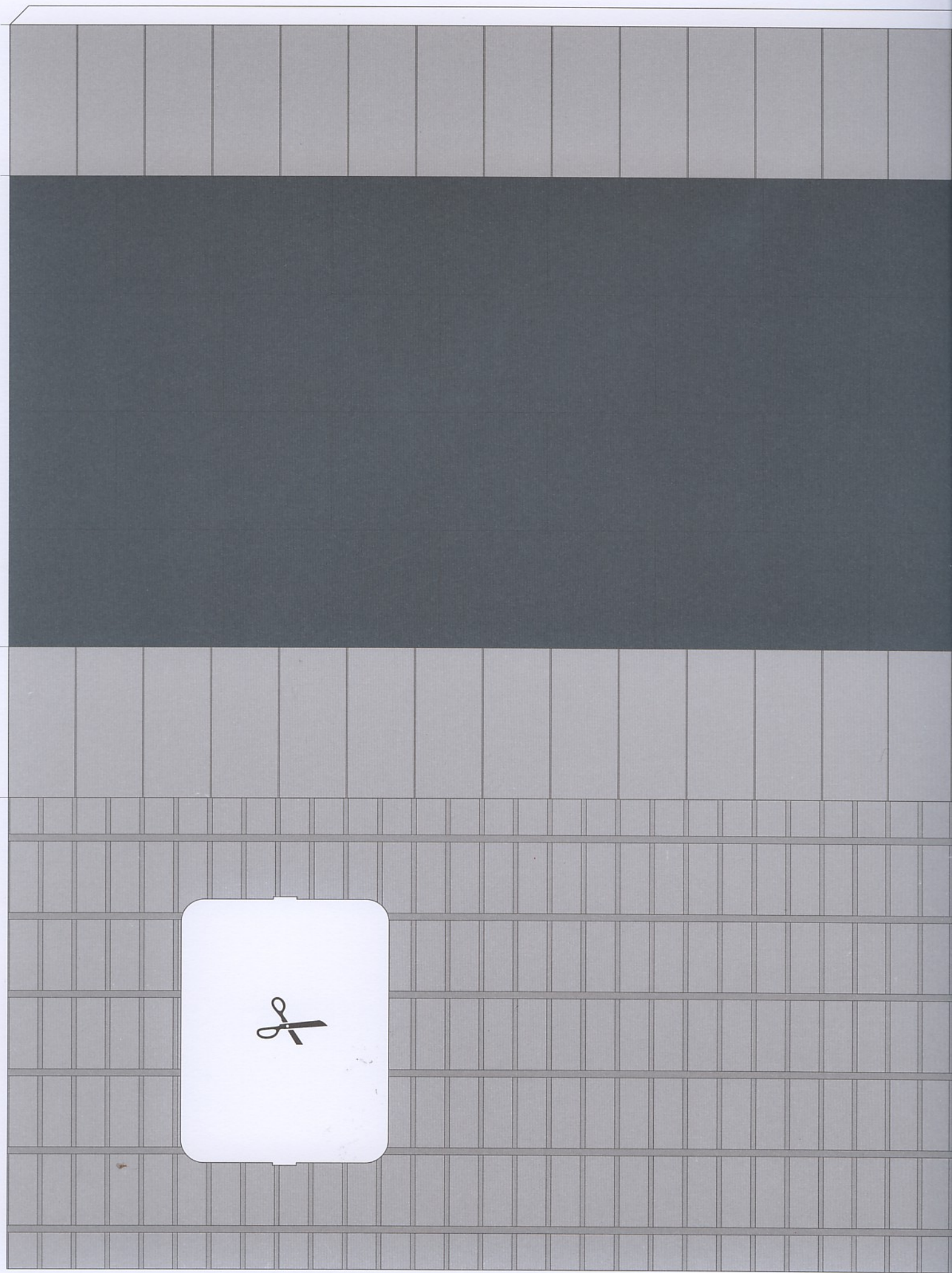



2F-1

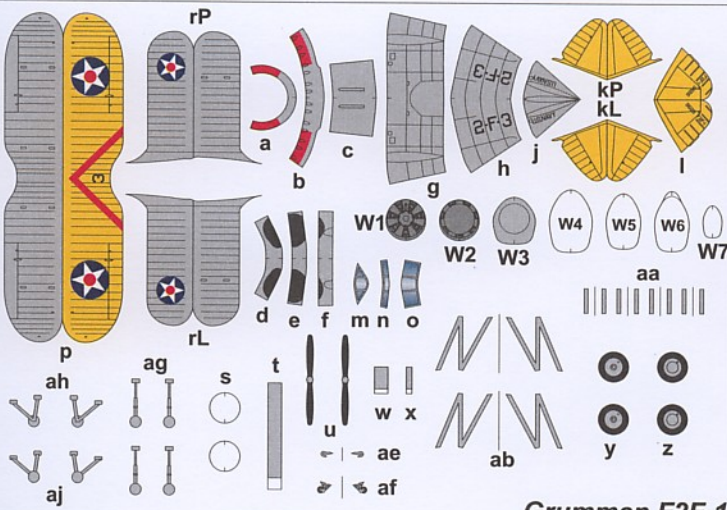

Grumman F2F-1

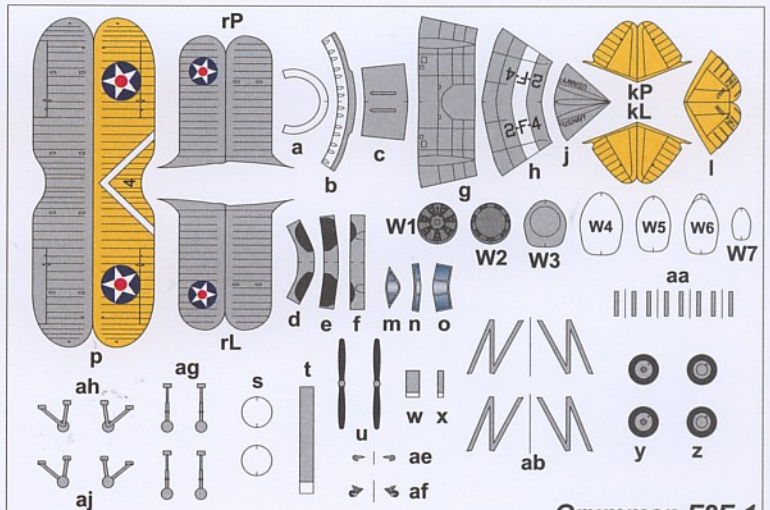

Grumman F2F-1

2F-1

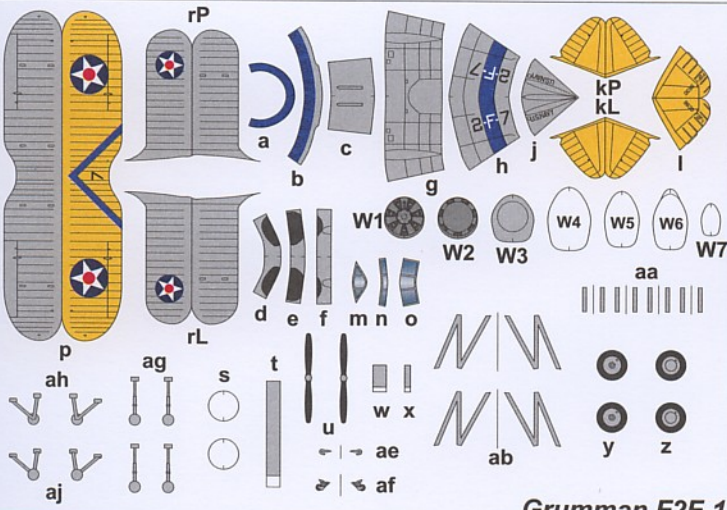

Grumman F2F-1

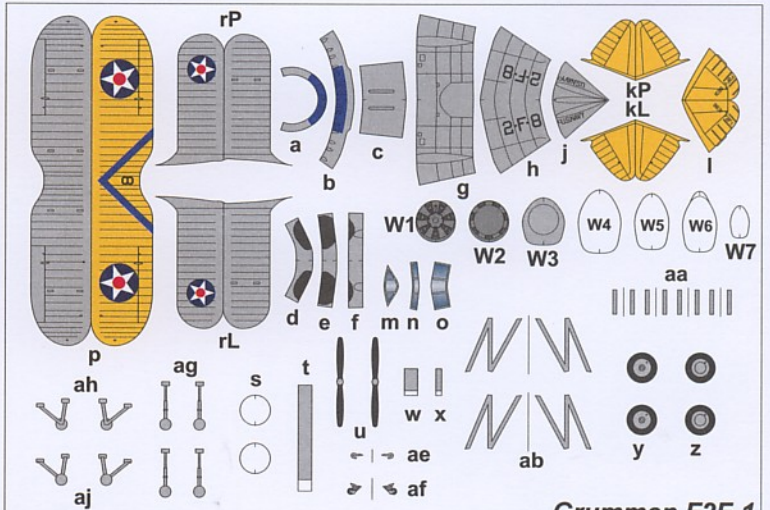

Grumman F2F-1

2F-1

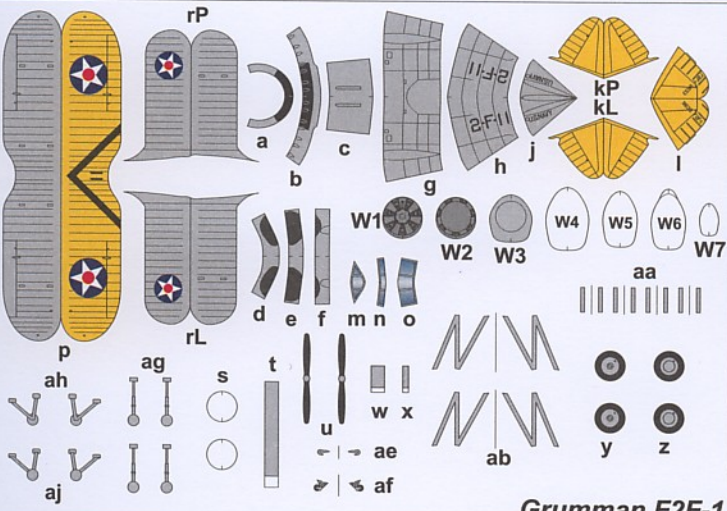

Grumman F2F-1

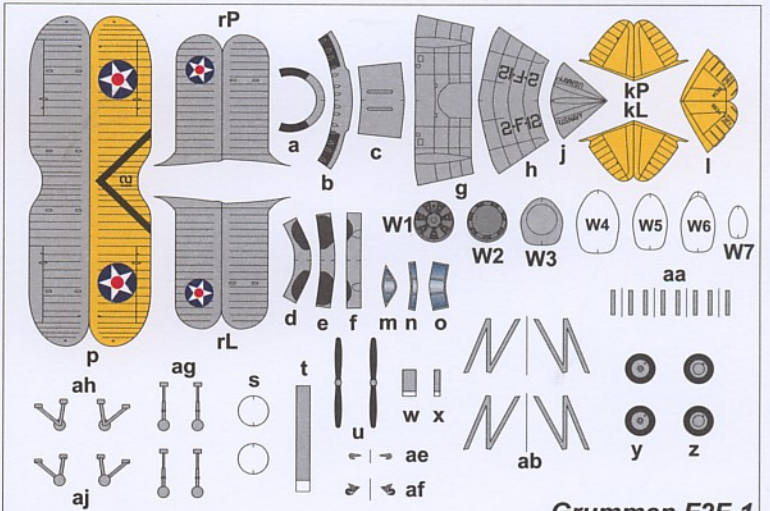

Grumman F2F-1

2F-1

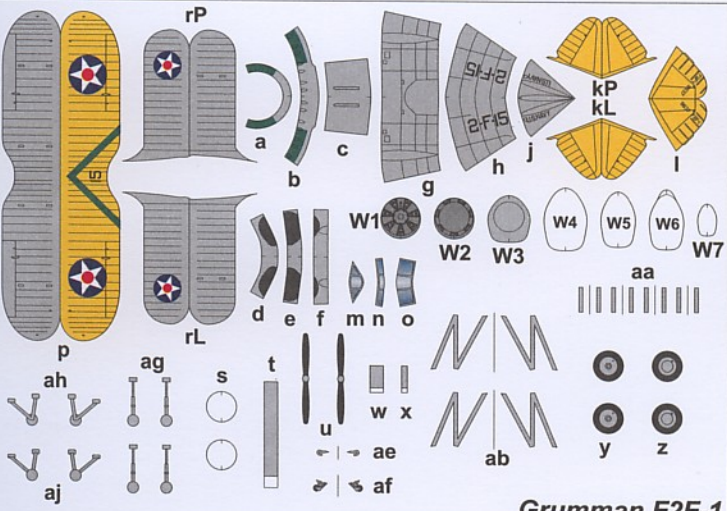

Grumman F2F-1

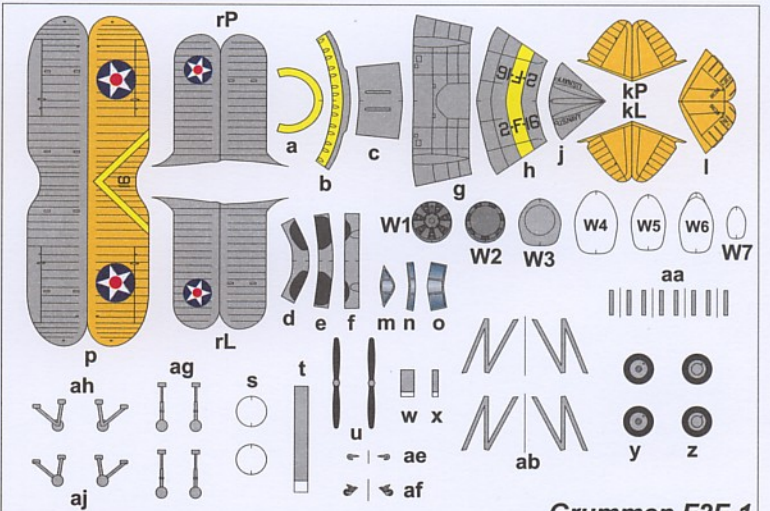

Grumman F2F-1

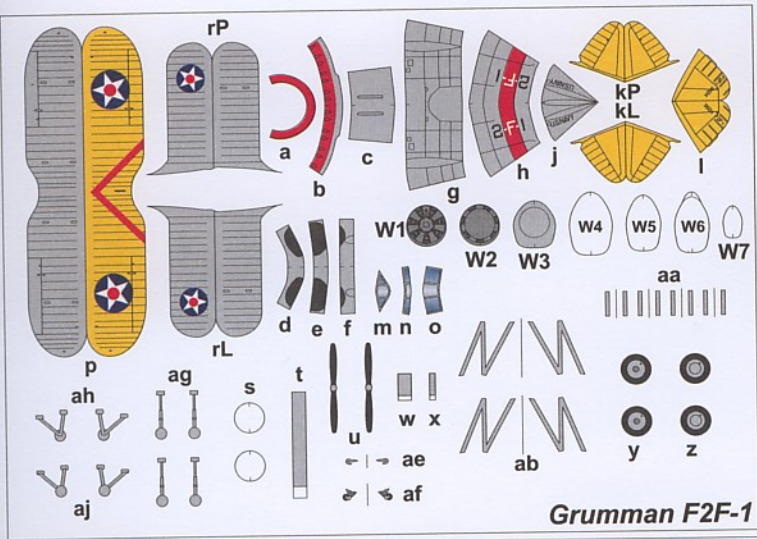

**Grumman F2F-1**

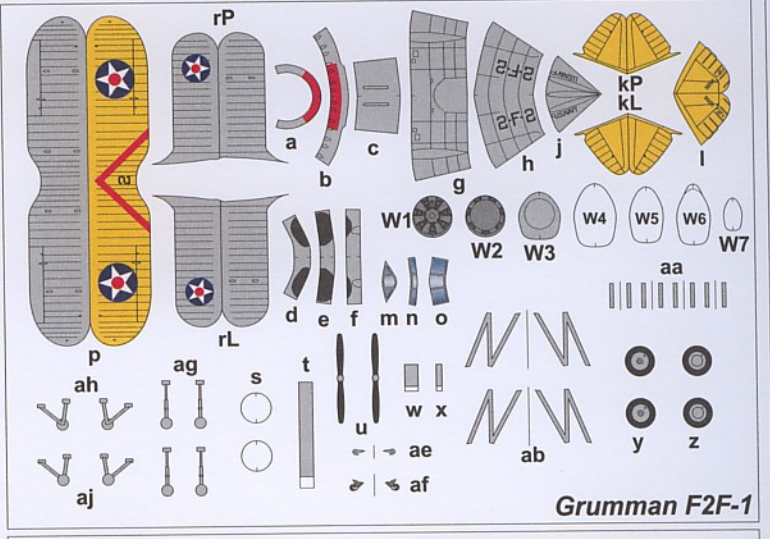

**Grumman F2F-1**

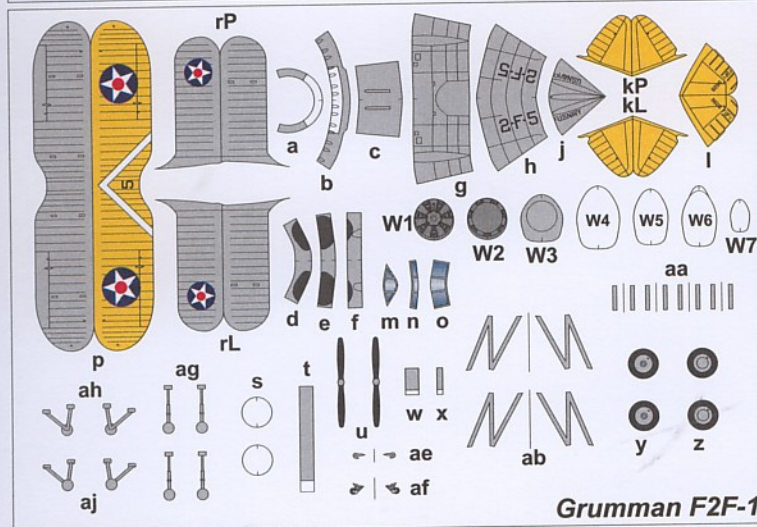

**Grumman F2F-1**

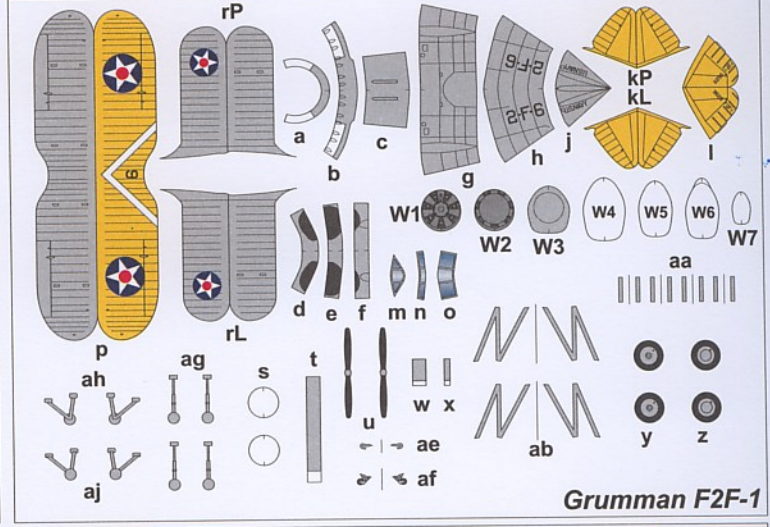

**Grumman F2F-1**

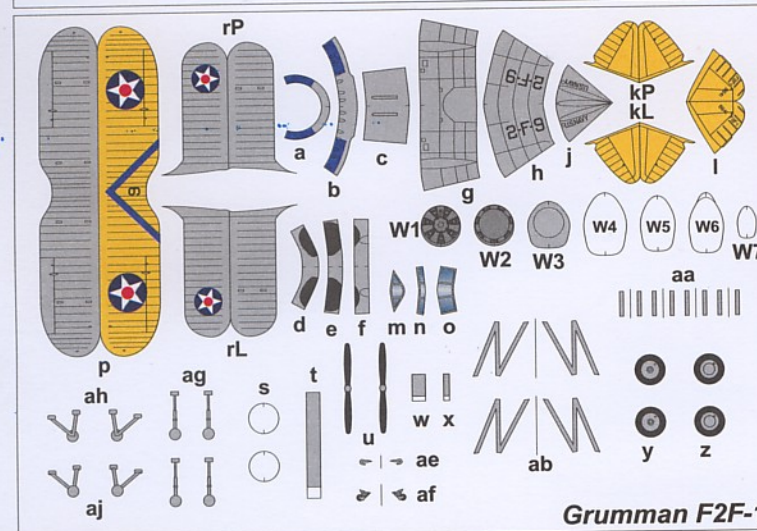

**Grumman F2F-1**

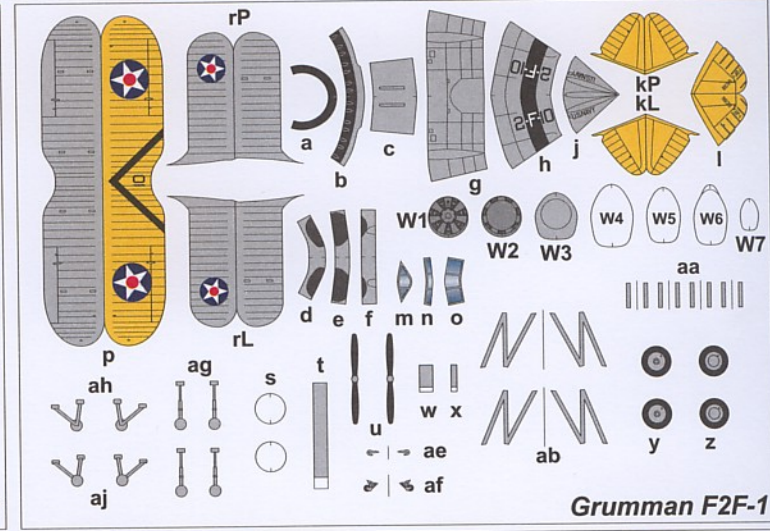

**Grumman F2F-1**

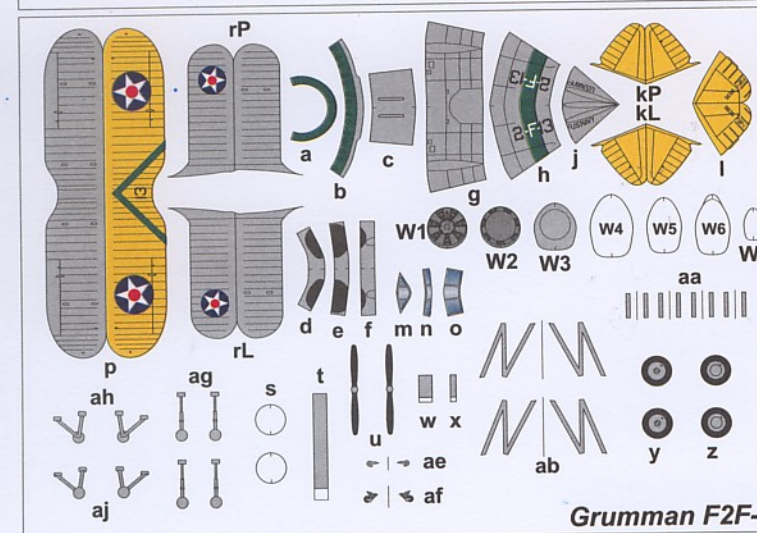

**Grumman F2F-1**

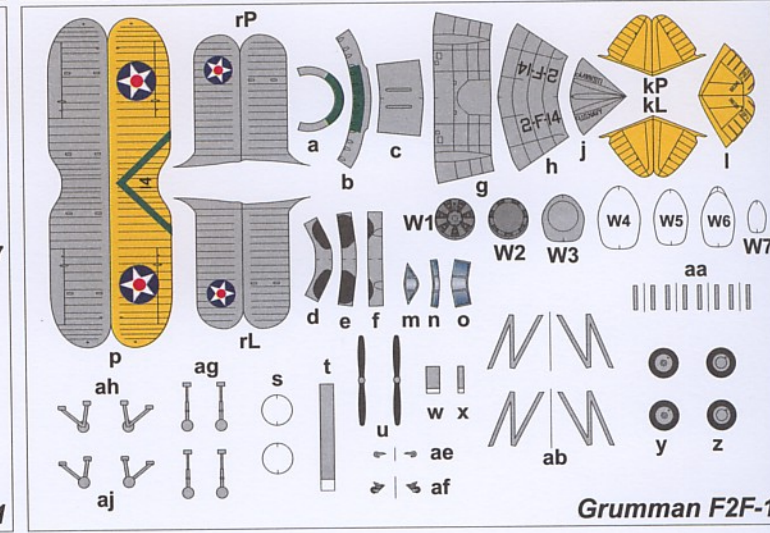

**Grumman F2F-1**

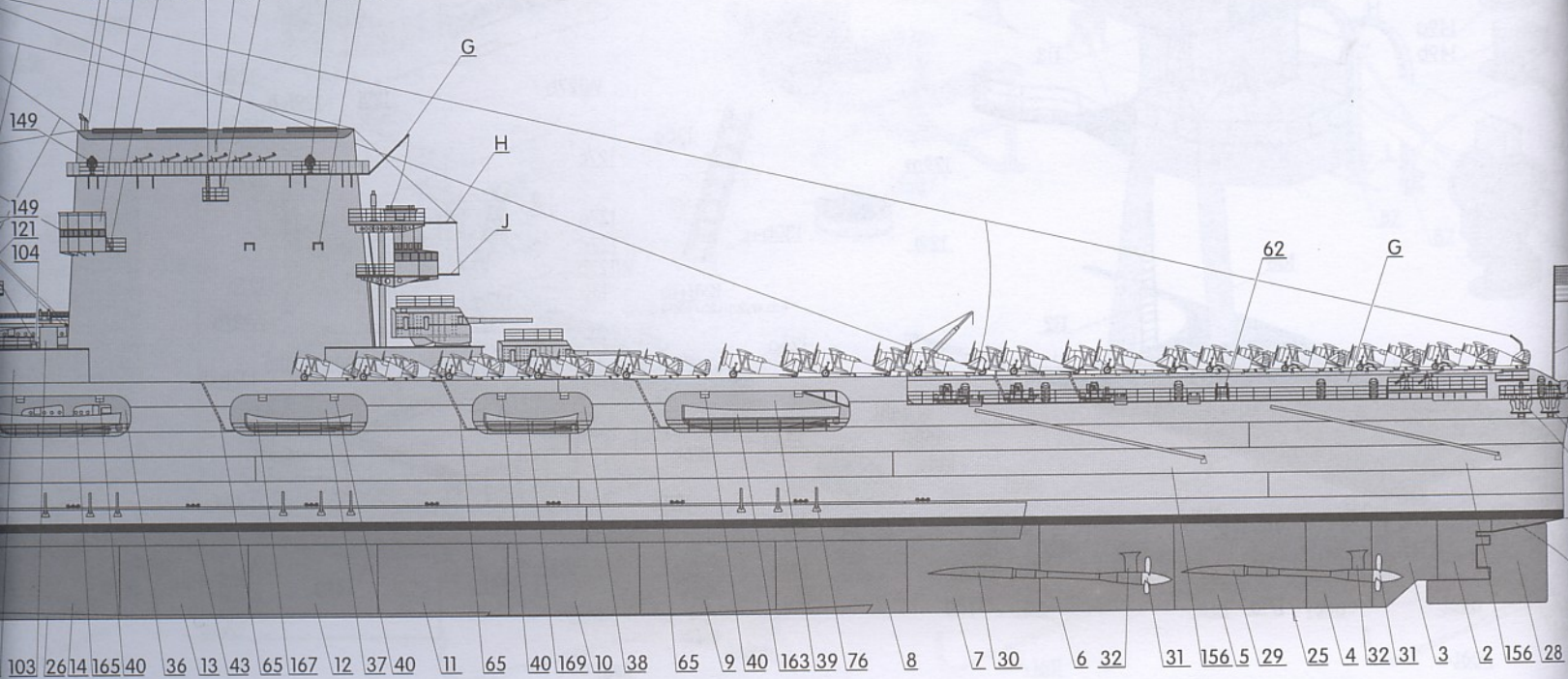
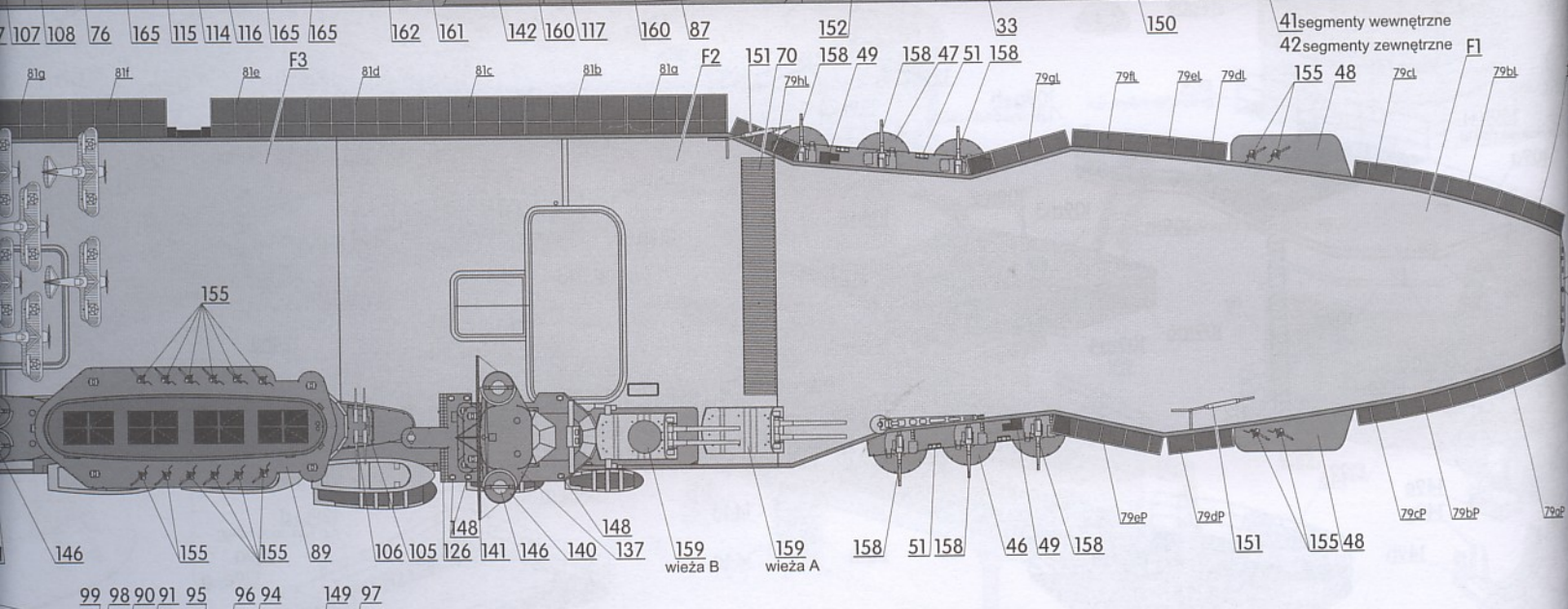
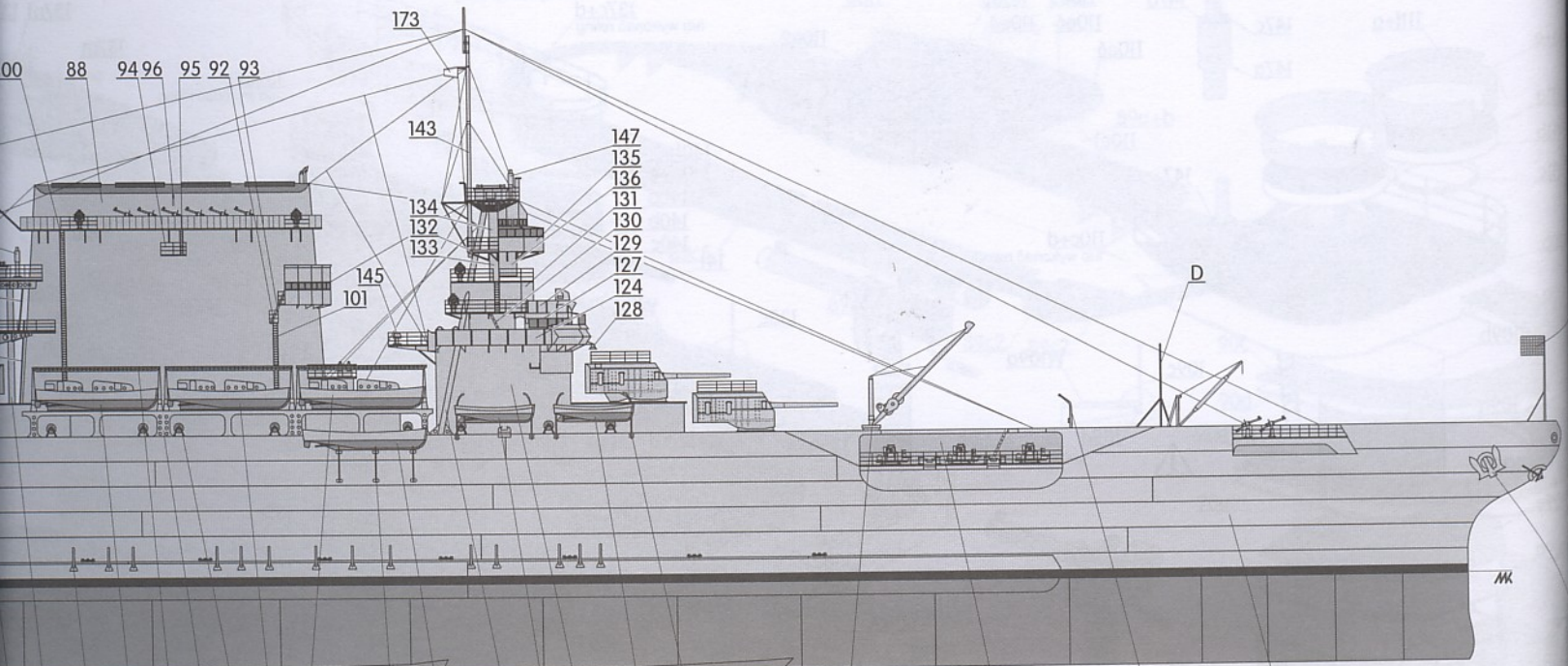

# USS LEXINGTON (CV-2)

