

KARTONOWE  
**ABC** 9'2001  
ISSN 1428 - 4618

# BISMARCK

# GPM

<http://www.gpm.pl>

NR KAT. **182**

SERIA "J"

STOPNIEC  
TRUDNOŚĆ

1

2

3

WYMIARY MODELU

DŁUGOŚĆ .....  
SZEROKOŚĆ .....  
WYSOKOŚĆ ..... cm

skala **1:200**

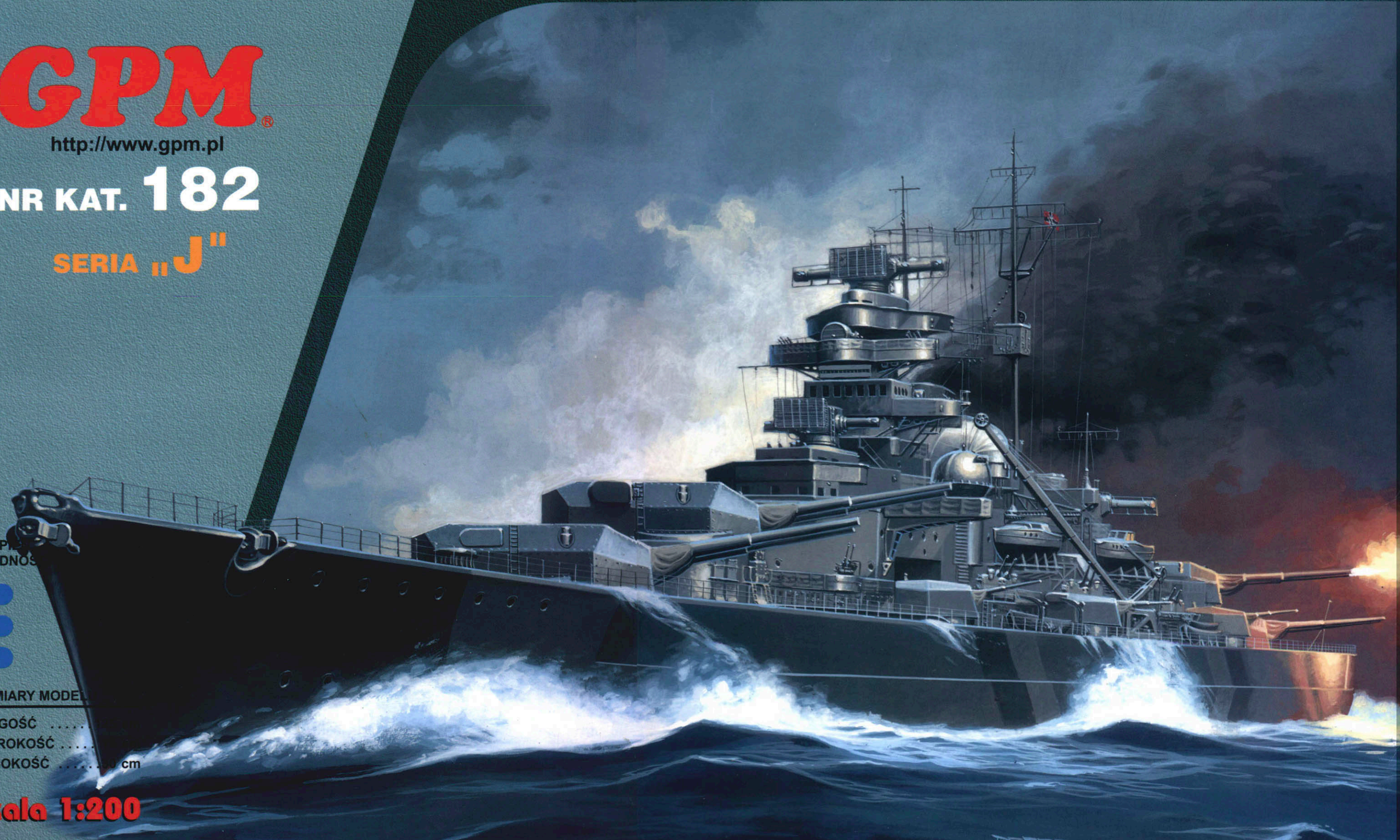

W81

W80\*

W82

W82\*

W89\*

W88\*

W31

W32\*

W30

W28

W75L

W76

W75P

W73\*

W82\* W81\*

W88\*

W87\* W88

W79\* W82 W80 W81

W29 W90\*

W77 W78 W74 W83\*

W85\* W86\*

W84\* W85 W86

W83\* W84 W85 W86

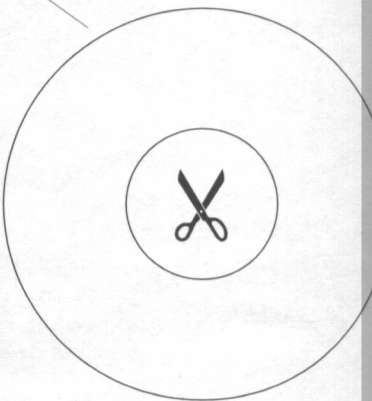
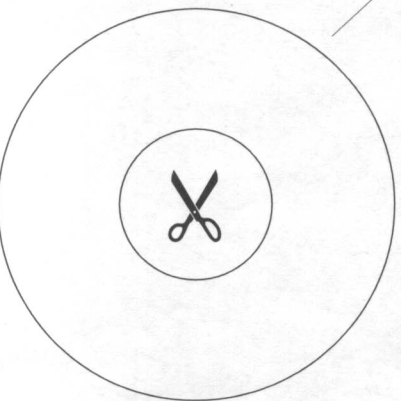
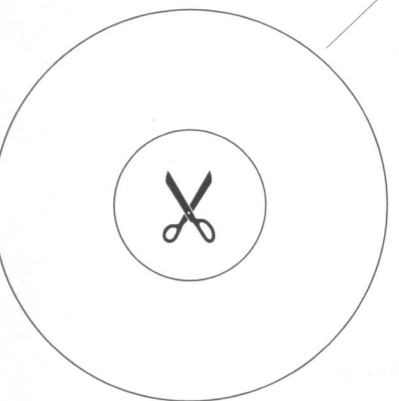
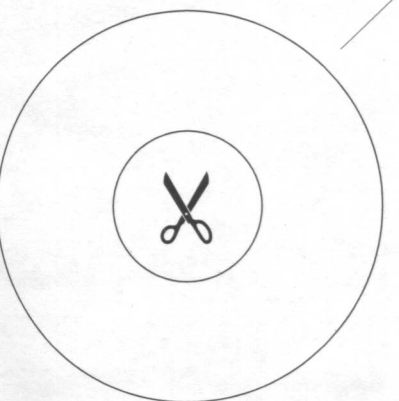
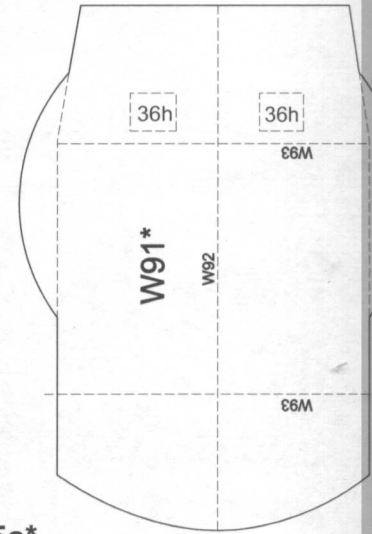
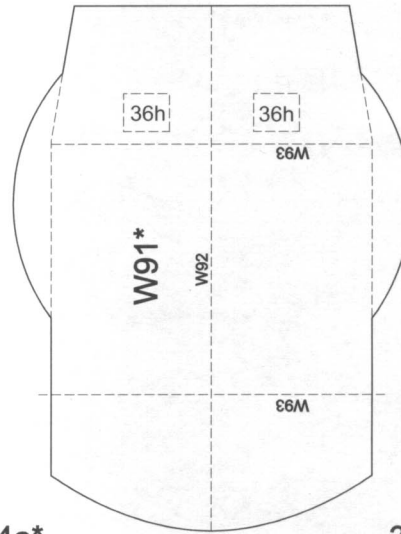
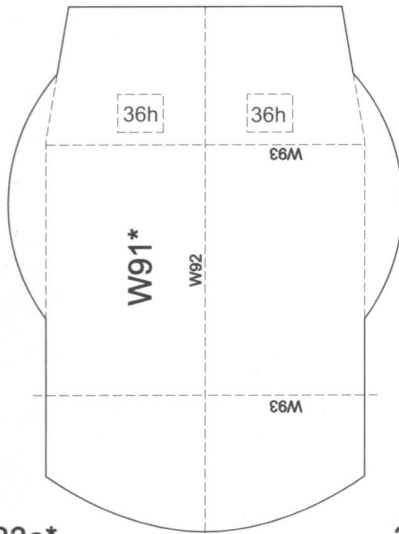
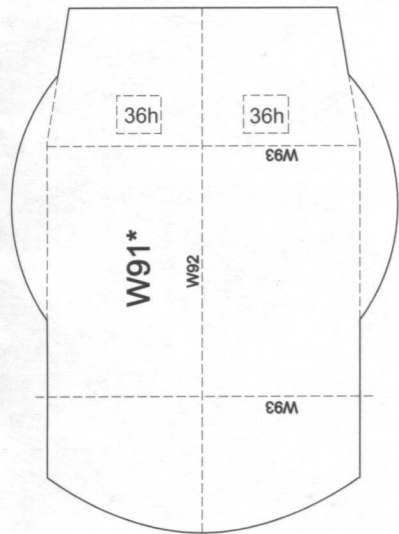
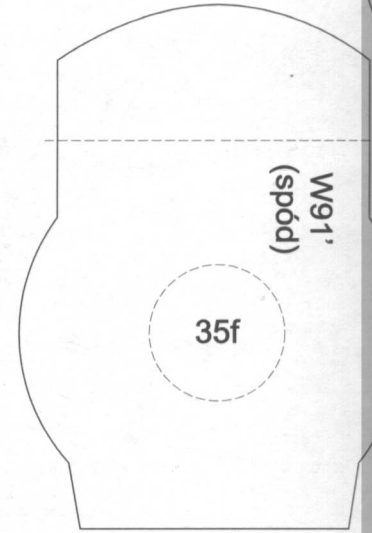
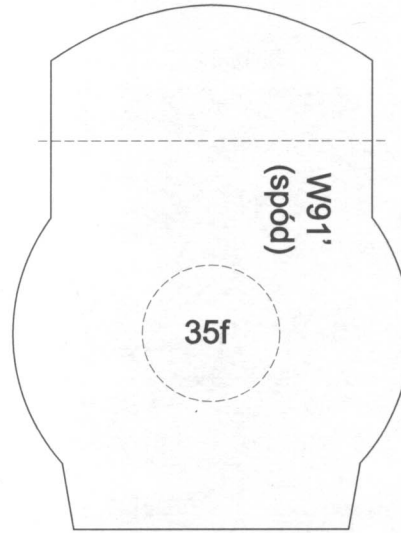
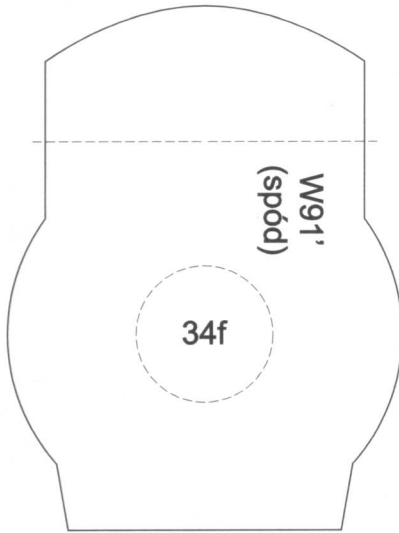
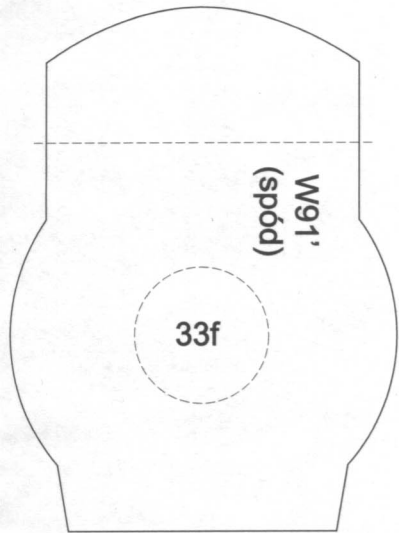
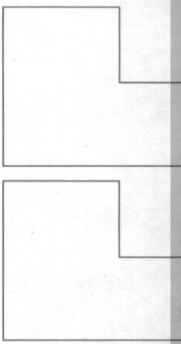
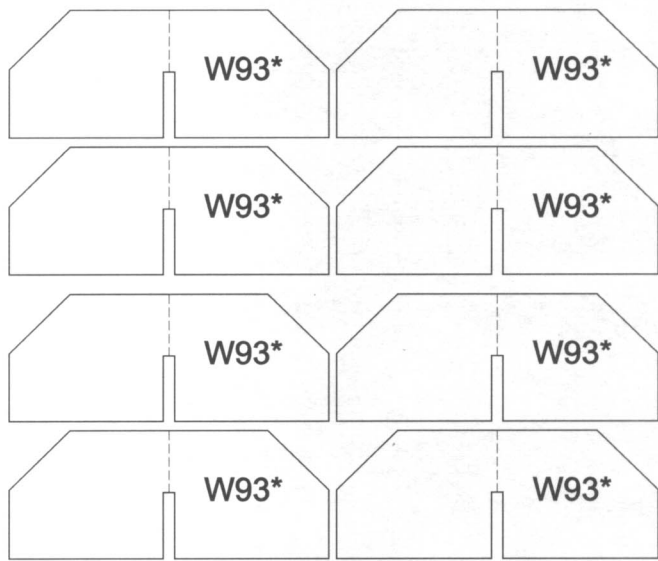
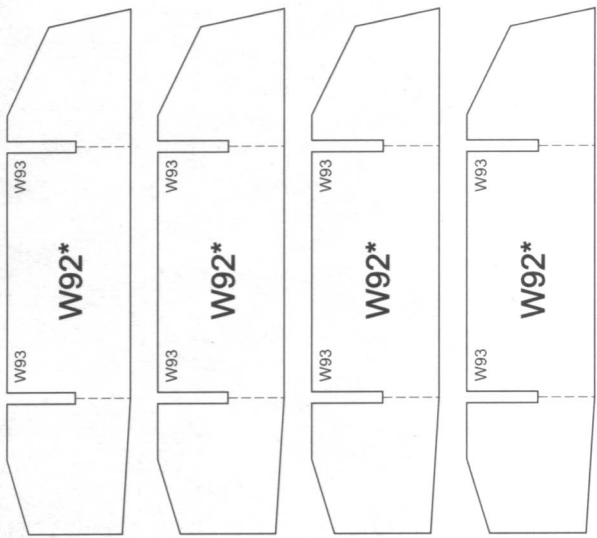



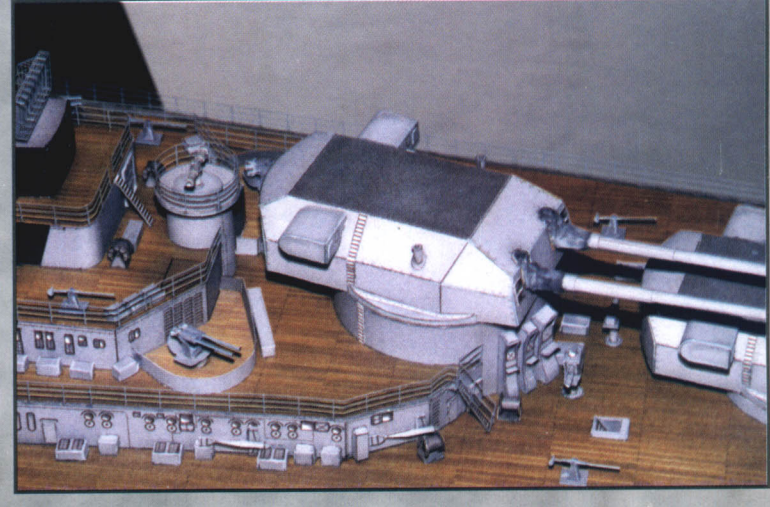
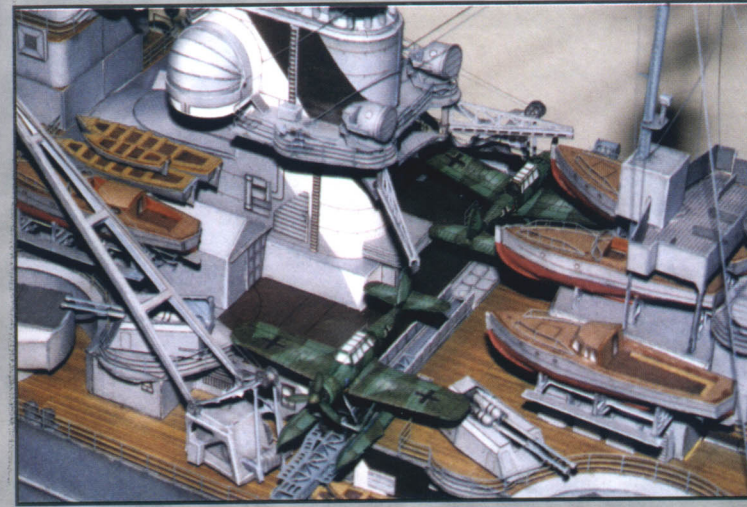
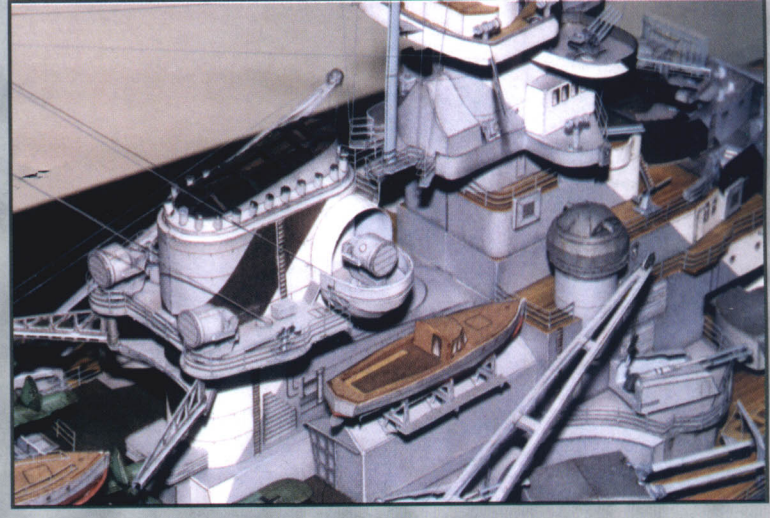
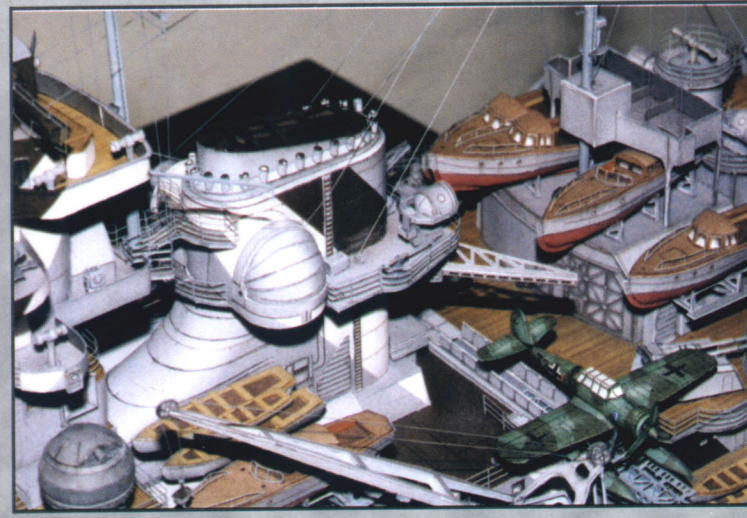
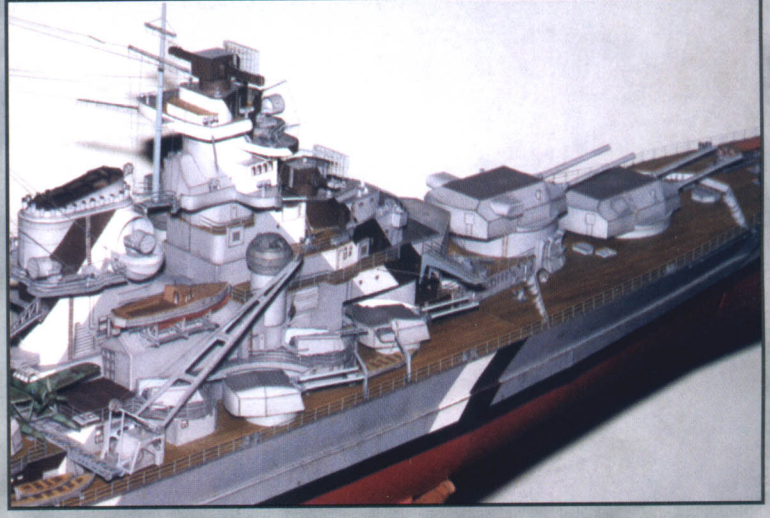
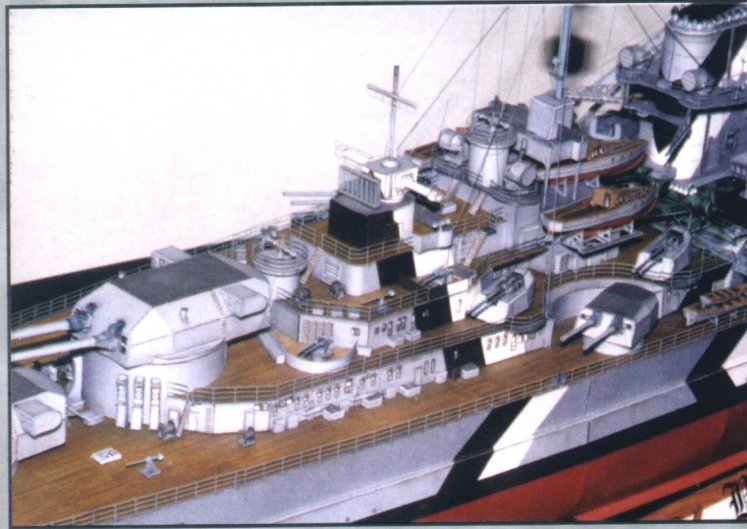
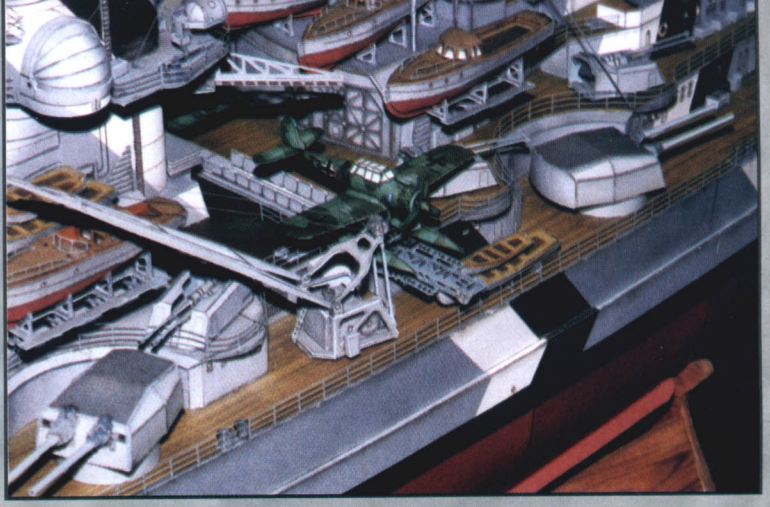
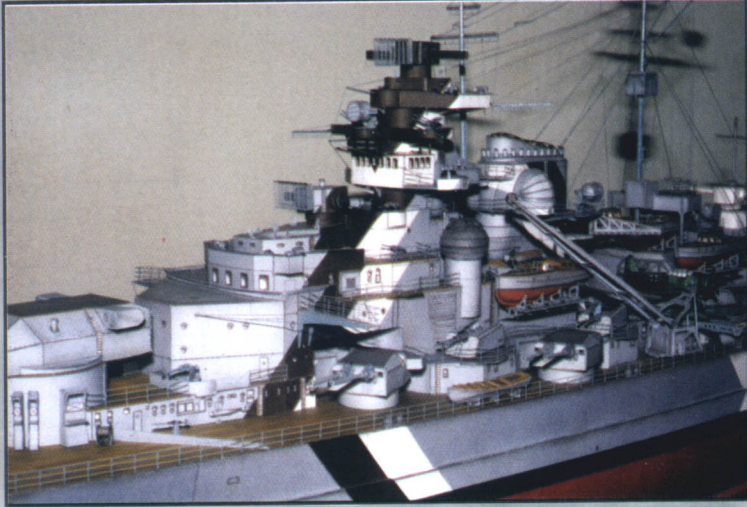

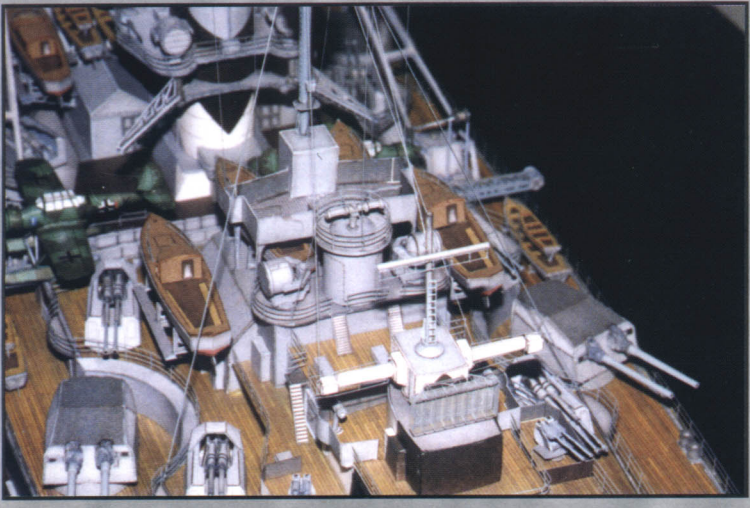
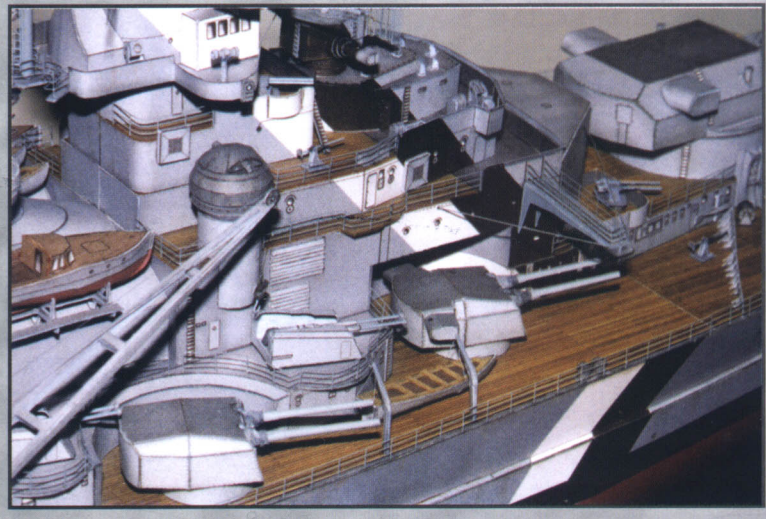
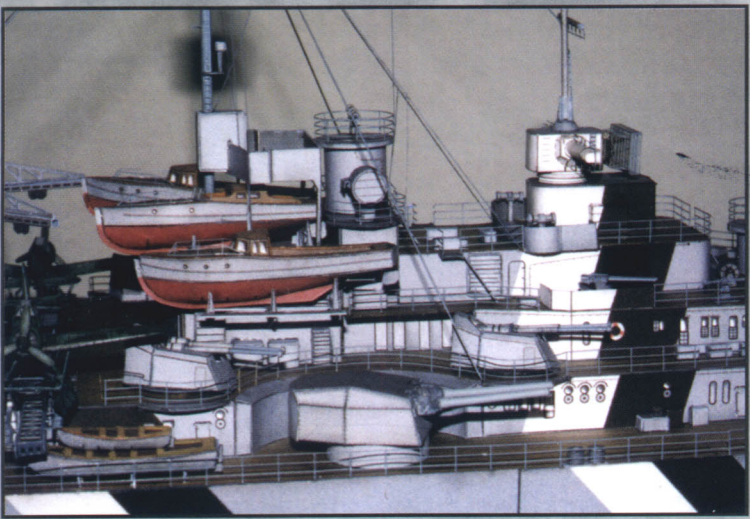
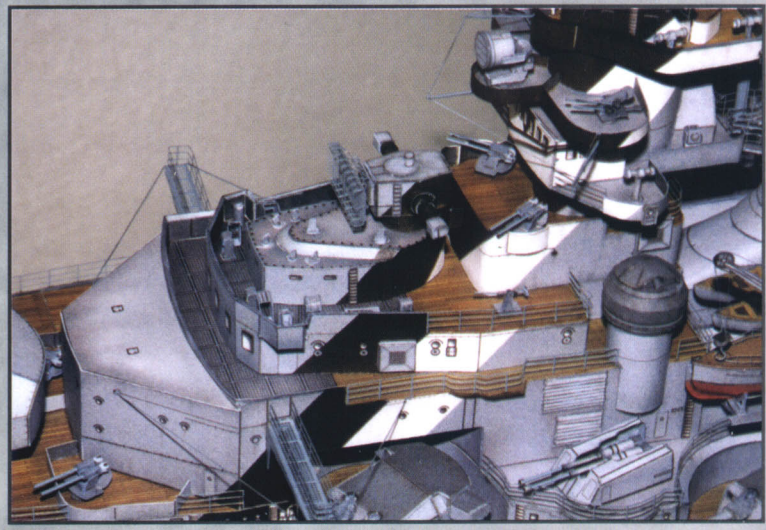

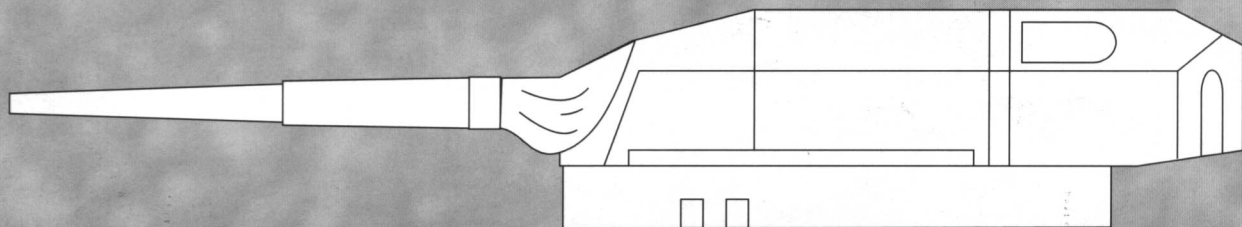
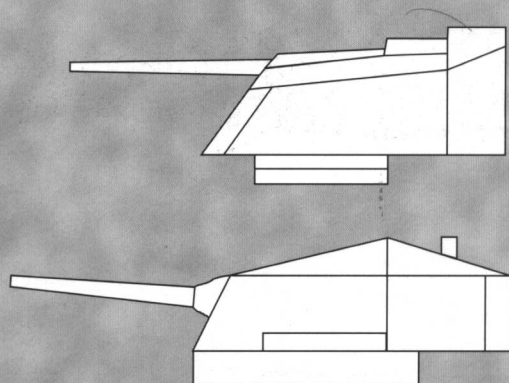
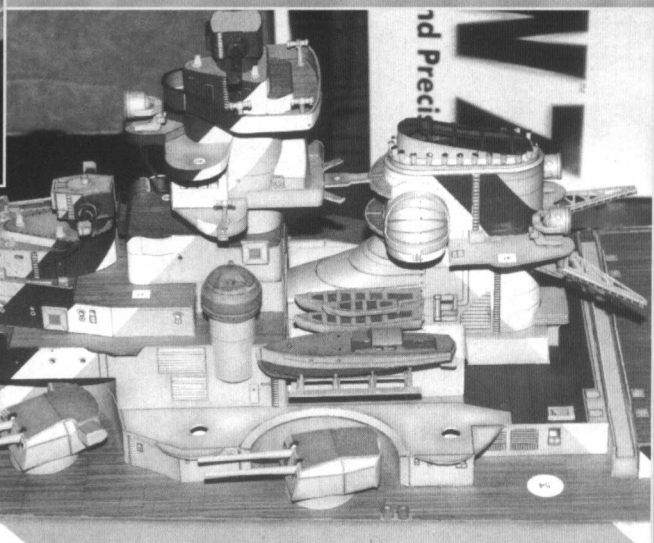
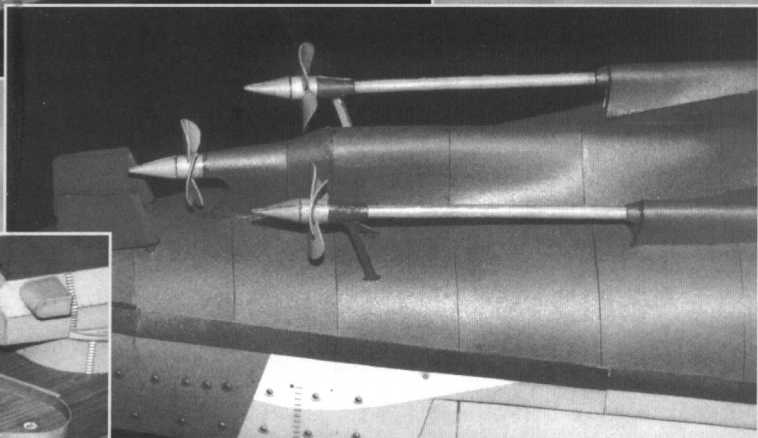
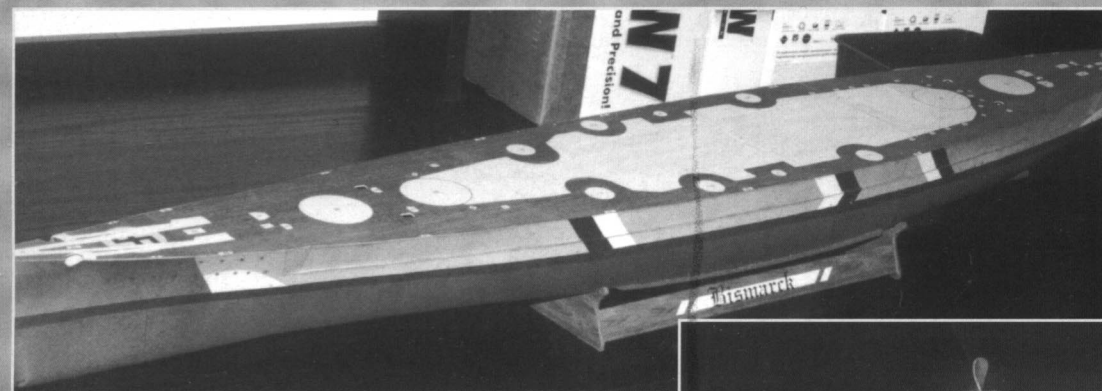

Na rysunkach przedstawiono proporcje między wielkością wież artyleryjskich a średnicą zewnętrzną.



Przed przyklejeniem pokładu należy wyciąć następujące otwory:  
-7 otworów na zejścia (cz.57)  
-2 otwory na kotwice (cz. 80)

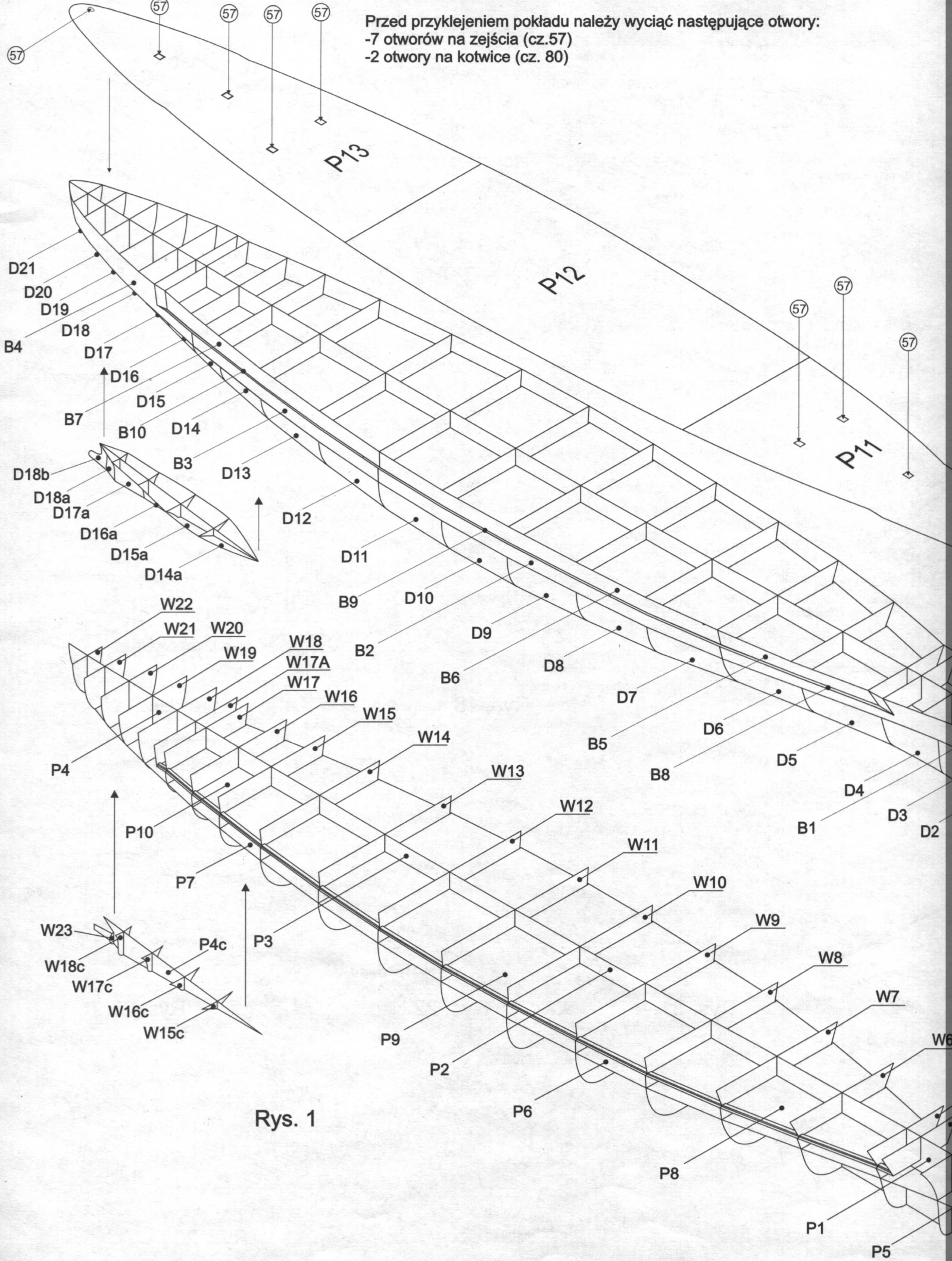

Rys. 1

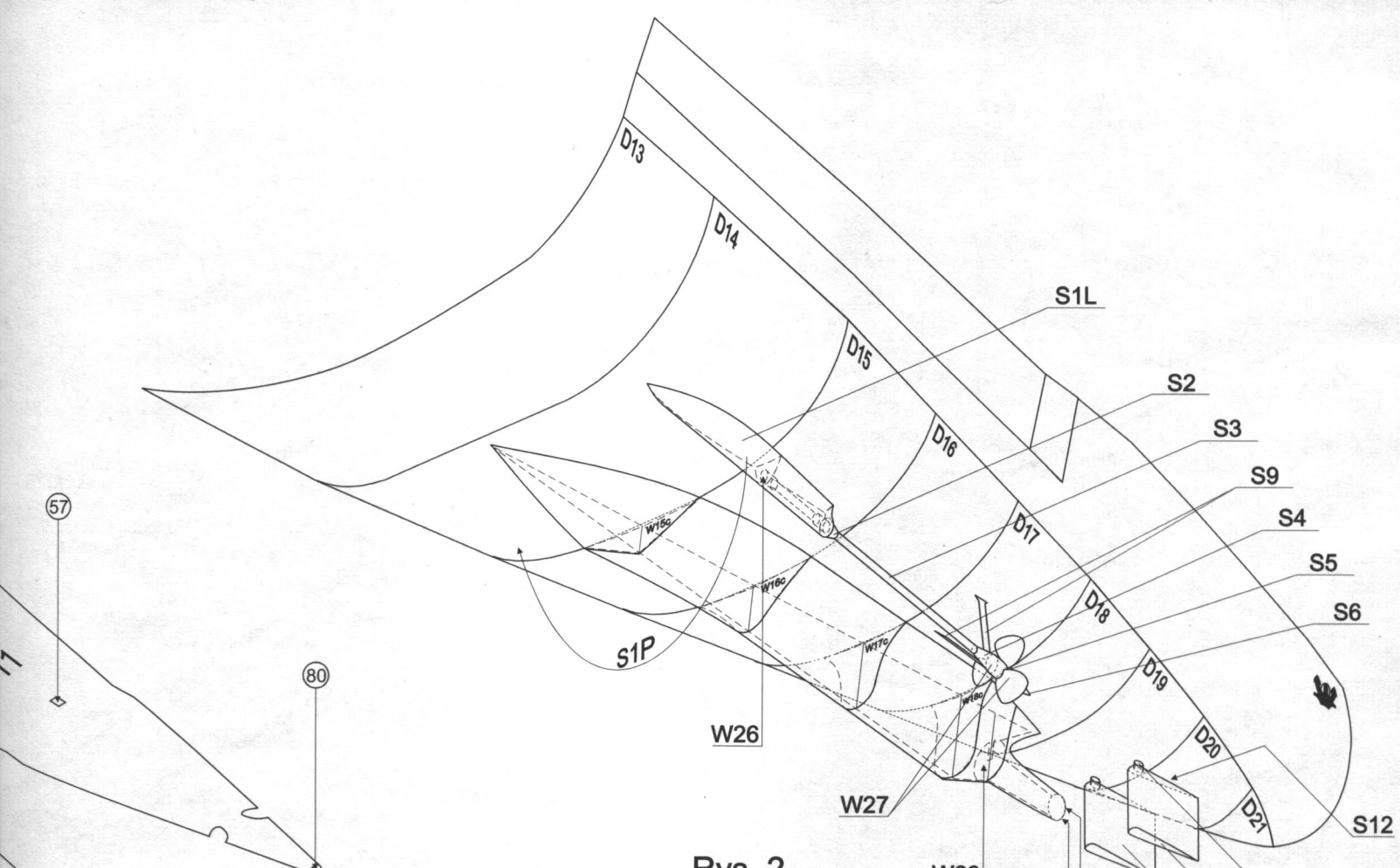

Rys. 2

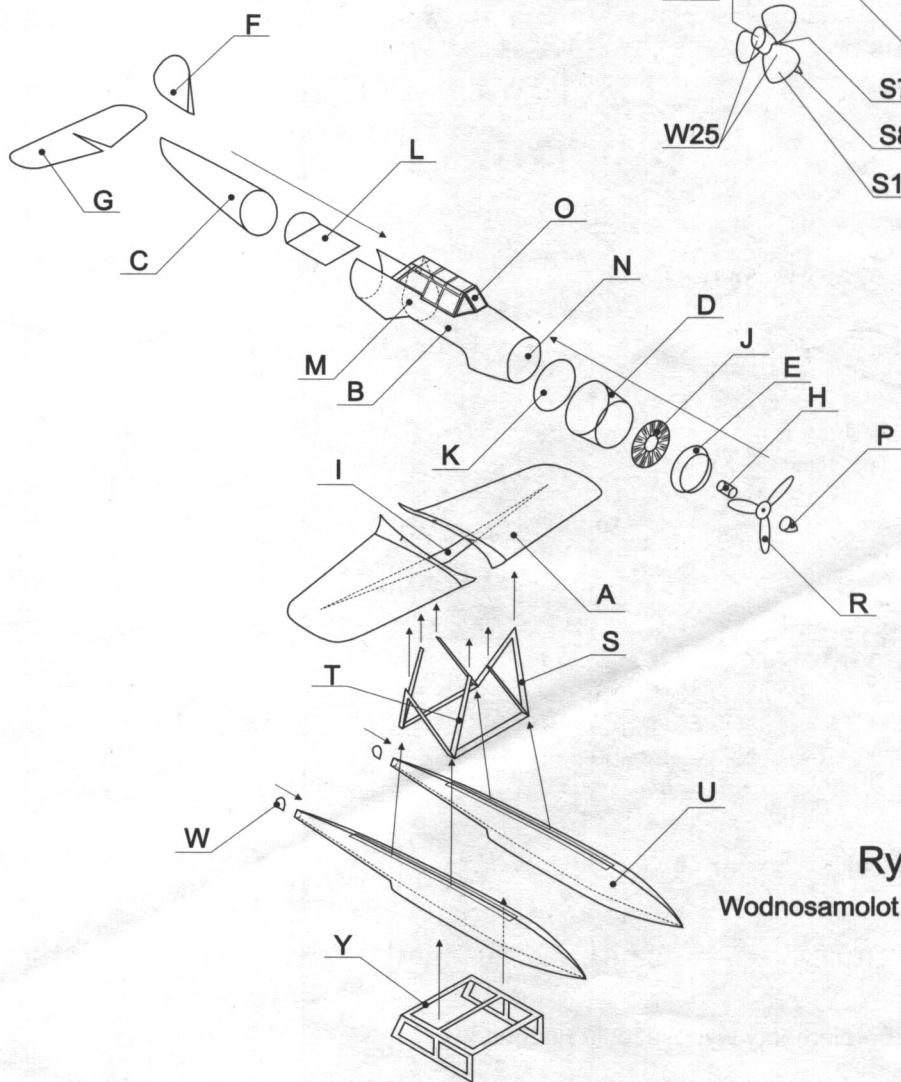
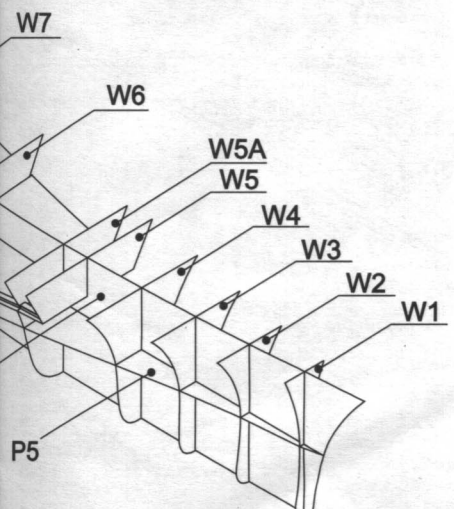
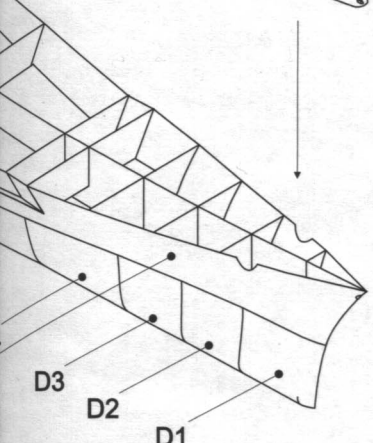

Rys. 3

Wodnosamolot ARADO 196A-1

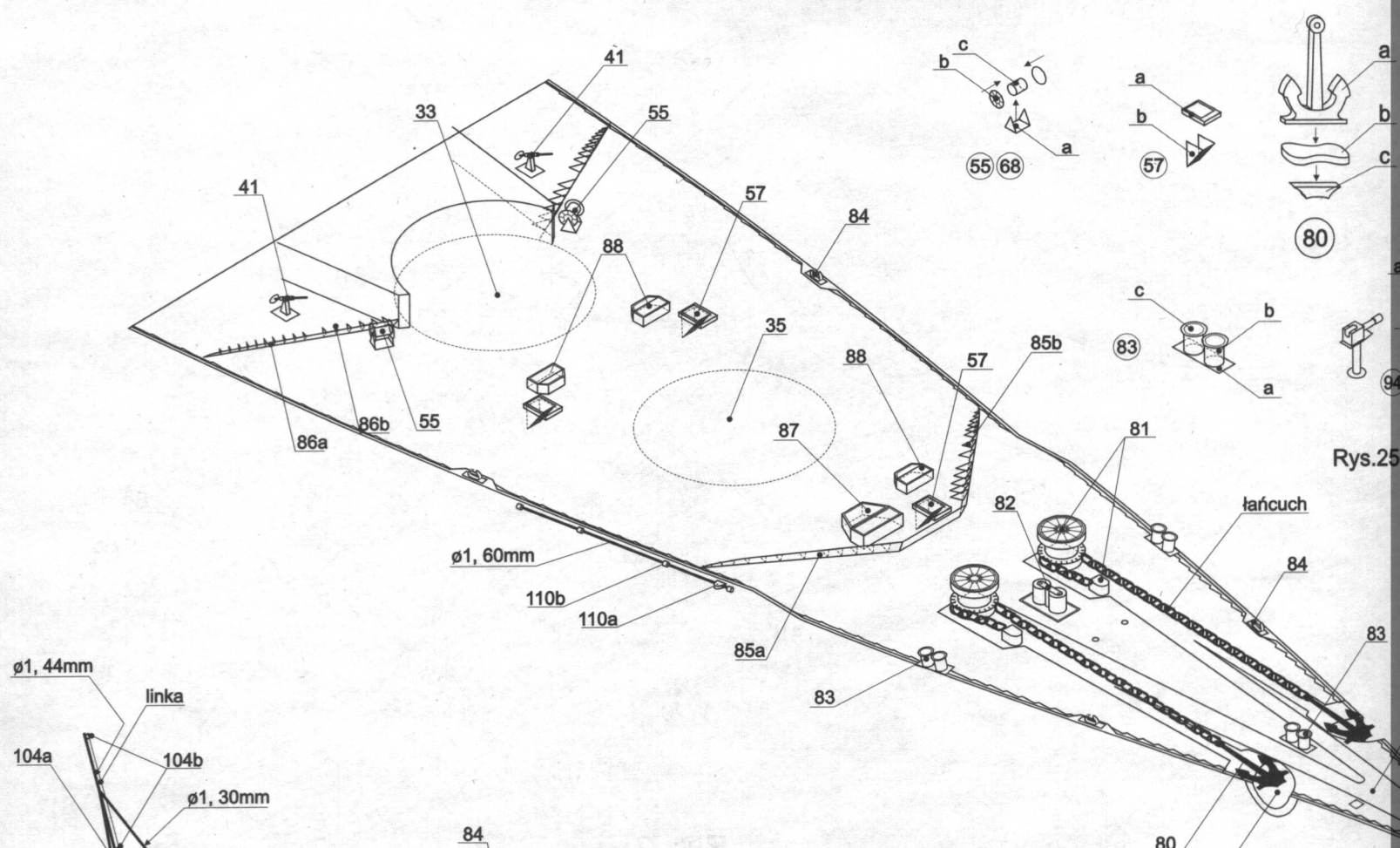

Rys. 24

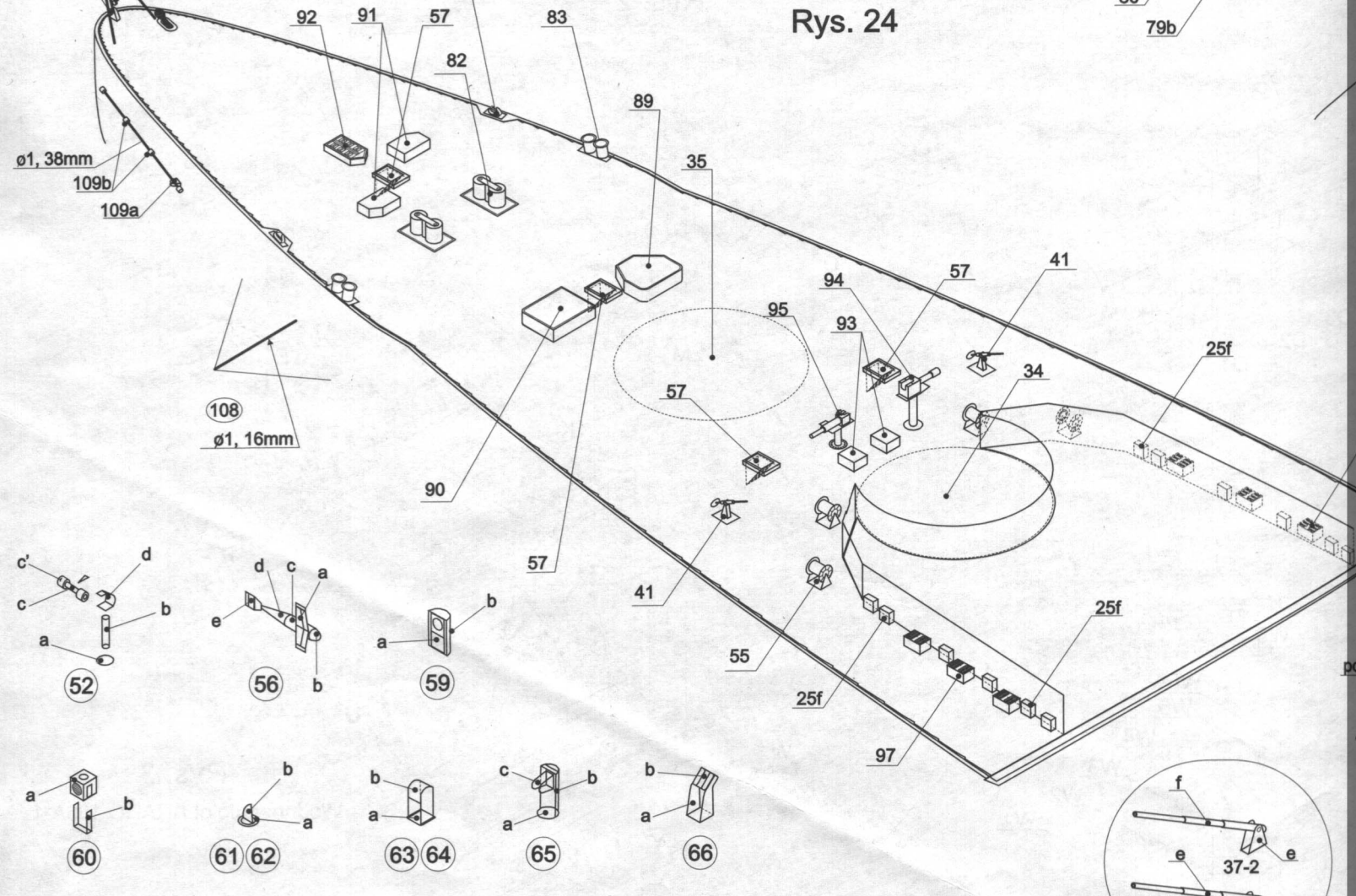

Rys. 26 - elementy wyposażenia nadbudówek

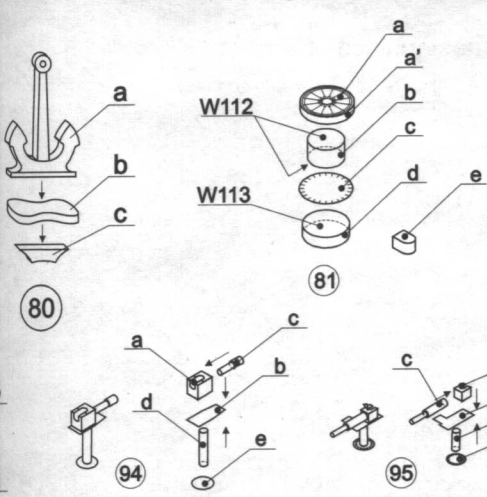

Rys.25 - elementy wyposażenia pokładów

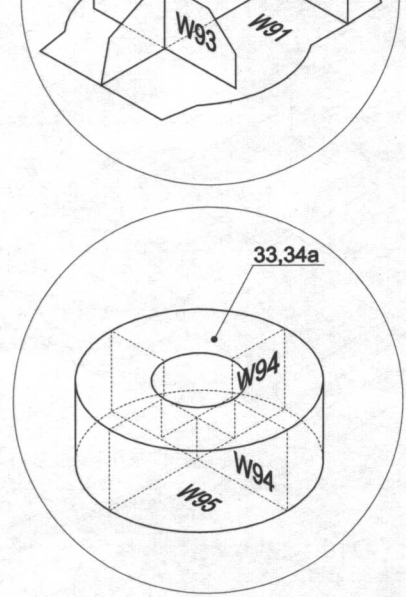
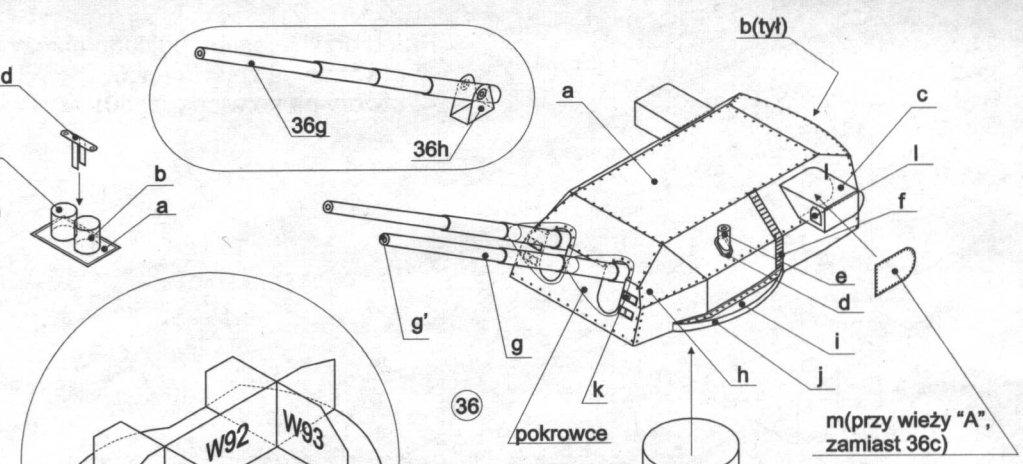
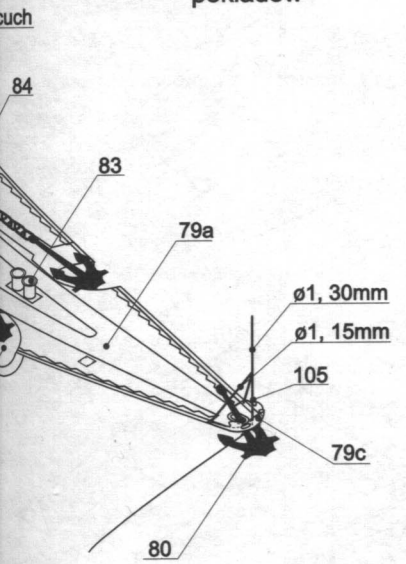

Rys. 18

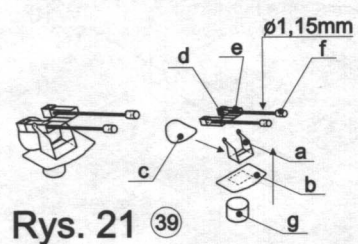

Rys. 21 (39)

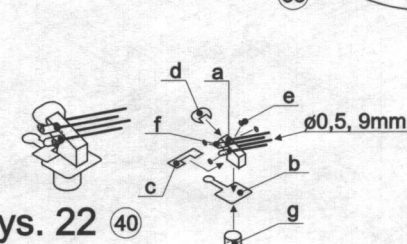

Rys. 22 (40)

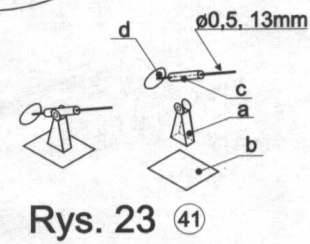

Rys. 23 (41)

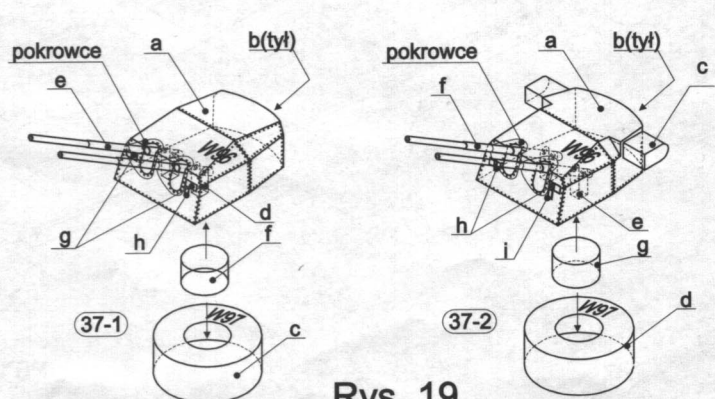

Rys. 19

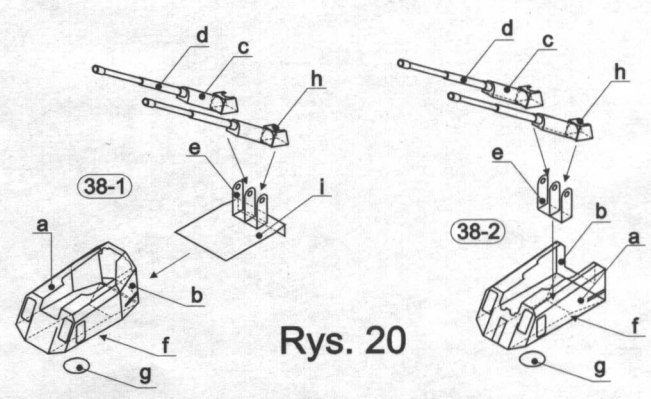

Rys. 20

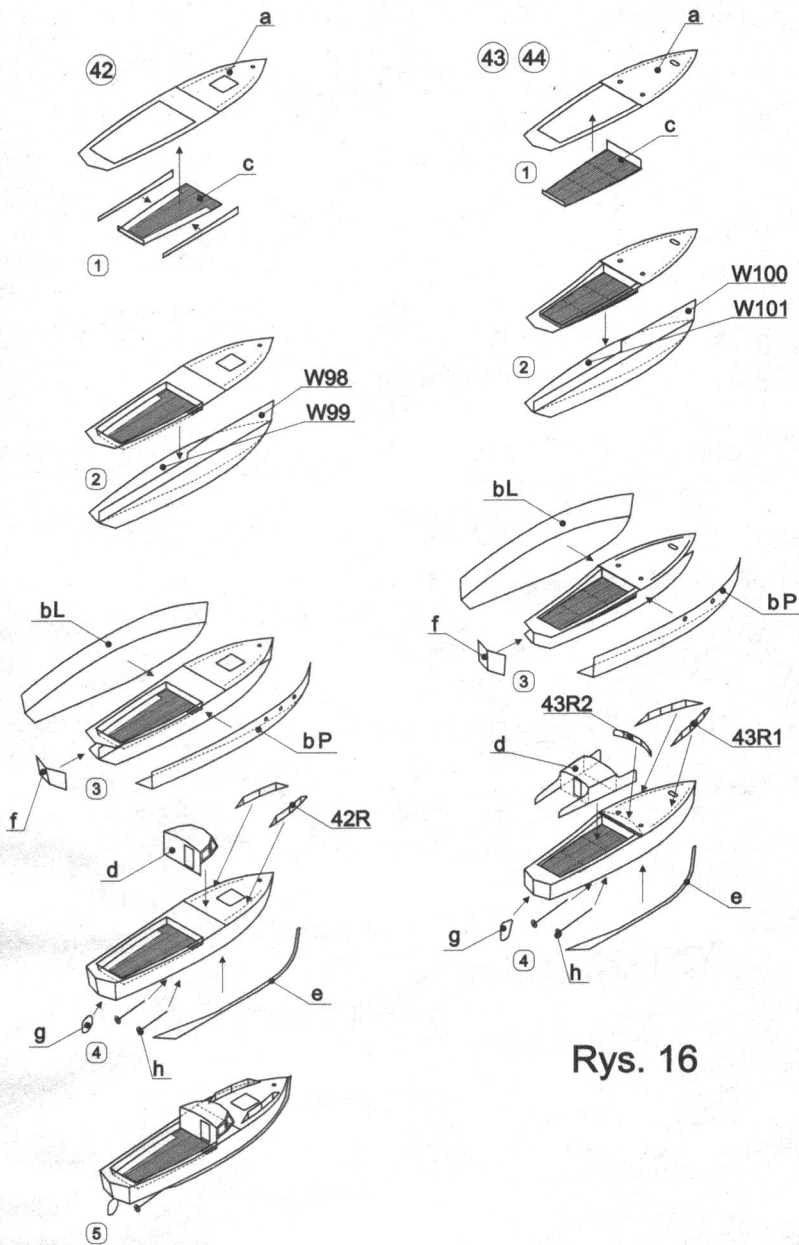

Rys. 16

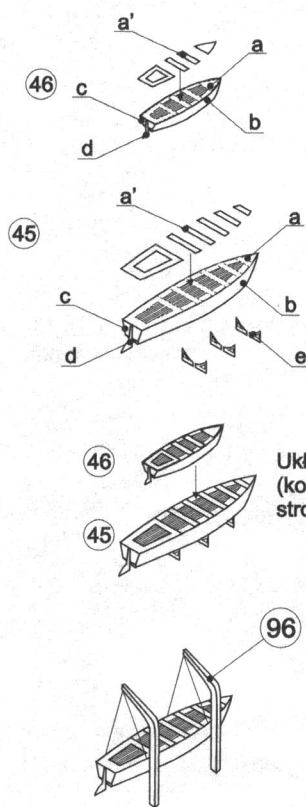

Układ szalupy na cz. P12  
(koło katapulty, na obu  
stronach)

Widok szalupy na dźwigarach  
na cz. P12 (koło przedniej wieży 37-1)  
- tylko na str. P, na str. L szalupa jest  
przyklejona do pokładu na wspornikach 45e.

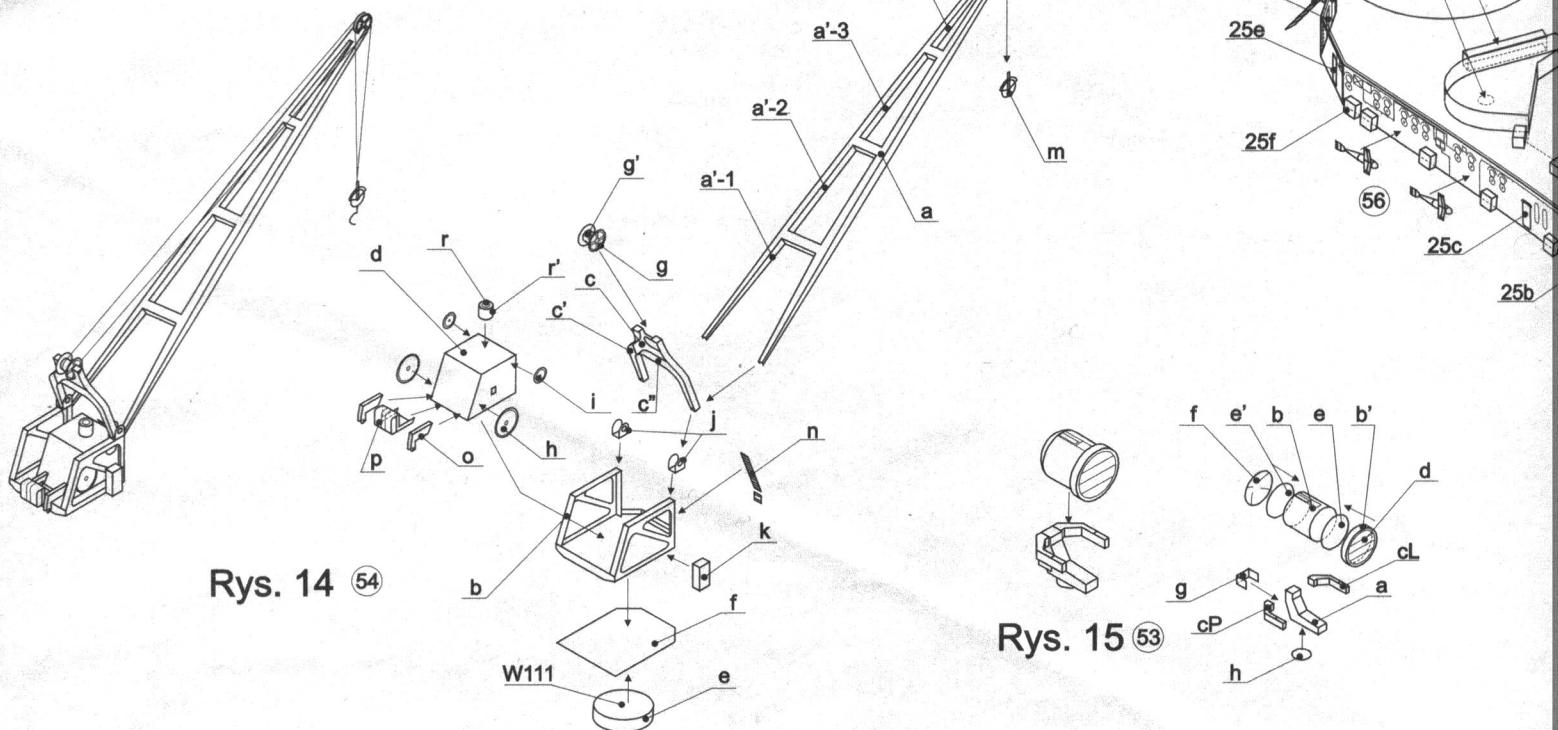

Rys. 14 54

Rys. 15 53



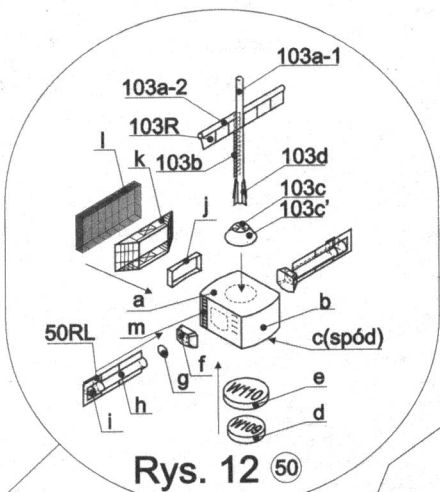

Rys. 12 50

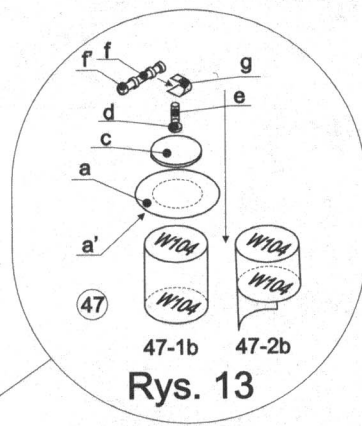

Rys. 13

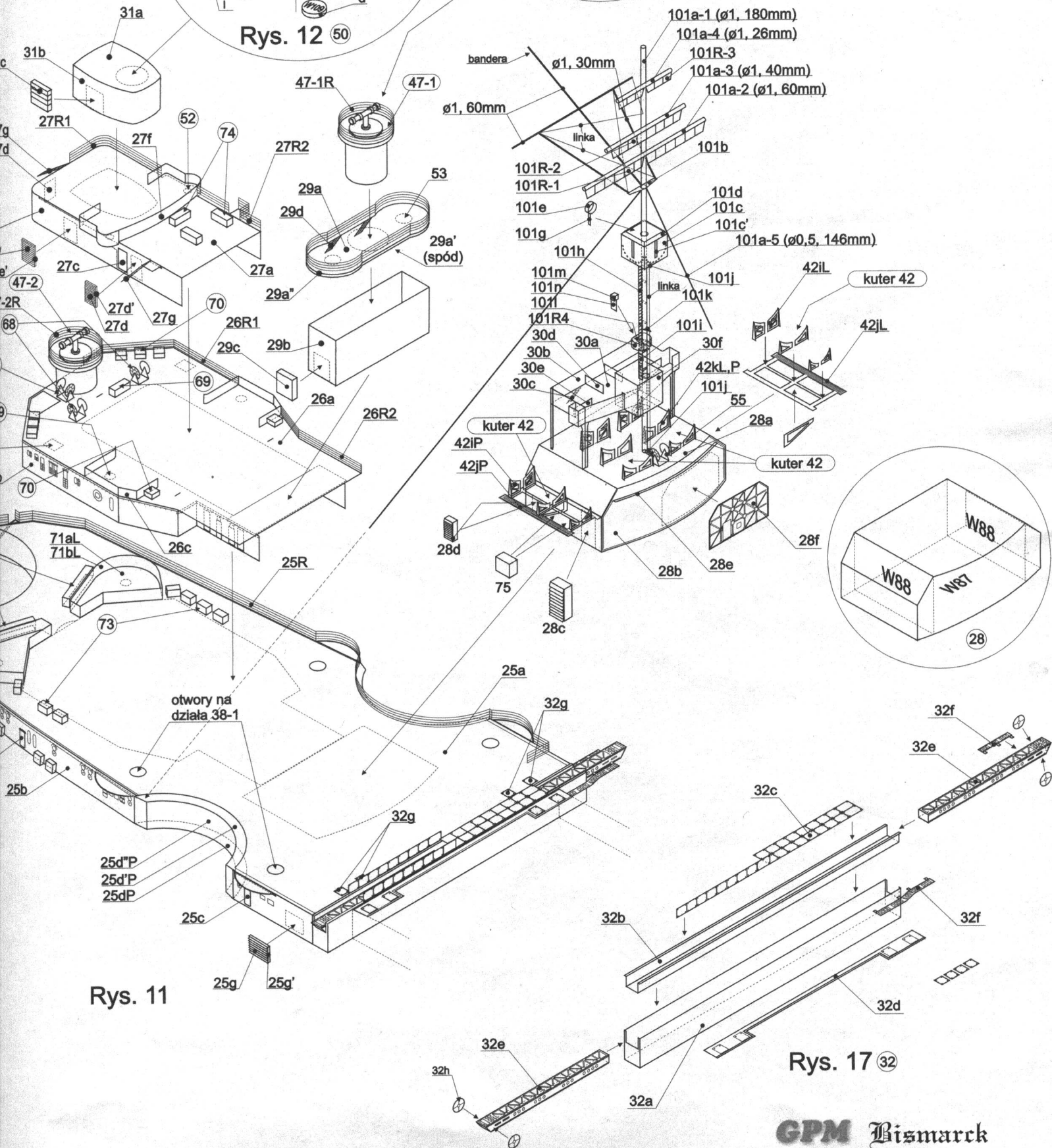

Rys. 11

Rys. 17 32

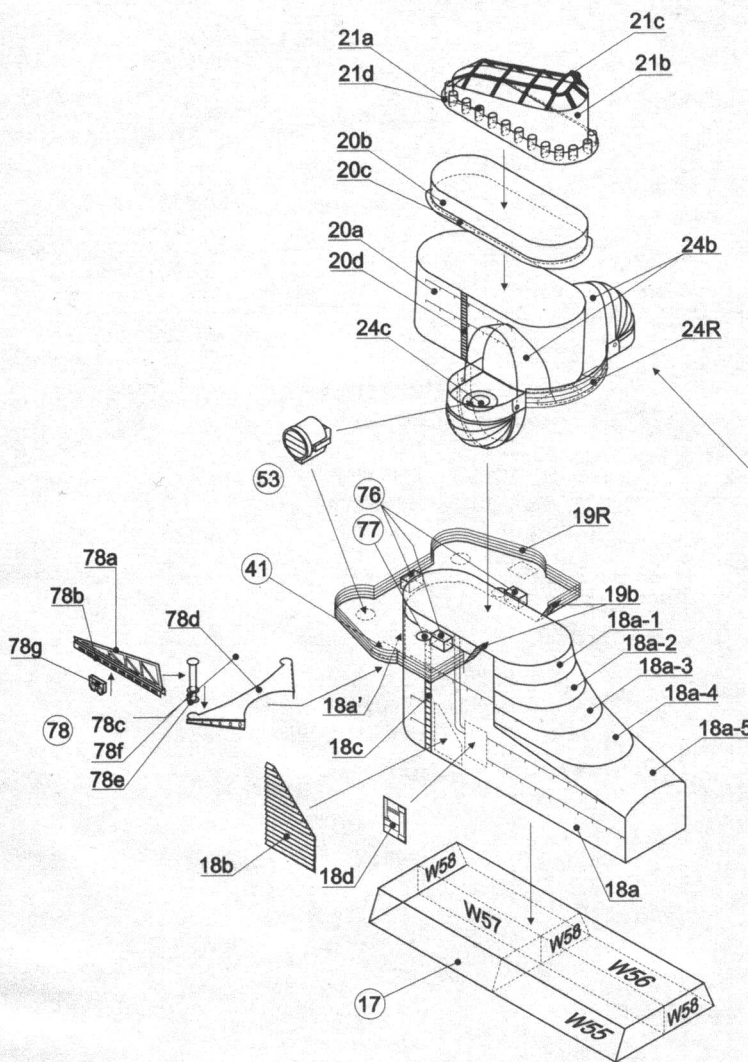

Rys. 10

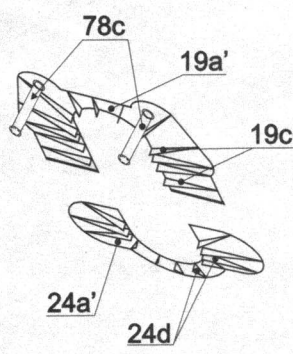
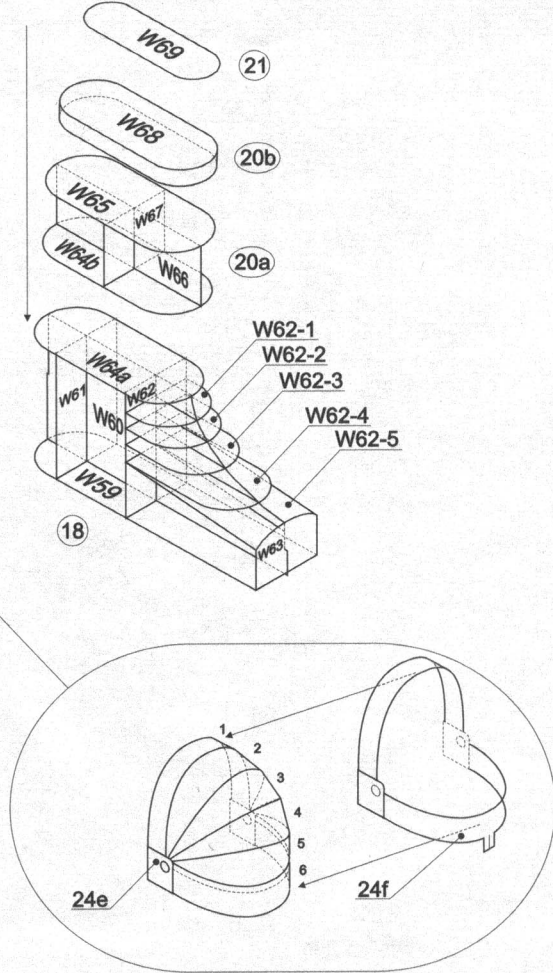

Rys. 8

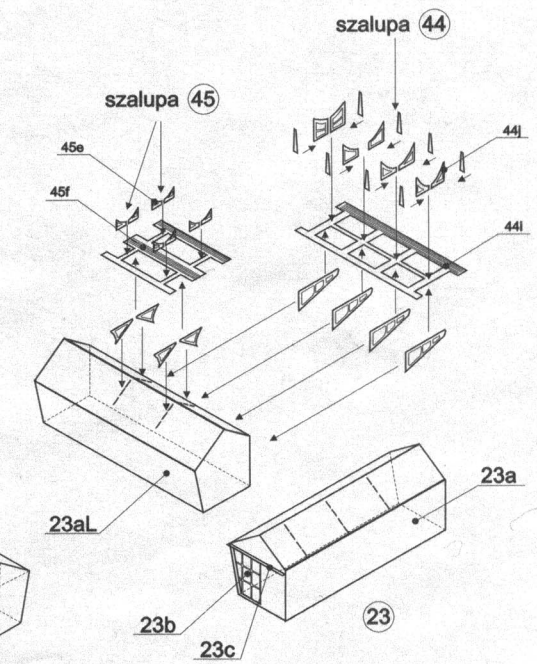
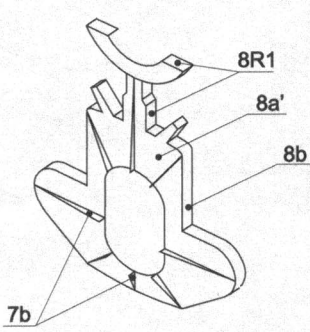

Rys. 9

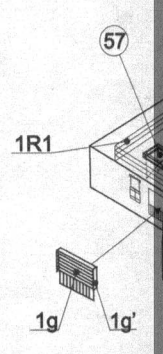
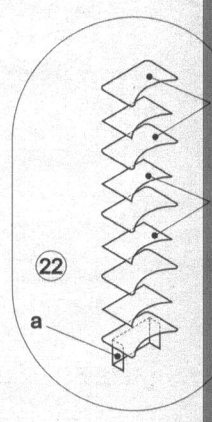
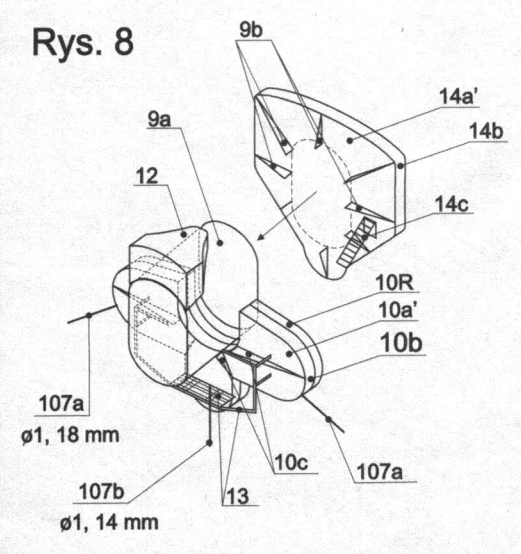

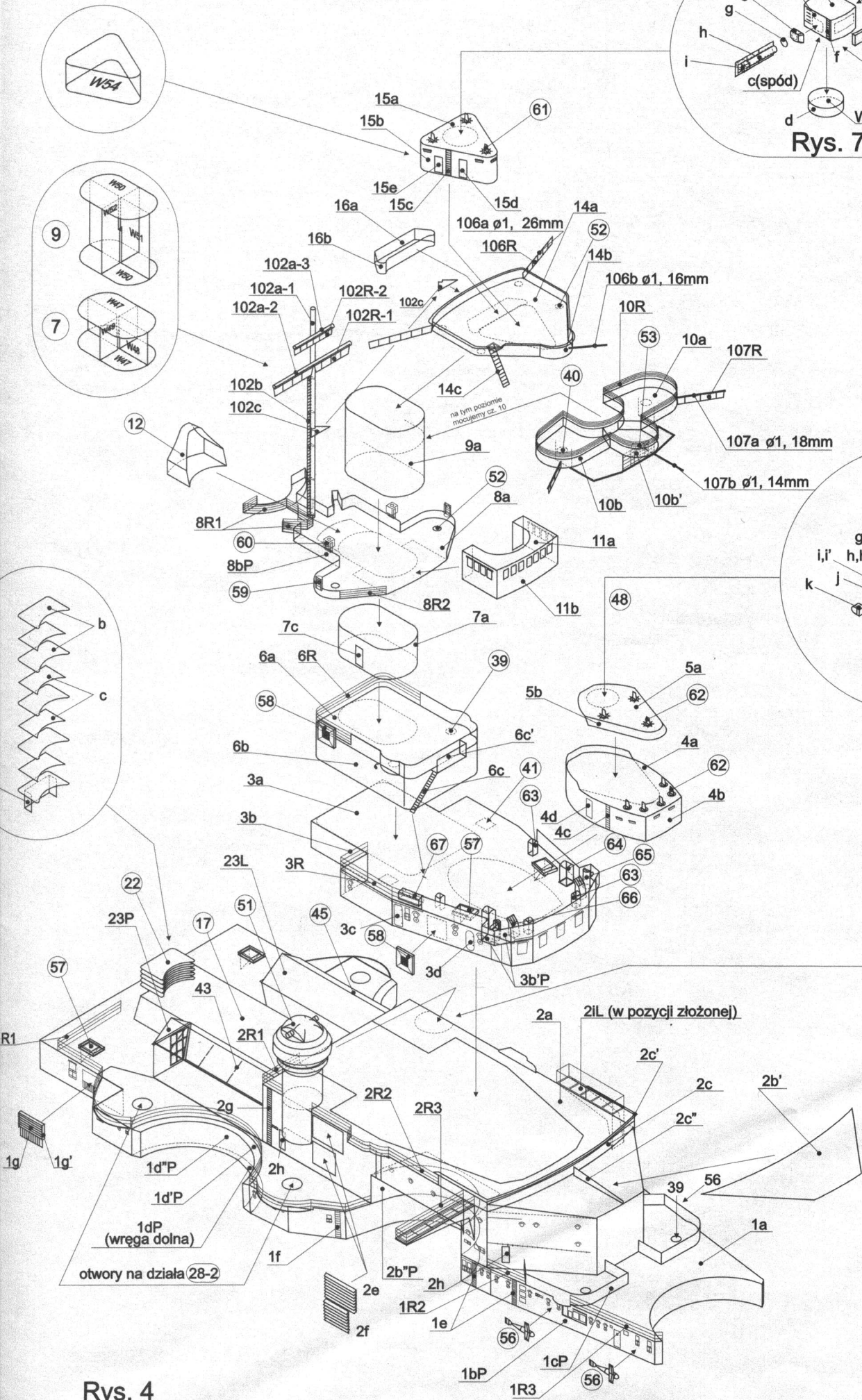

Rys. 4

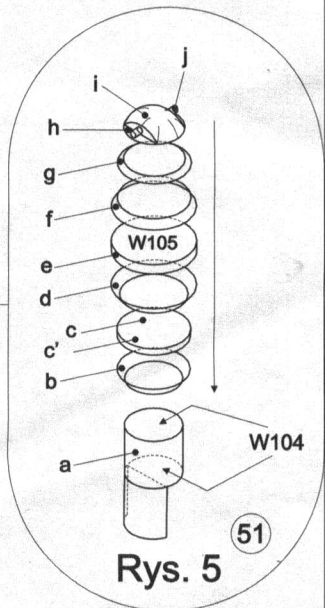
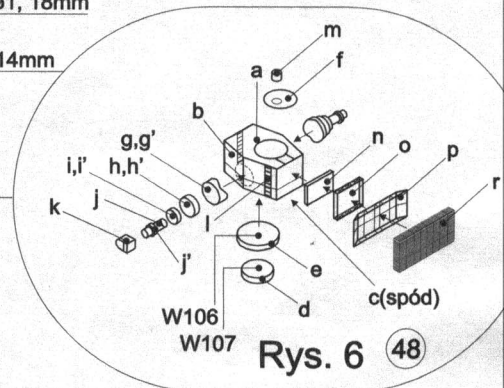
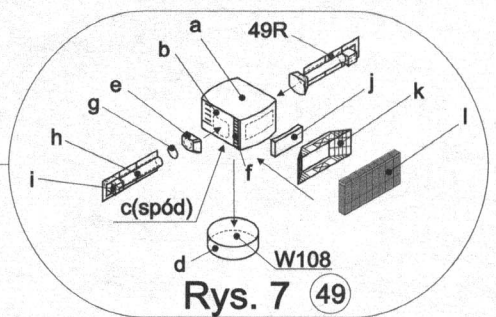



+

D7

D6

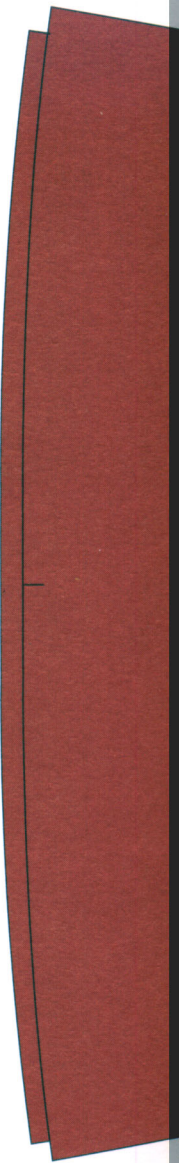
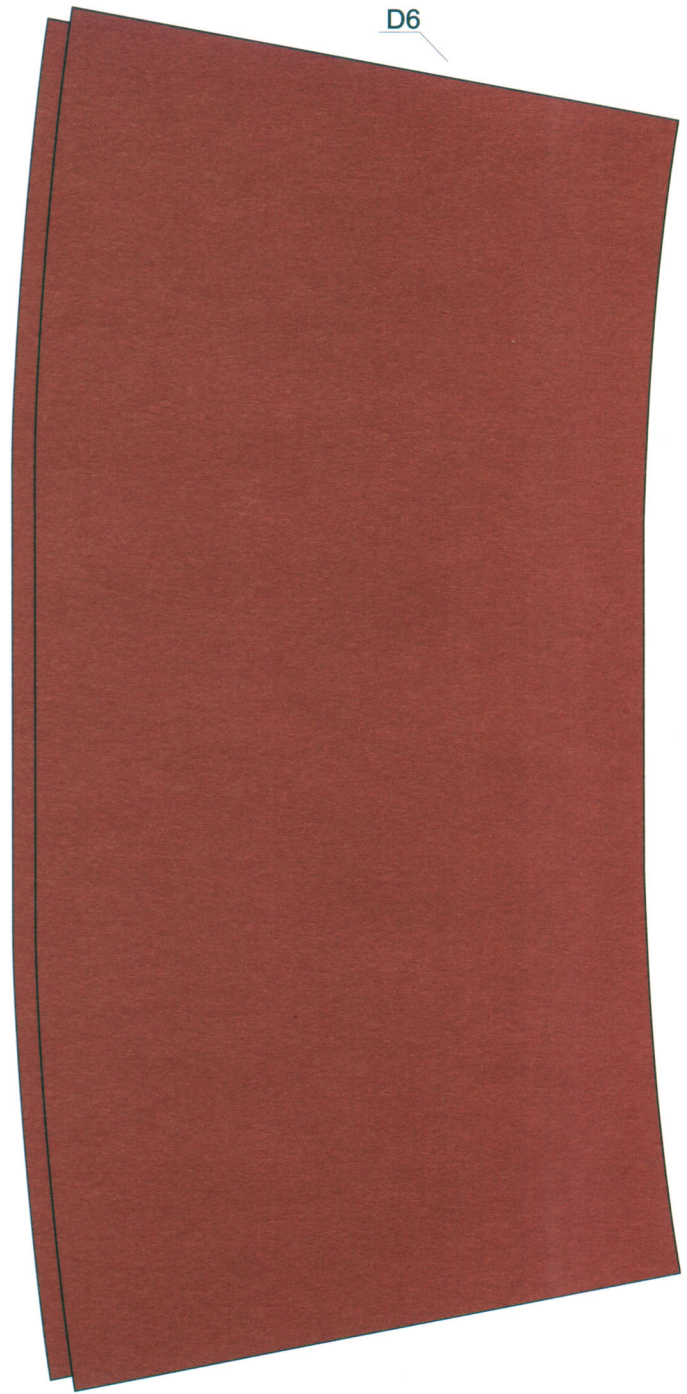

D20



D17a

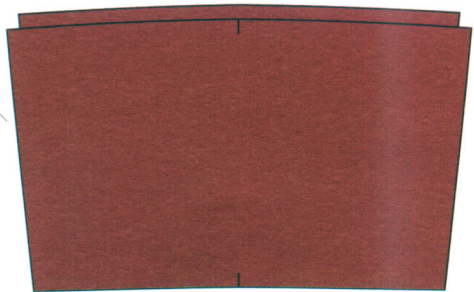

D19

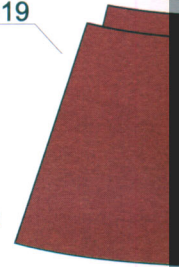

D15a

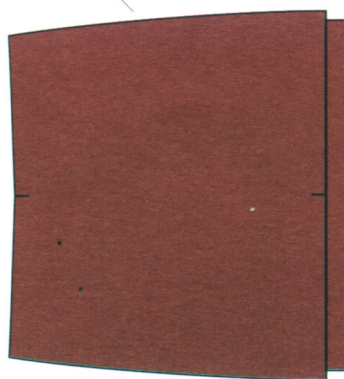

D14a

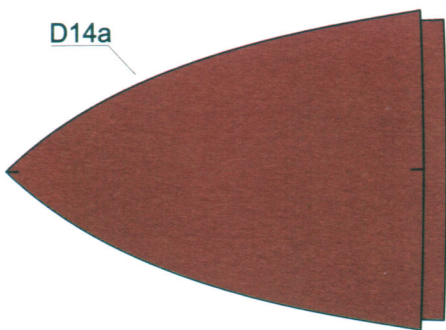

D16a

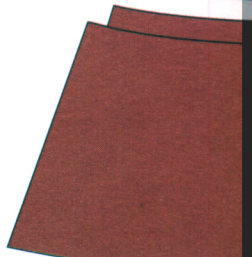
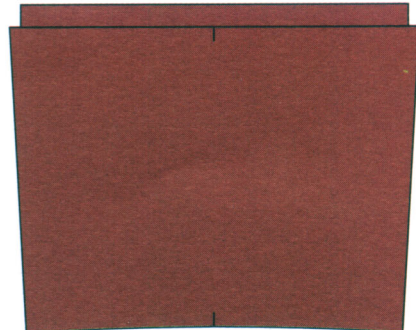

D6

D5

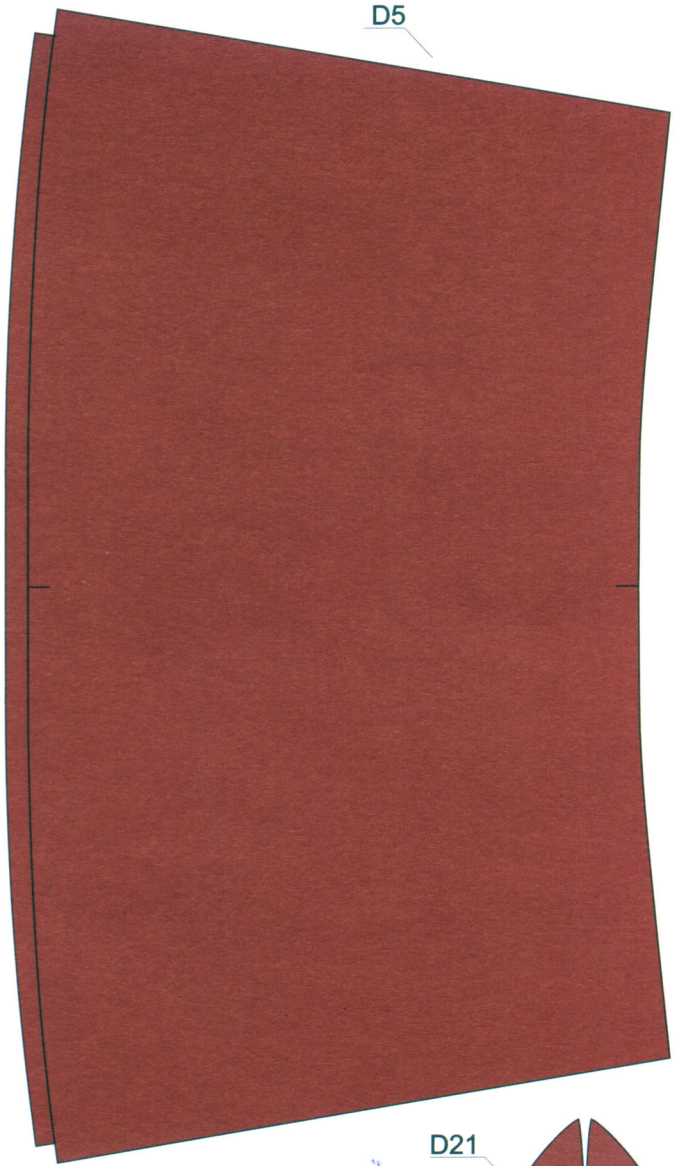

D21

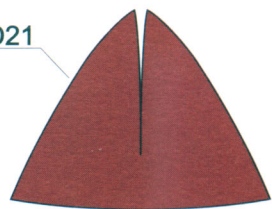

D20



D17a

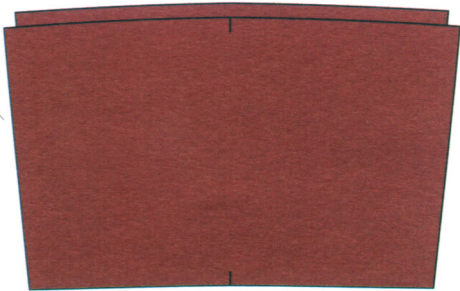

D19

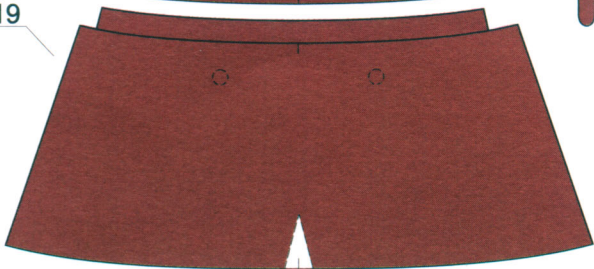

S11



D16a

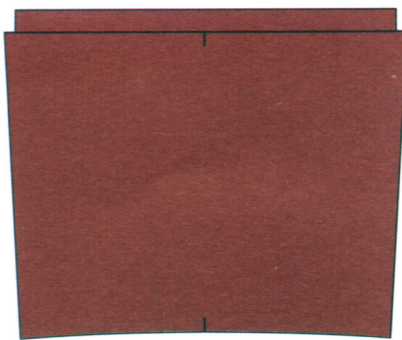

D18

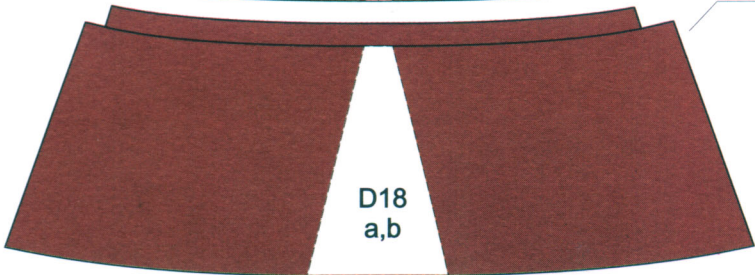

D18  
a,b

S12



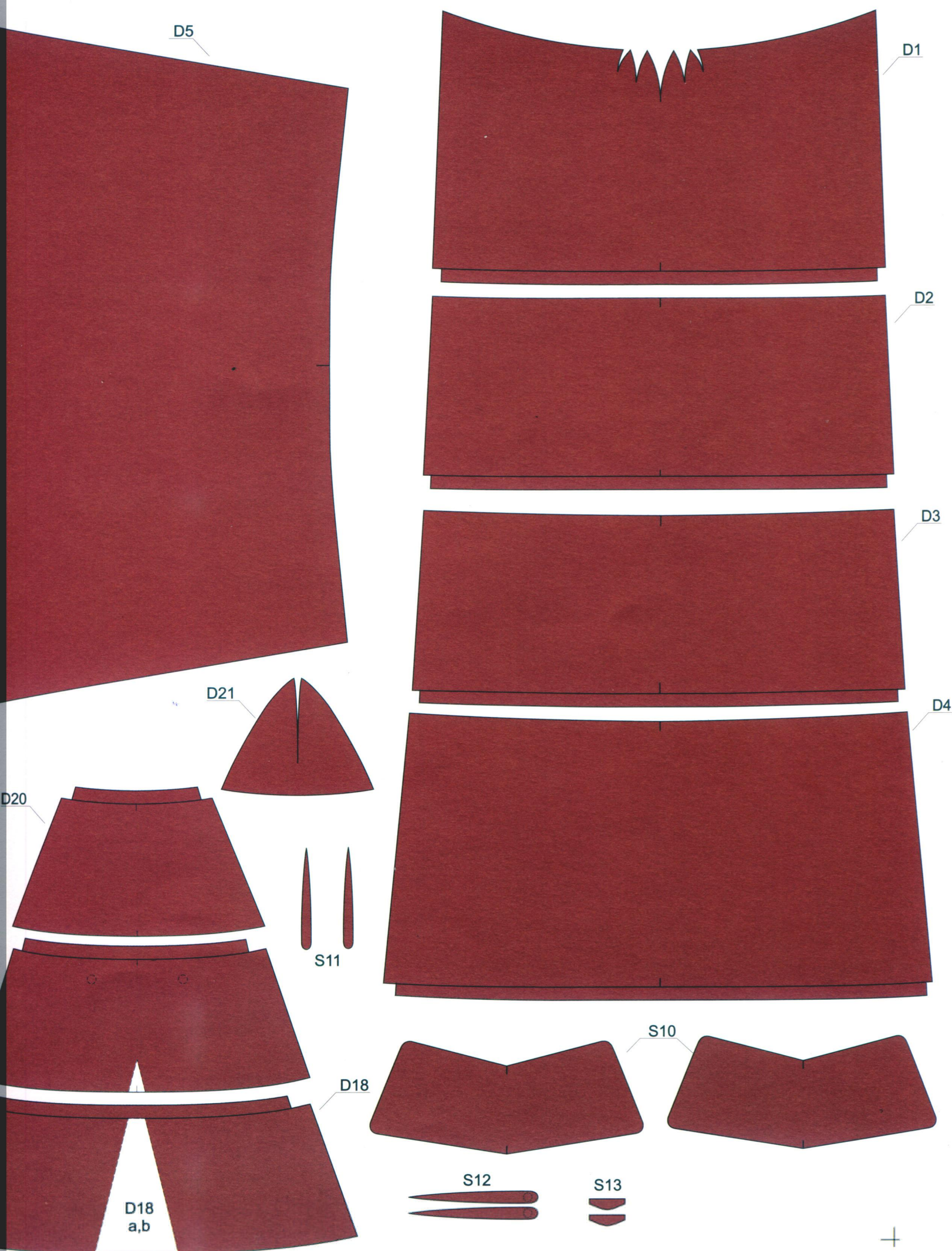

D5

D1

D2

D3

D4

D21

D20

S11

D18

S10

D18  
a,b

S12

S13

D11

D10

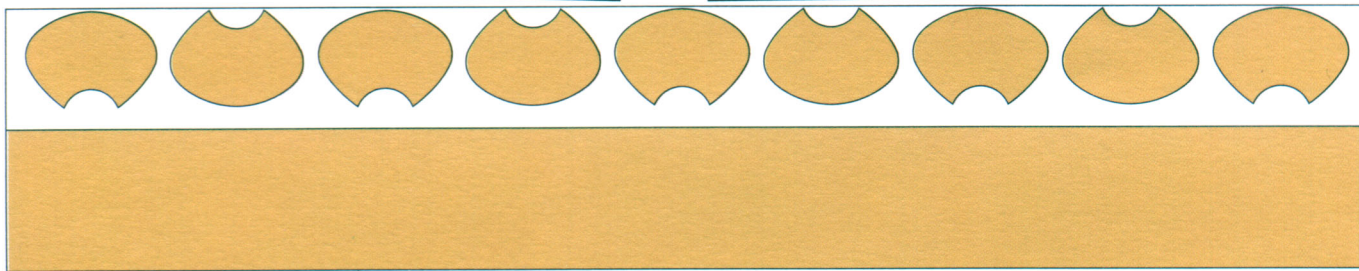
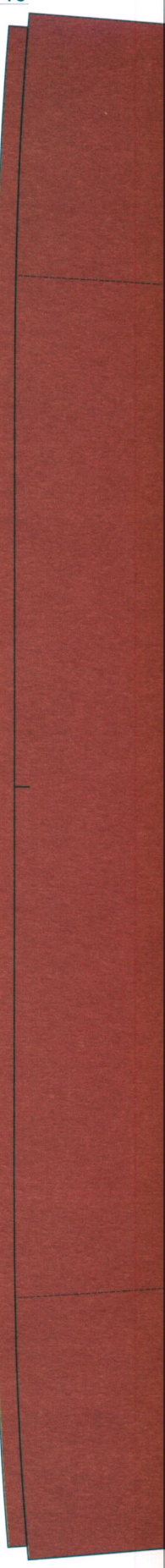
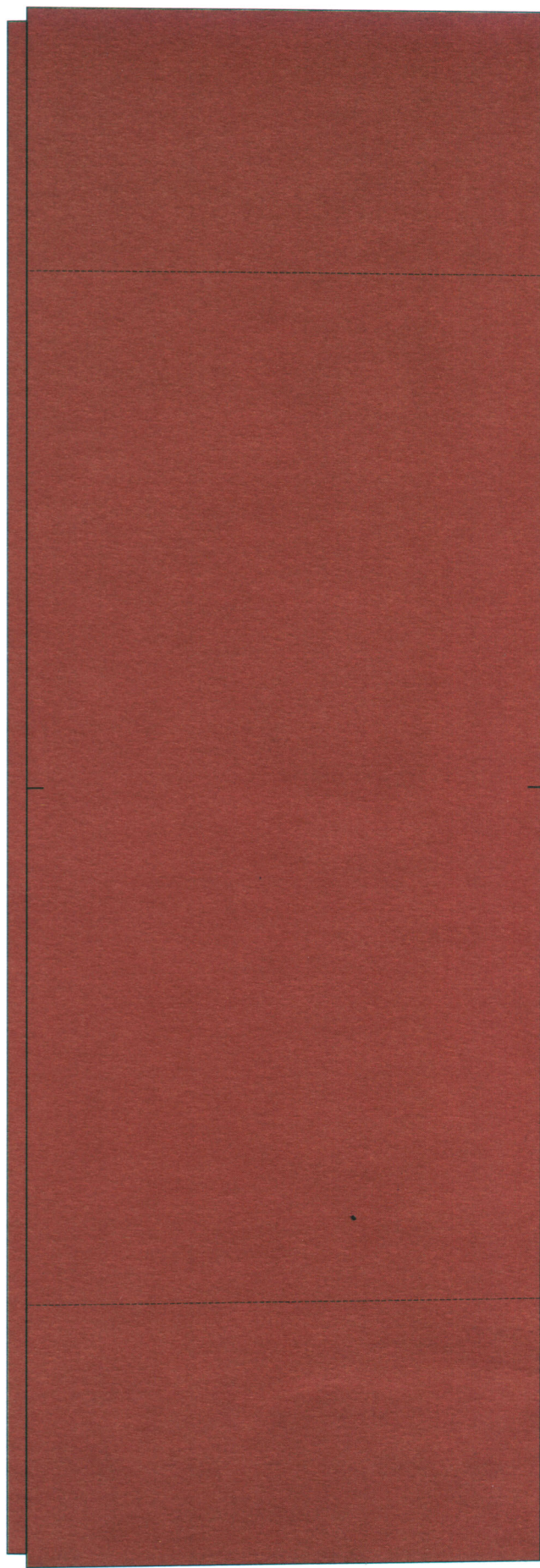
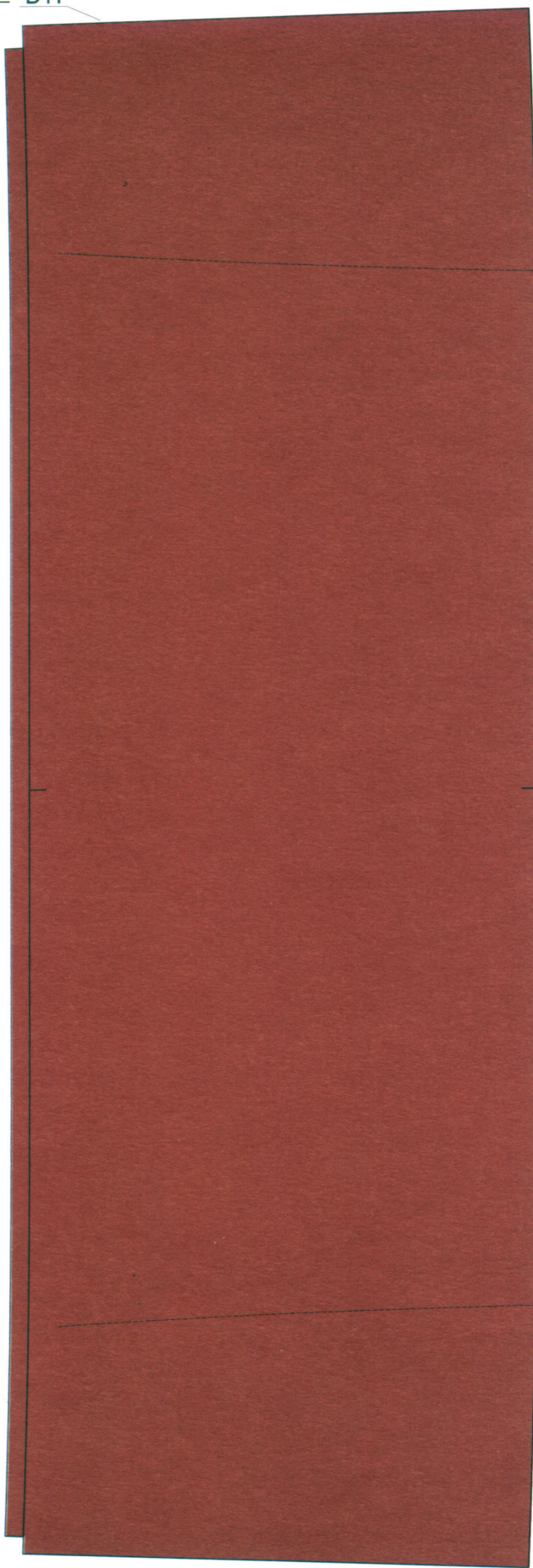

S14

D10

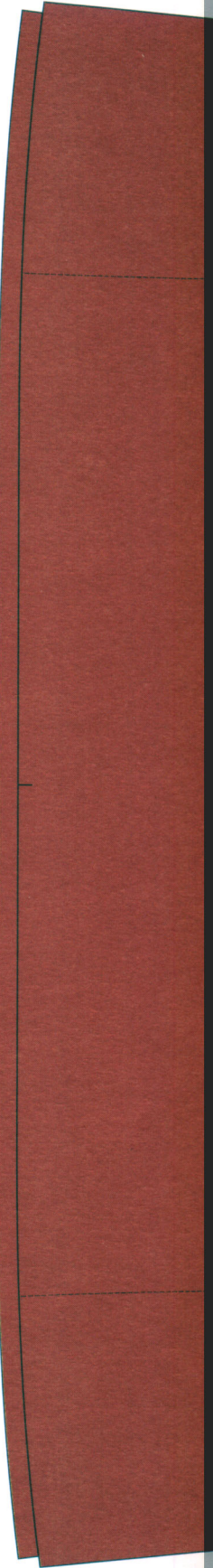
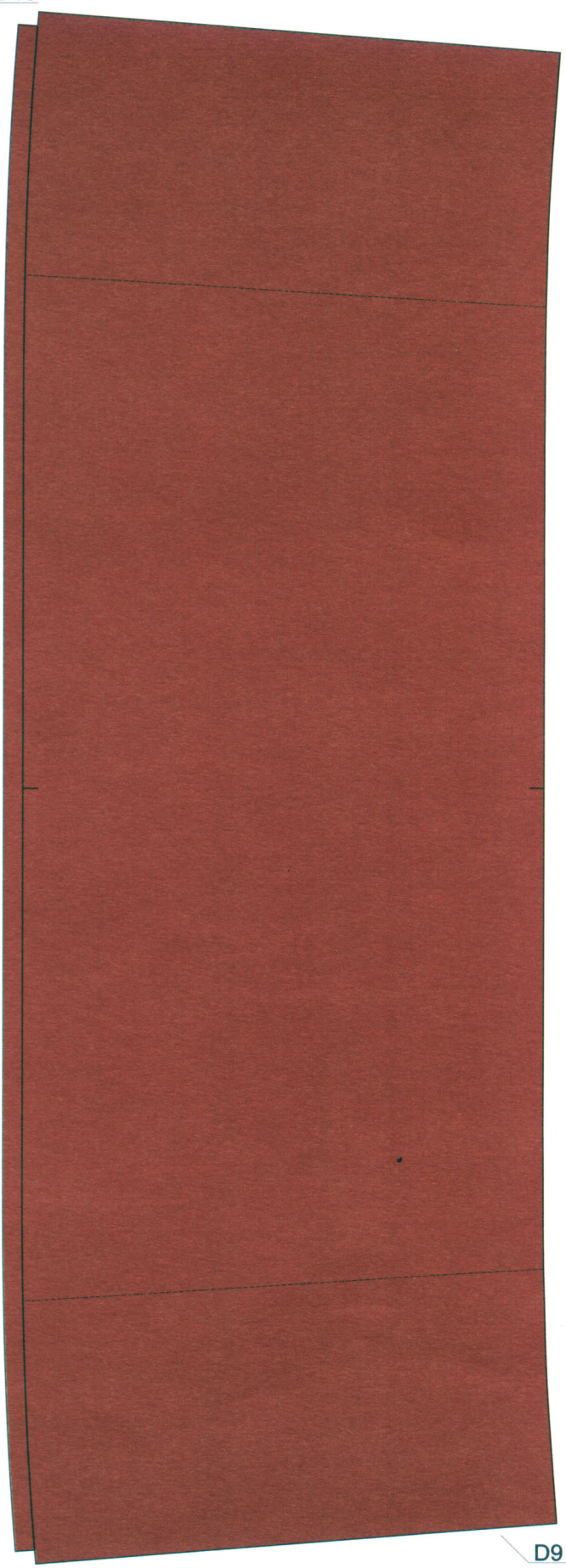
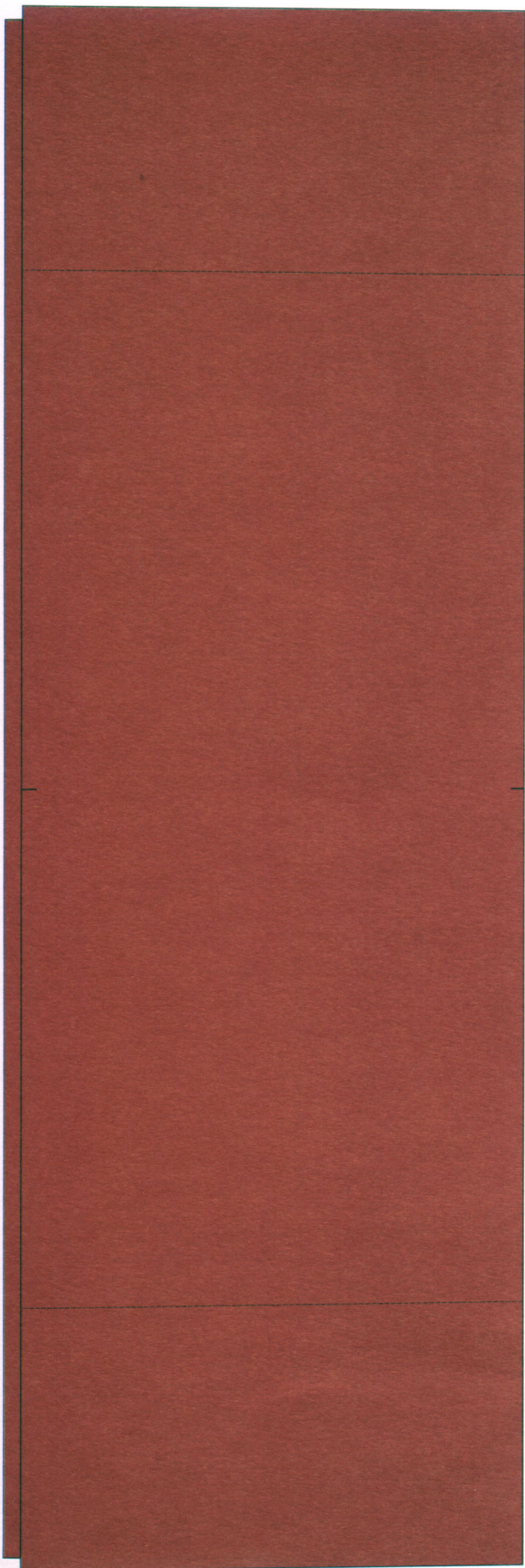

Zapas koloru

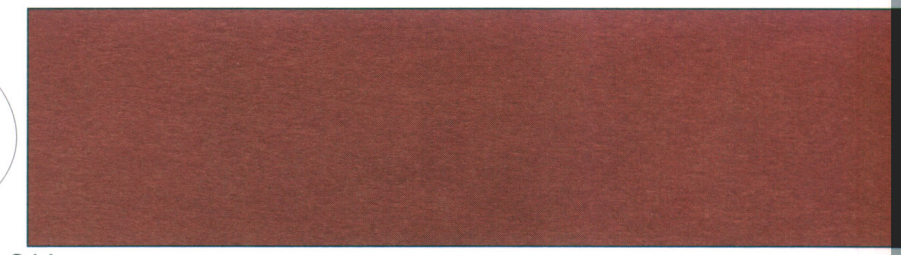
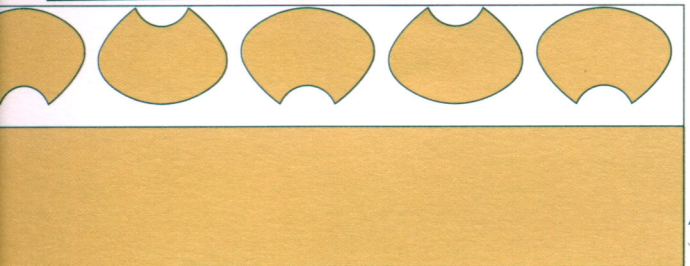

S14

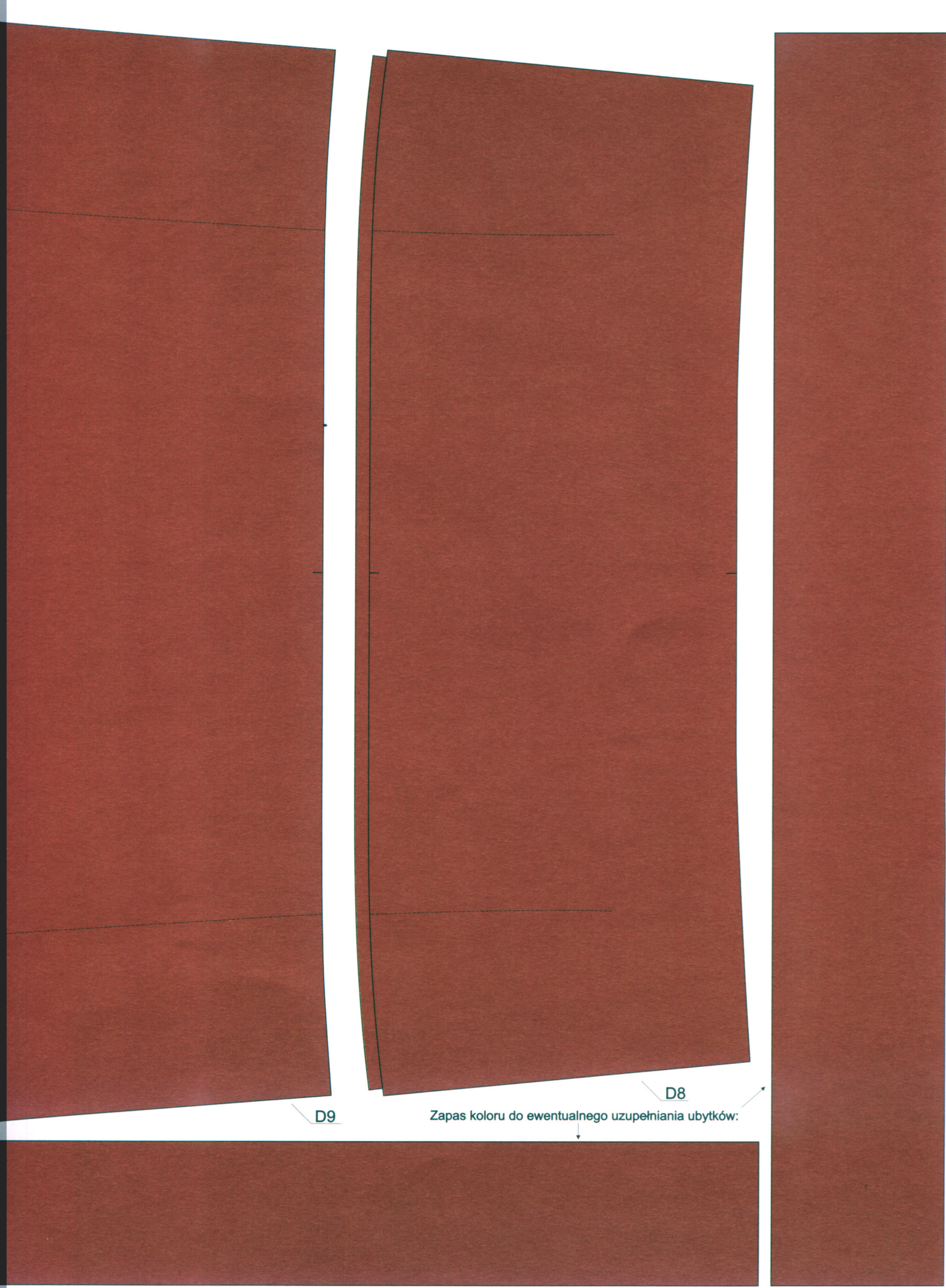

D9

D8

Zapas koloru do ewentualnego uzupełnienia ubytków:

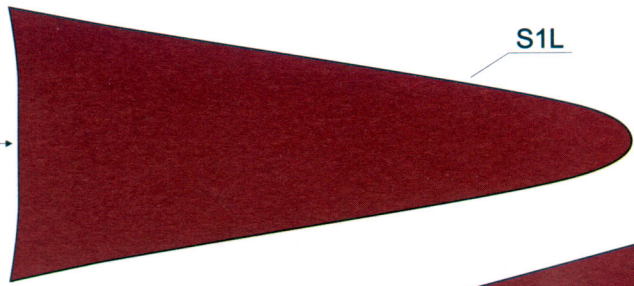
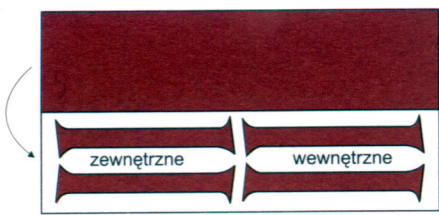

D14

D15

D16

D17

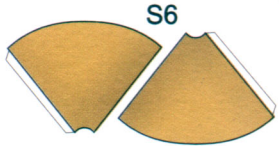
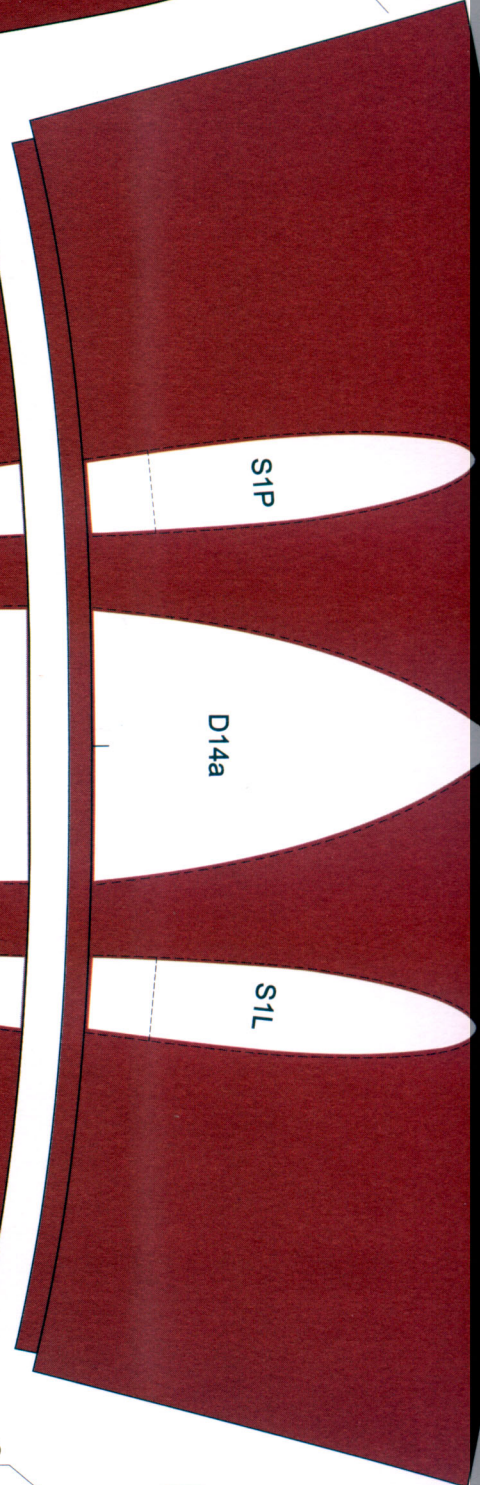
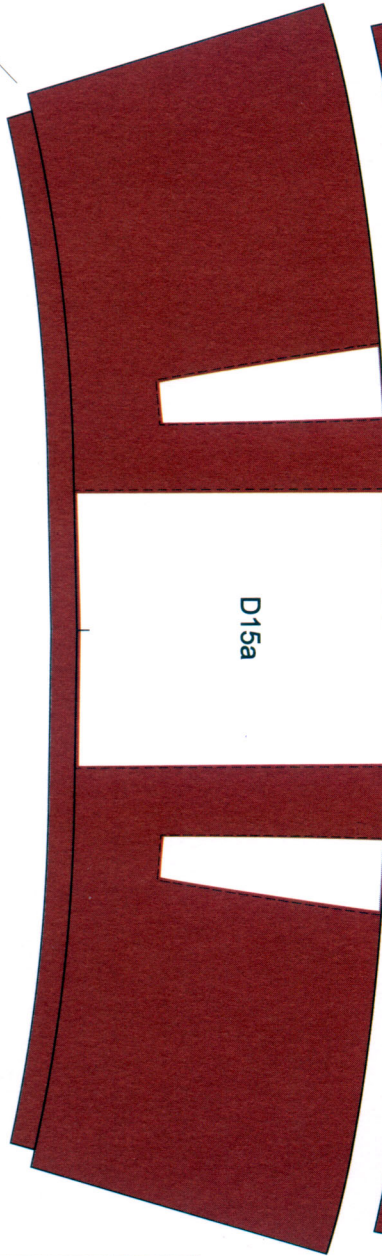
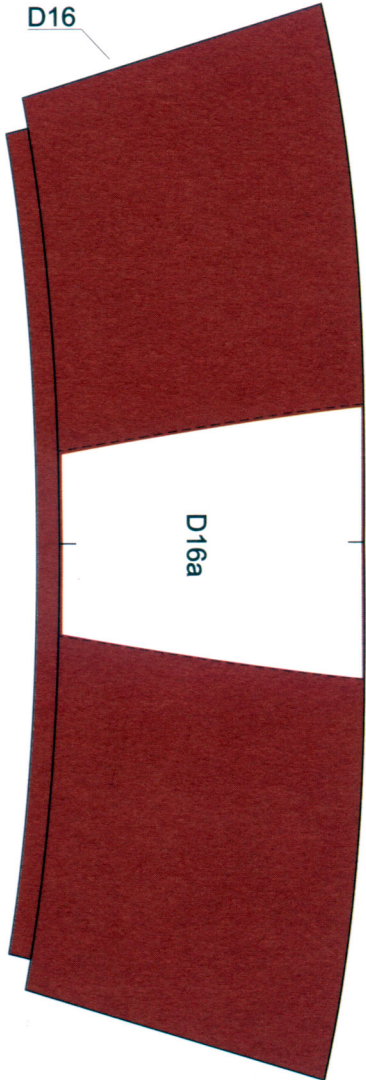
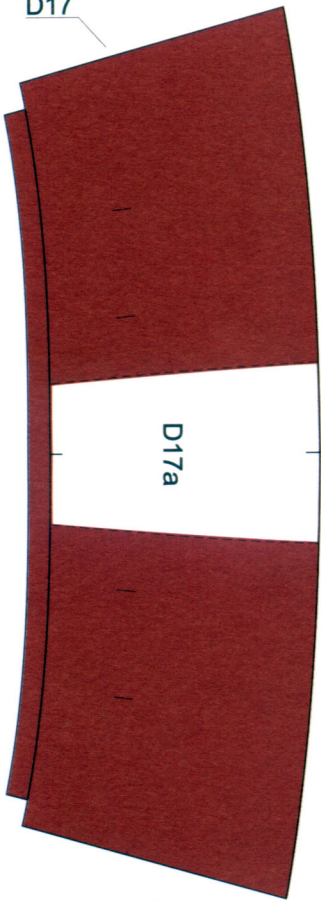

S6

S3

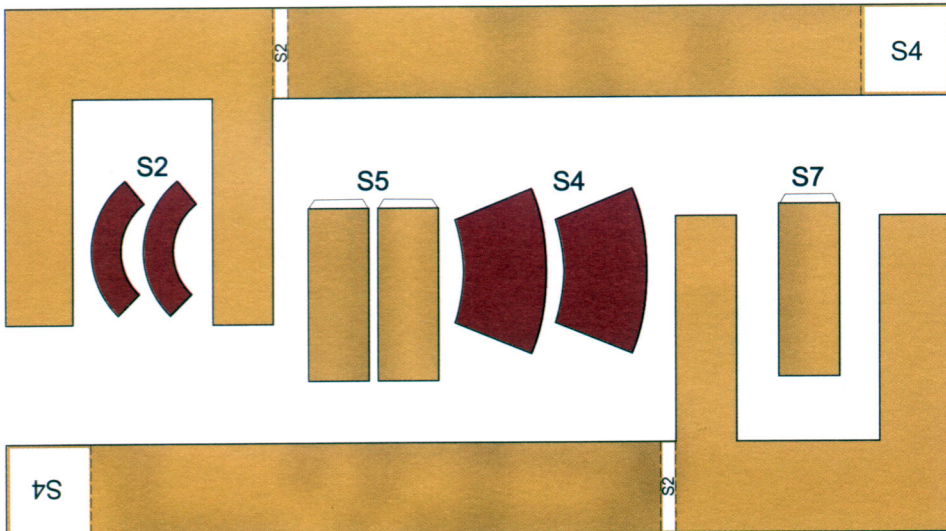

D18b

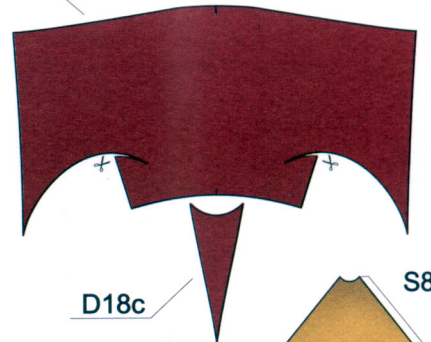

D18

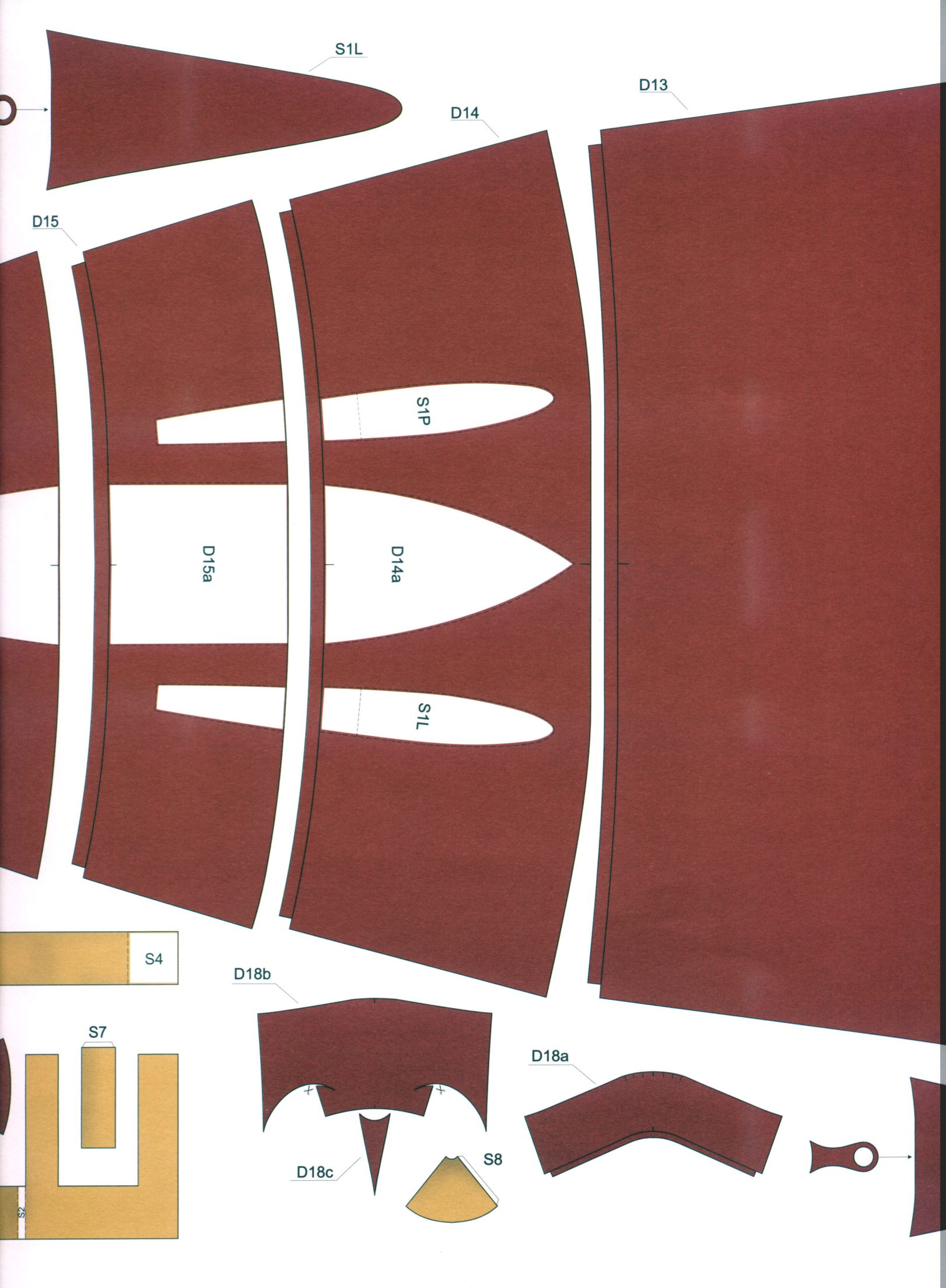



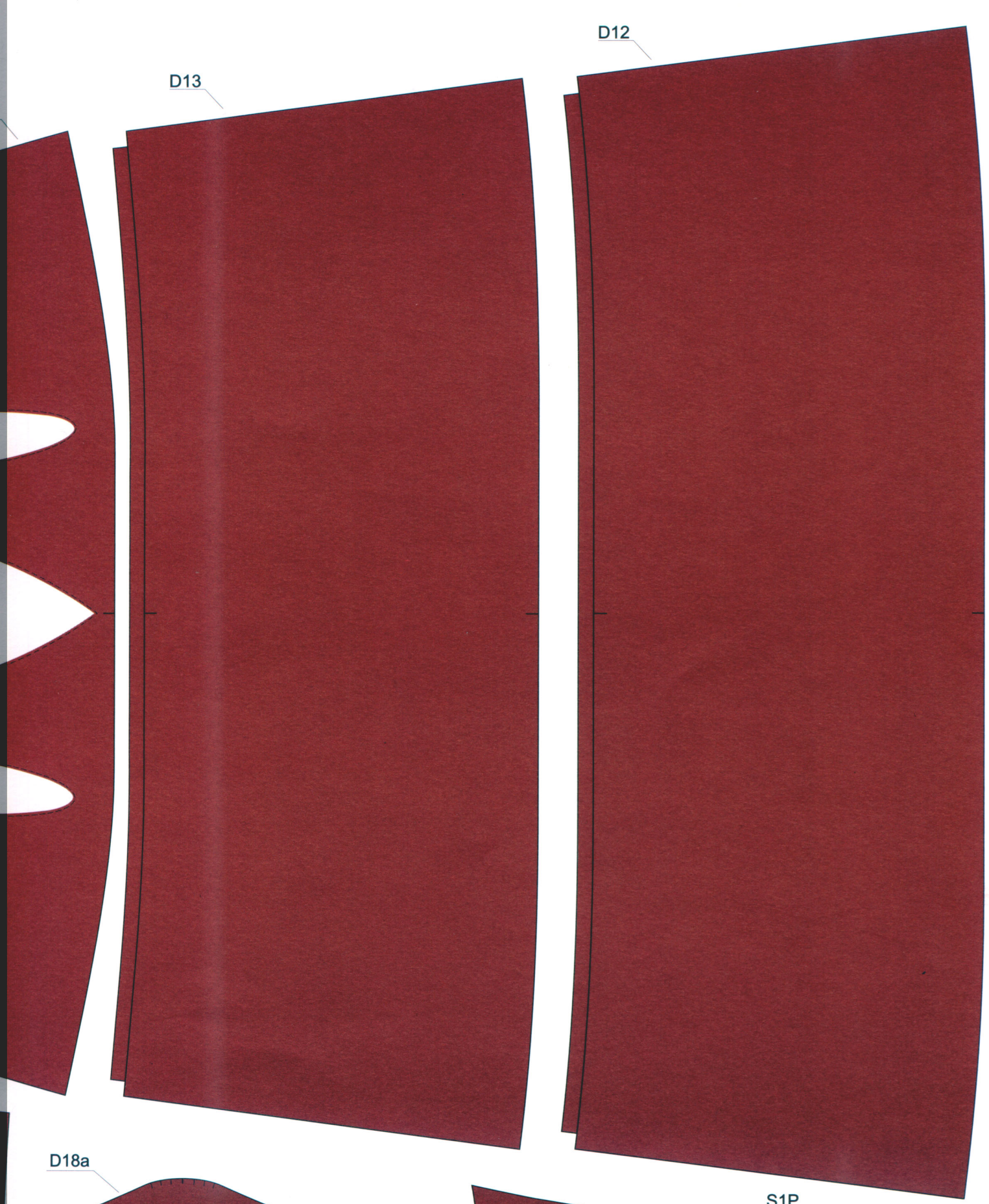

D13

D12

D18a

S8



S1P

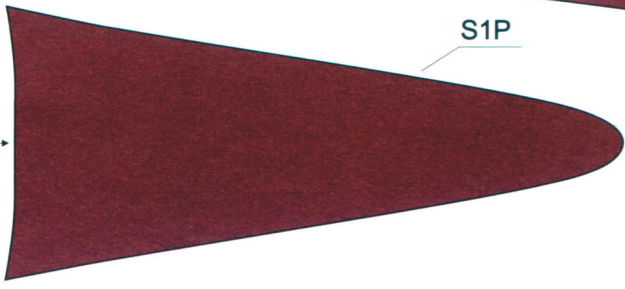

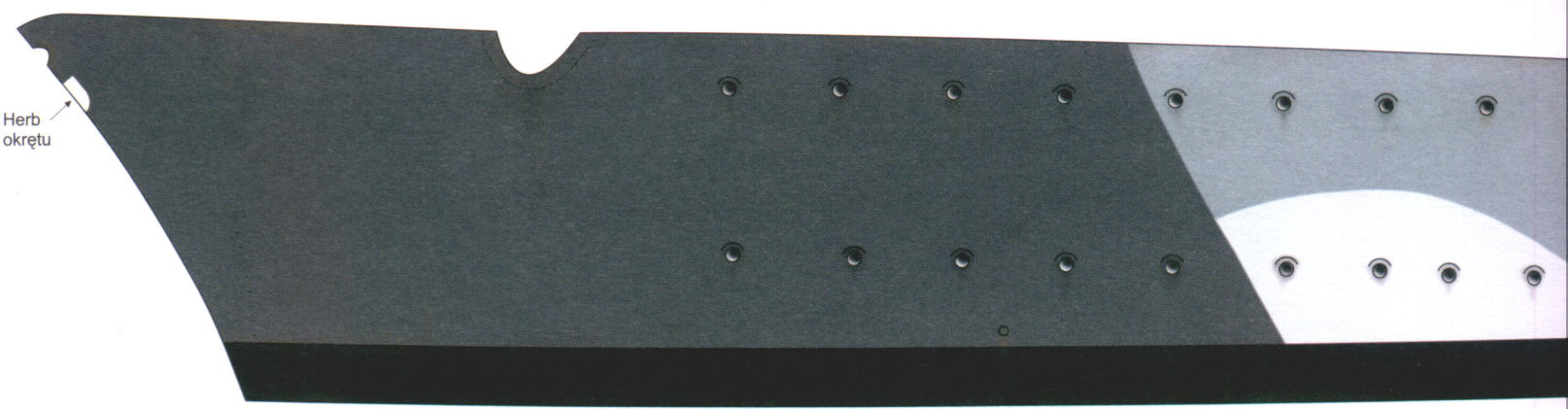
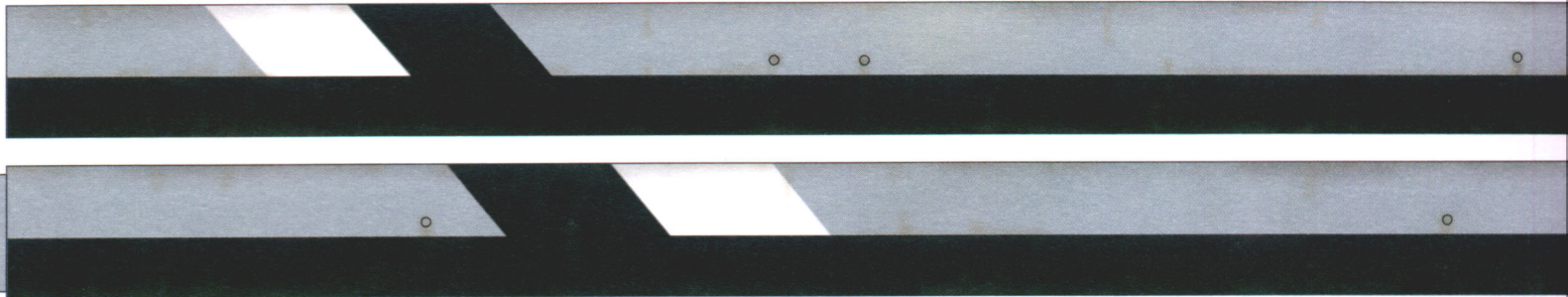
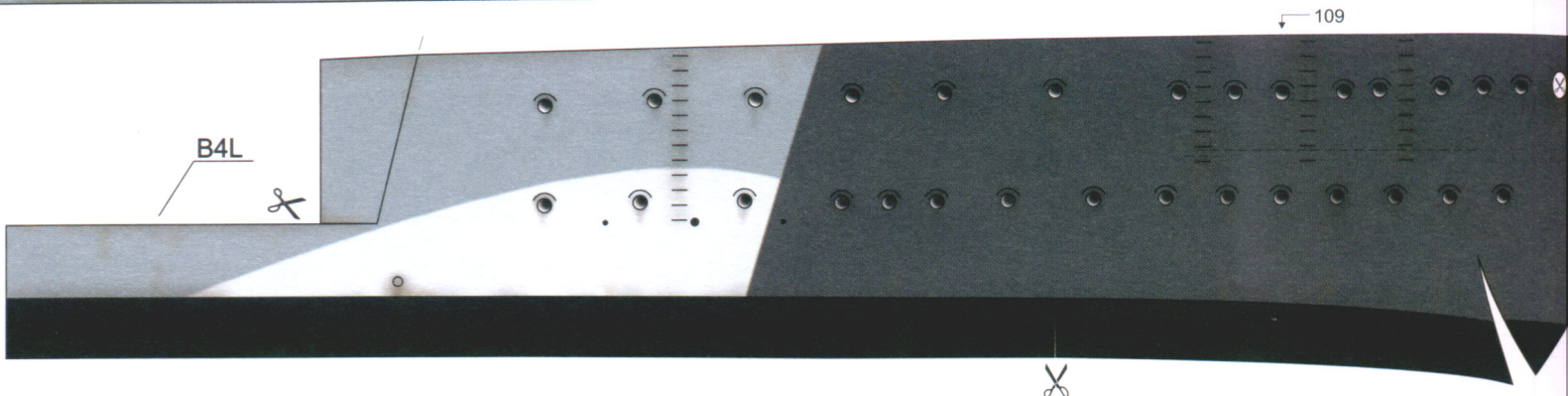
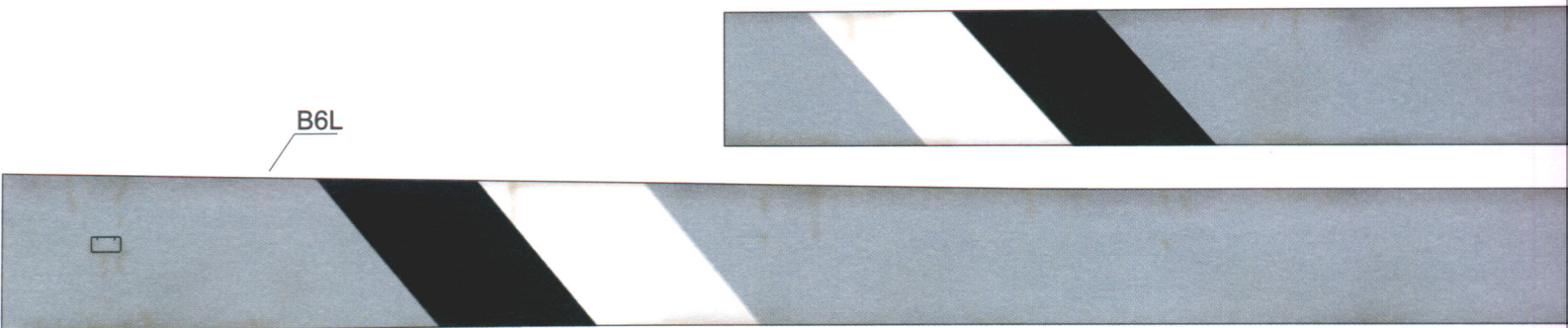
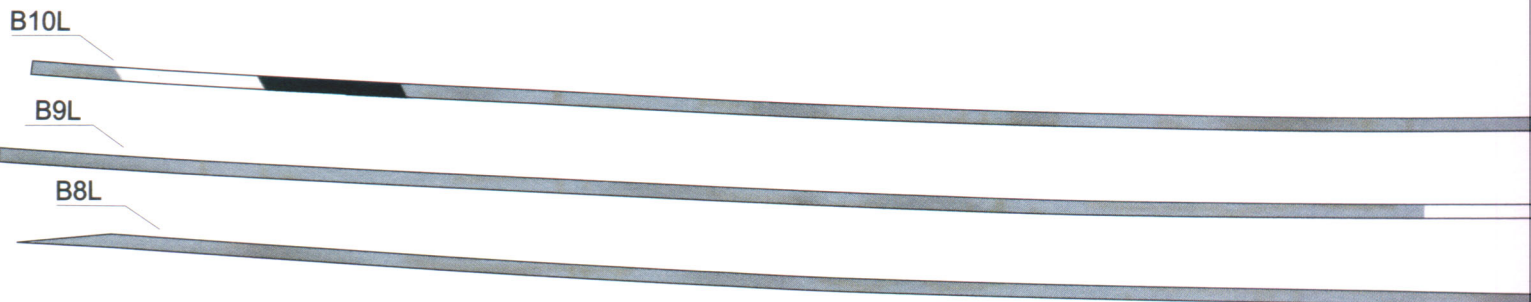
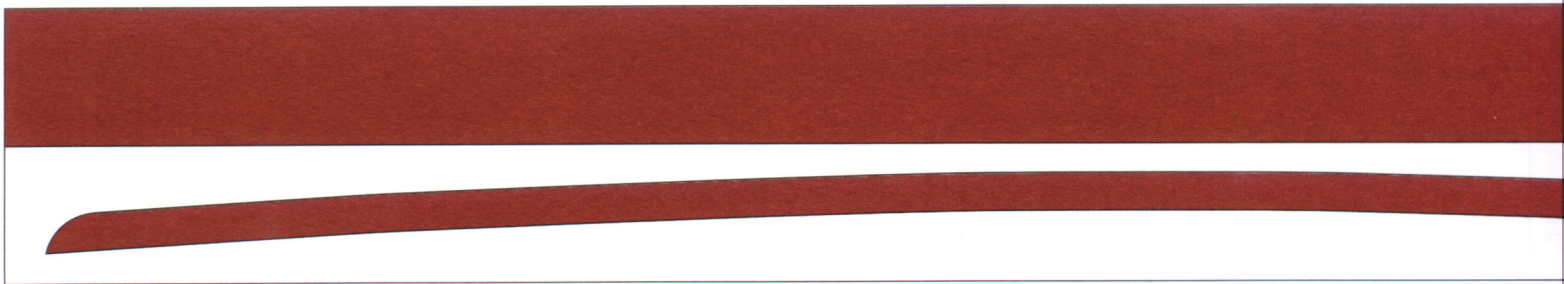

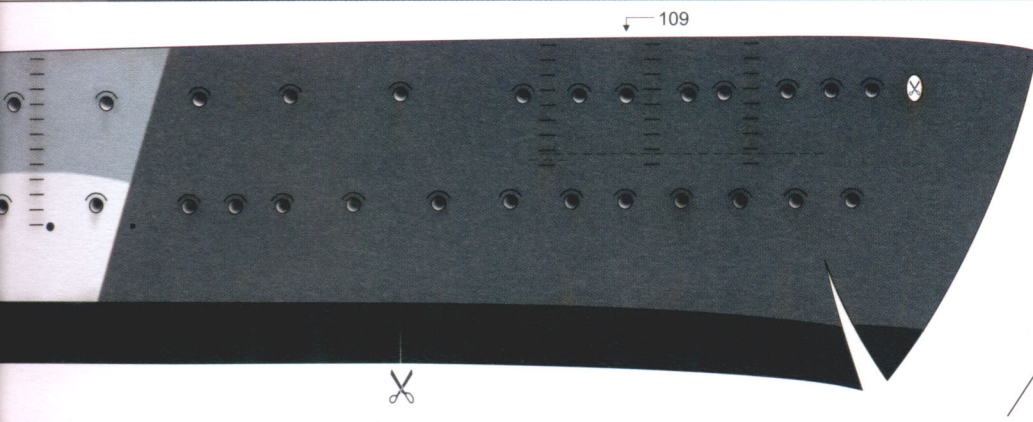
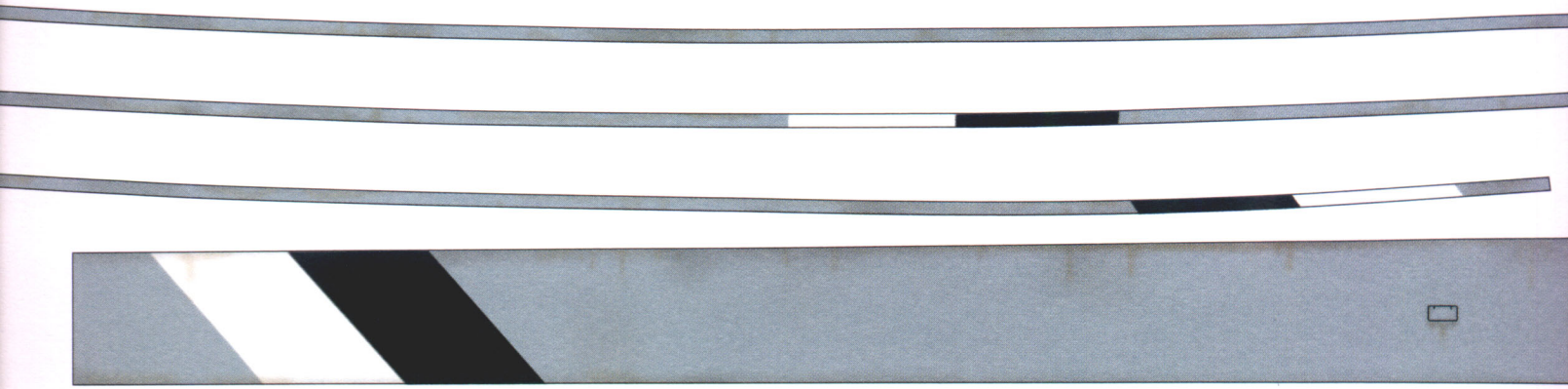
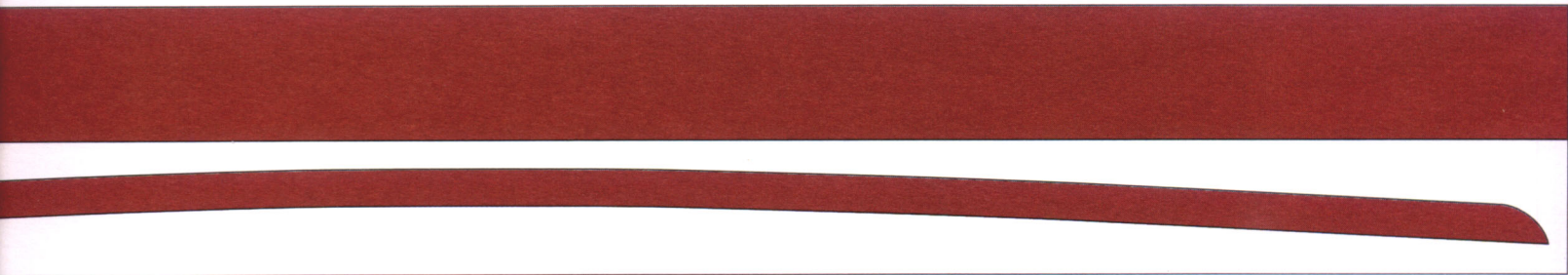

109

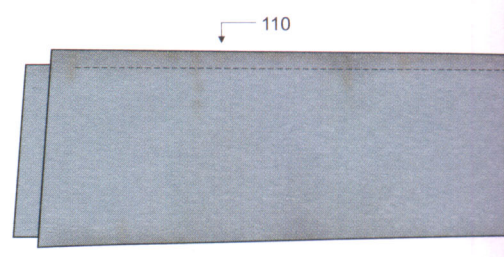

110

B3L

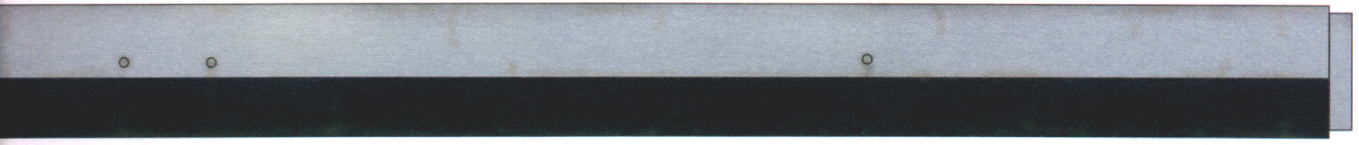

B2L

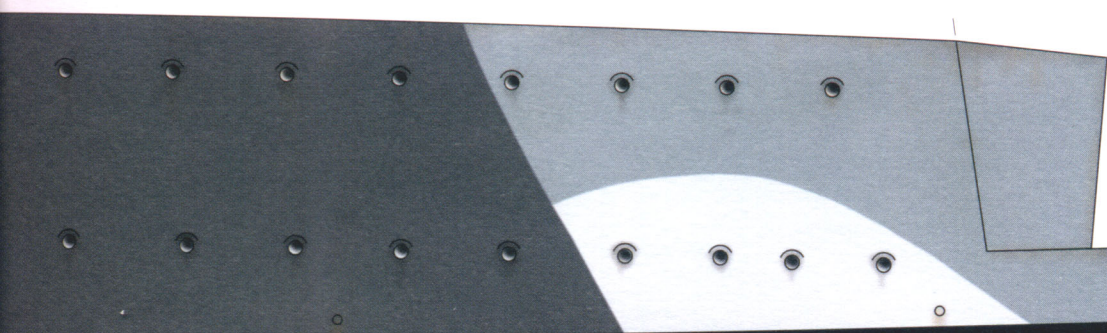
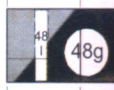

B1L

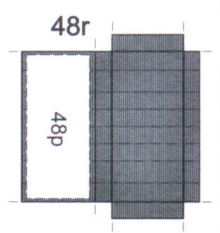

48r

48p

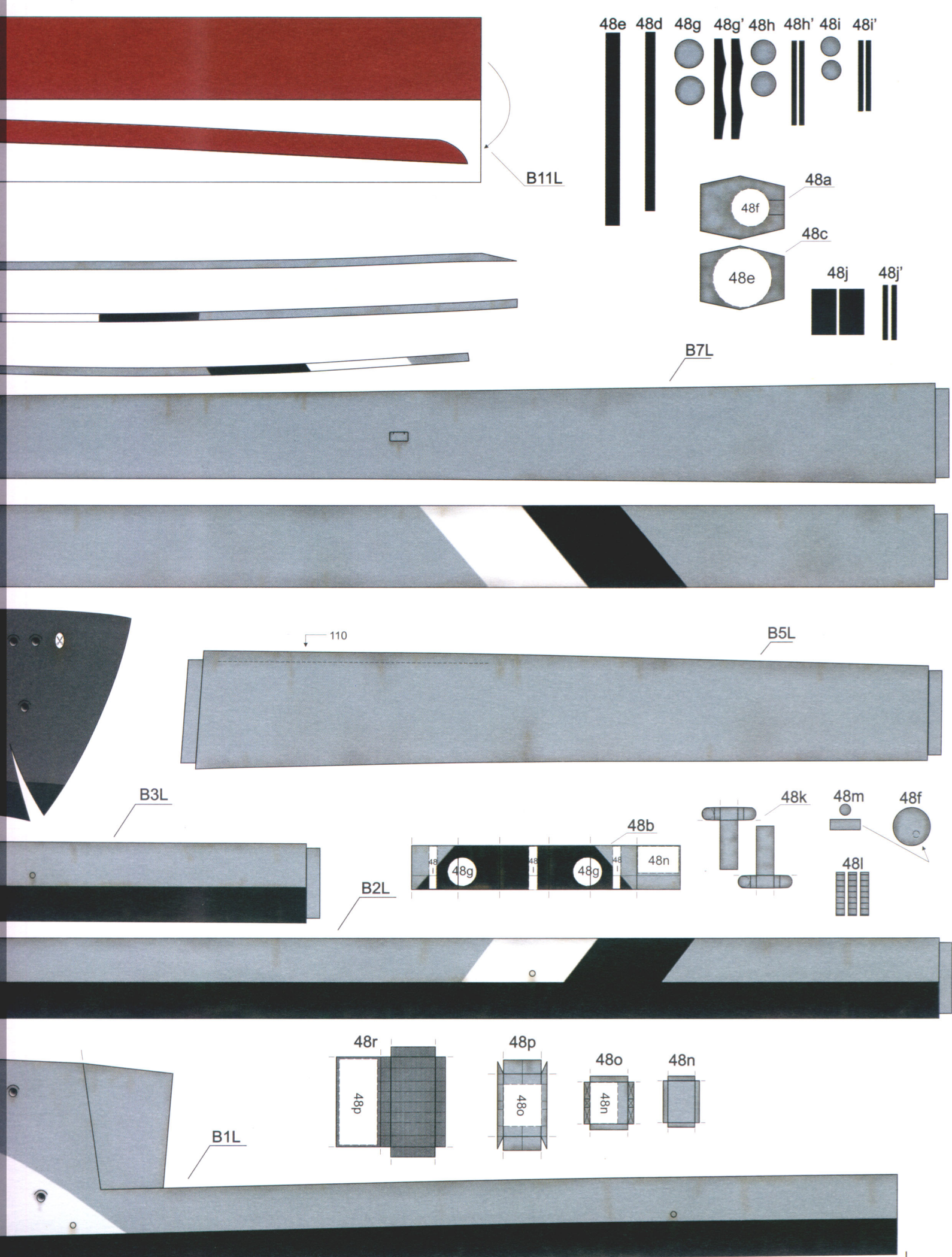

48e 48d 48g 48g' 48h 48h' 48i 48i'

B11L

48a

48c

48e

48j

48j'

B7L

110

B5L

B3L

B2L

48b

48k

48m

48f

48g 48g 48n

48l

48r

48p

48o

48n

48p

48o

48n

B1L

+

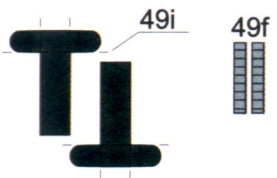
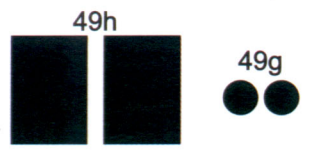
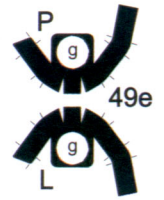
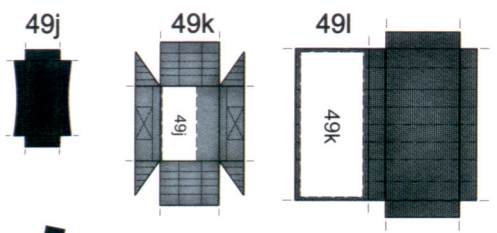

B7P

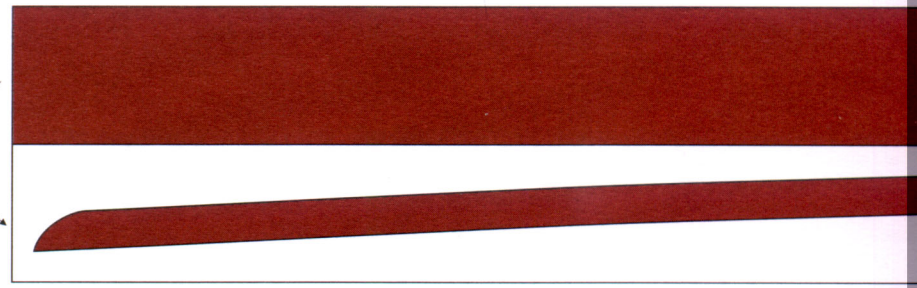

B11P

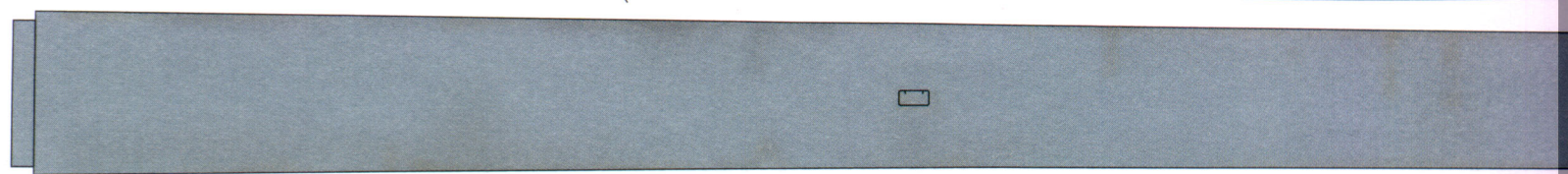
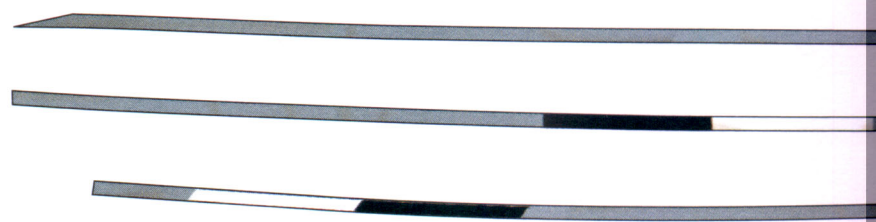

B5P

110

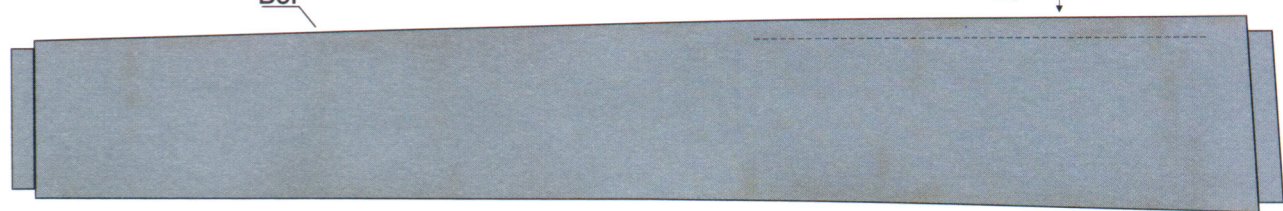

49b

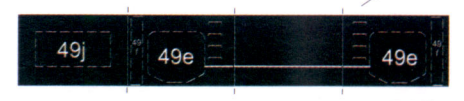
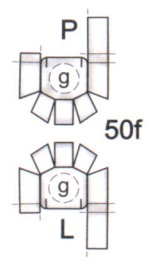
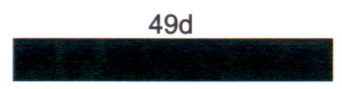
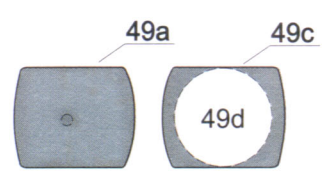

B3P

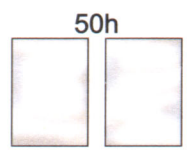
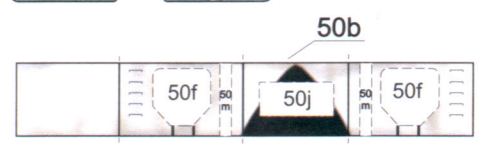

B2P

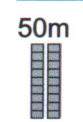
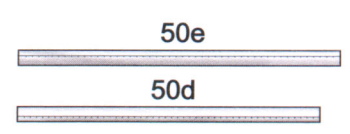
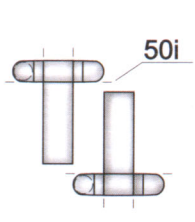
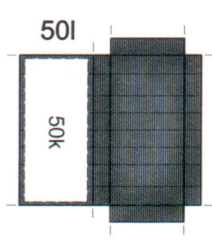
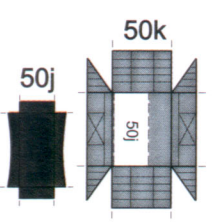
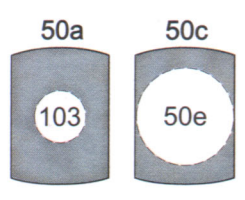

B1P

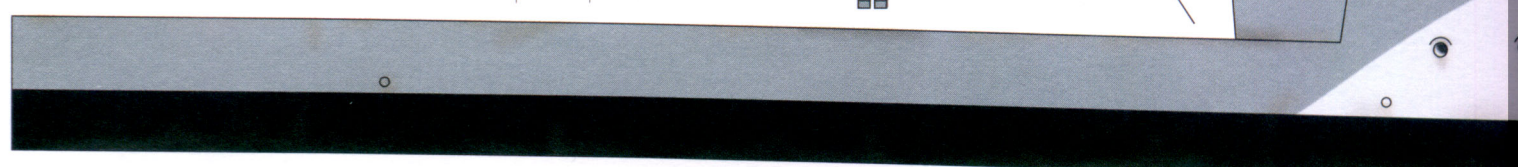

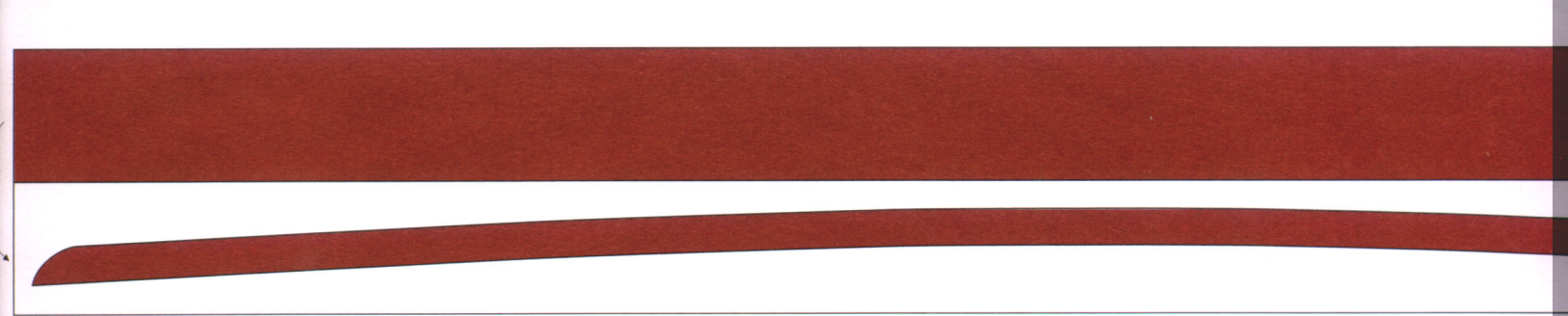

B11P

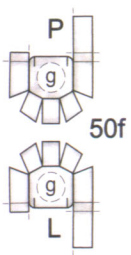
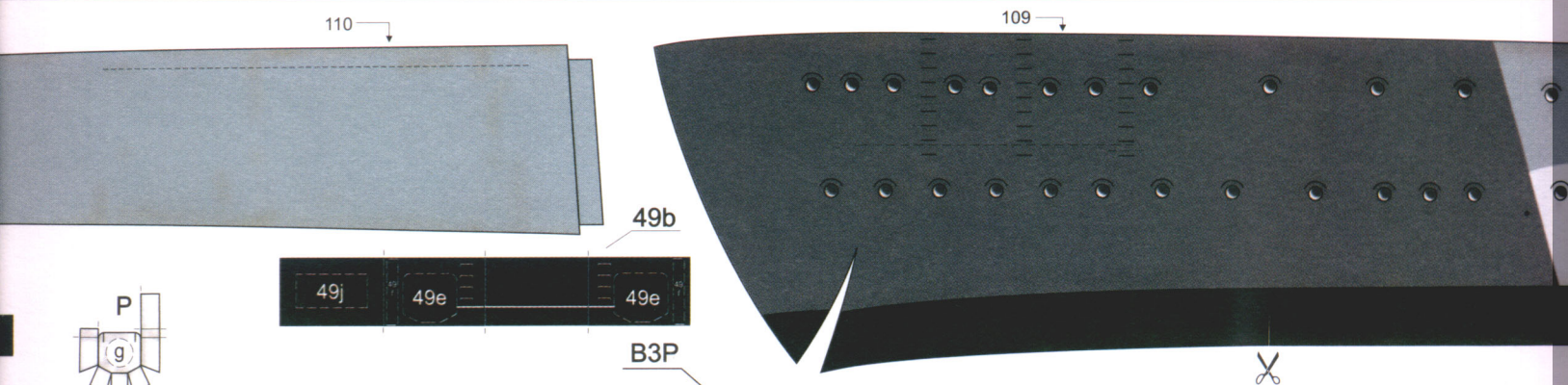
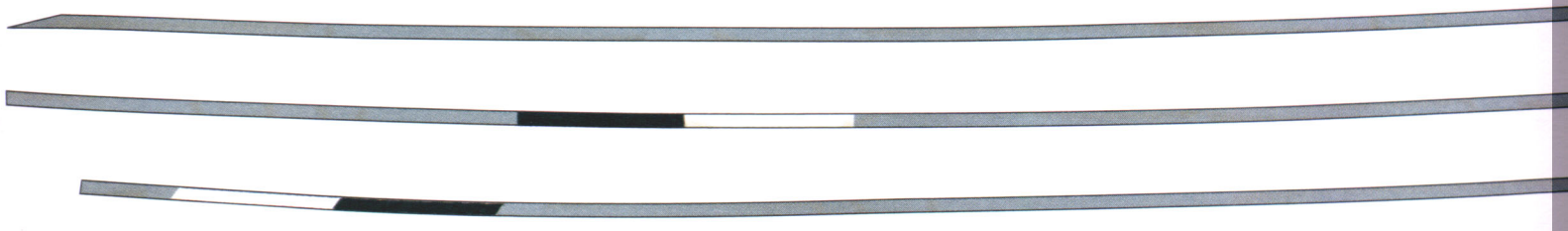

B2P

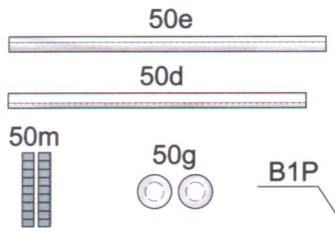
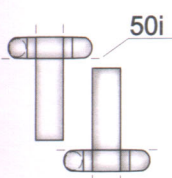
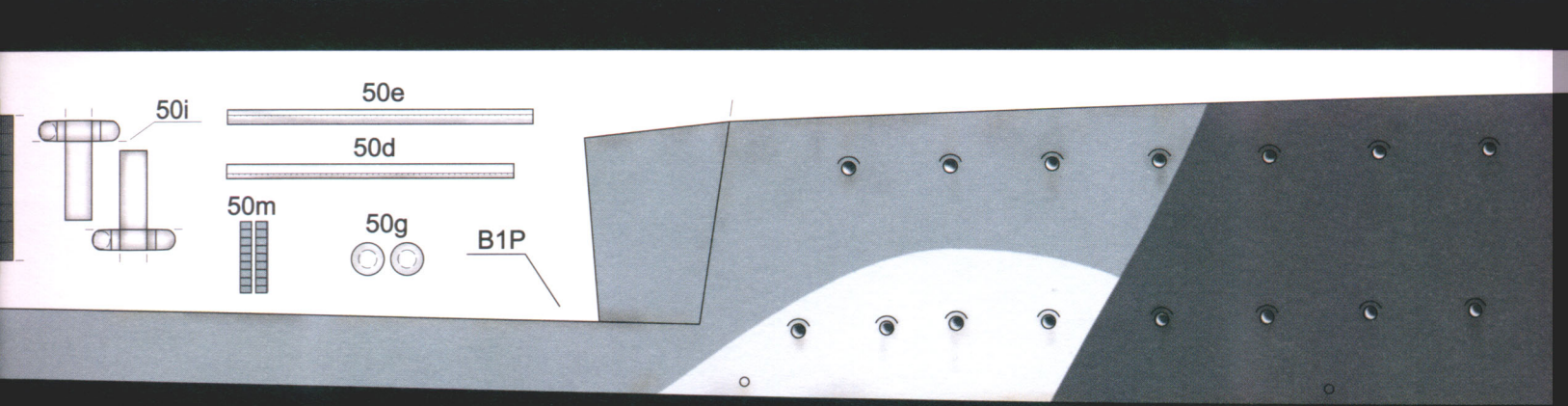

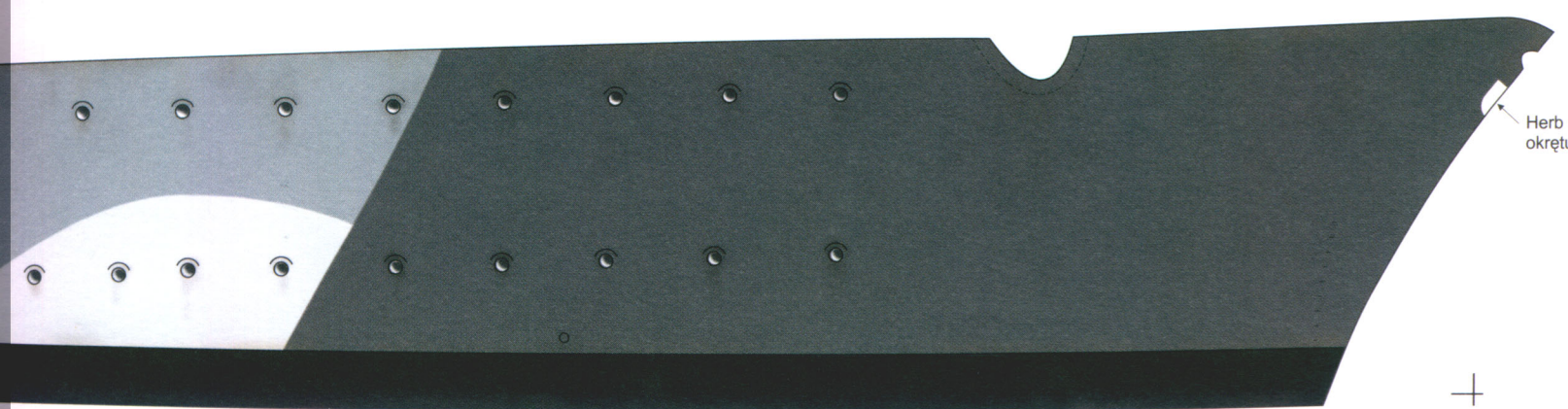
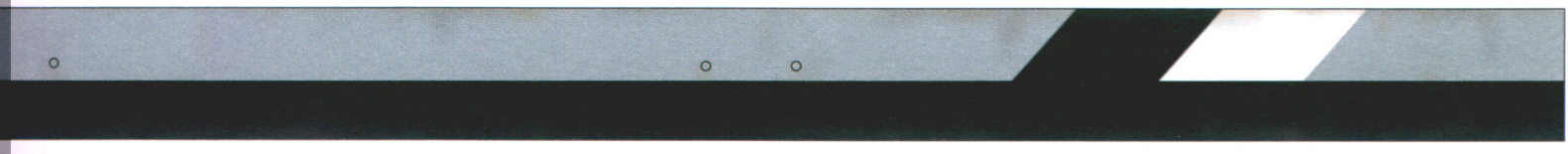
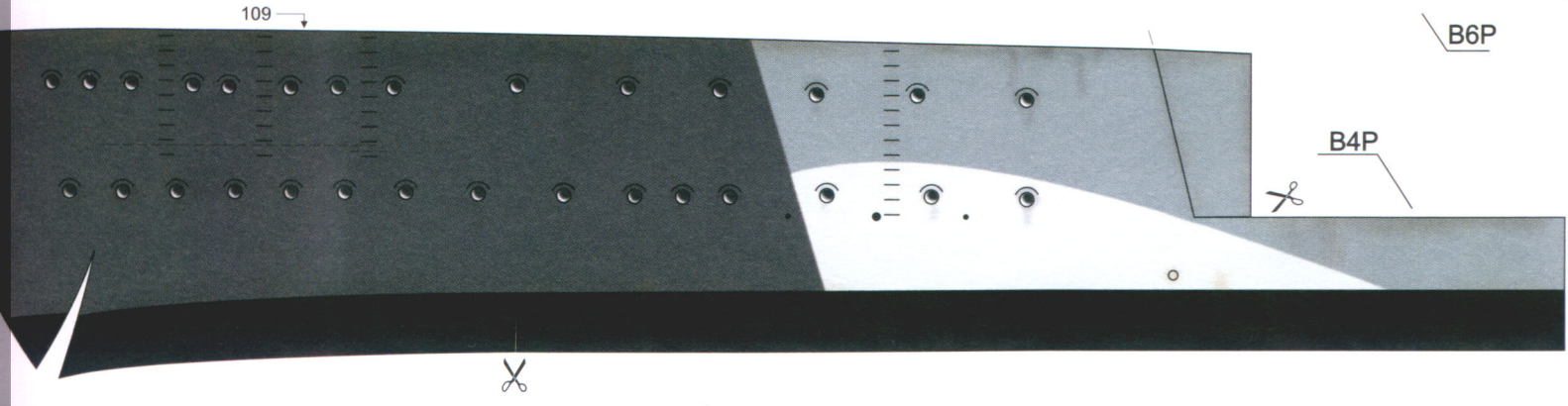
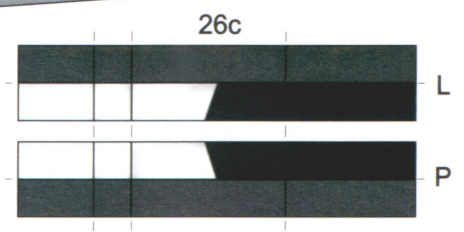
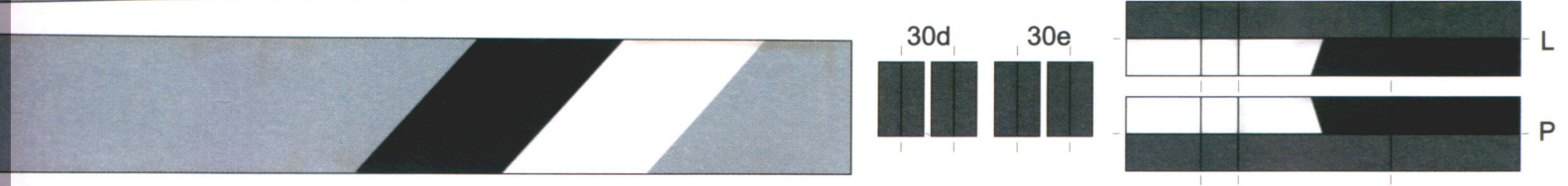
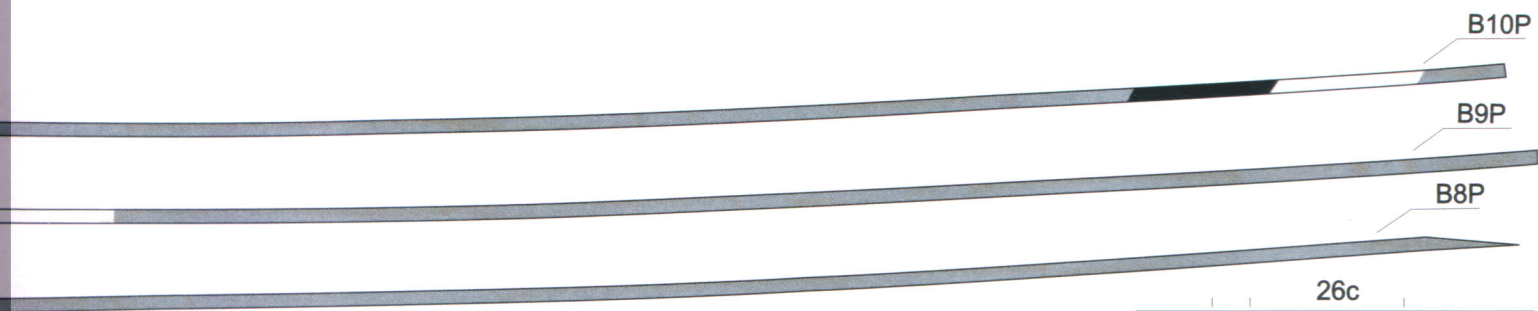
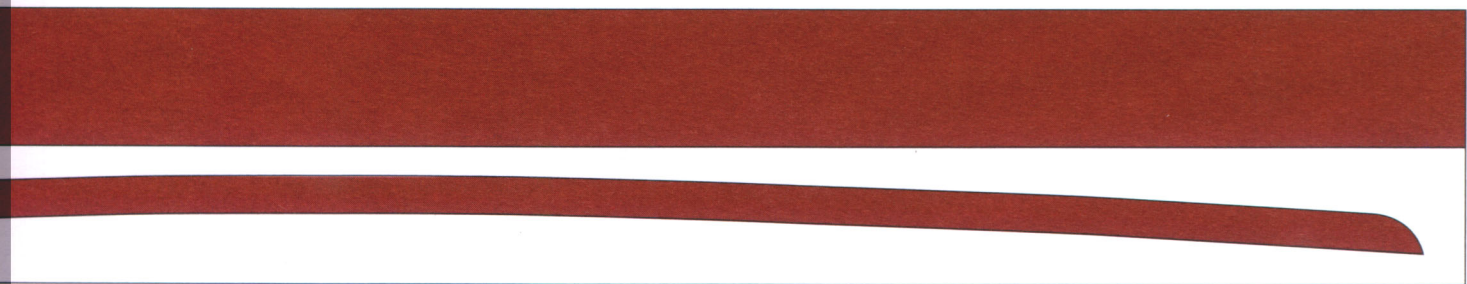







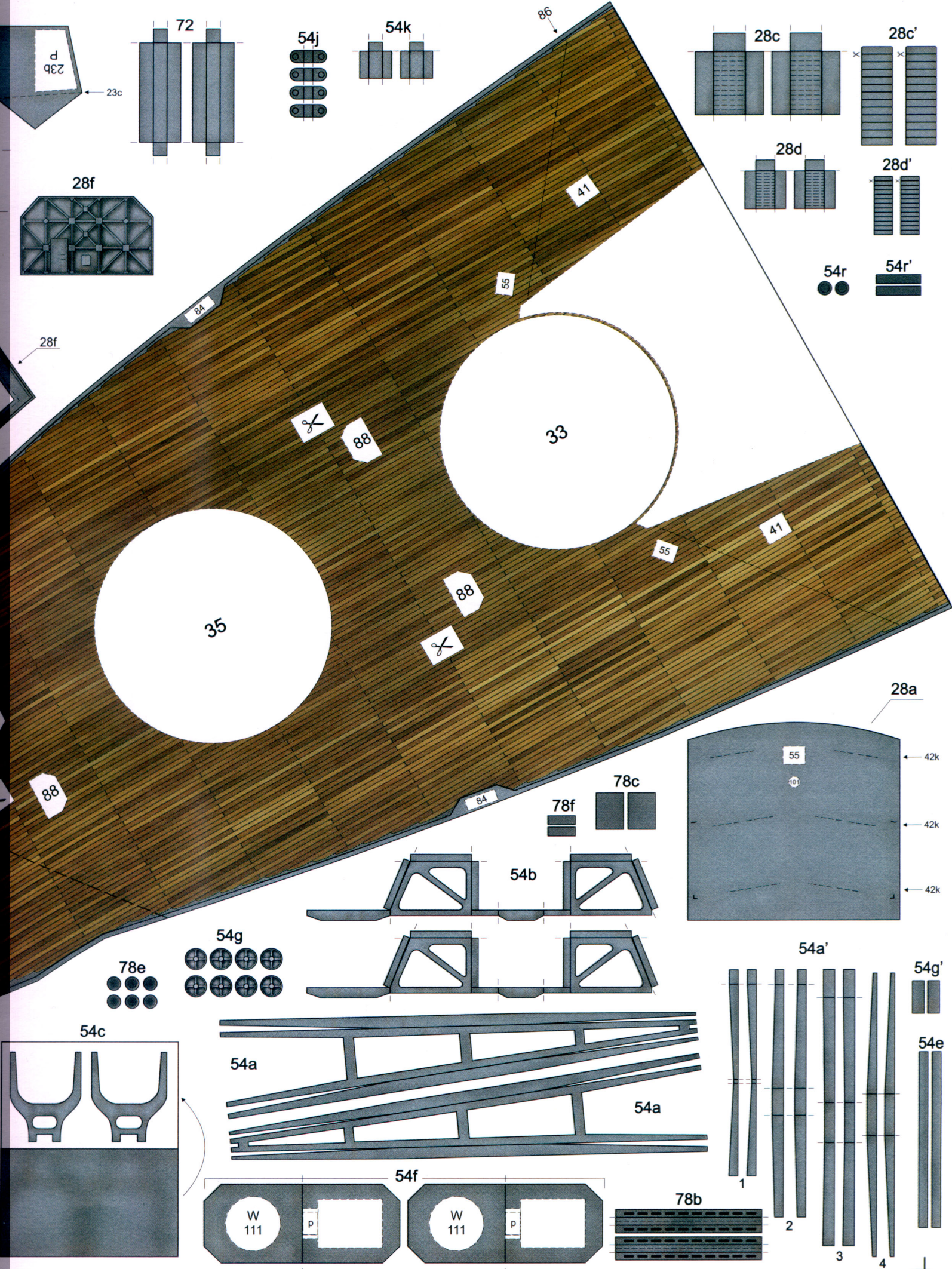

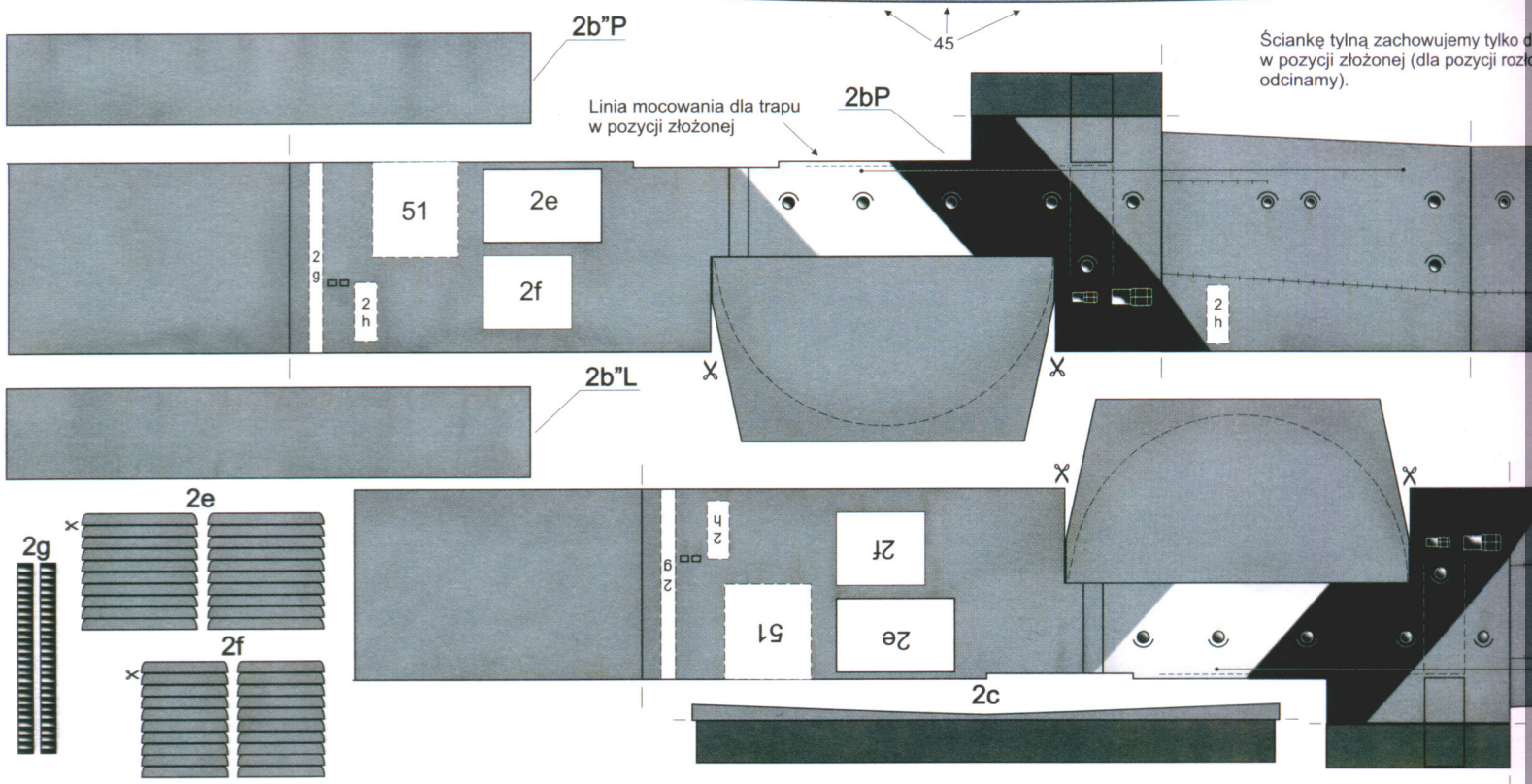
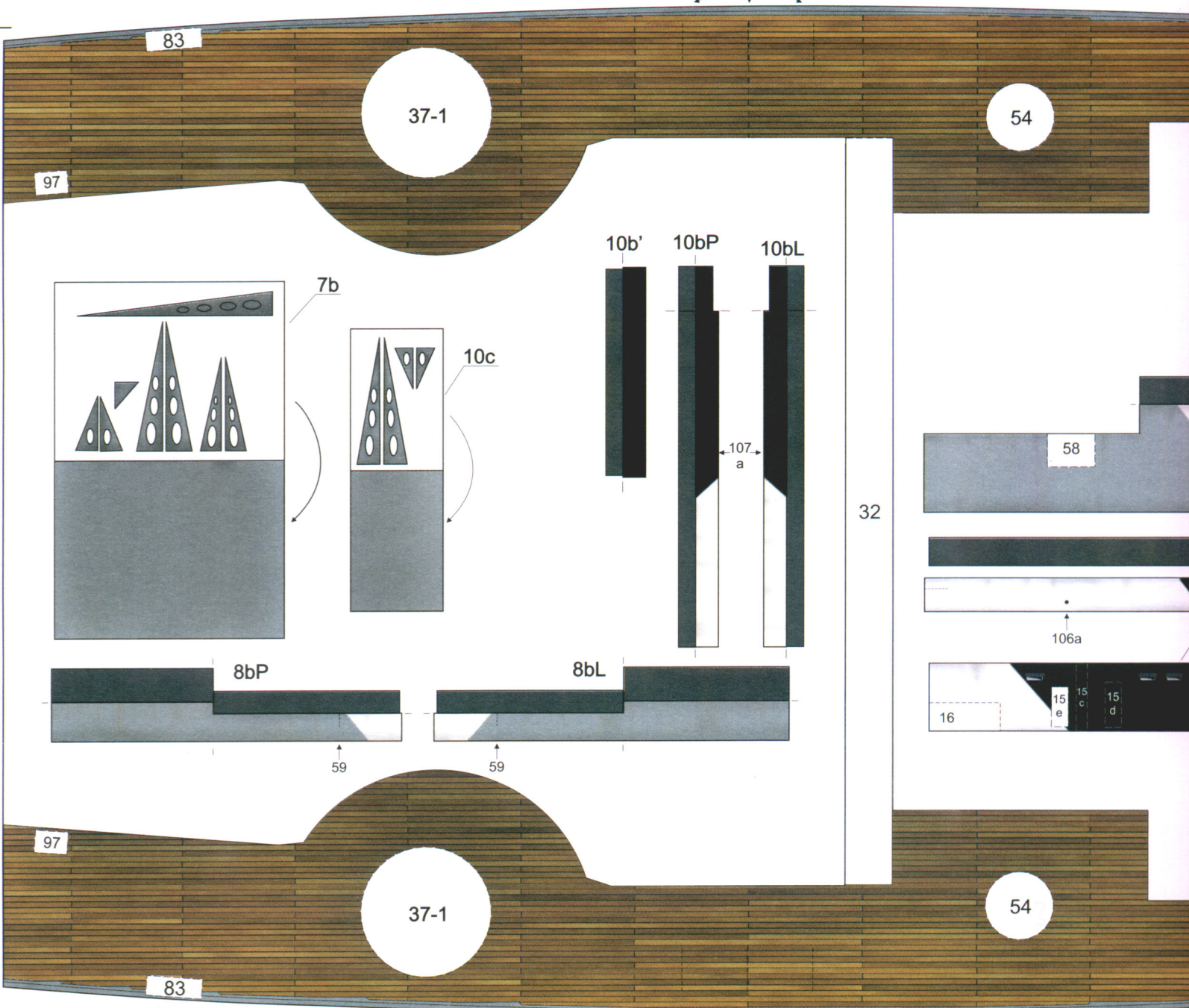

54

37-2

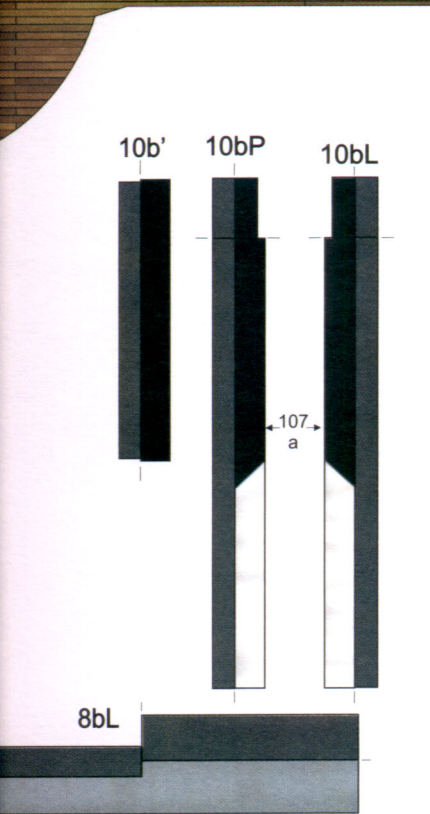

32

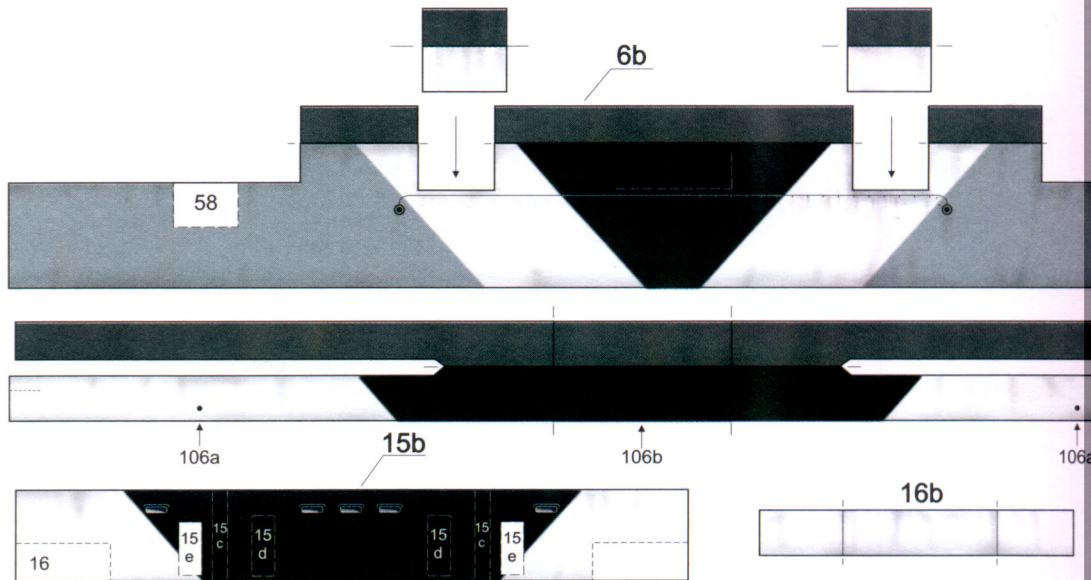

54

37-2

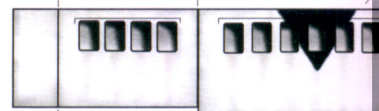
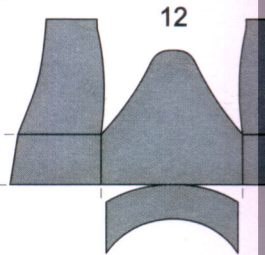
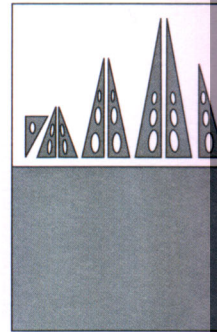
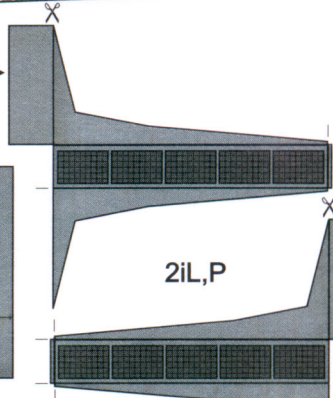
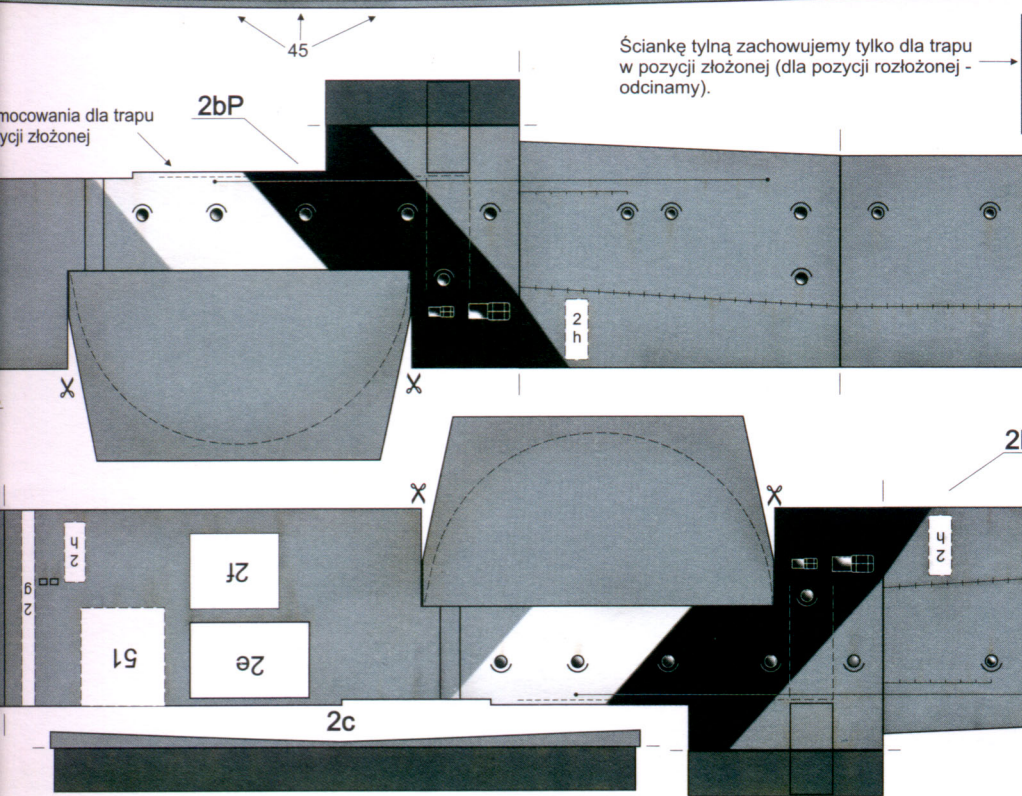

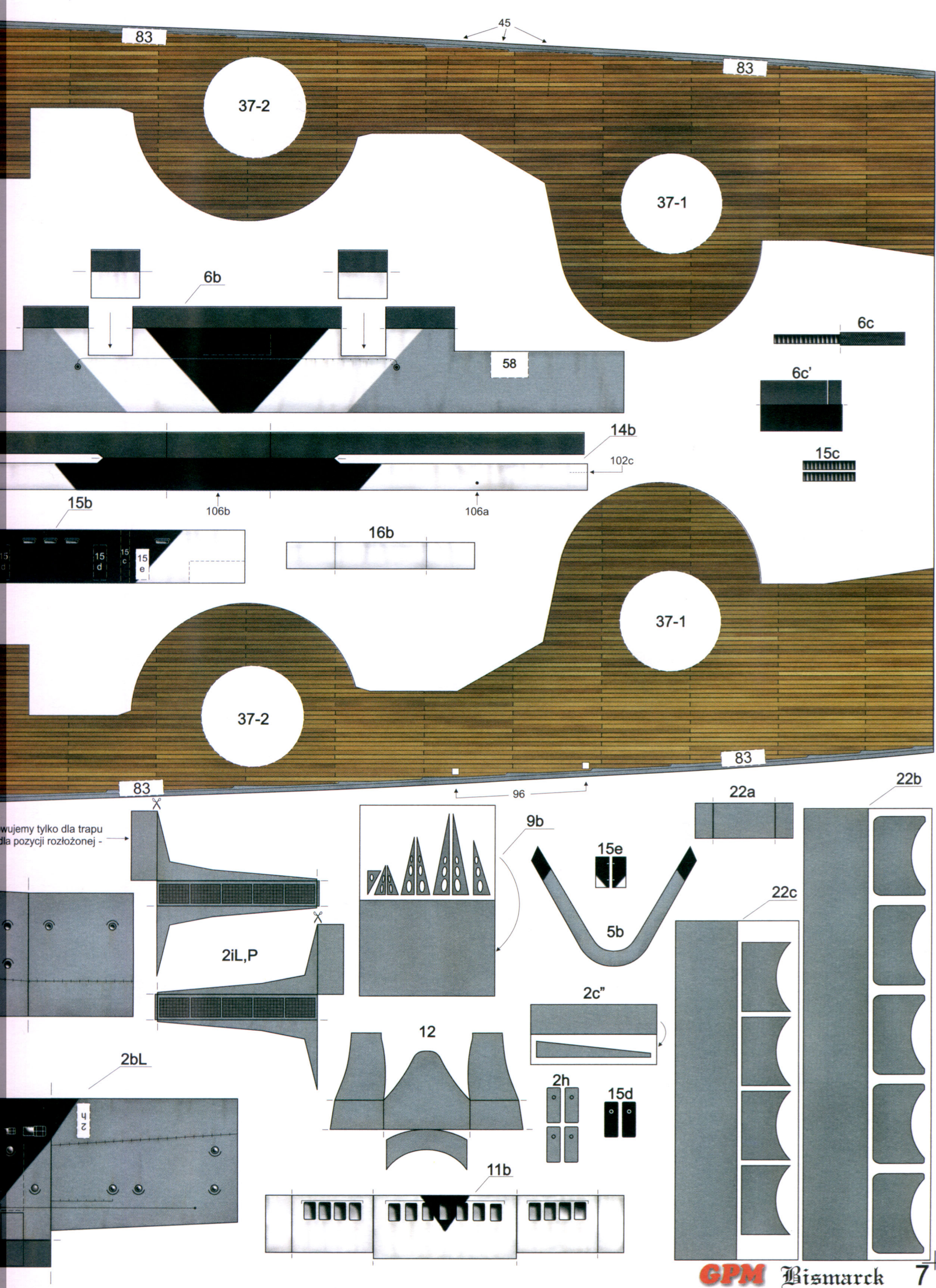

83

45

83

37-2

37-1

6b

58

6c

6c'

15c

14b

102c

15b

106b

106a

16b

37-1

37-2

83

83

96

22b

22a

wujemy tylko dla trapu dla pozycji rozłożonej -

2iL,P

2bL

12

9b

15e

5b

22c

2c''

2h

15d

11b



42f

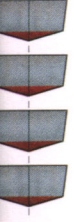

42e

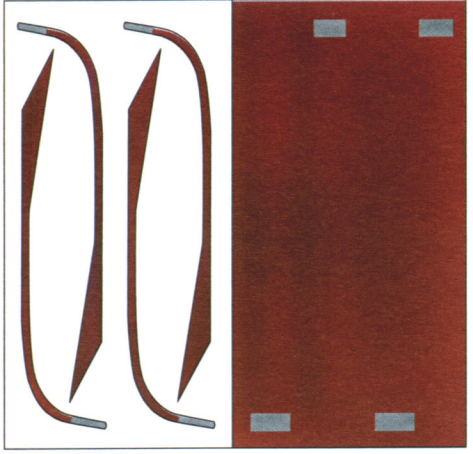

42g



42c

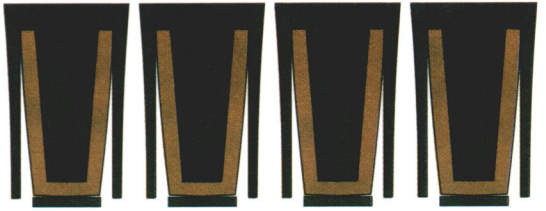

45c

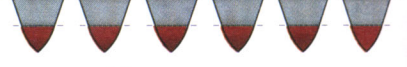

44c



44g



43a

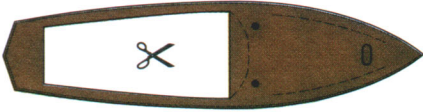

43c

lekko zagiąć

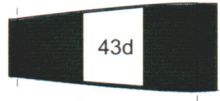

44f

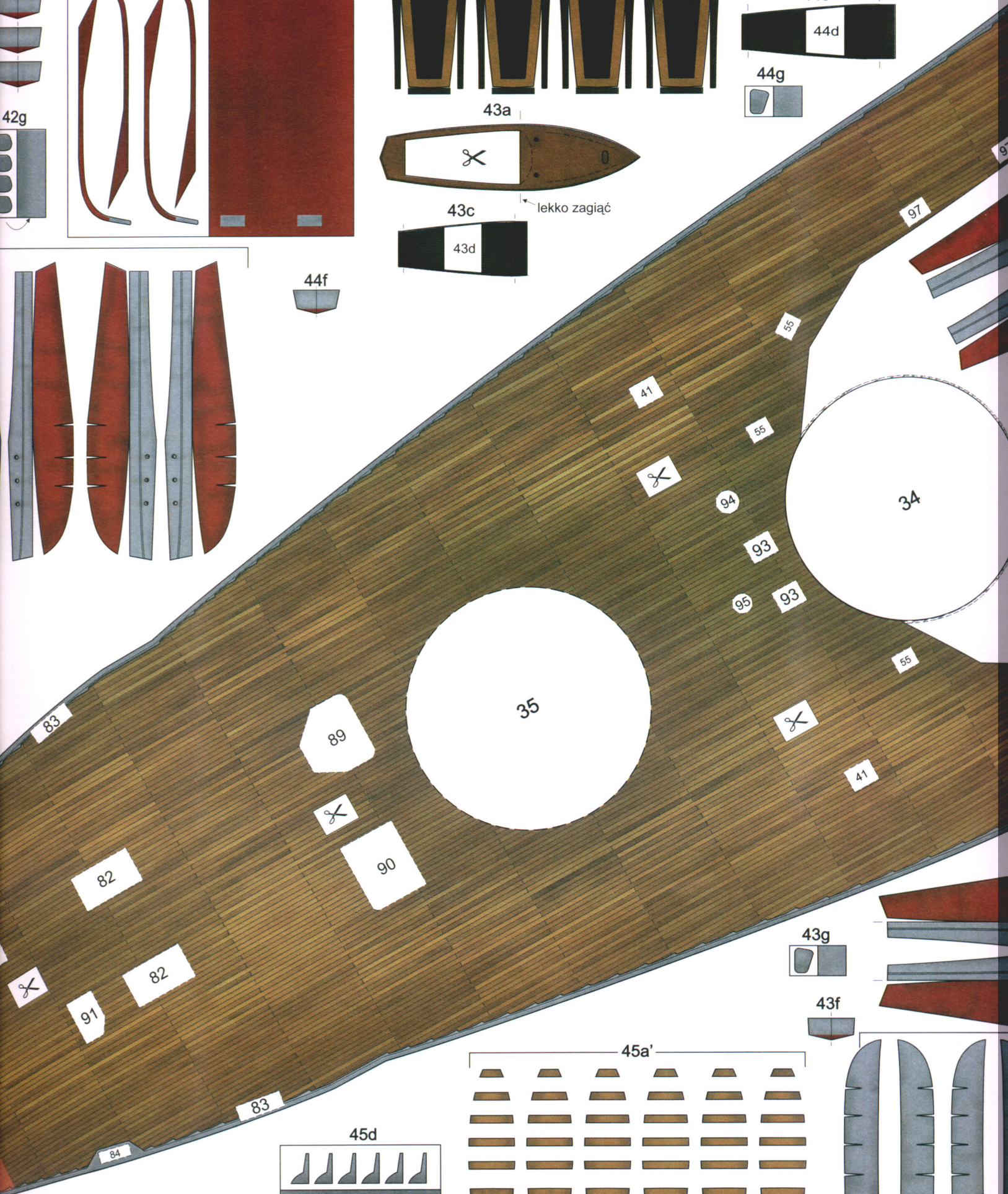
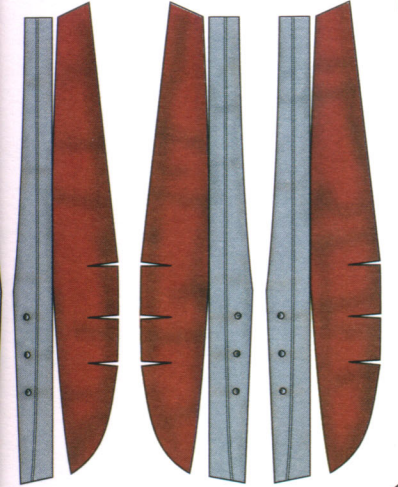

43g



43f



45a'

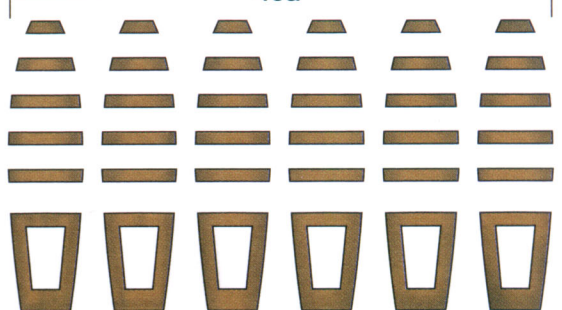

45d

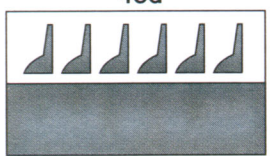

L P L

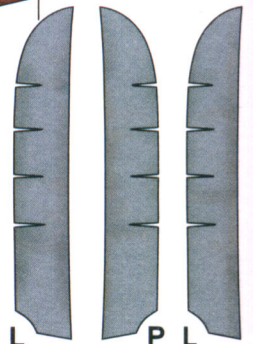





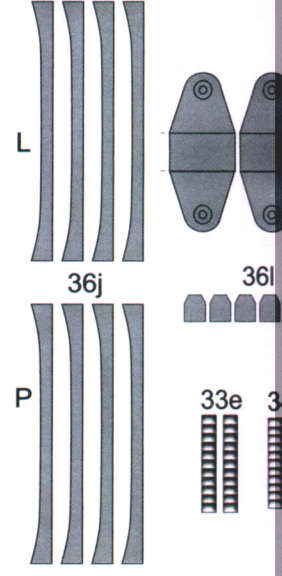
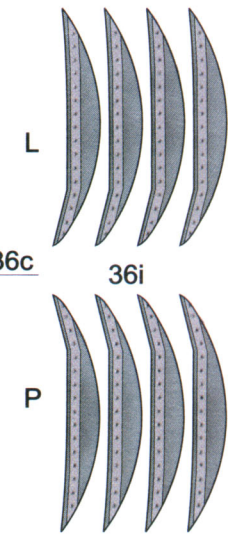
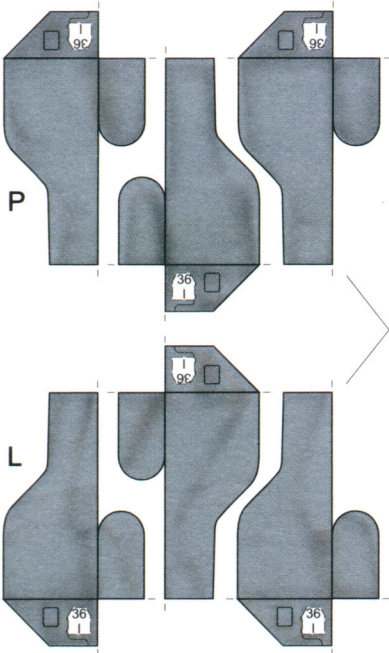
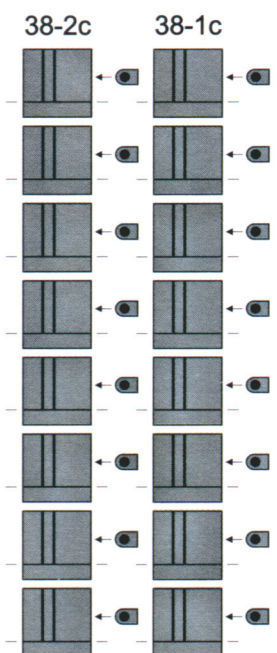
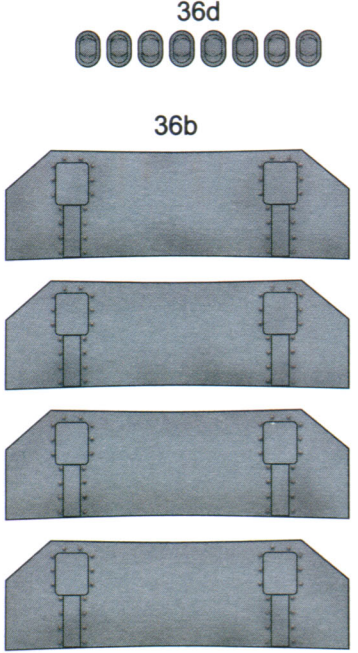
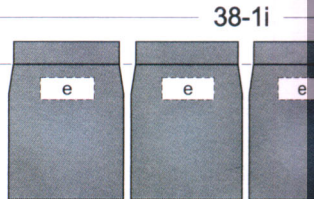
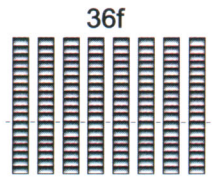
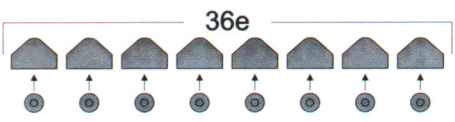
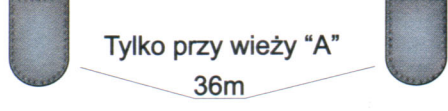
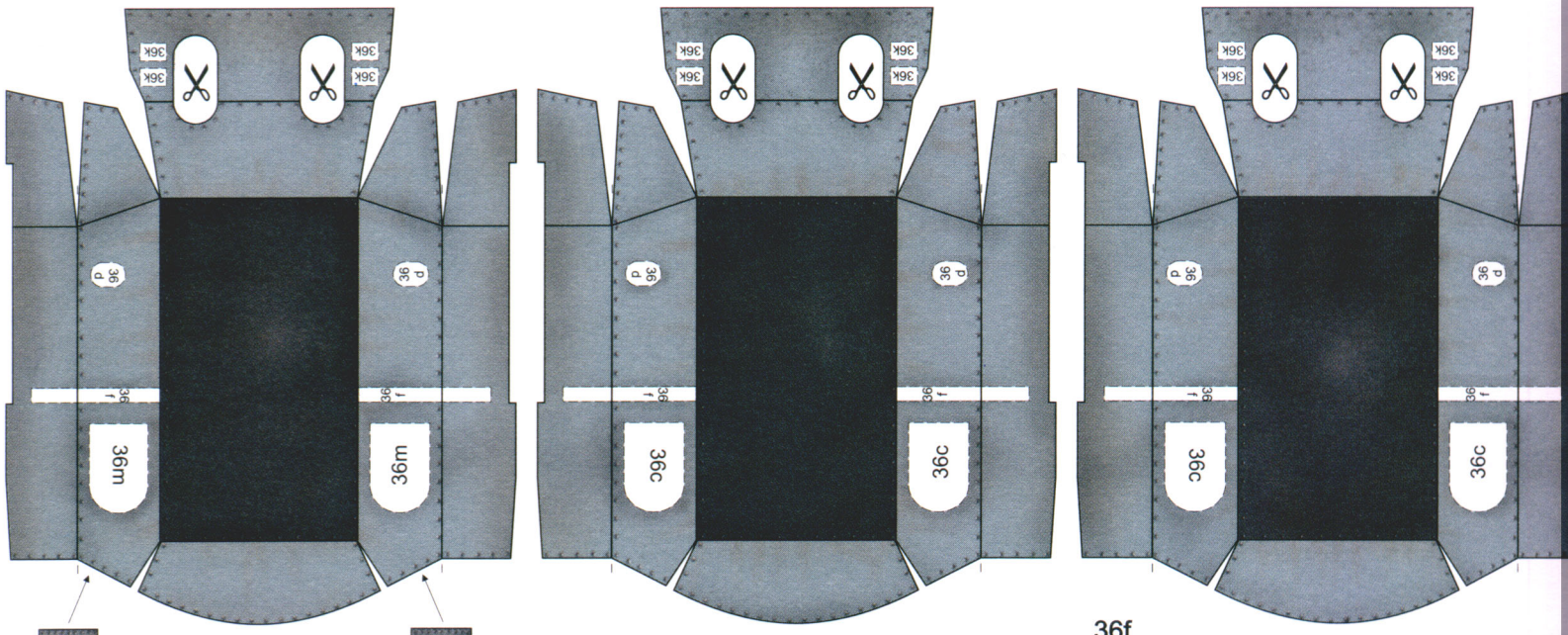
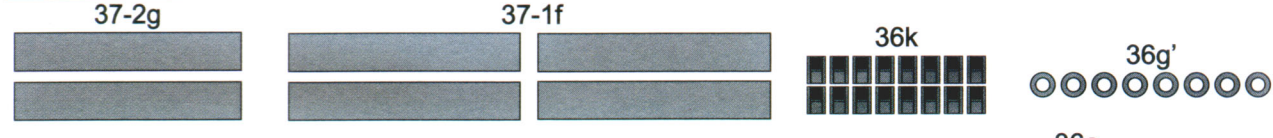
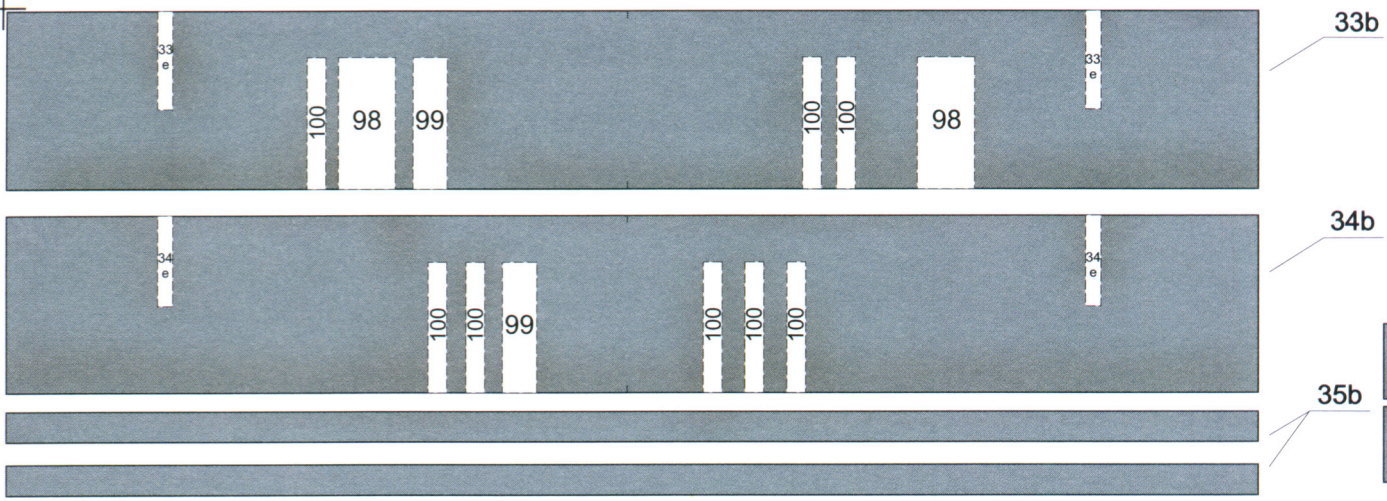

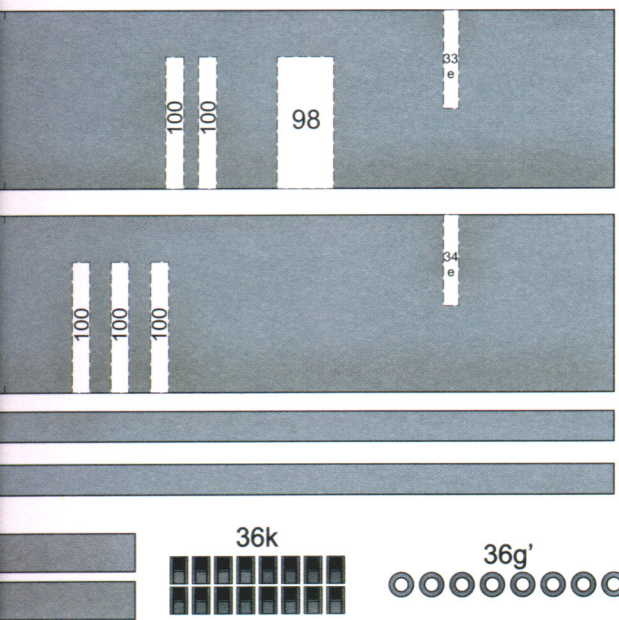

33b

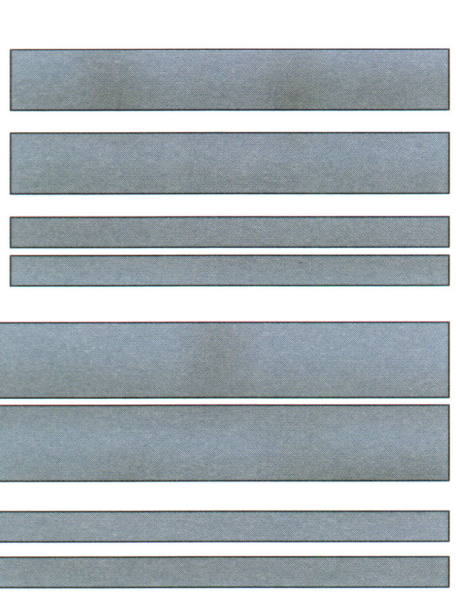

33f

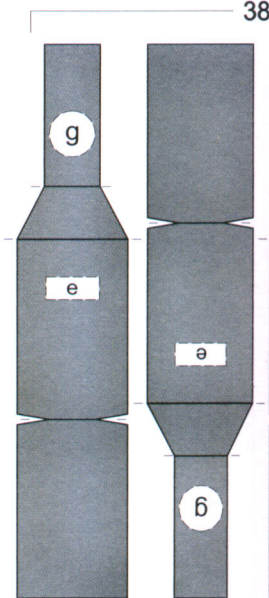

38-2f



36a

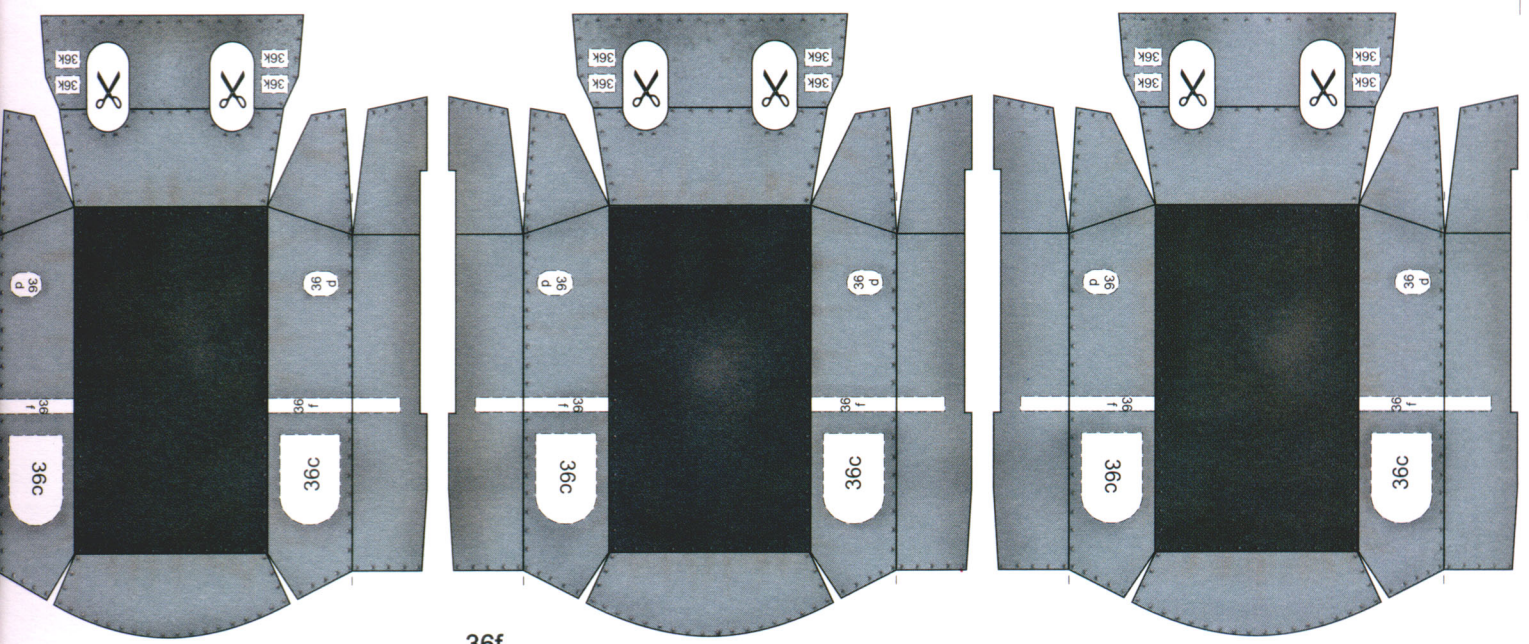

36f

38-1i

38-2g

38-1g

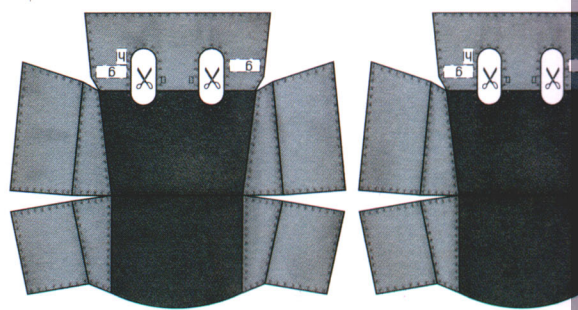
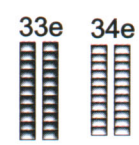
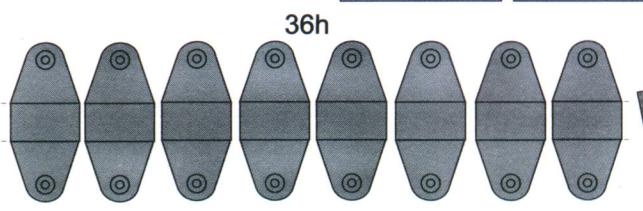
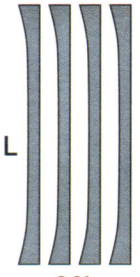
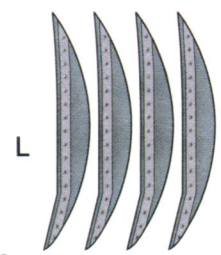
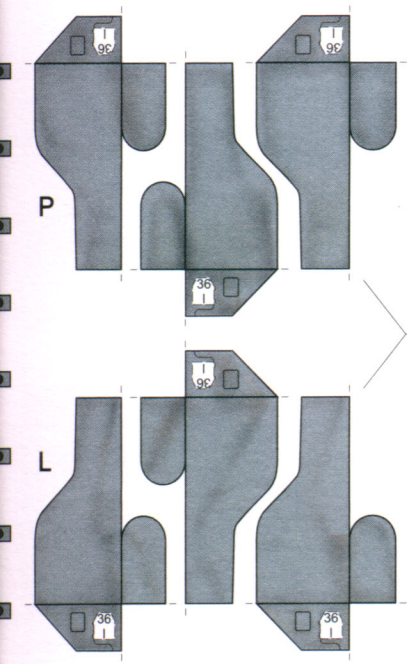
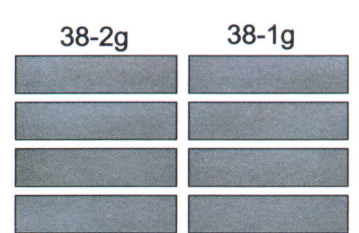
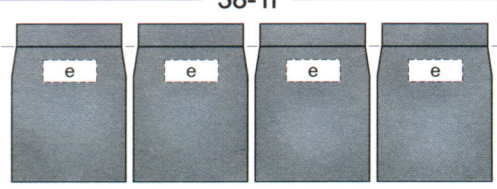
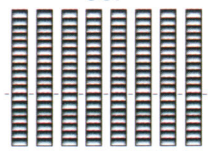
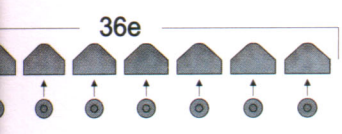

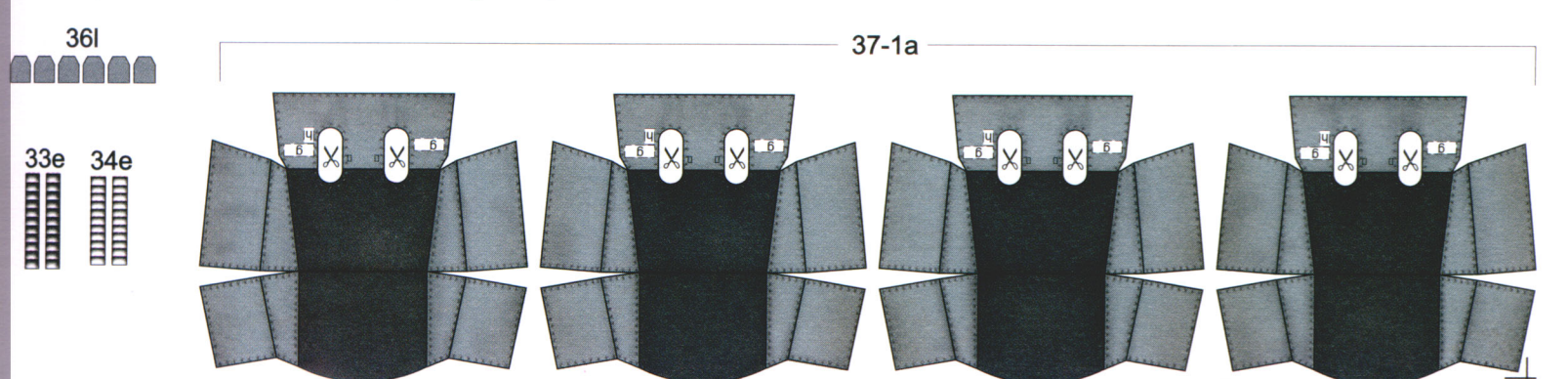
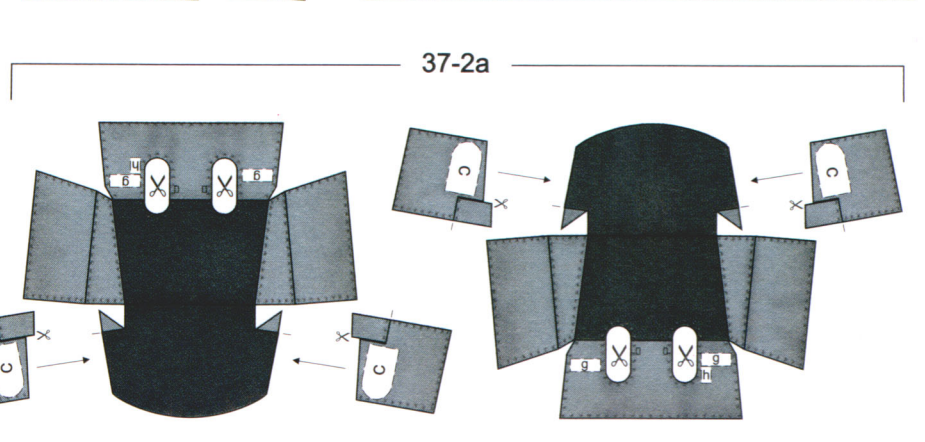
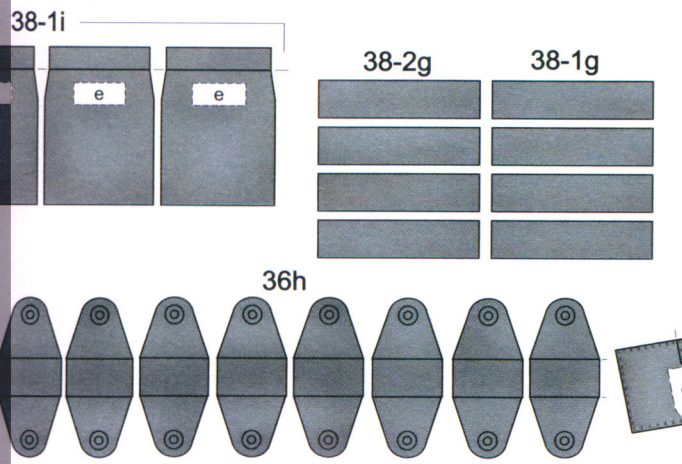
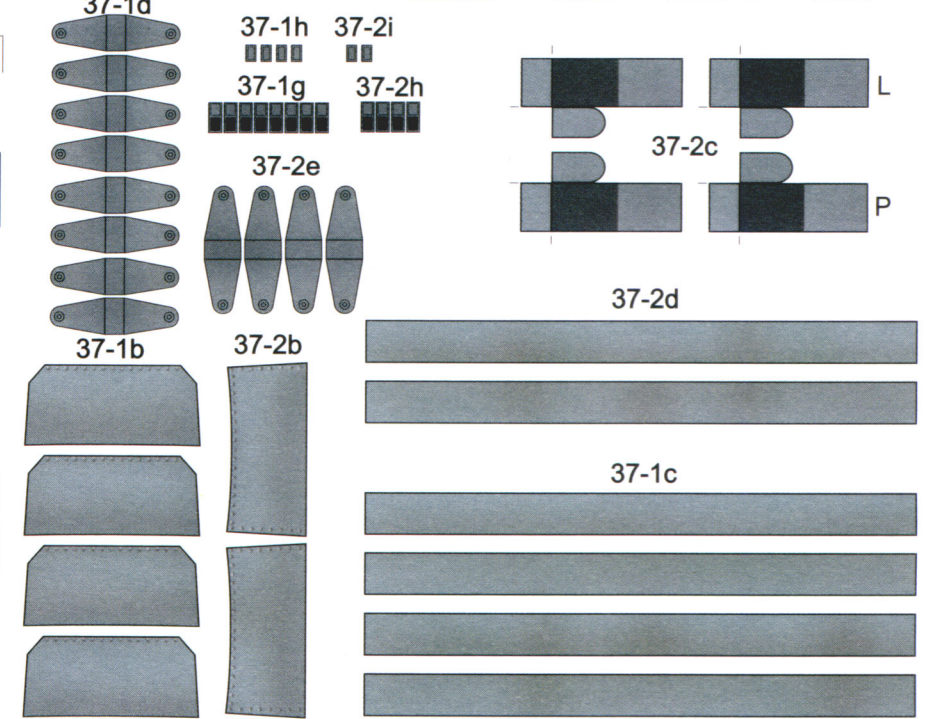
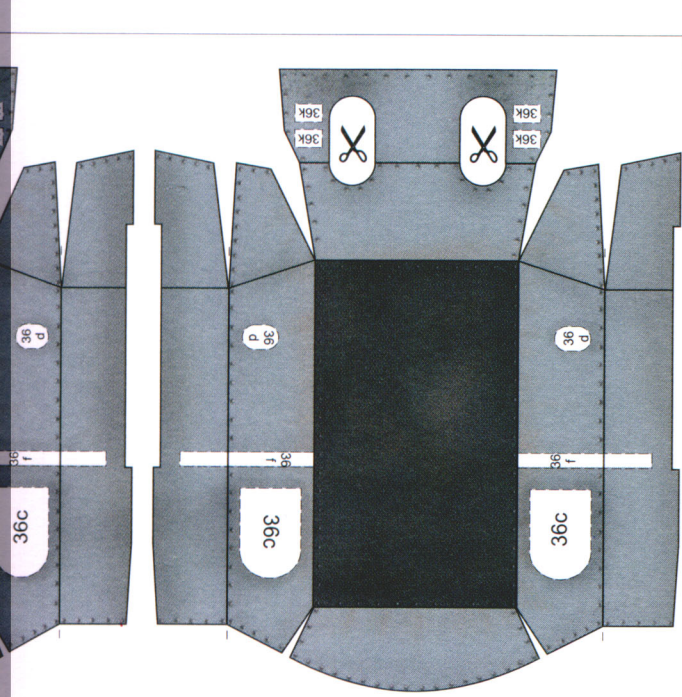
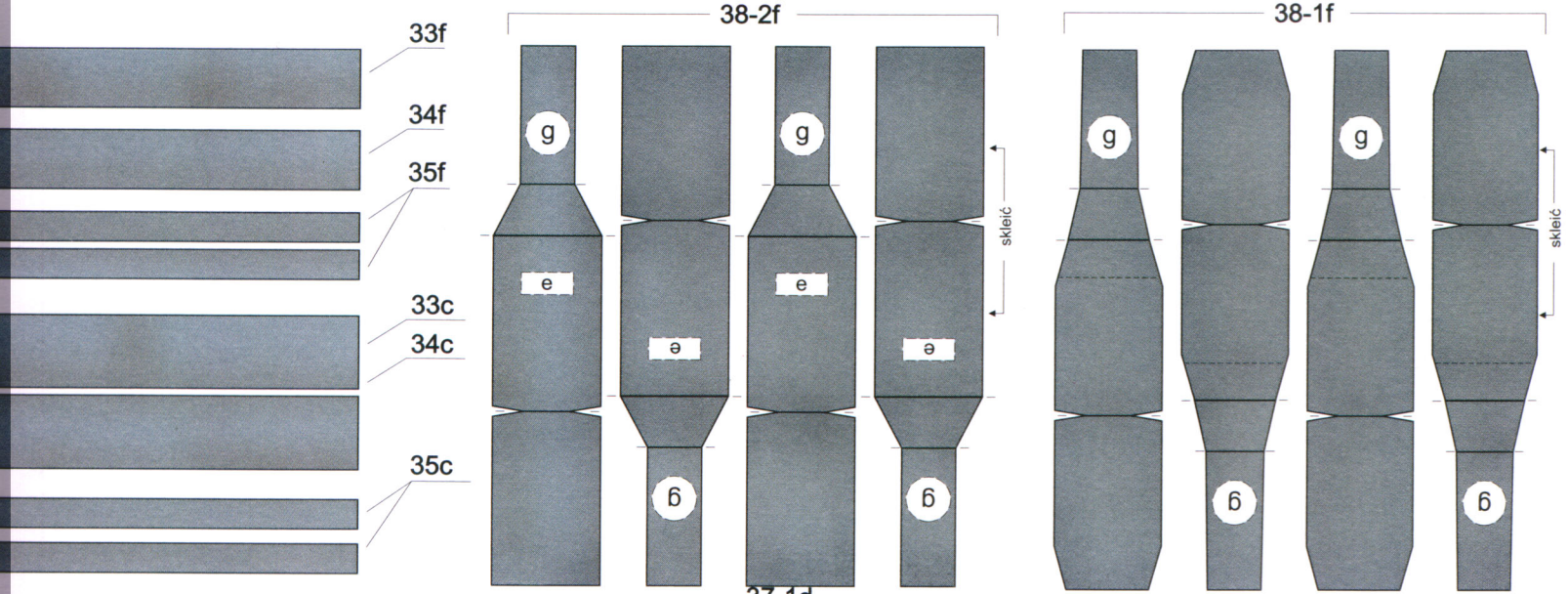

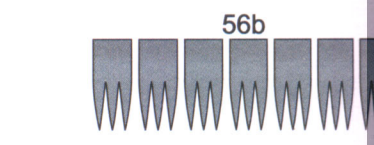
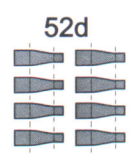
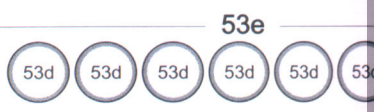
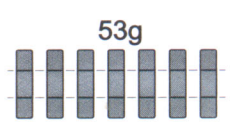
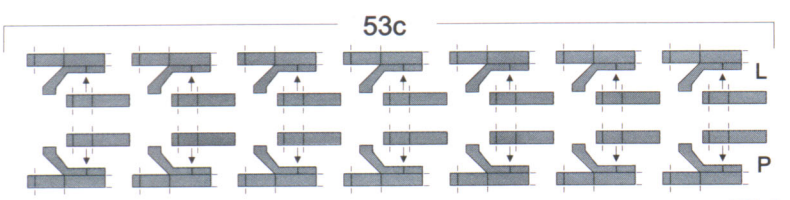
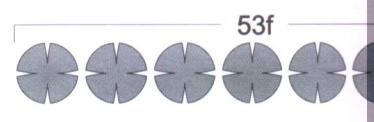
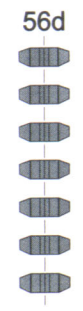
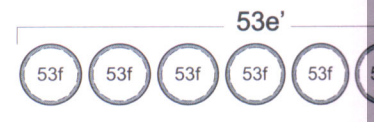
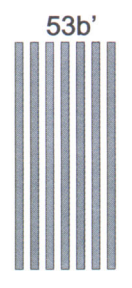
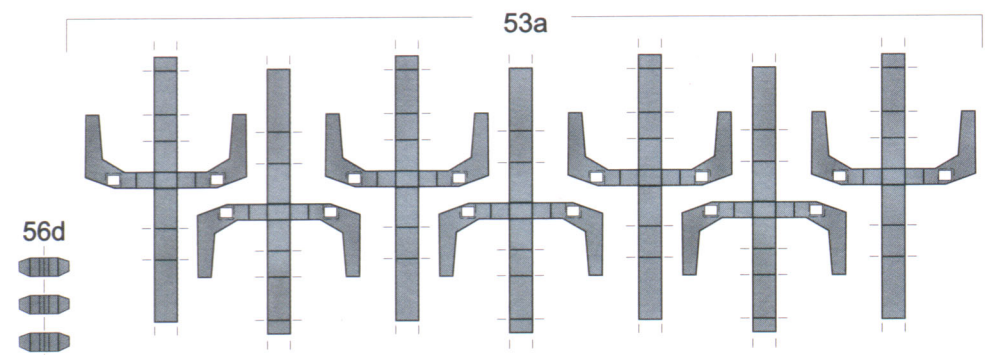
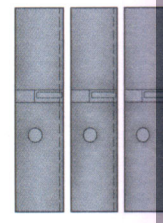
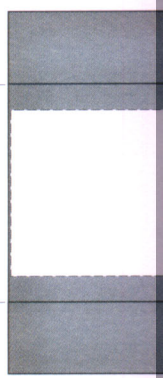
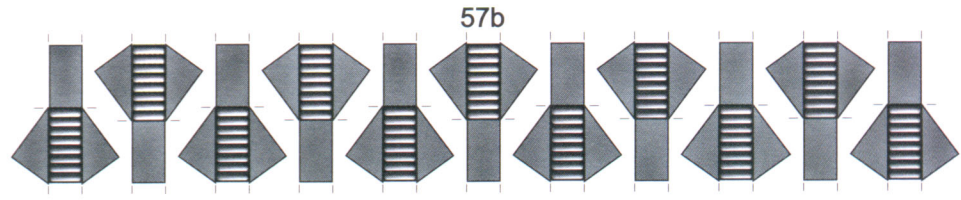
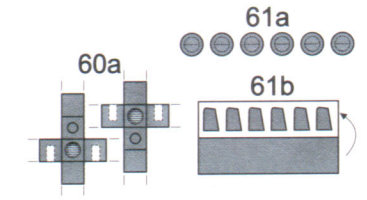
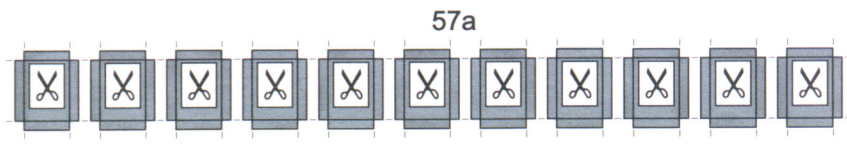
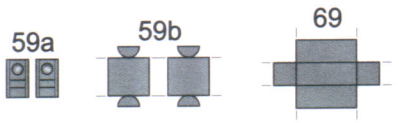
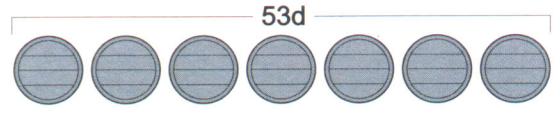
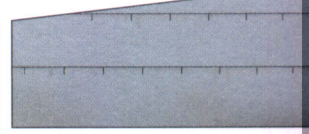
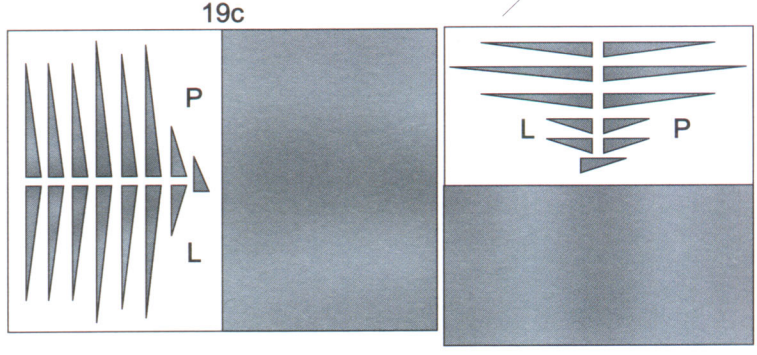
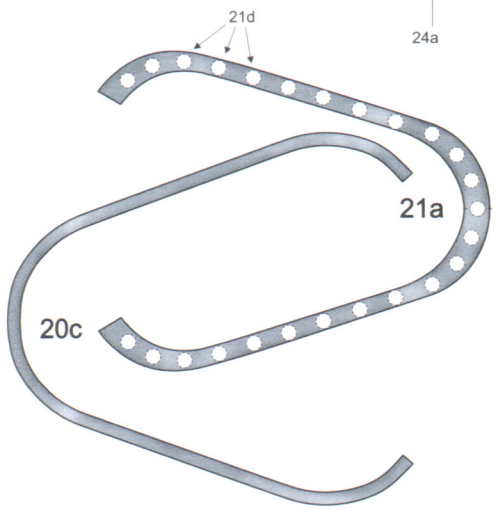
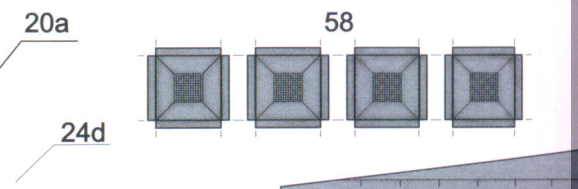
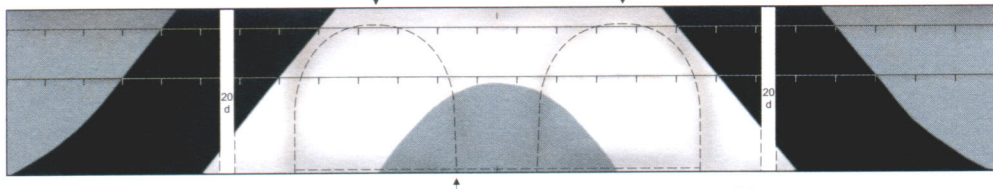
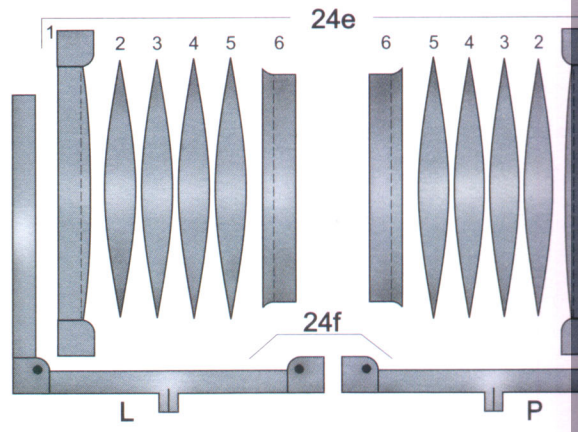
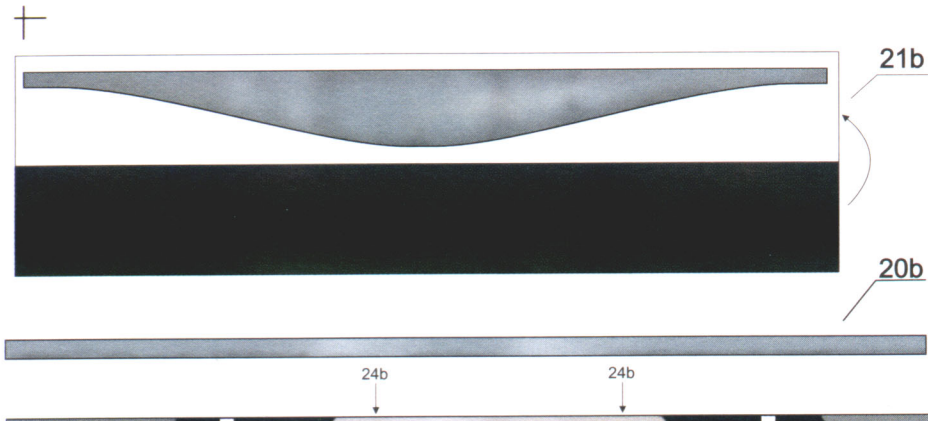

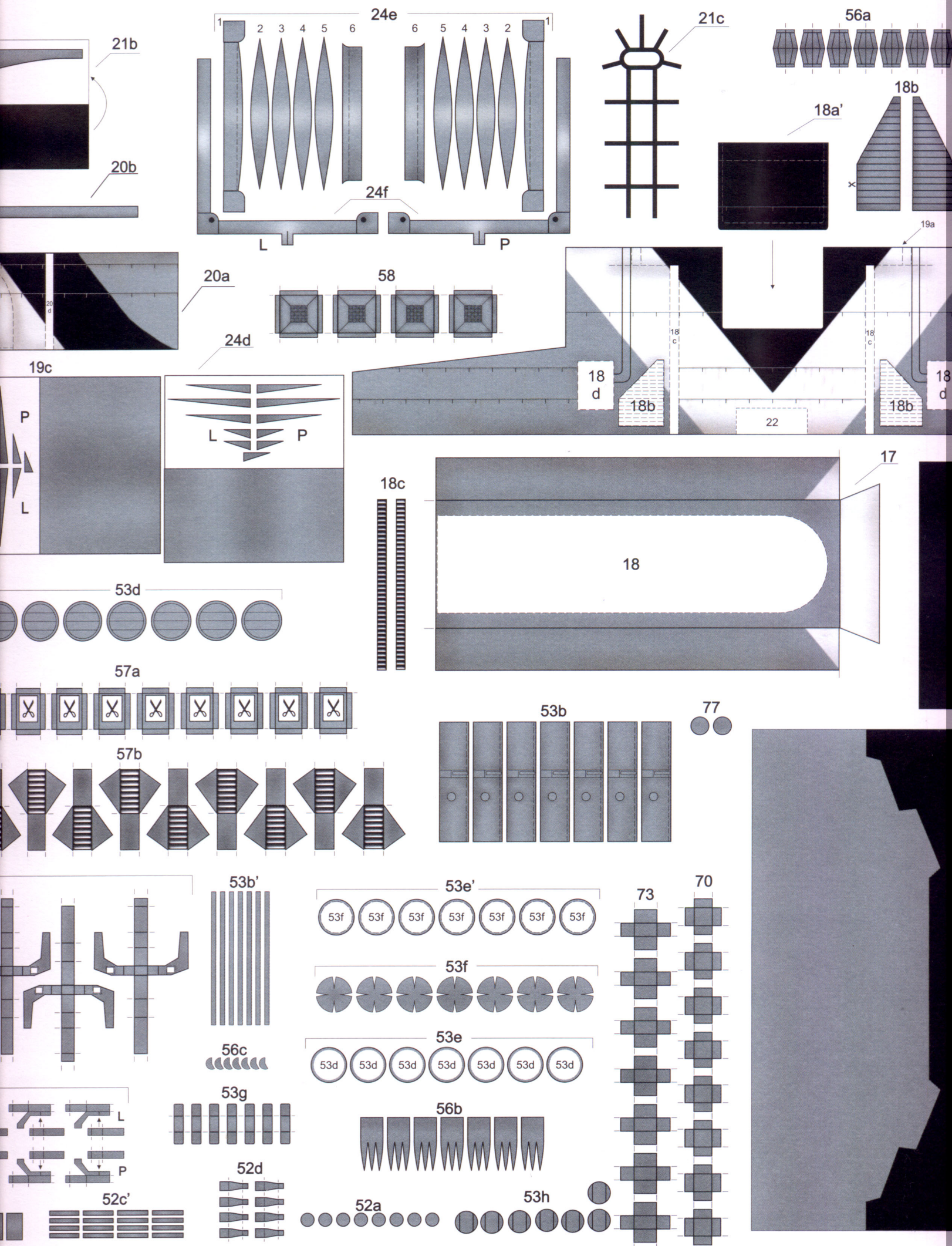

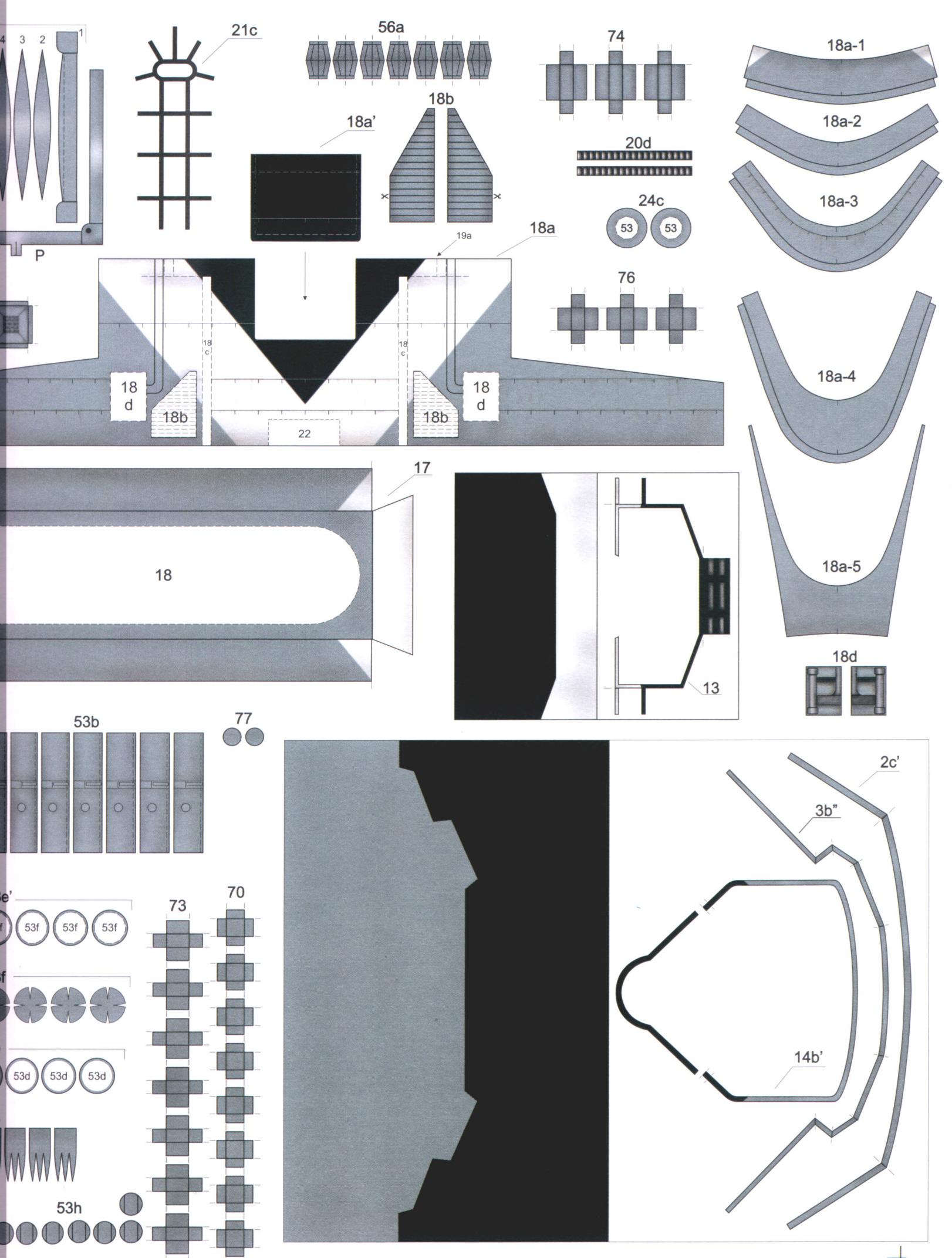



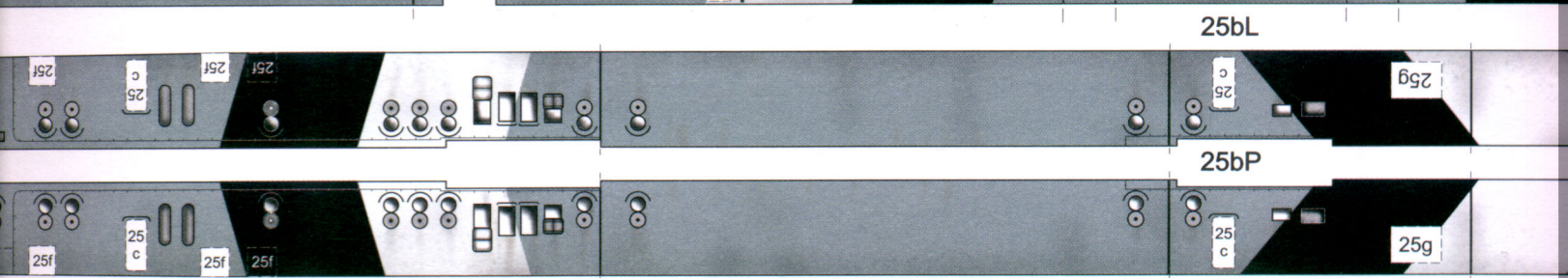
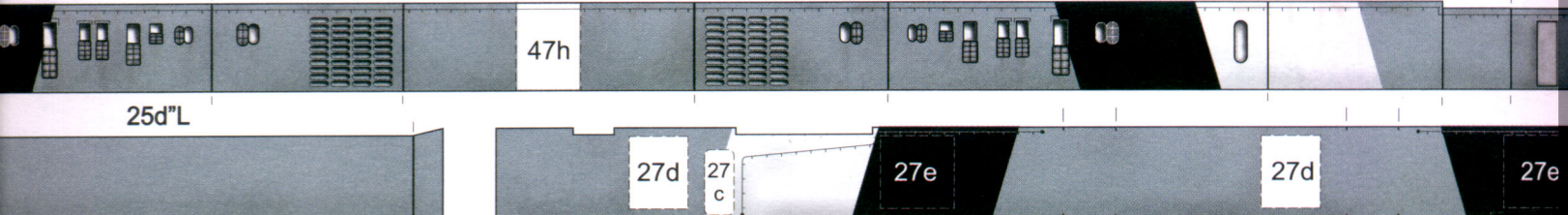
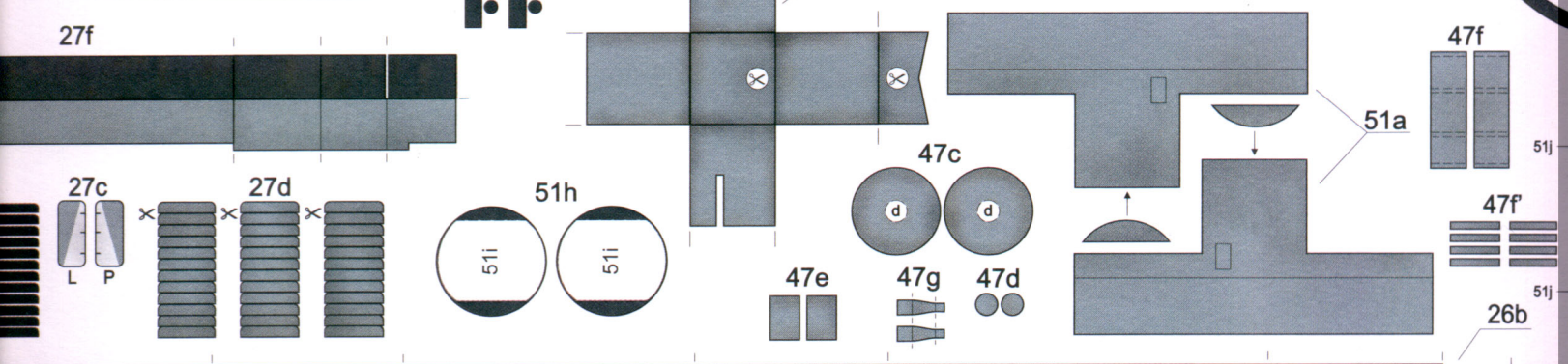
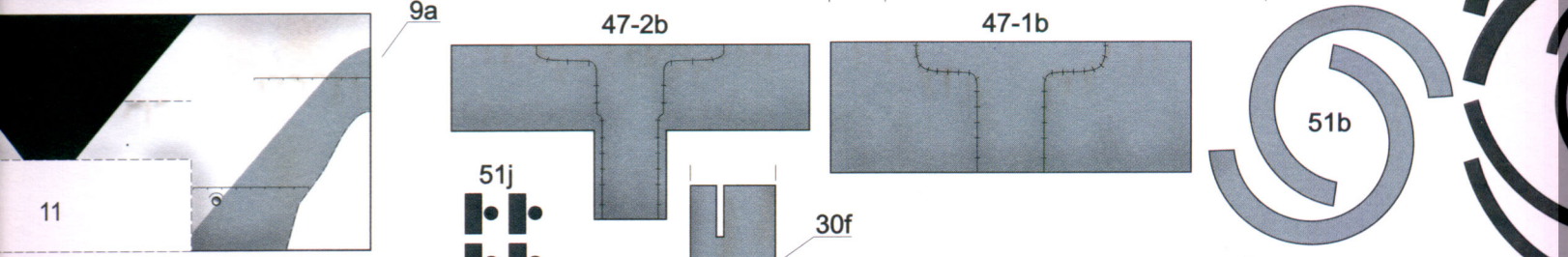
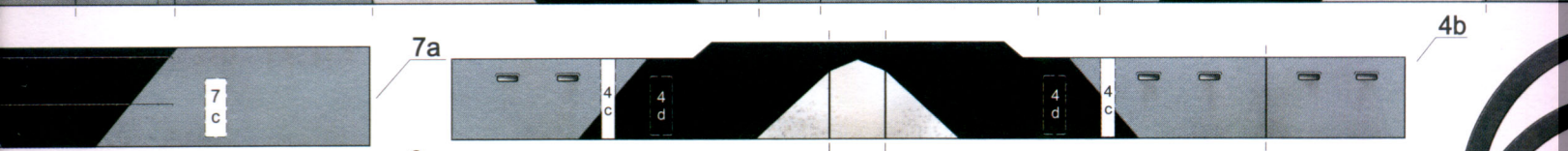
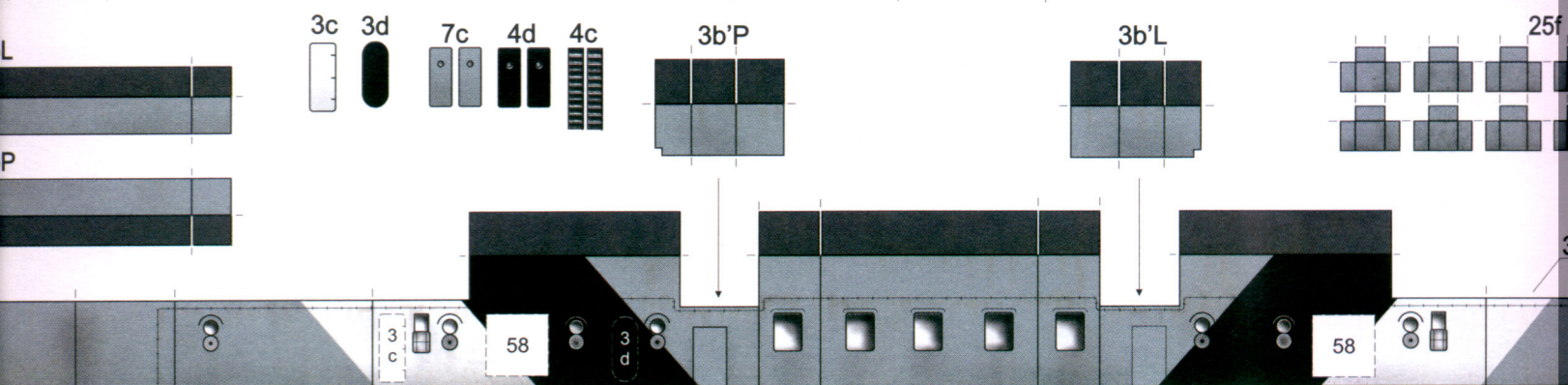
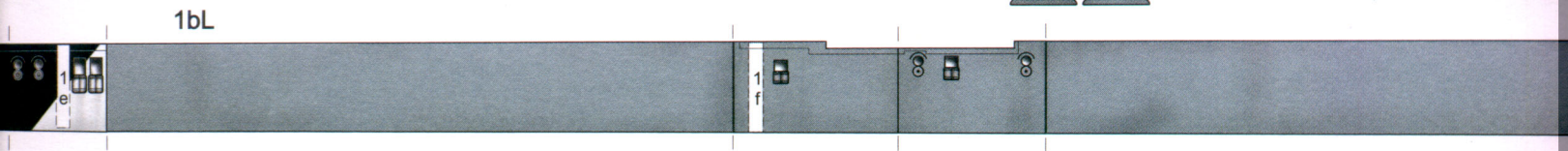
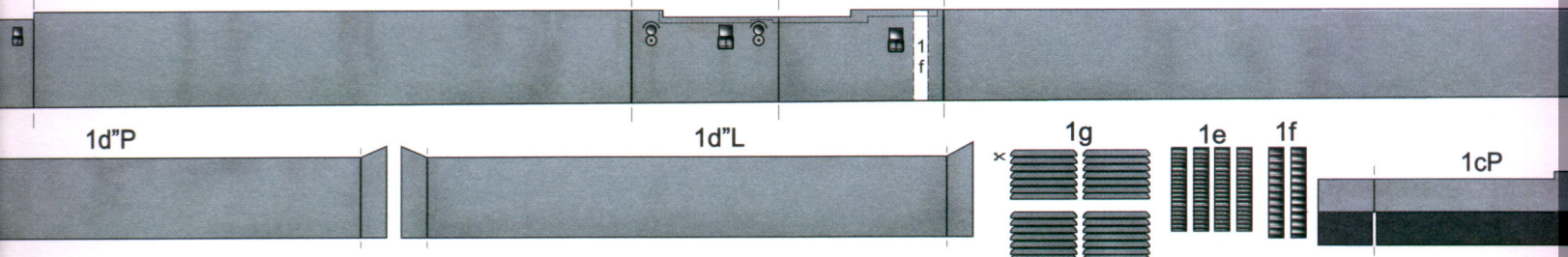



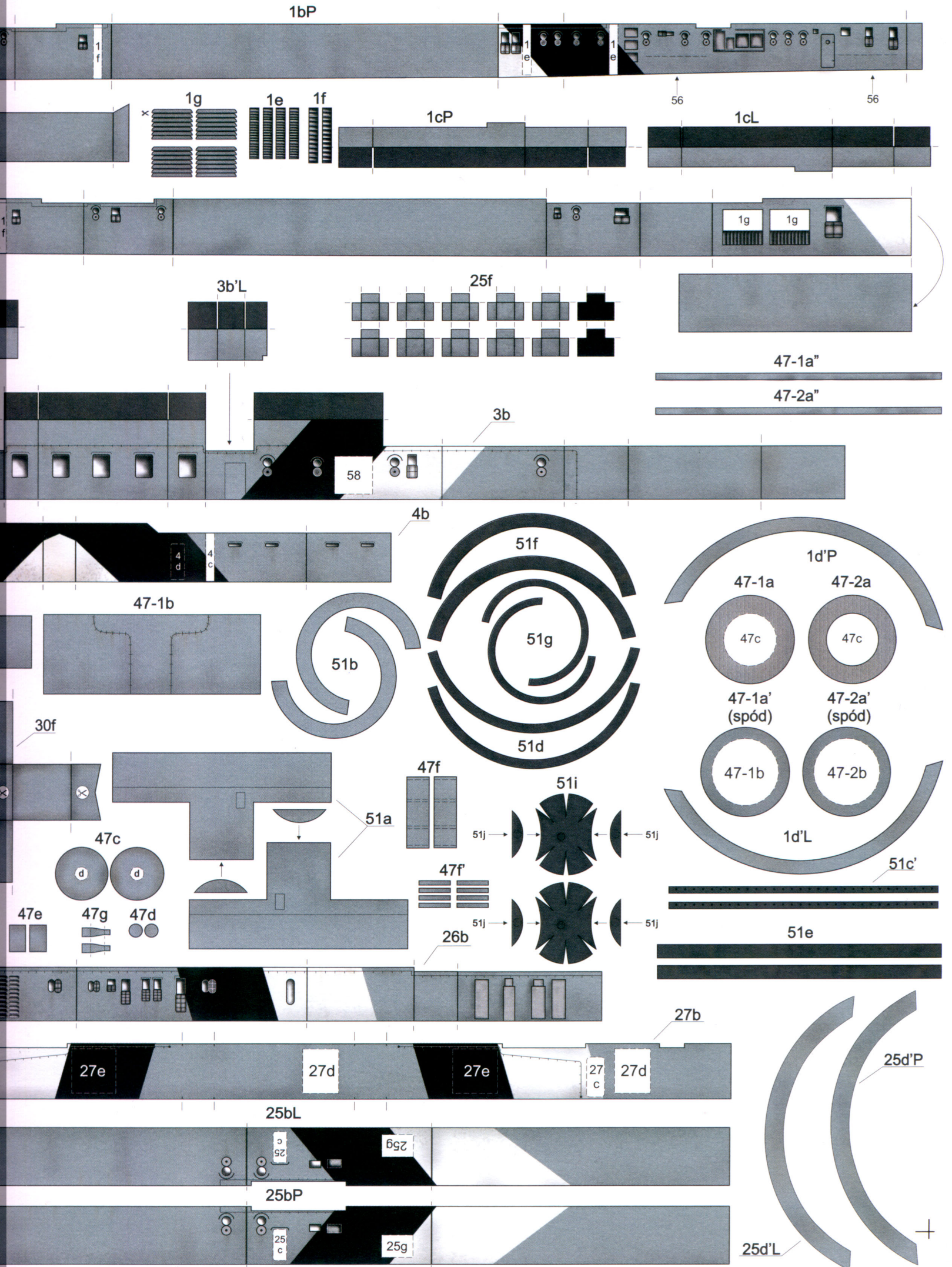



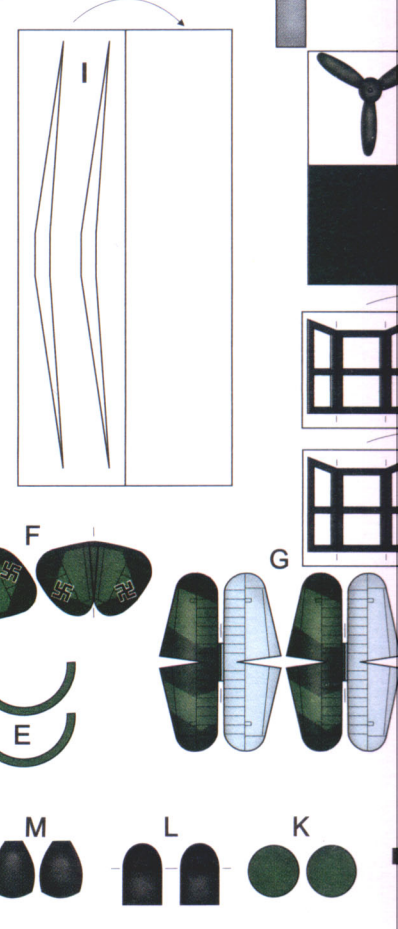
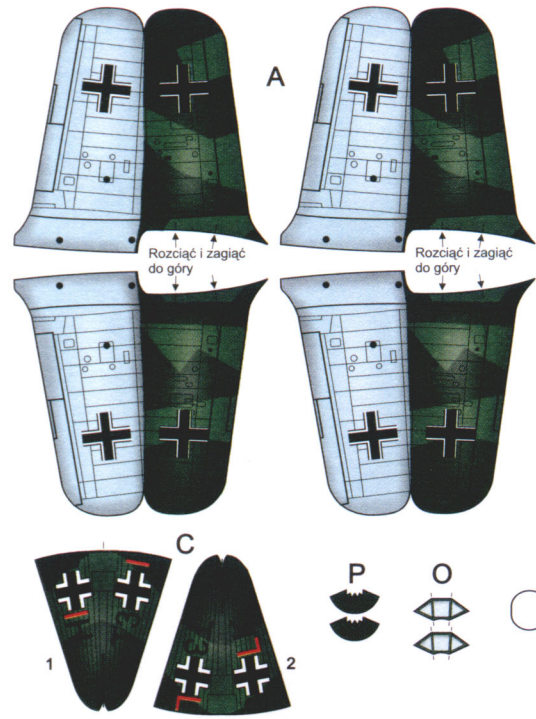
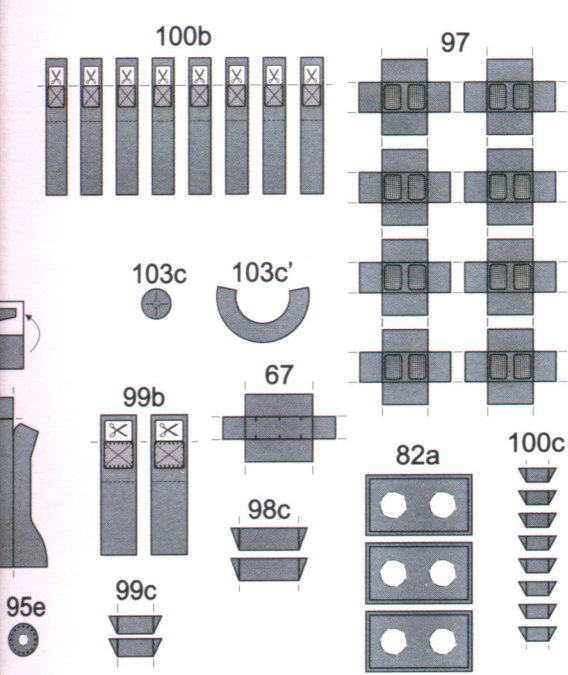
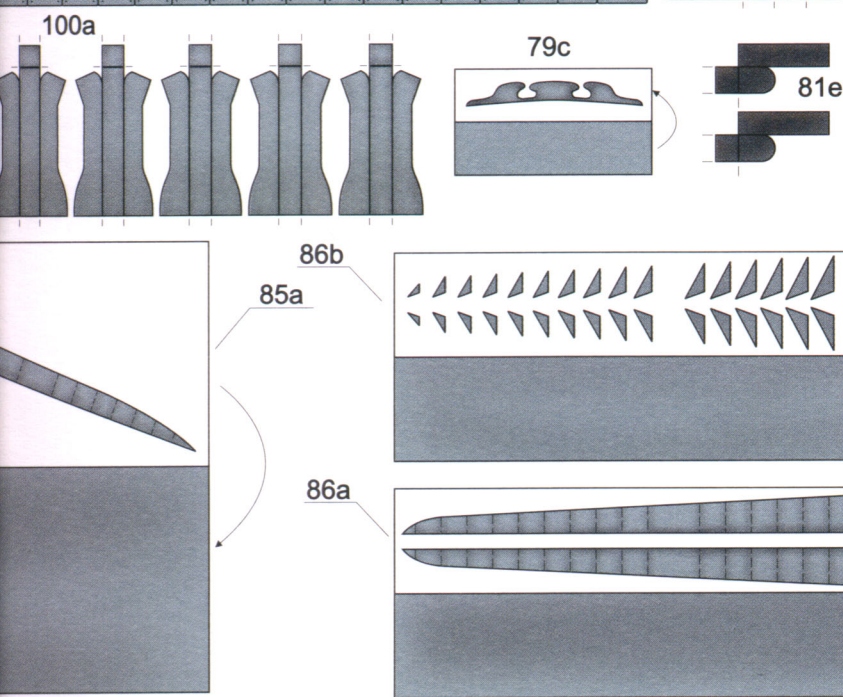
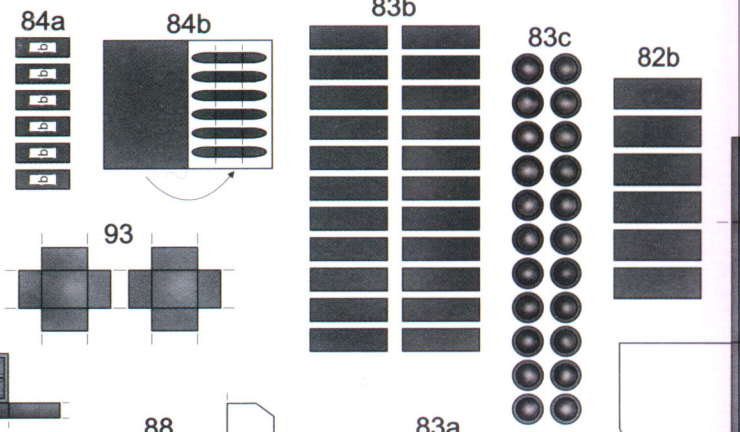
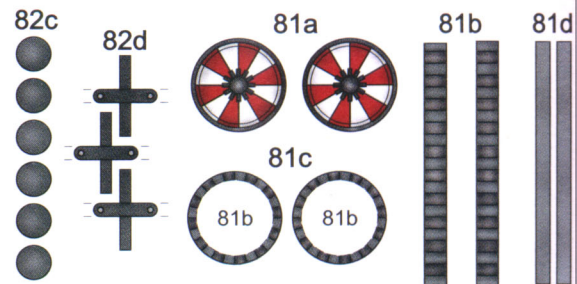
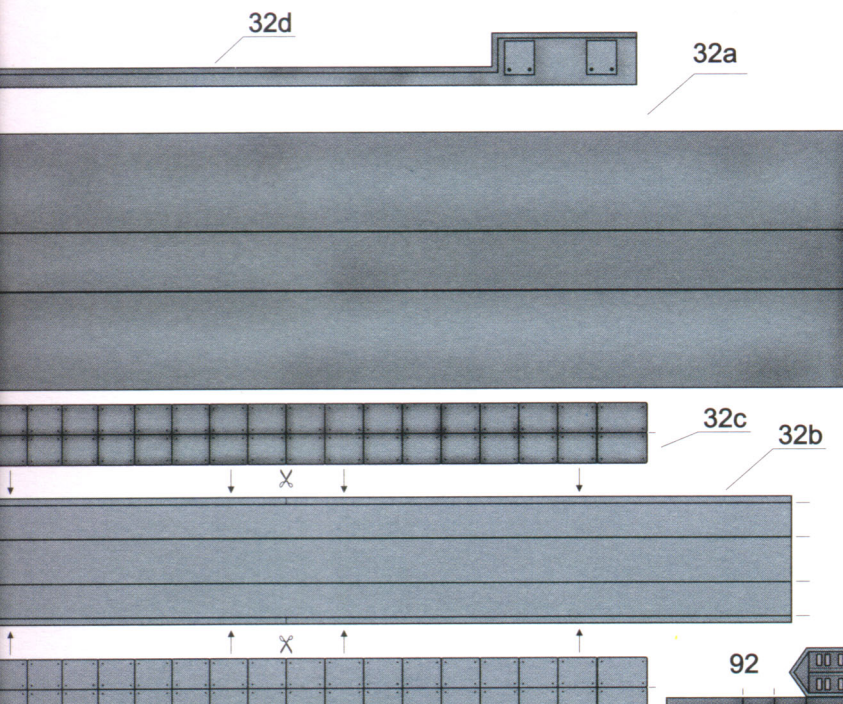

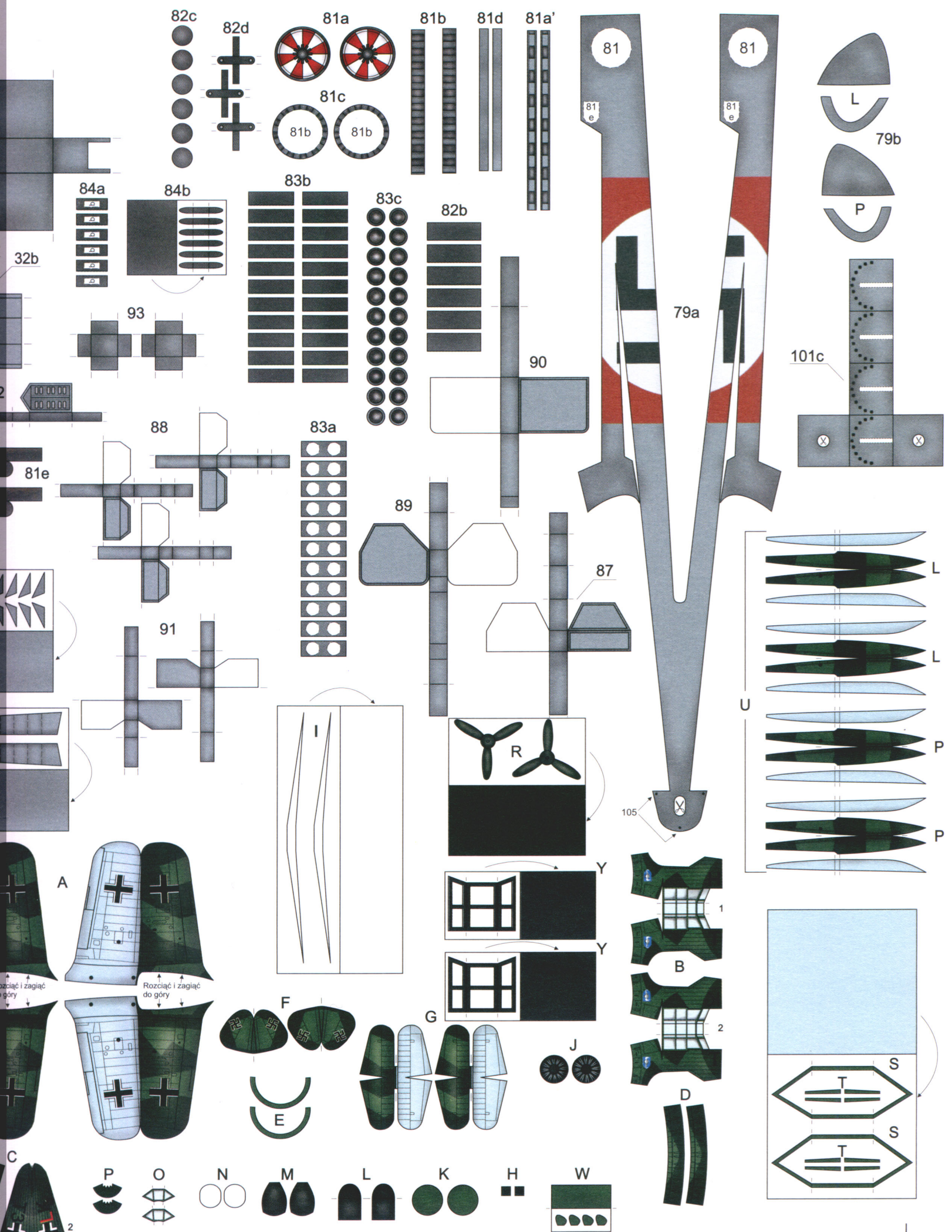

82c 82d 81a 81b 81d 81a'

81 81

81e 81e

84a 84b 83b 83c 82b 90

32b 93 88 89 87 101c

81e 91 83a 105

A B C

R

Y Y

F G J

E

D

P O N M L K H W

L P L P L P L P L P L P

U

S T S



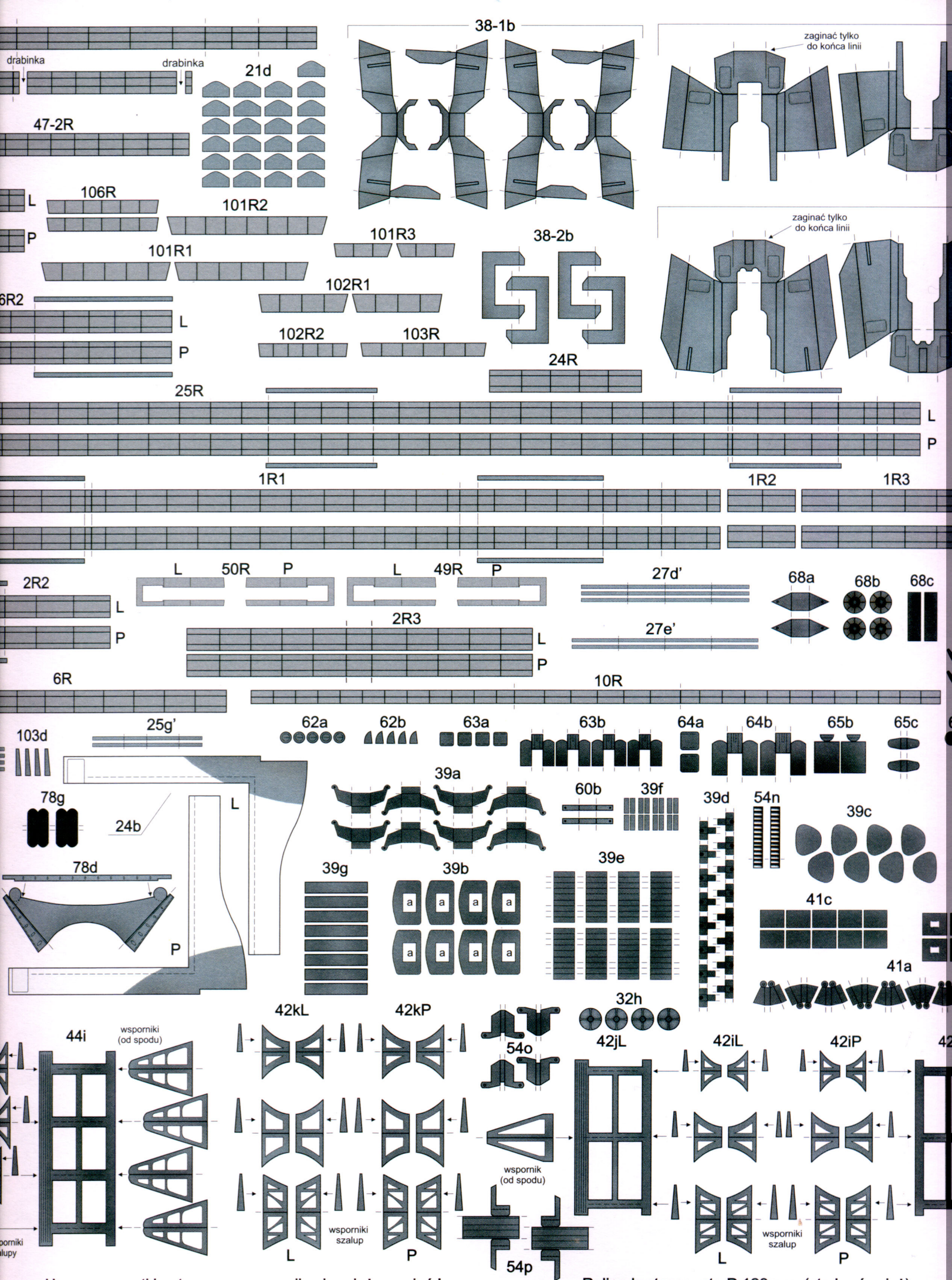

Uwaga: wszystkie otwory we wspornikach należy wyciąć !

Reling burtowy - str. P 128mm (str. L również)



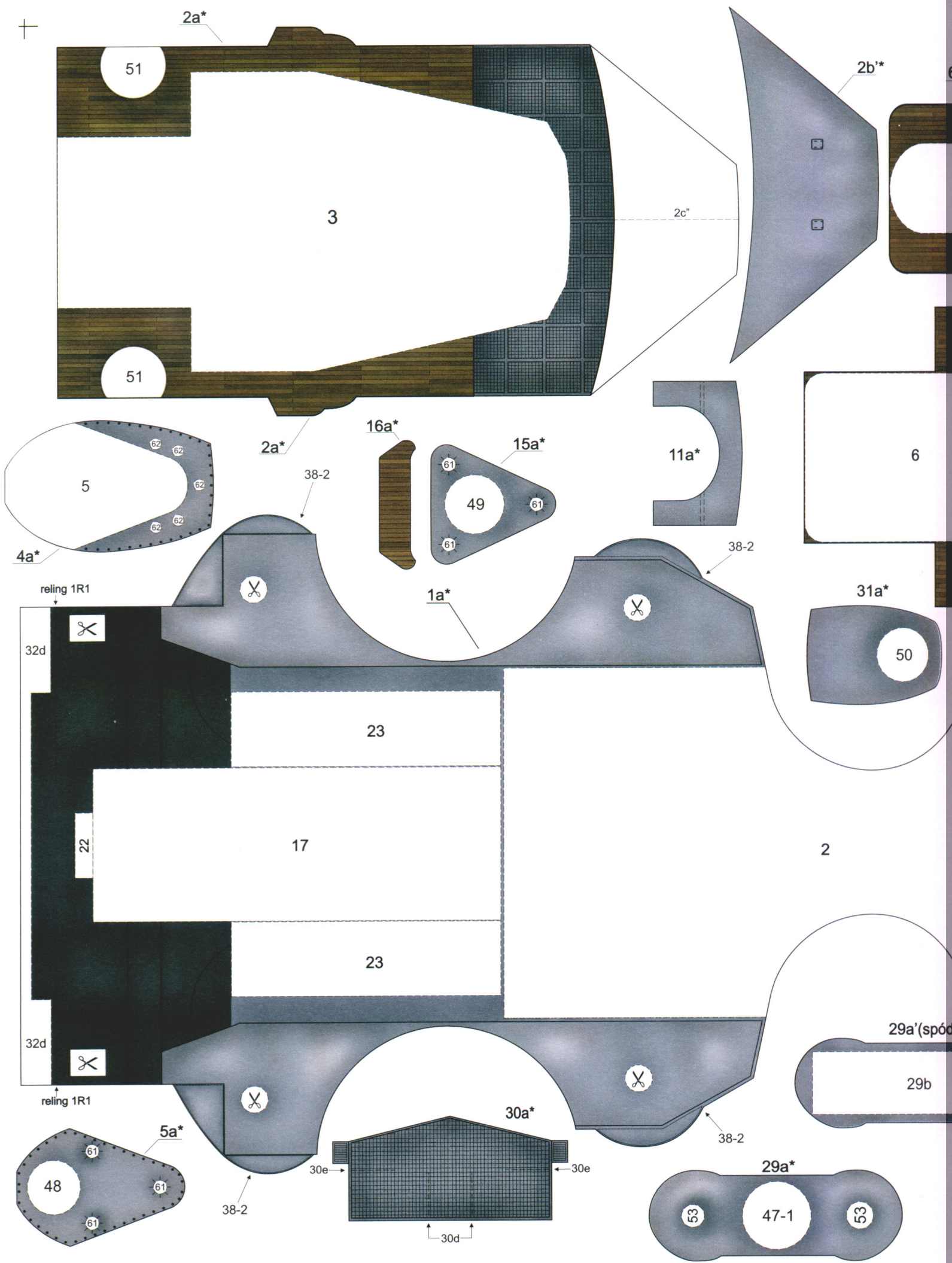



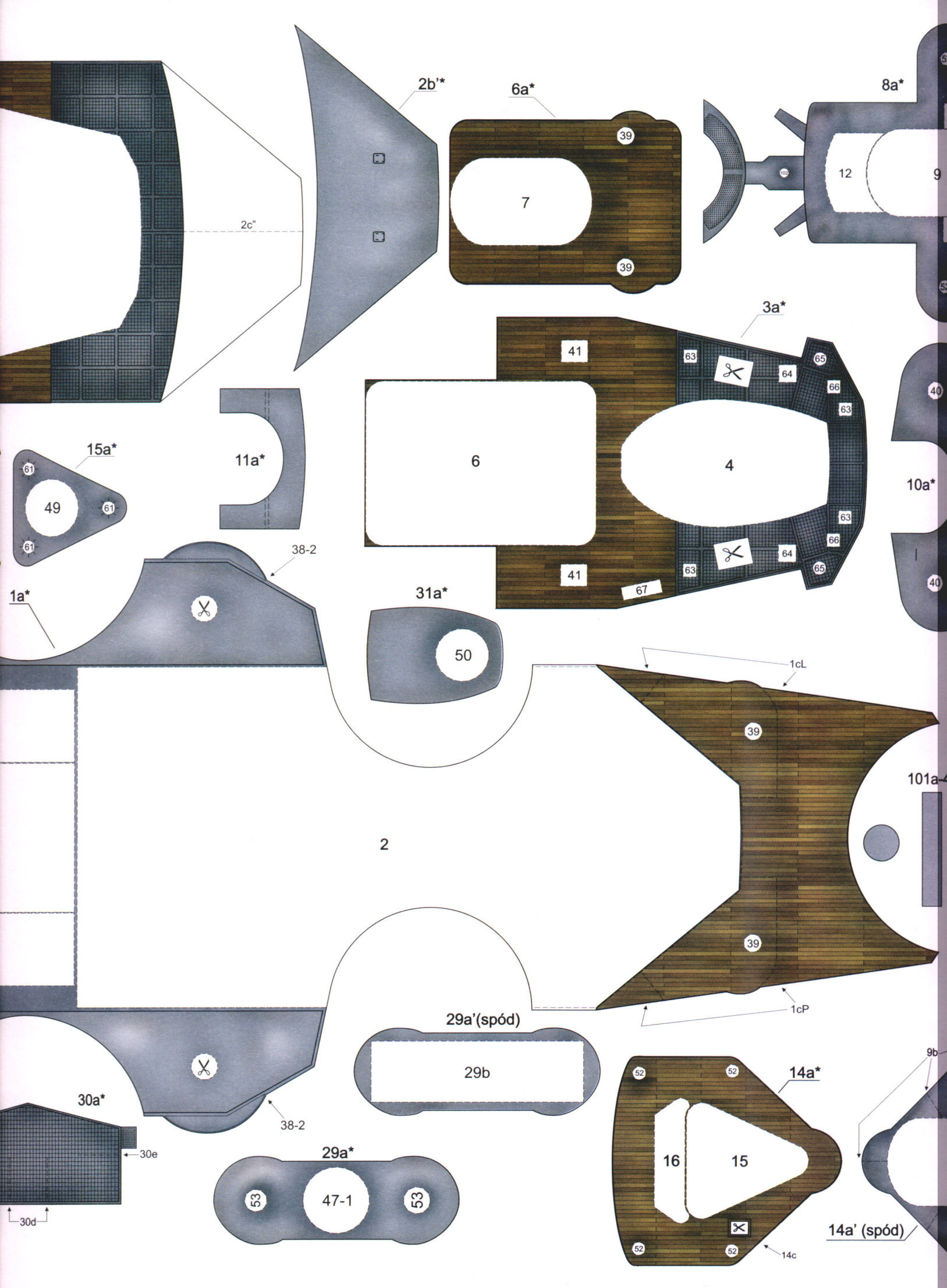

2b\*\*

6a\*

8a\*

2c''

7

12

9

3a\*

41

63

64

65

66

63

66

63

66

63

66

63

66

63

66

63

66

63

66

63

66

63

66

63

66

63

66

63

66

63

66

63

66

63

66

63

66

63

66

63

66

63

66

63

66

63

66

63

66

63

66

63

66

63

66

10a\*

40

101a-4

15a\*

11a\*

6

4

31a\*

50

1a\*

38-2

1cL

2

39

39

29a'(spód)

29b

1cP

30a\*

38-2

29a\*

52

47-1

52

14a\*

16

15

14a' (spód)

14c

30d

30e

9b

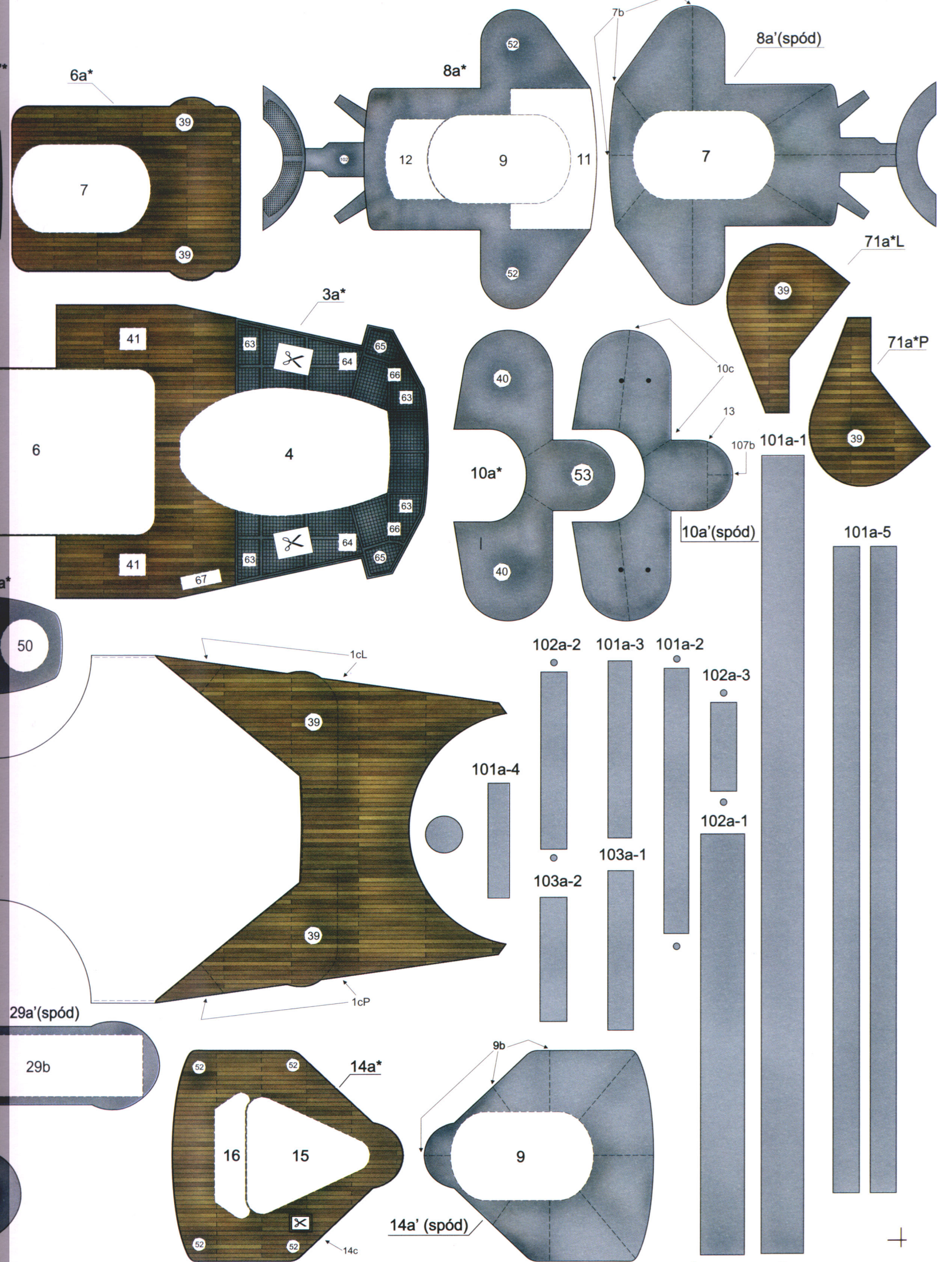

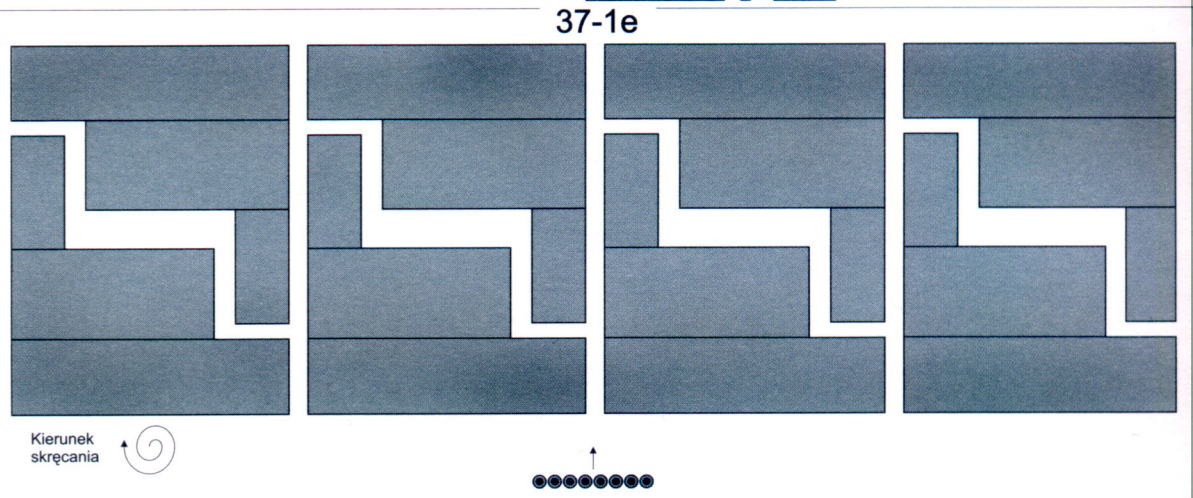
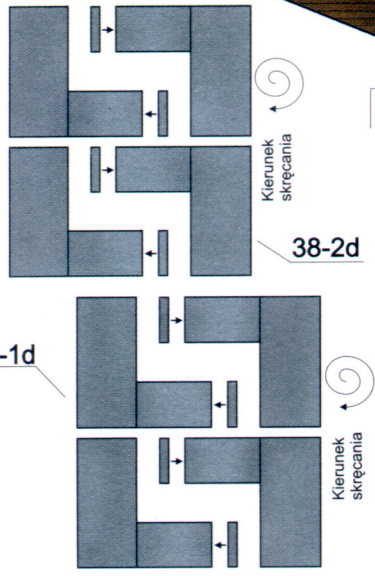
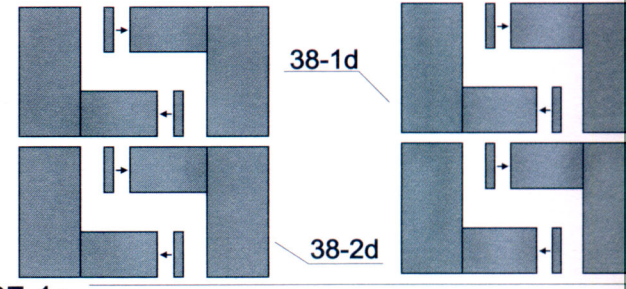
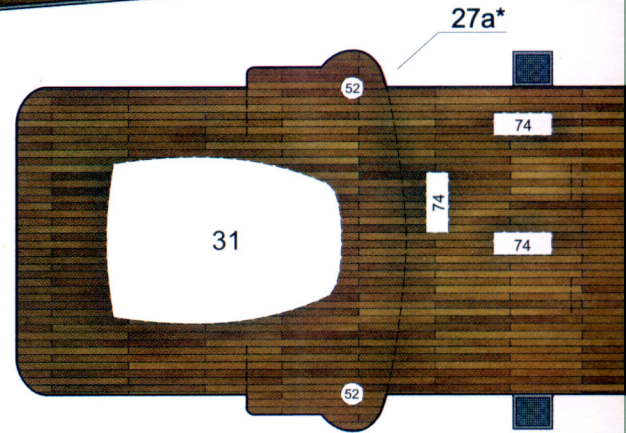
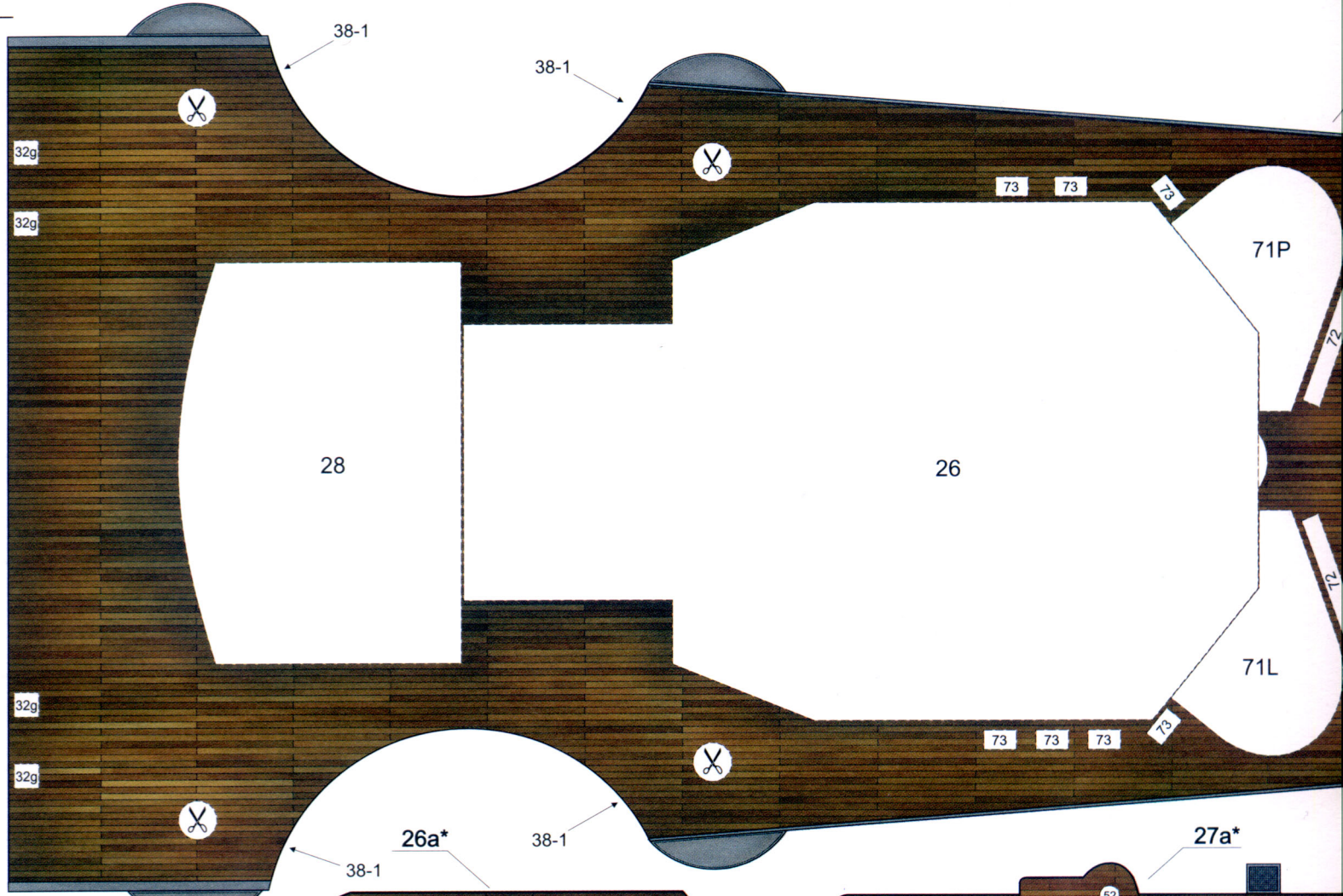

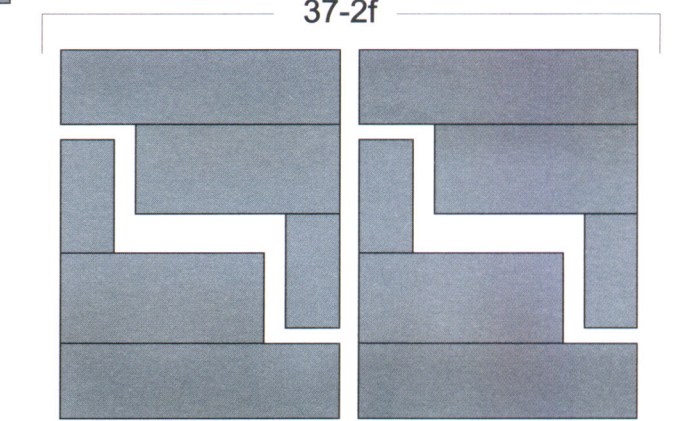
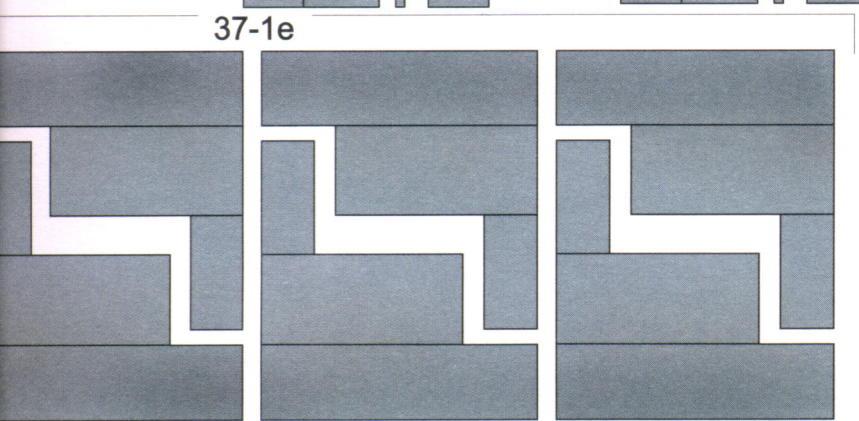
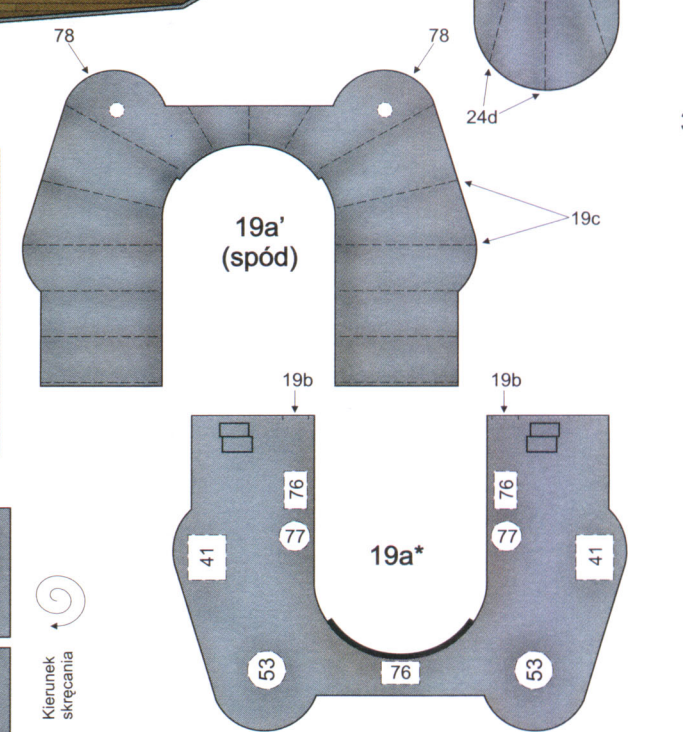
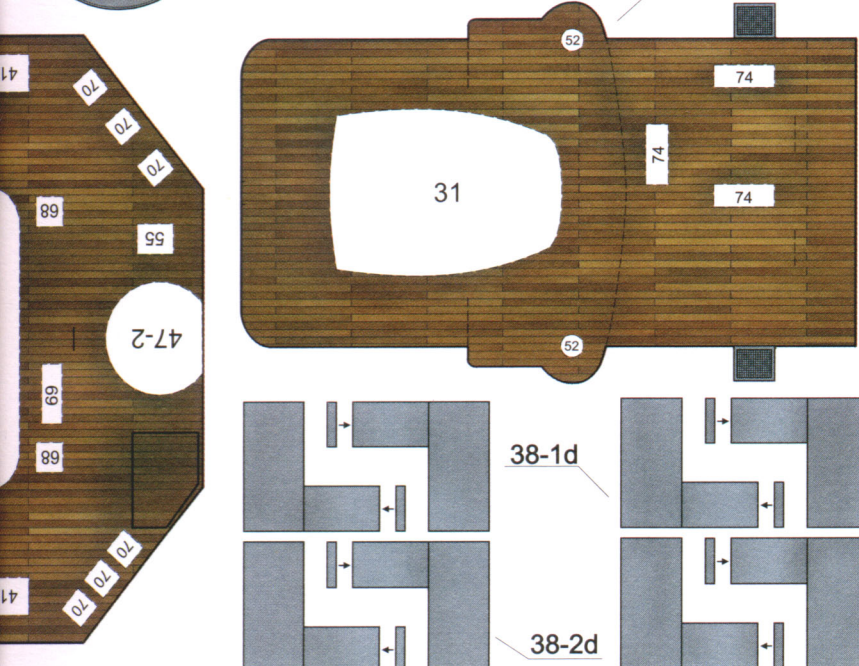
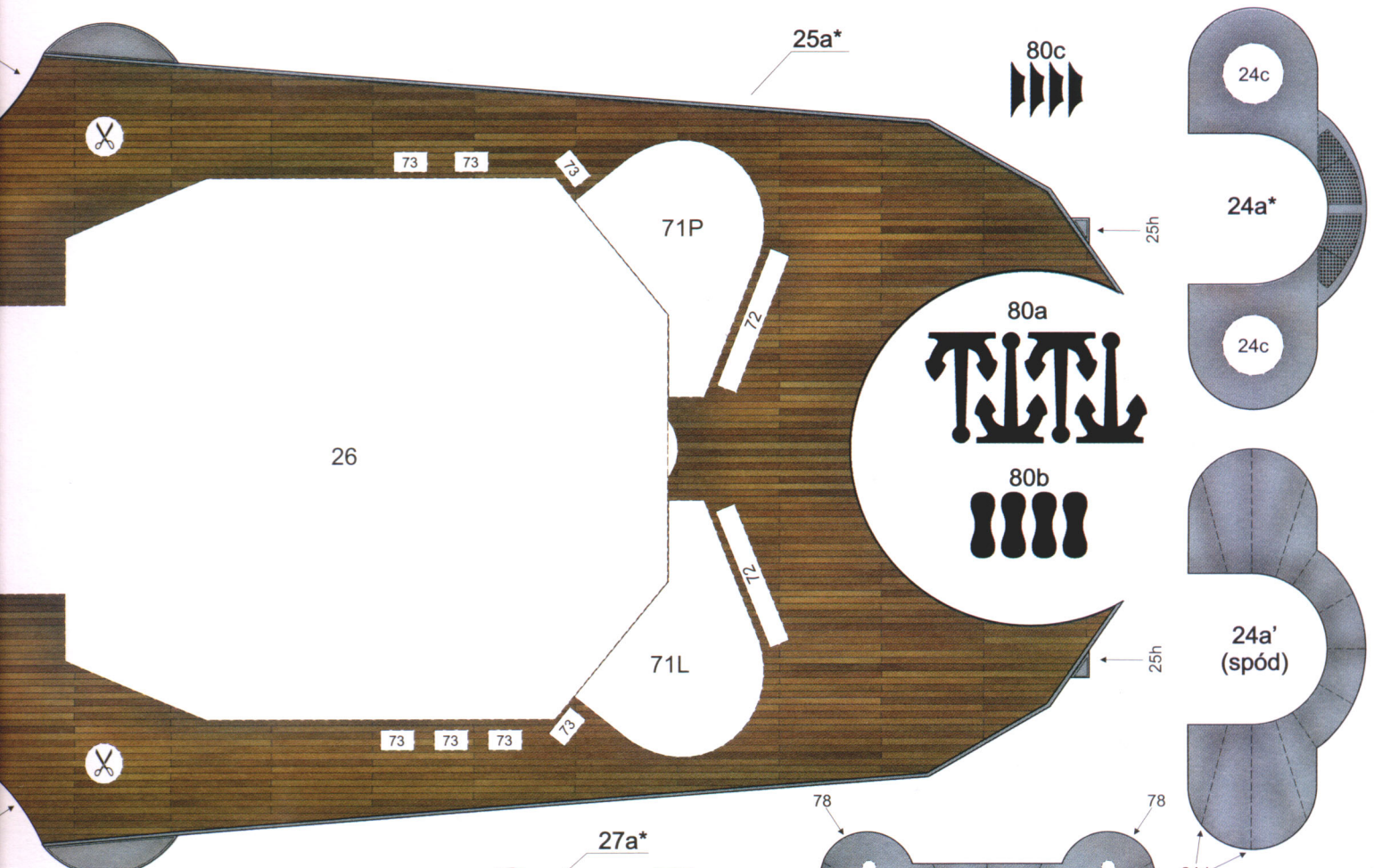

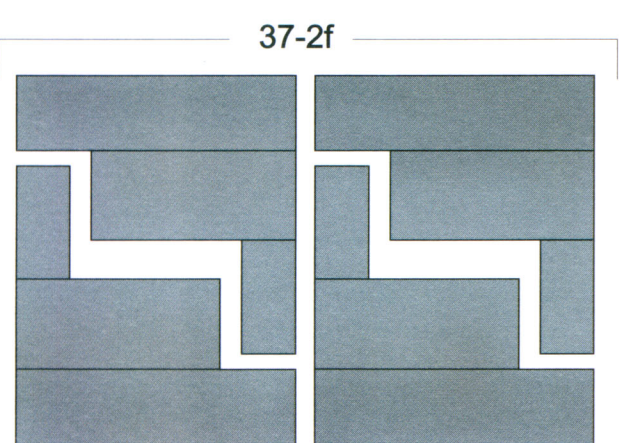
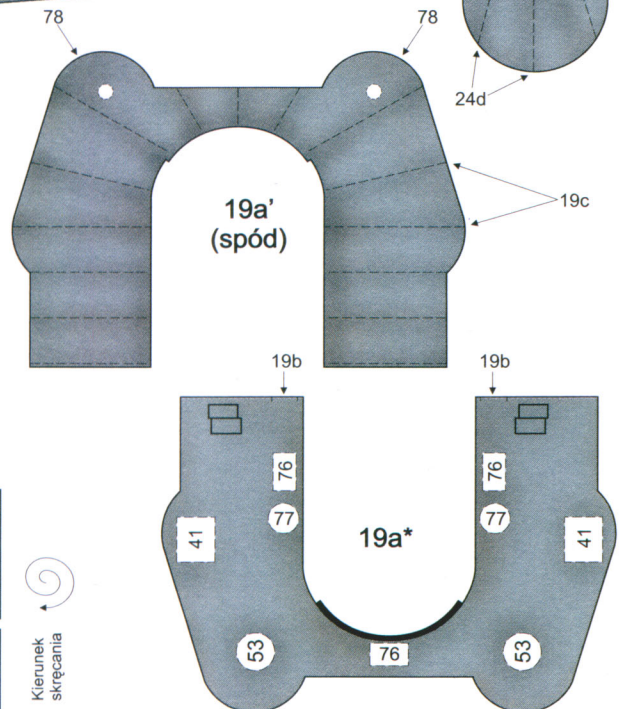
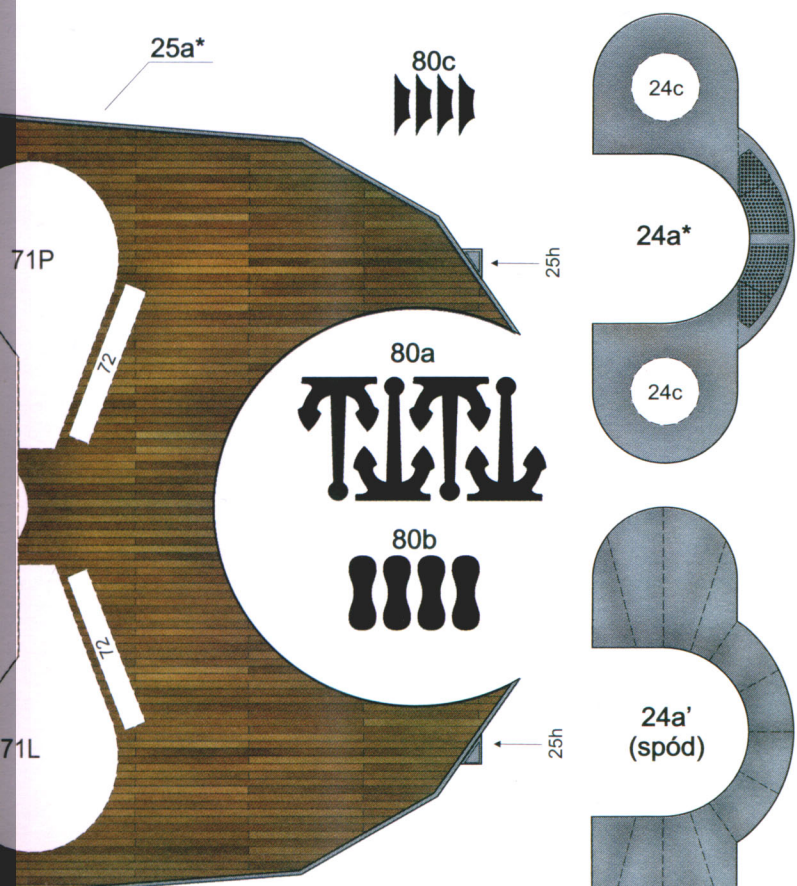

36g

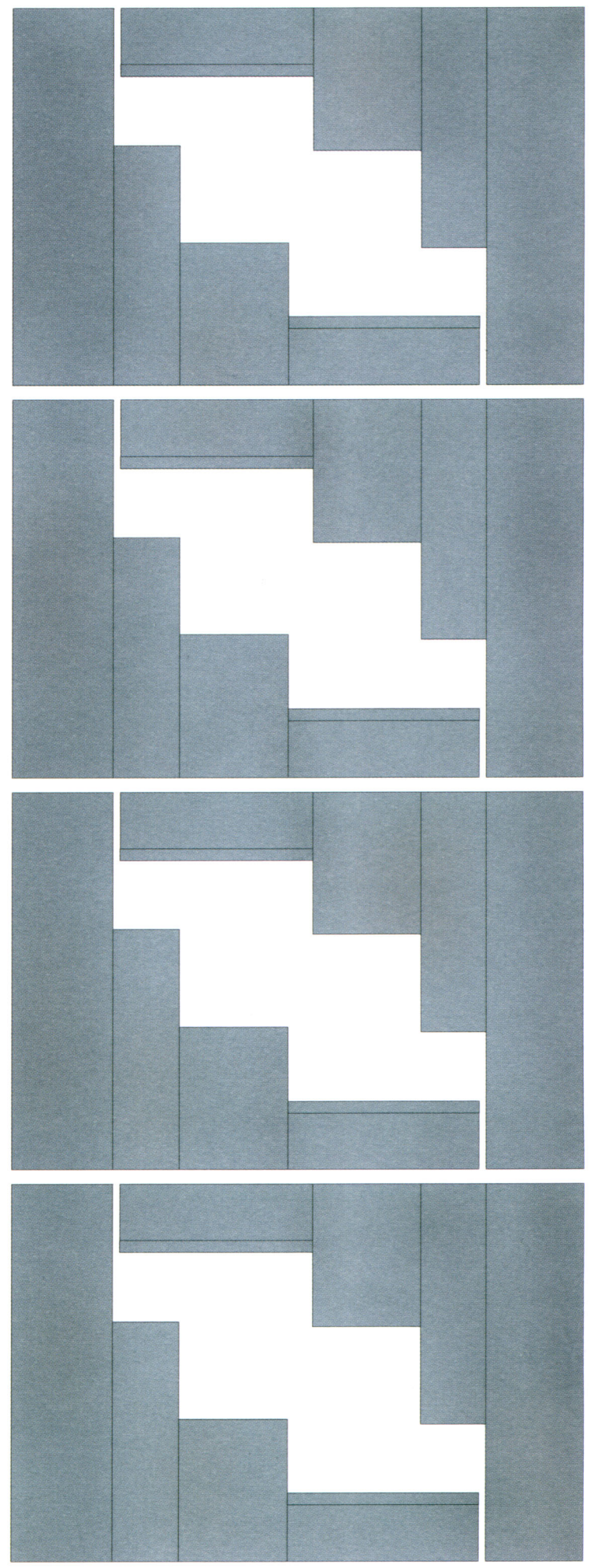

+ Uwaga : Elementy oznaczone symbolem \*\*\* - podkleić tekturą gr. 3 mm.

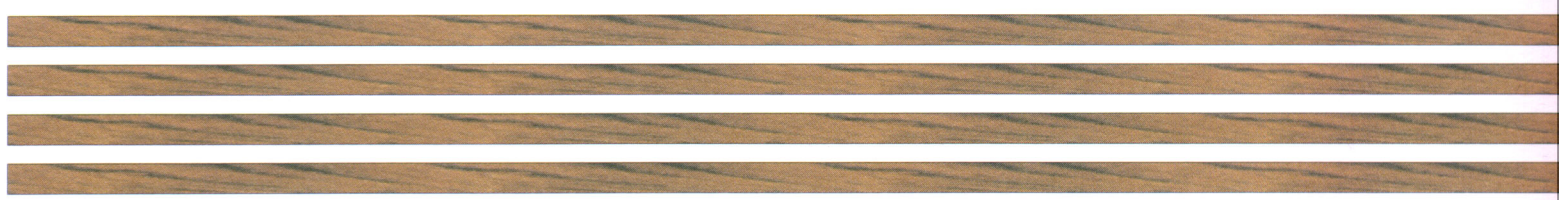
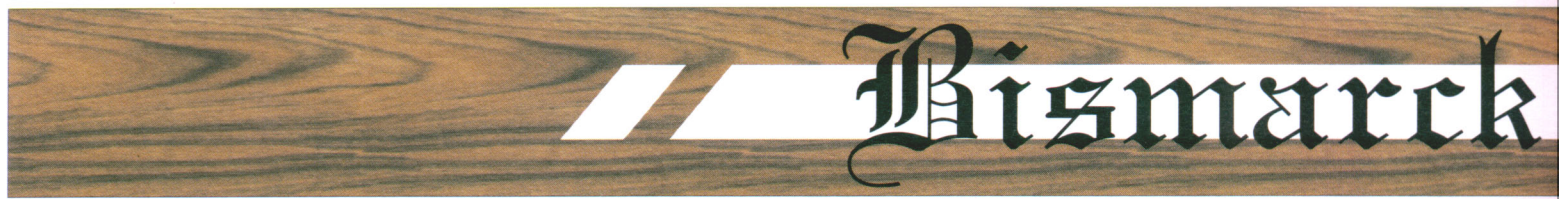
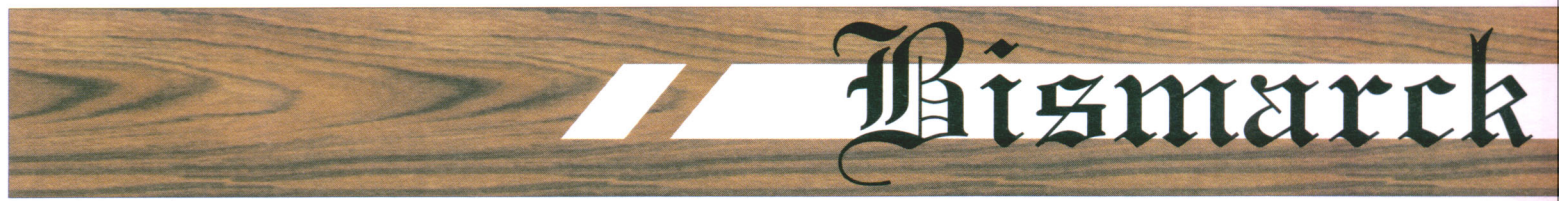
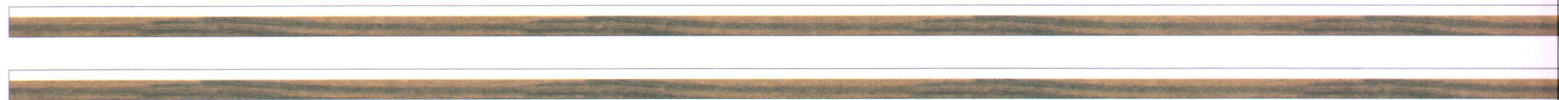
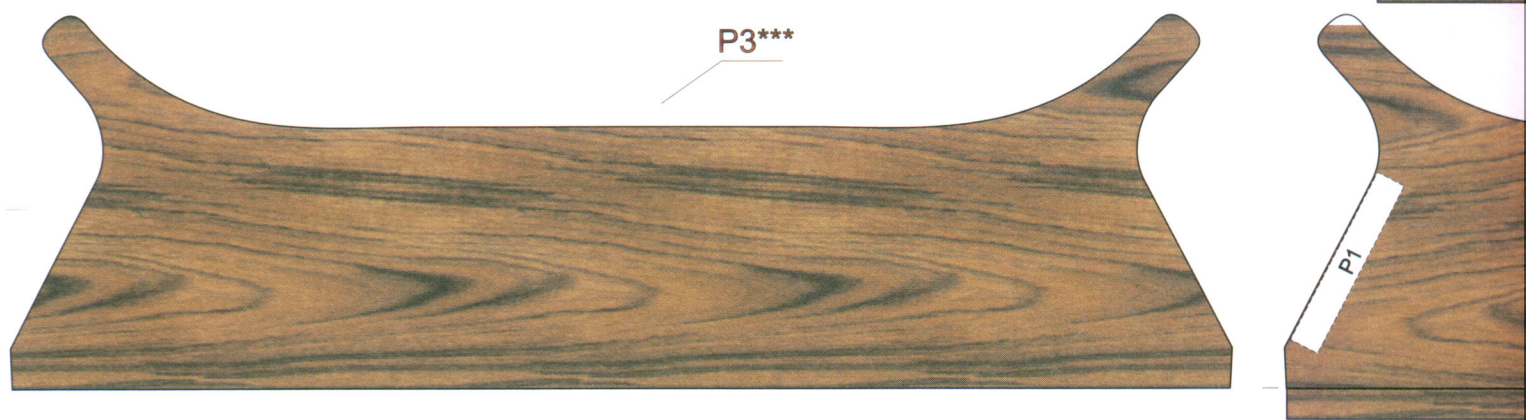
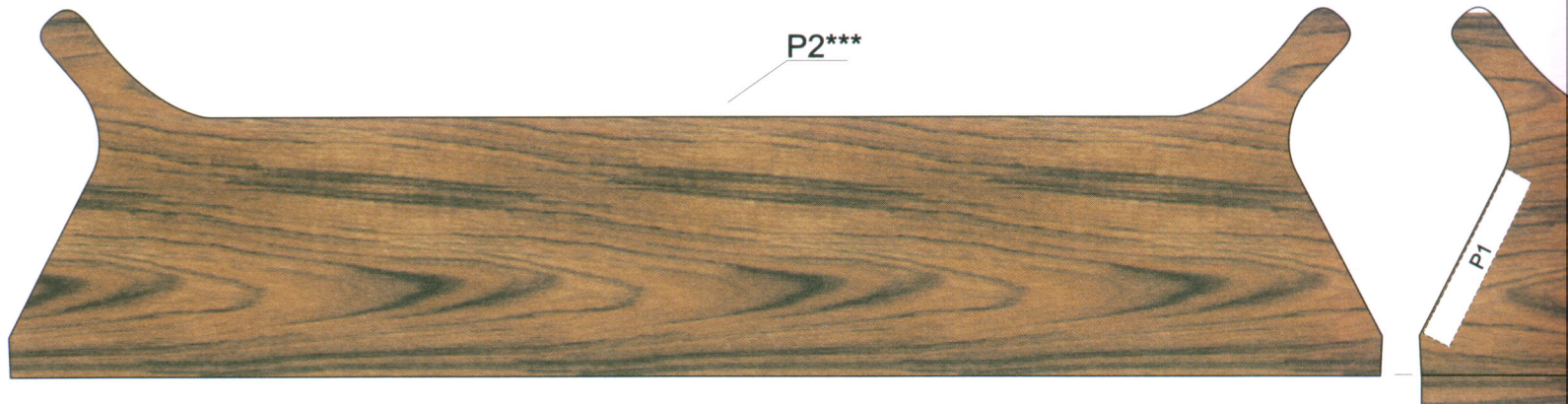

Zapas koloru do ewentualnego uzupełnienia ubytków:

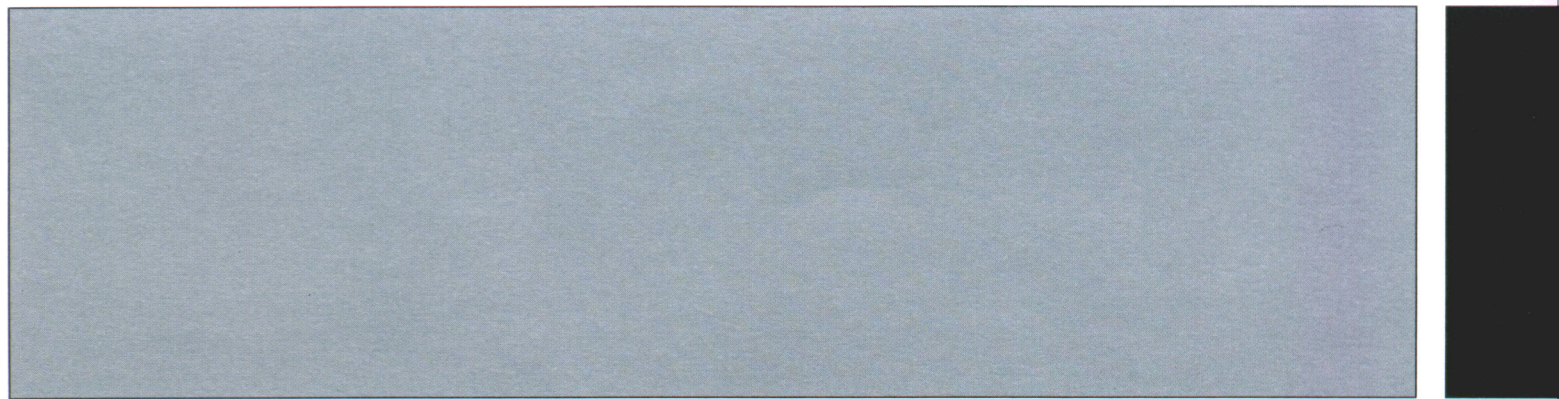

olem \*\*\* - podkleić teksturą gr. 3 mm.

P2\*\*\*

P2'(spód)

P3\*\*\*

P3'(spód)

P1

P1

P3''

Bismarck

Bismarck

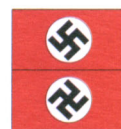
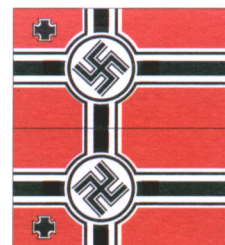

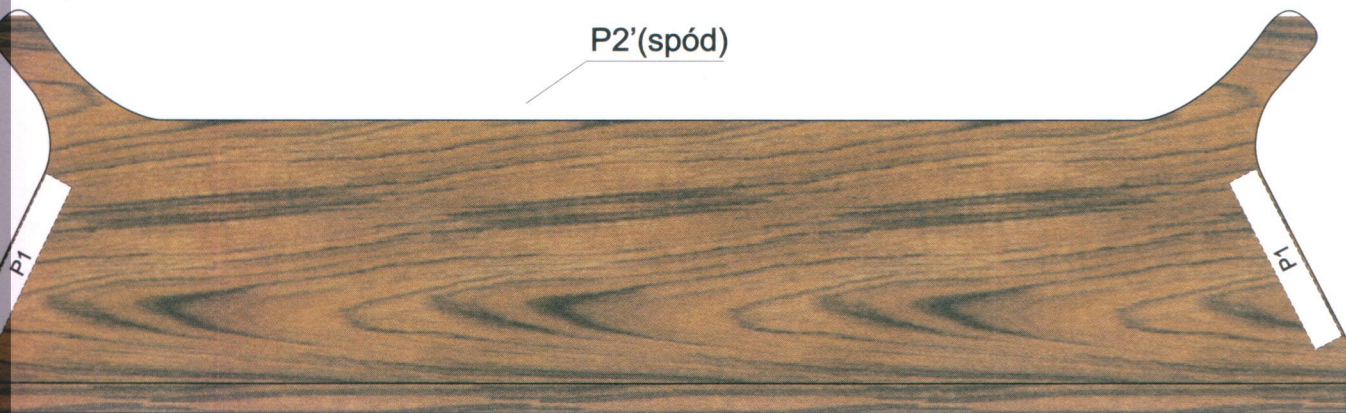

P2'(spód)

Herb okrętu



Do przyklejenia pod kotwicą dziobową

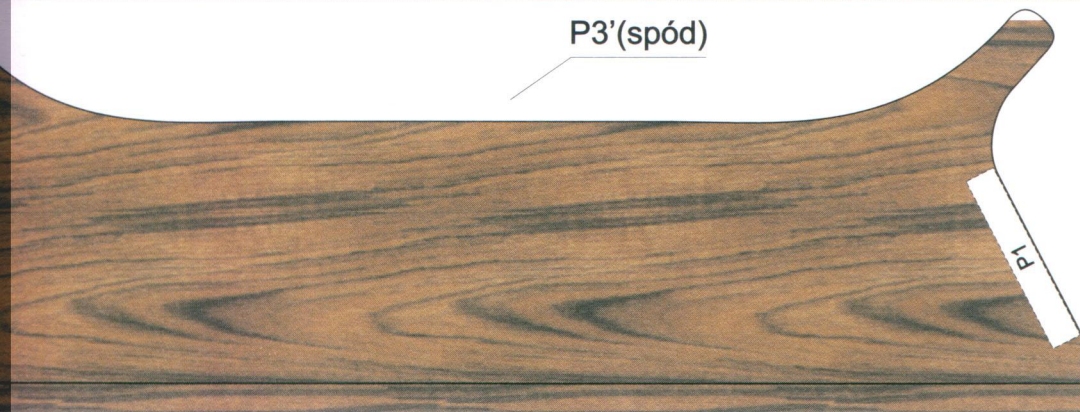

P3'(spód)

Szablony pokrowców na działa 380mm:

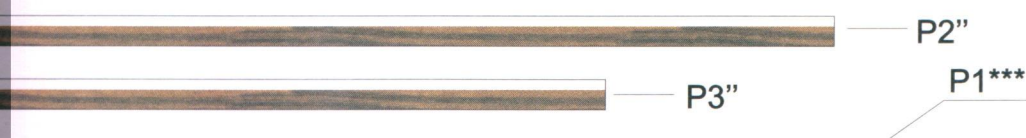

P2''

P3''

P1\*\*\*

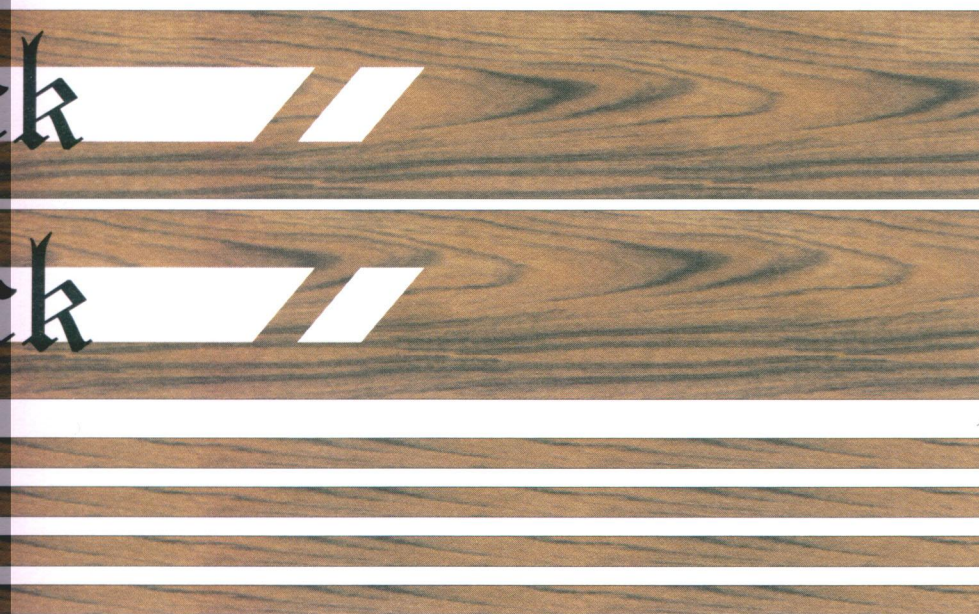

P1'

Szablony pokrowców na działa 150mm:

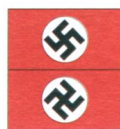
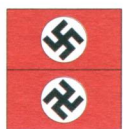
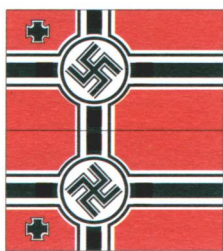
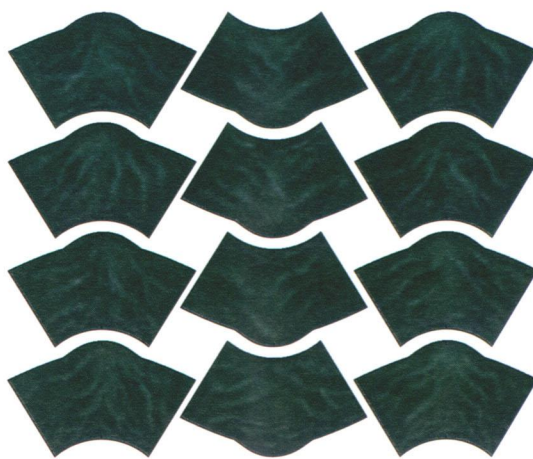



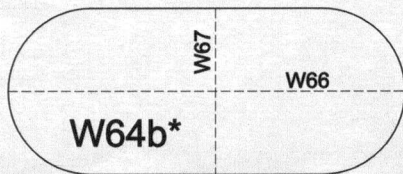
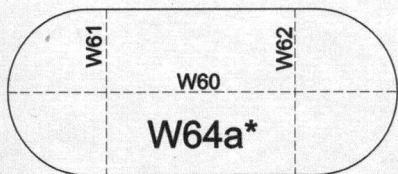
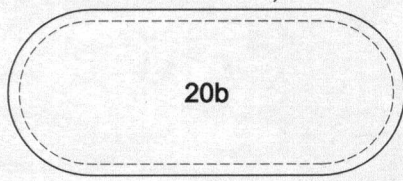
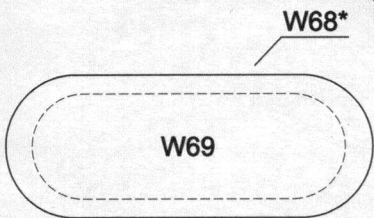
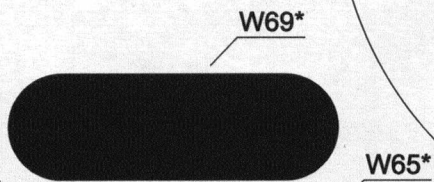
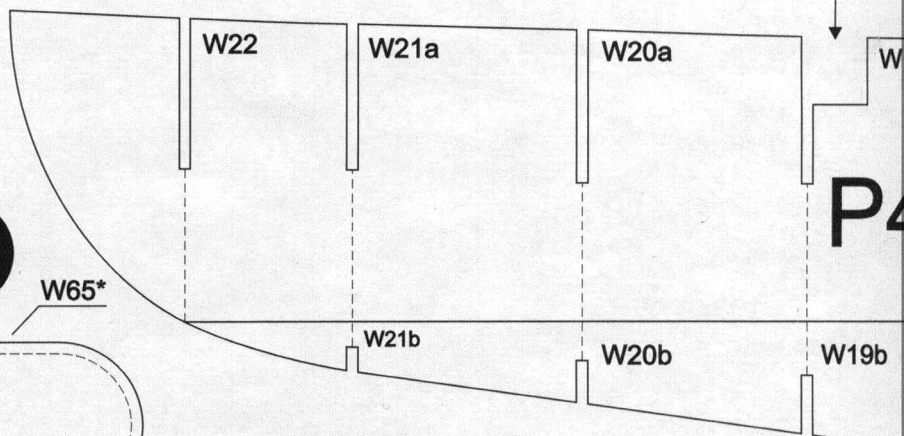
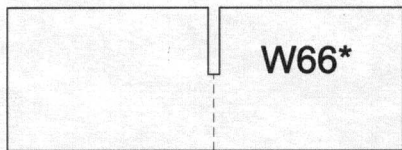
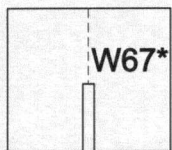
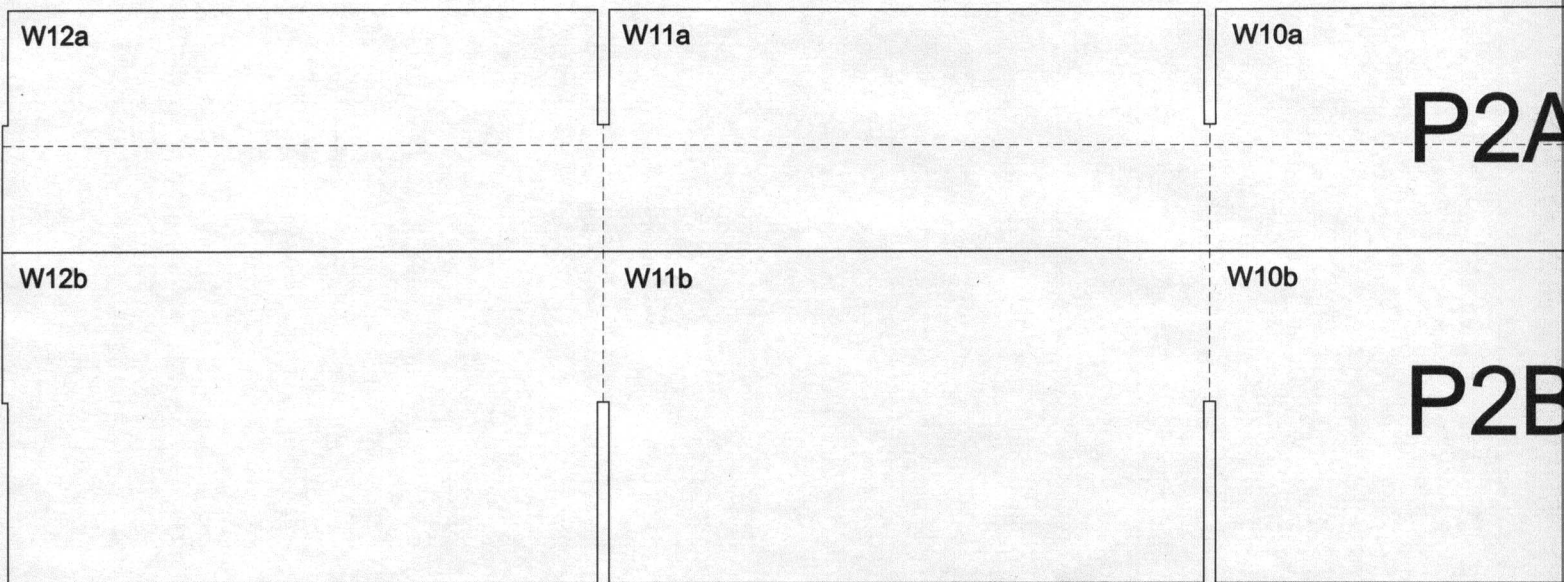
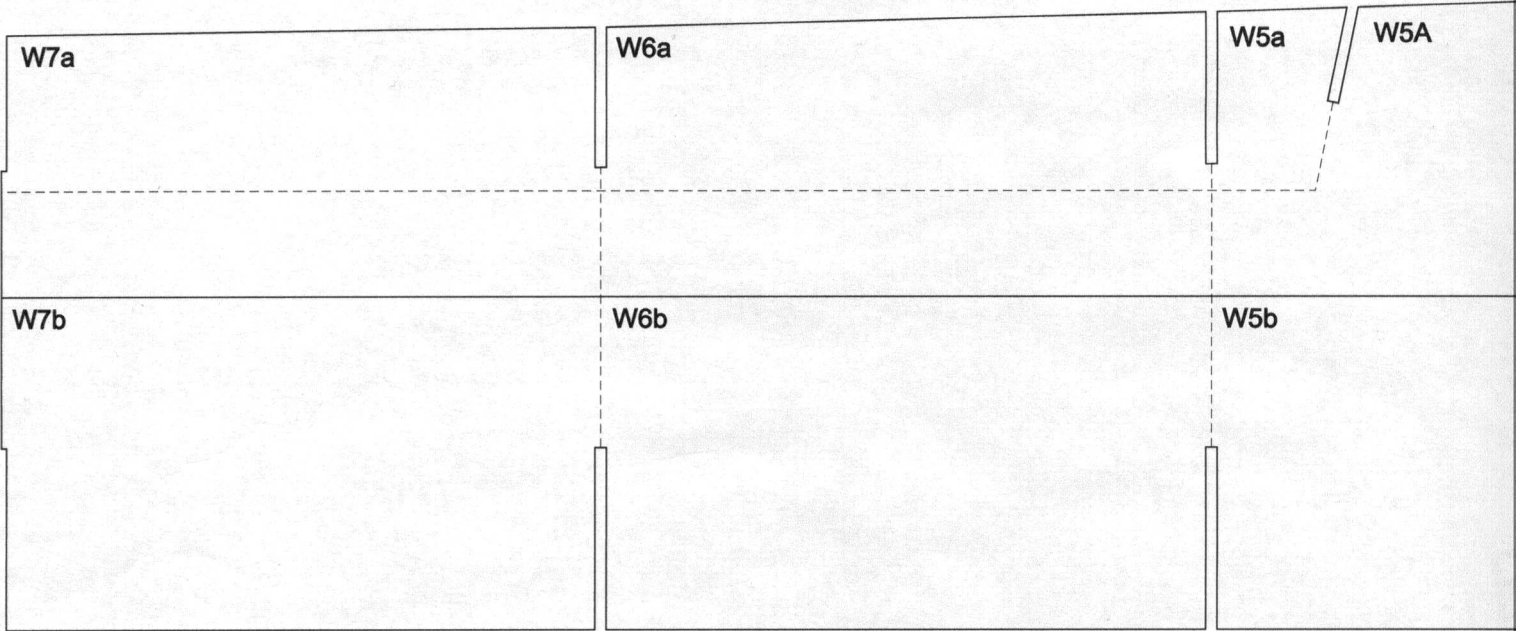

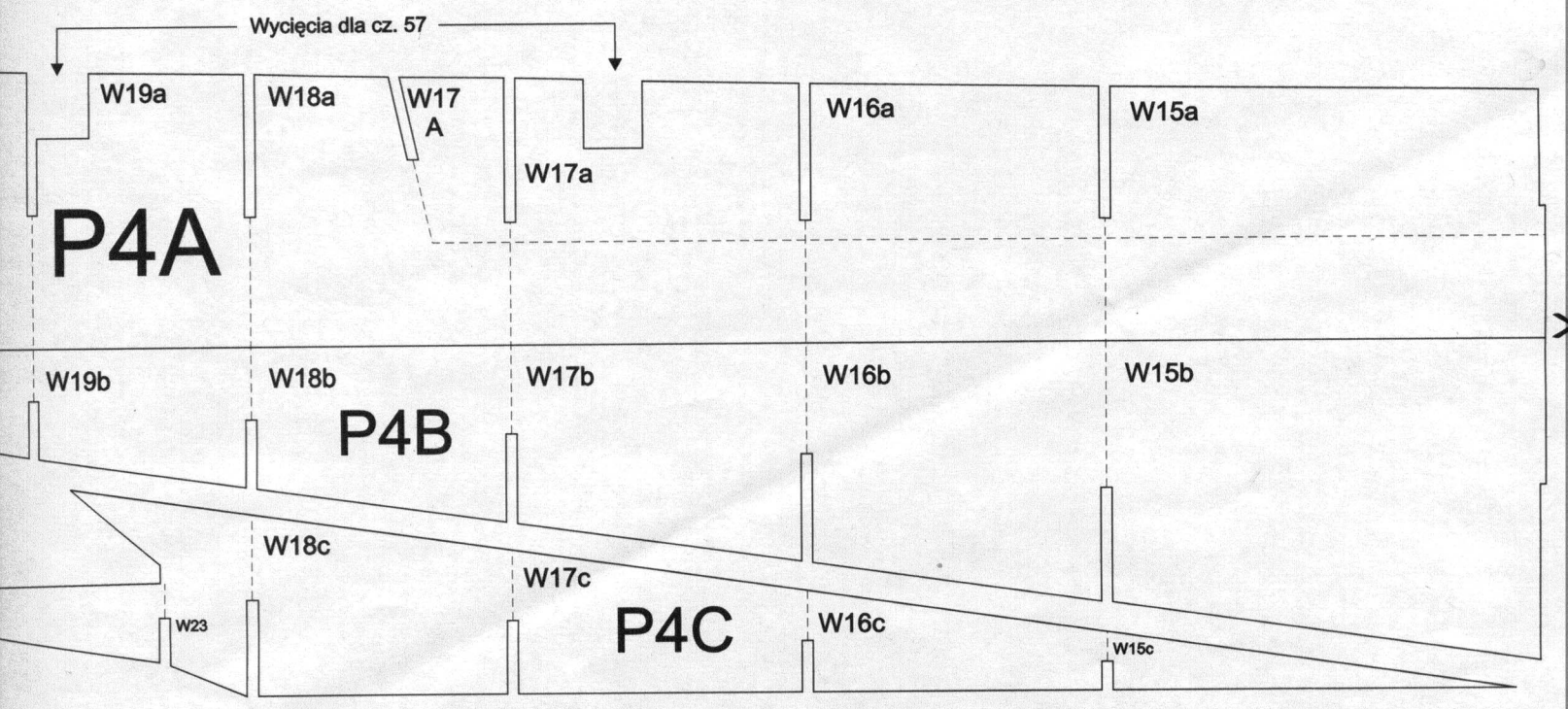
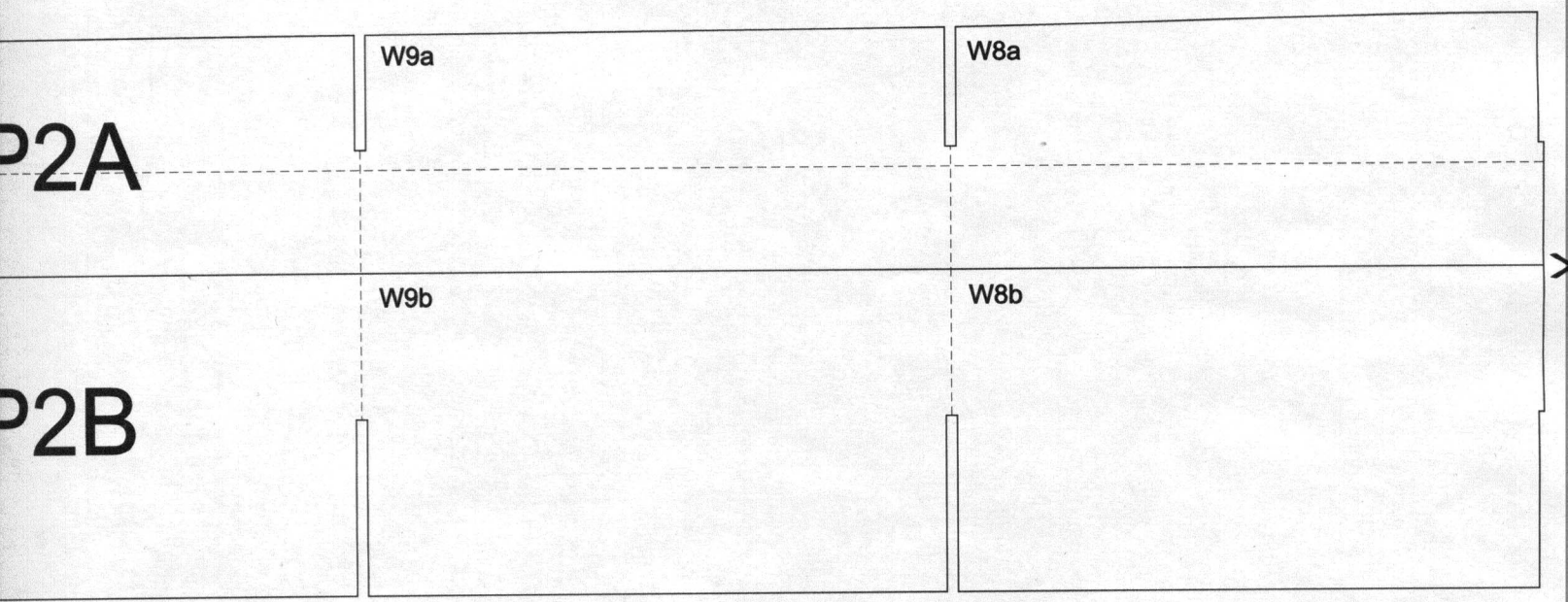
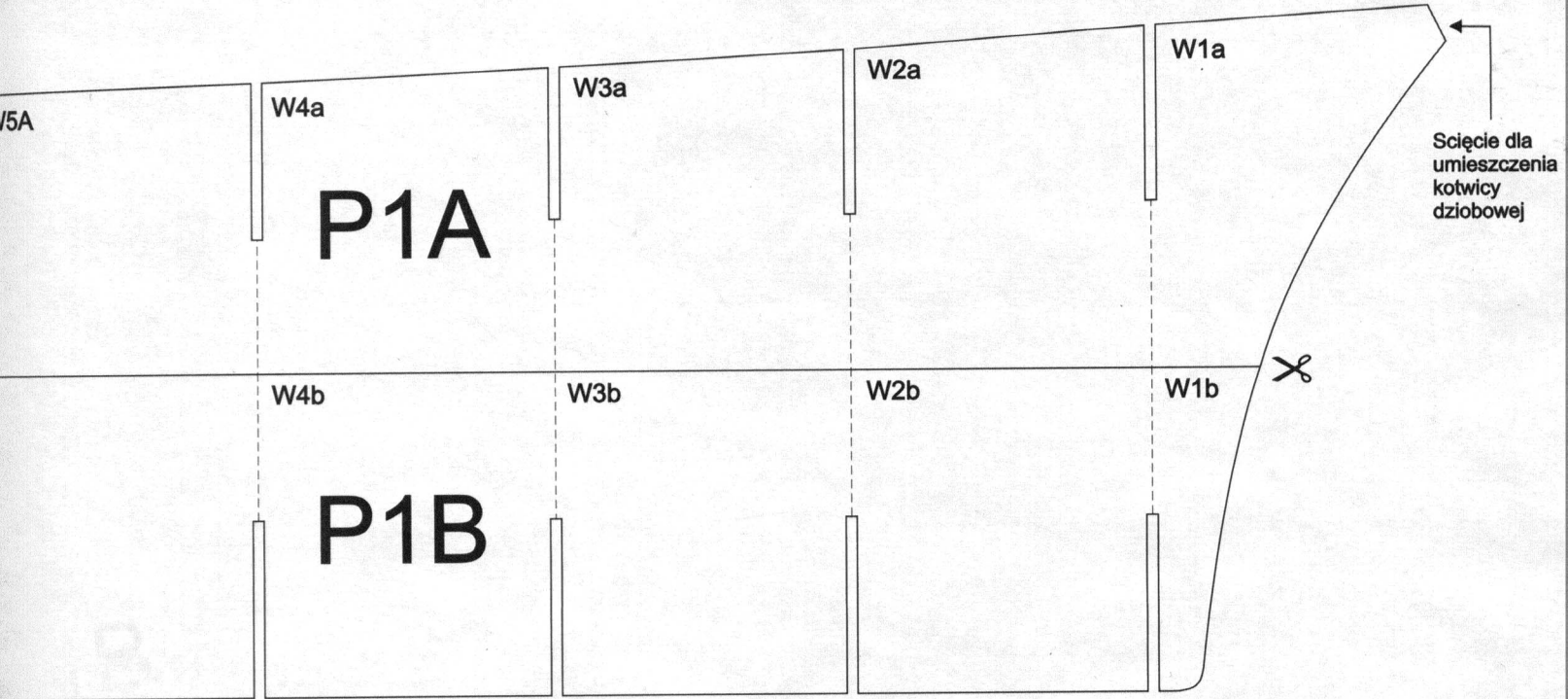

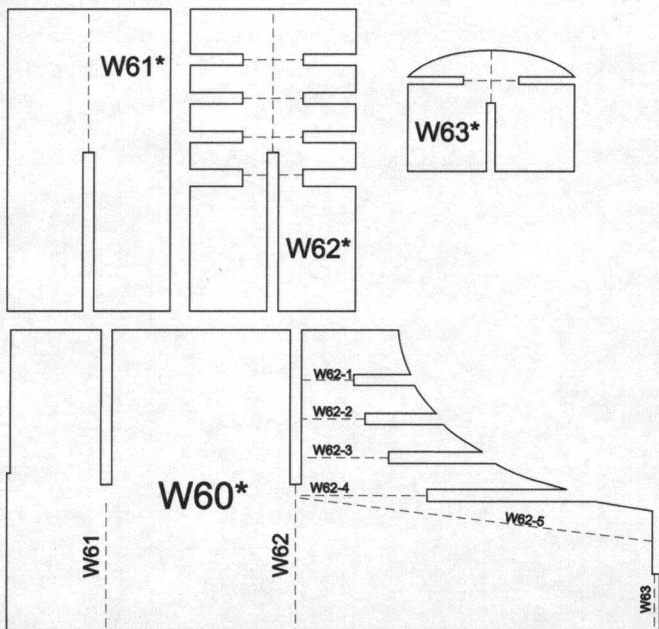
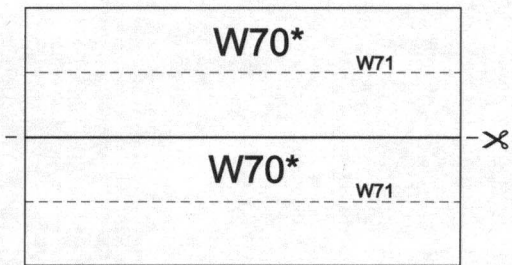
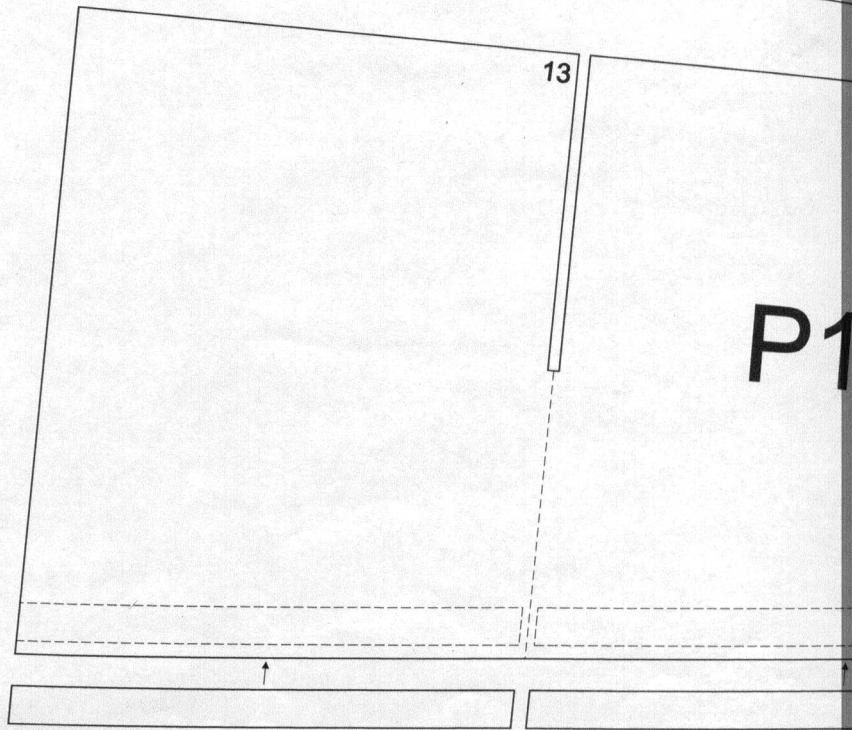
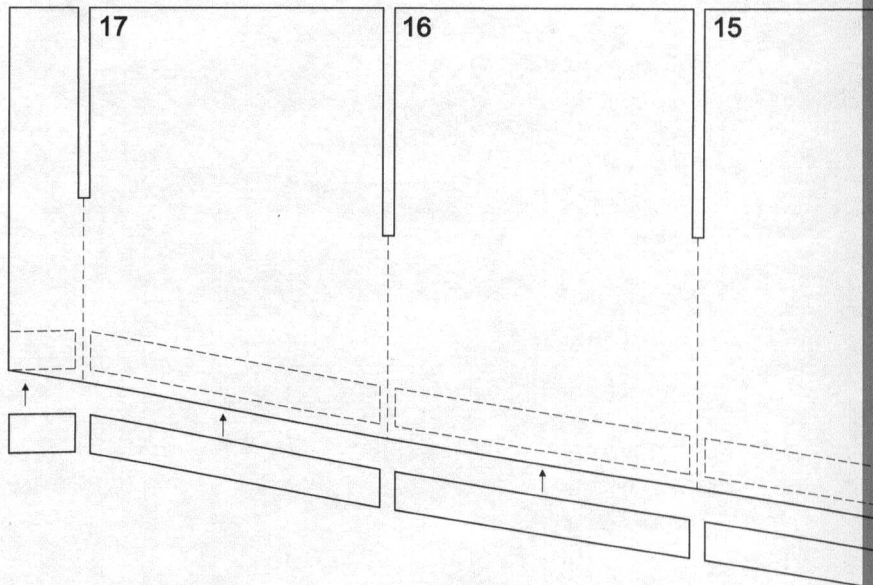
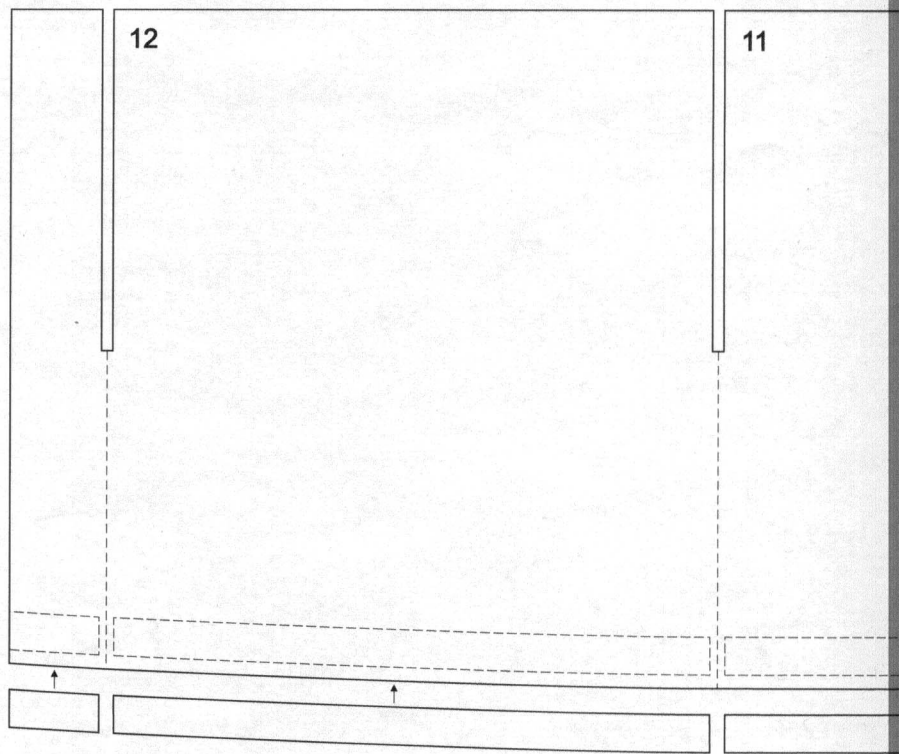
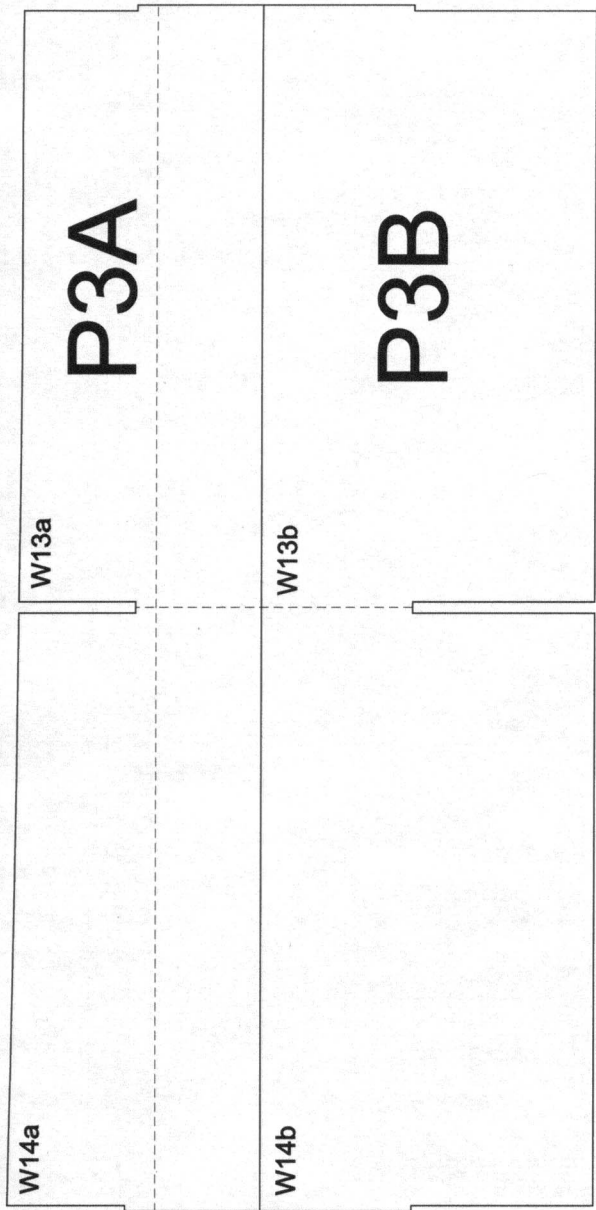

P9P

10

9

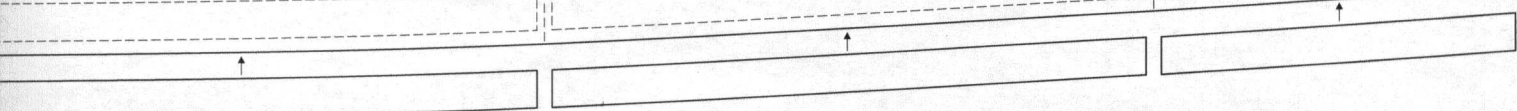

P10P

14

13

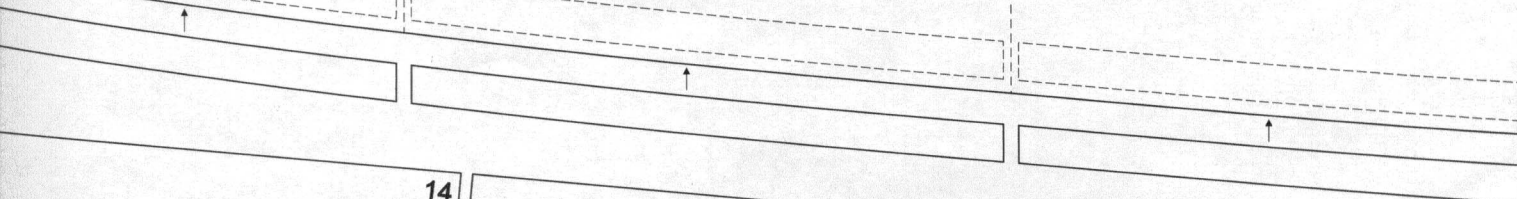

P10L

14

15

16

17

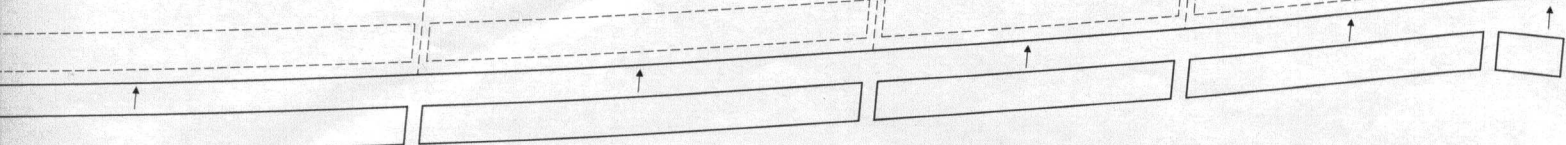

W77\*

W76\*

W76

W77 W74\* W78

W29\*

W31 W28\*

W30\*

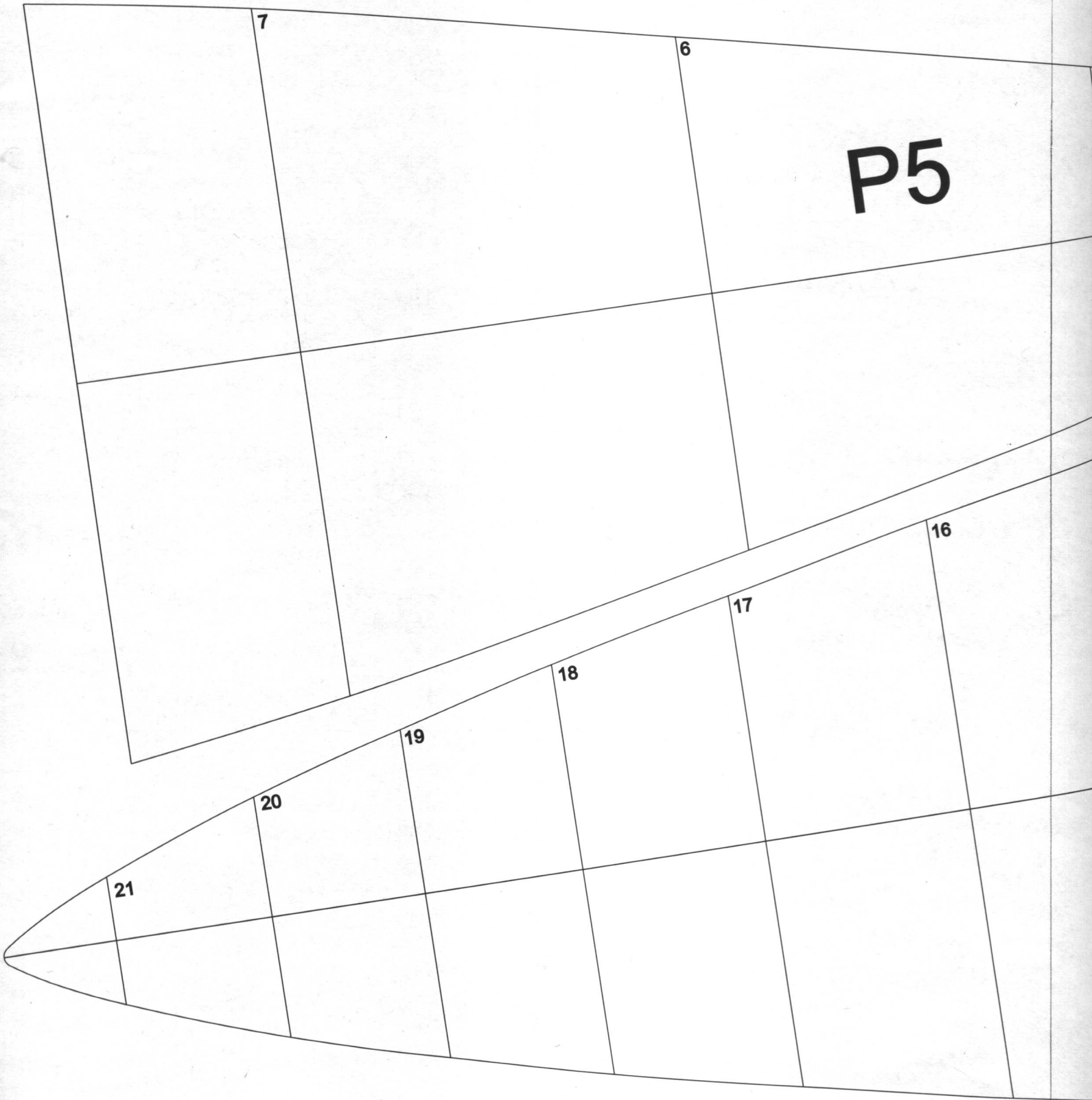

W76\*

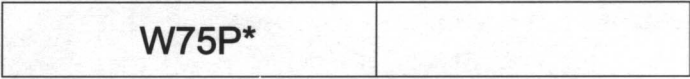
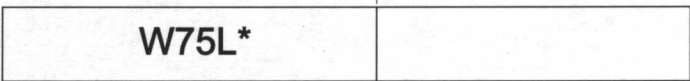
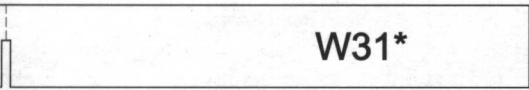
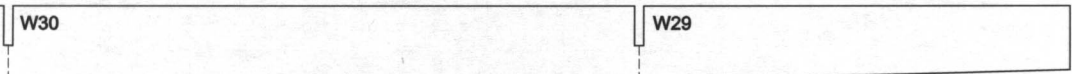
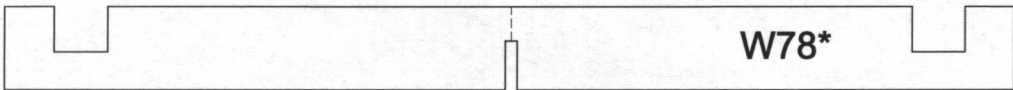

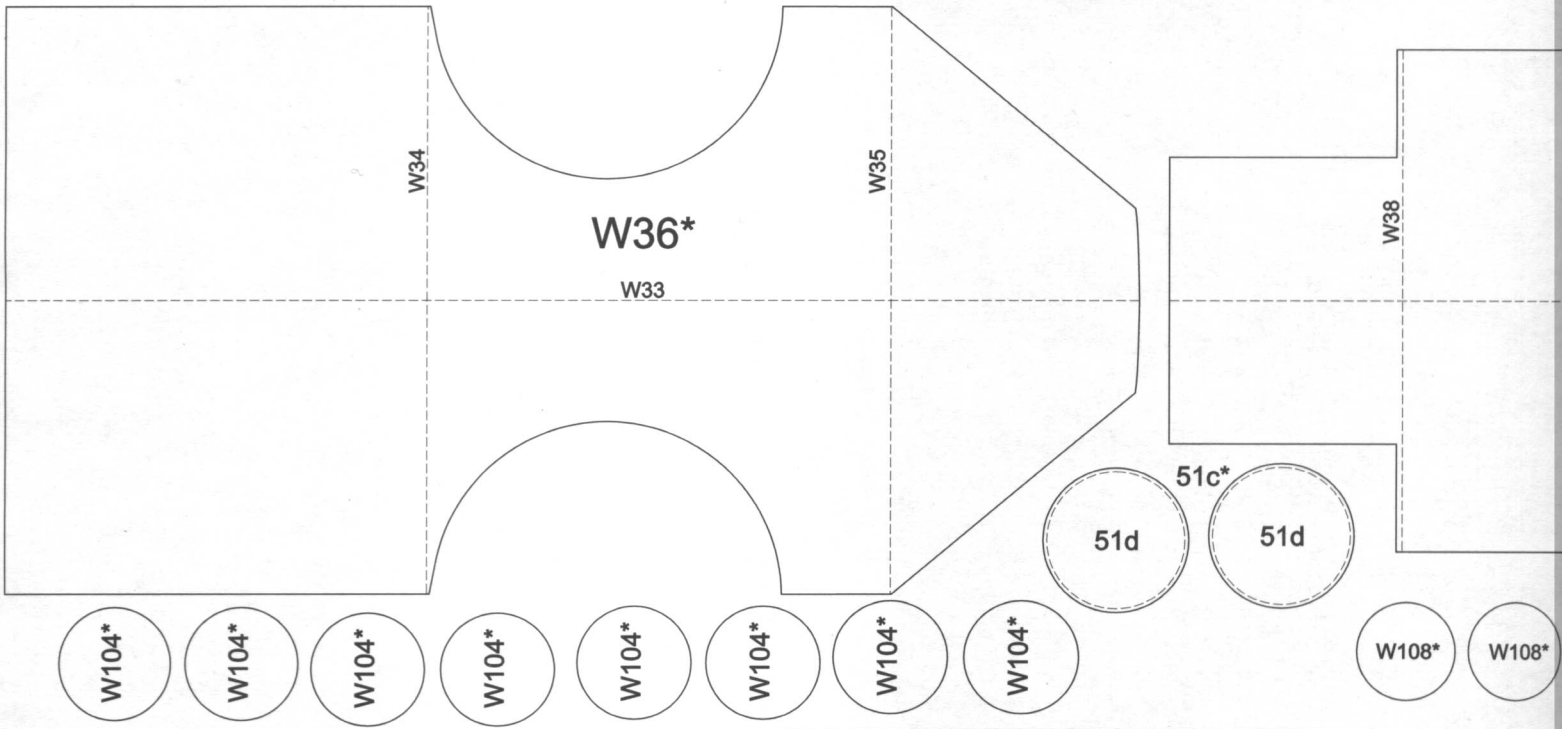

	12	11

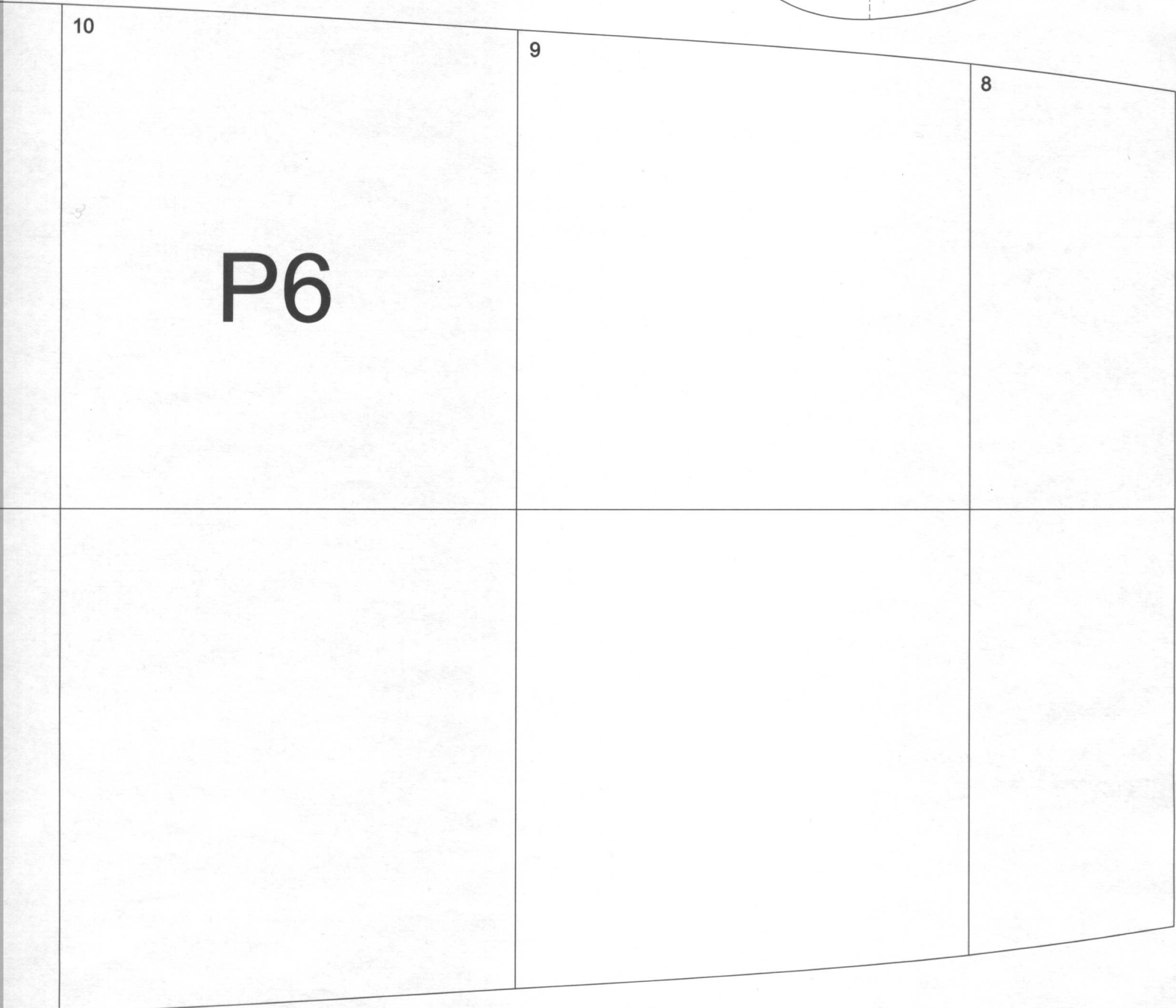
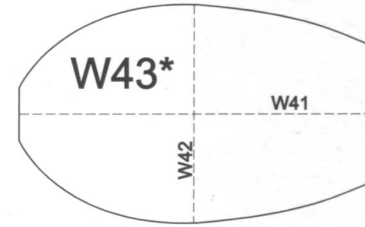
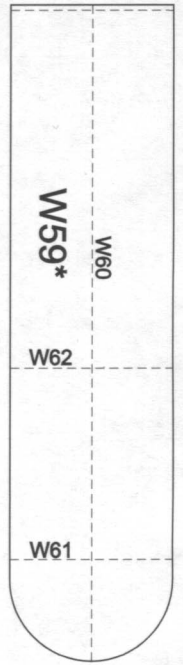
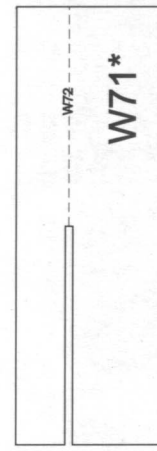
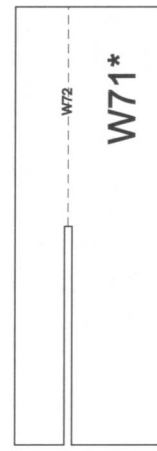
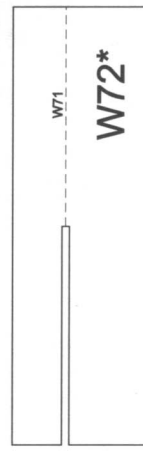
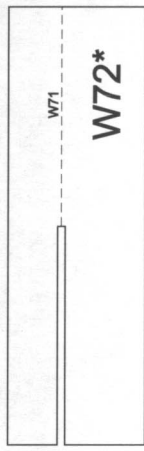
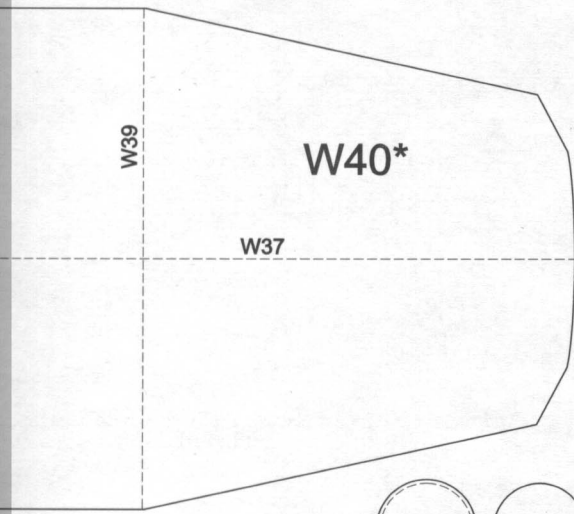



W38

W39

W37\*

W38\*

W39\*

W51\*

W52\*

W41\*

W42\*

W48\*

W49\*

P9L

12

11

10

8

7

6

P8P

7

6

5

P8L

