

KARTONOWE
ABC 2'98

ISSN 1428 - 4618

АНДРЕЙ ПЕРВОЗВАННЫЙ

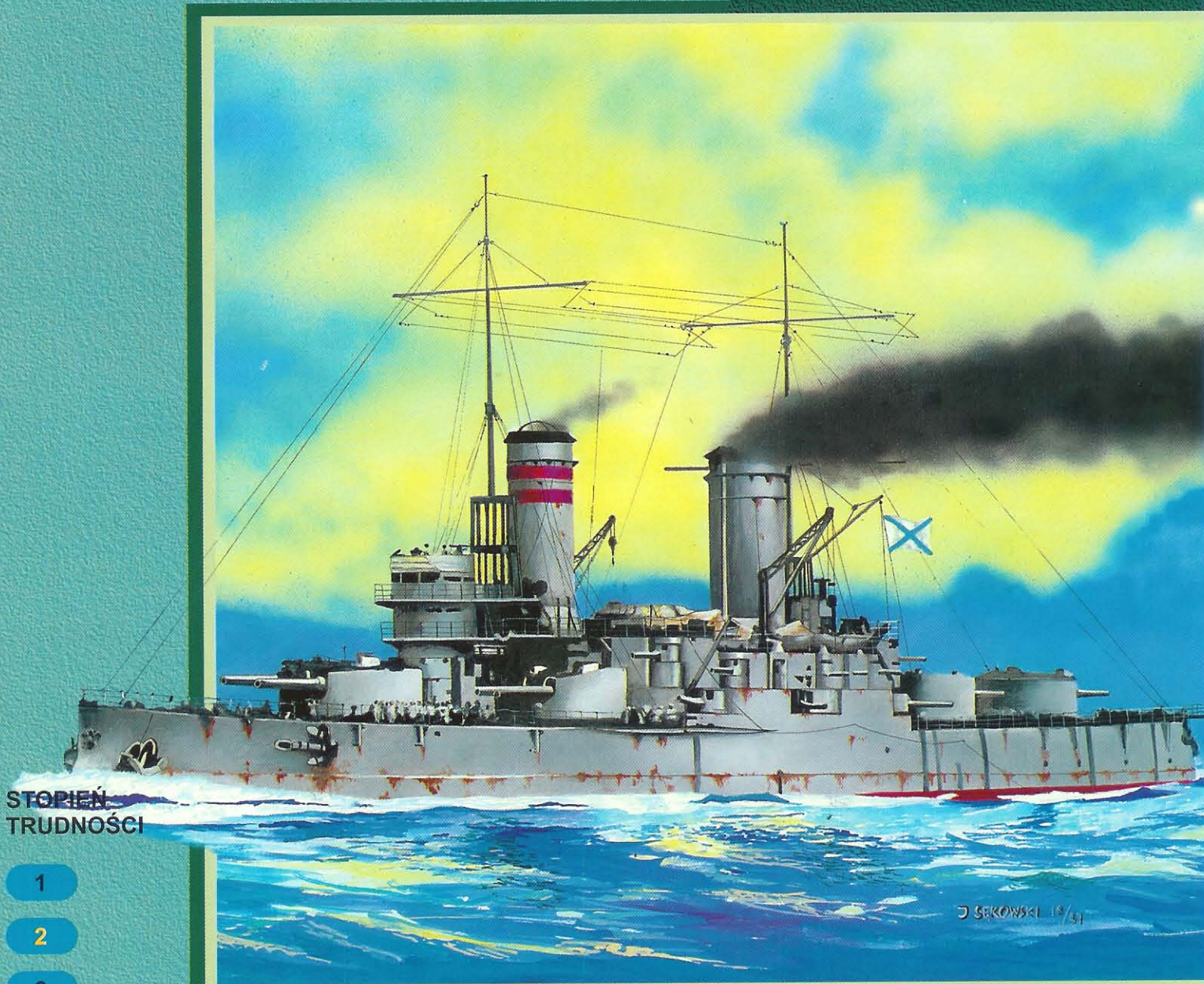

STOPIEŃ
TRUDNOŚCI

1

2

3

WYMIARY MODELU

DŁUGOŚĆ 71 cm

SZEROKOŚĆ 12 cm

WYSOKOŚĆ 30 cm

skala 1:200

GPM

NR KAT. **142**

SERIA „**E**”

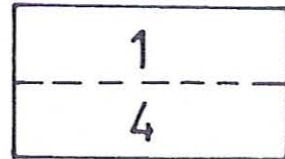
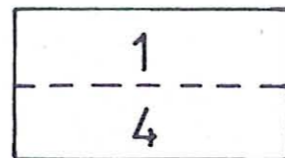
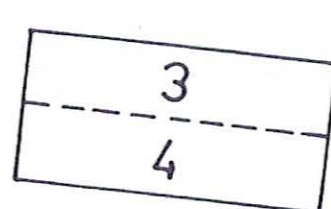
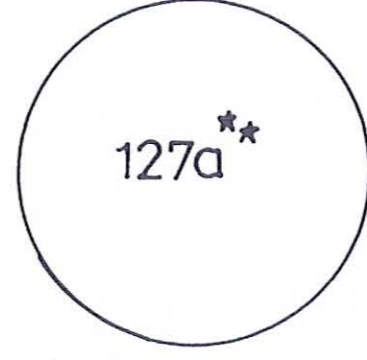
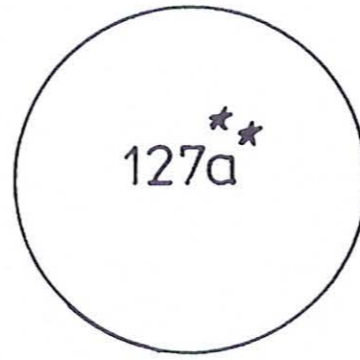
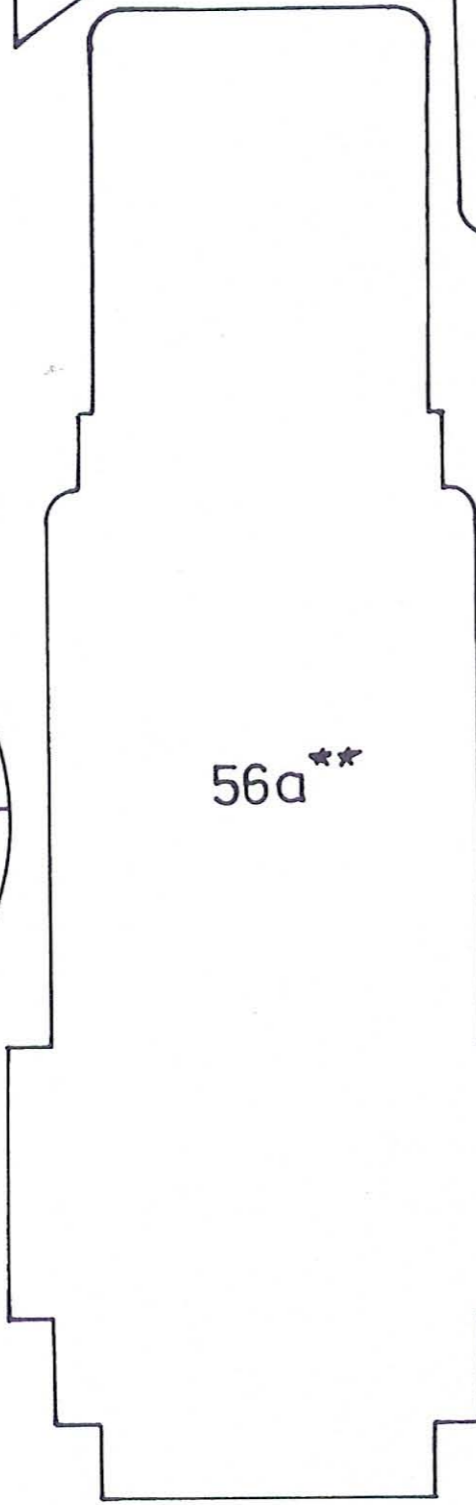
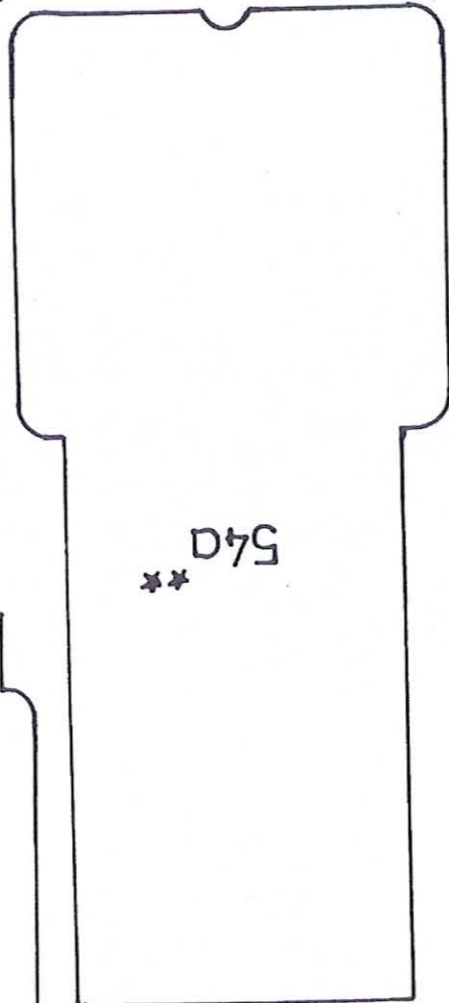
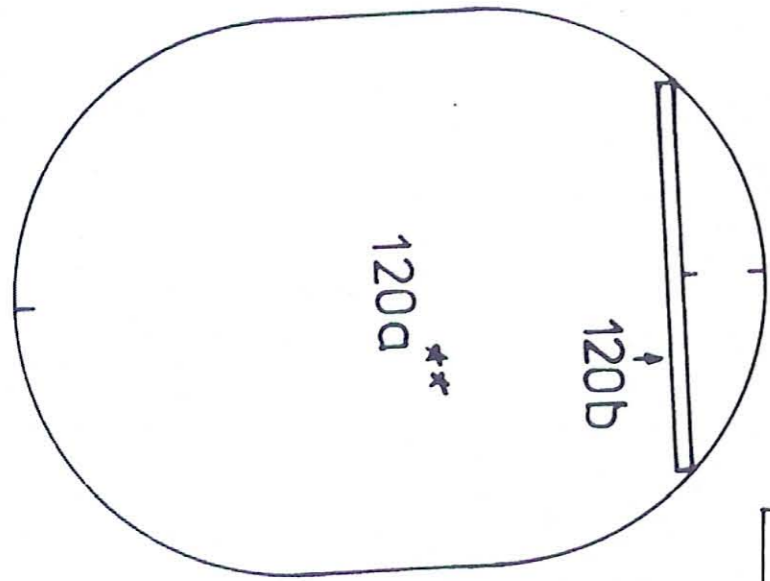
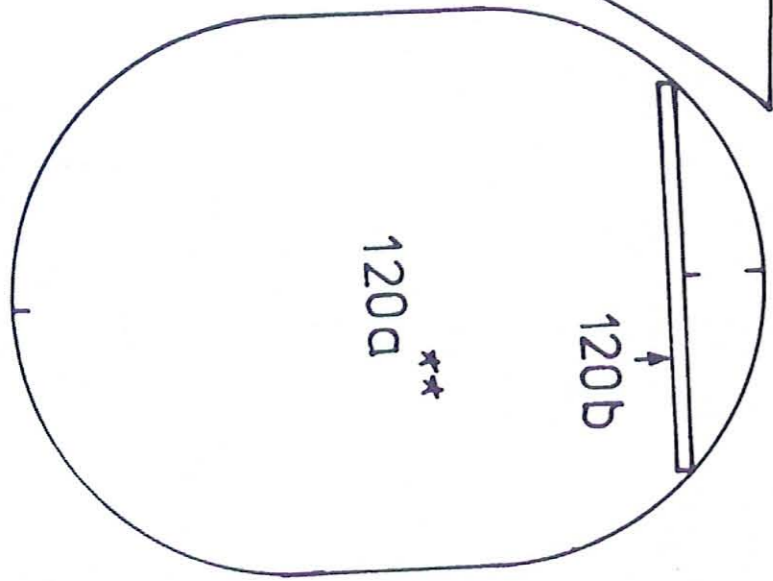
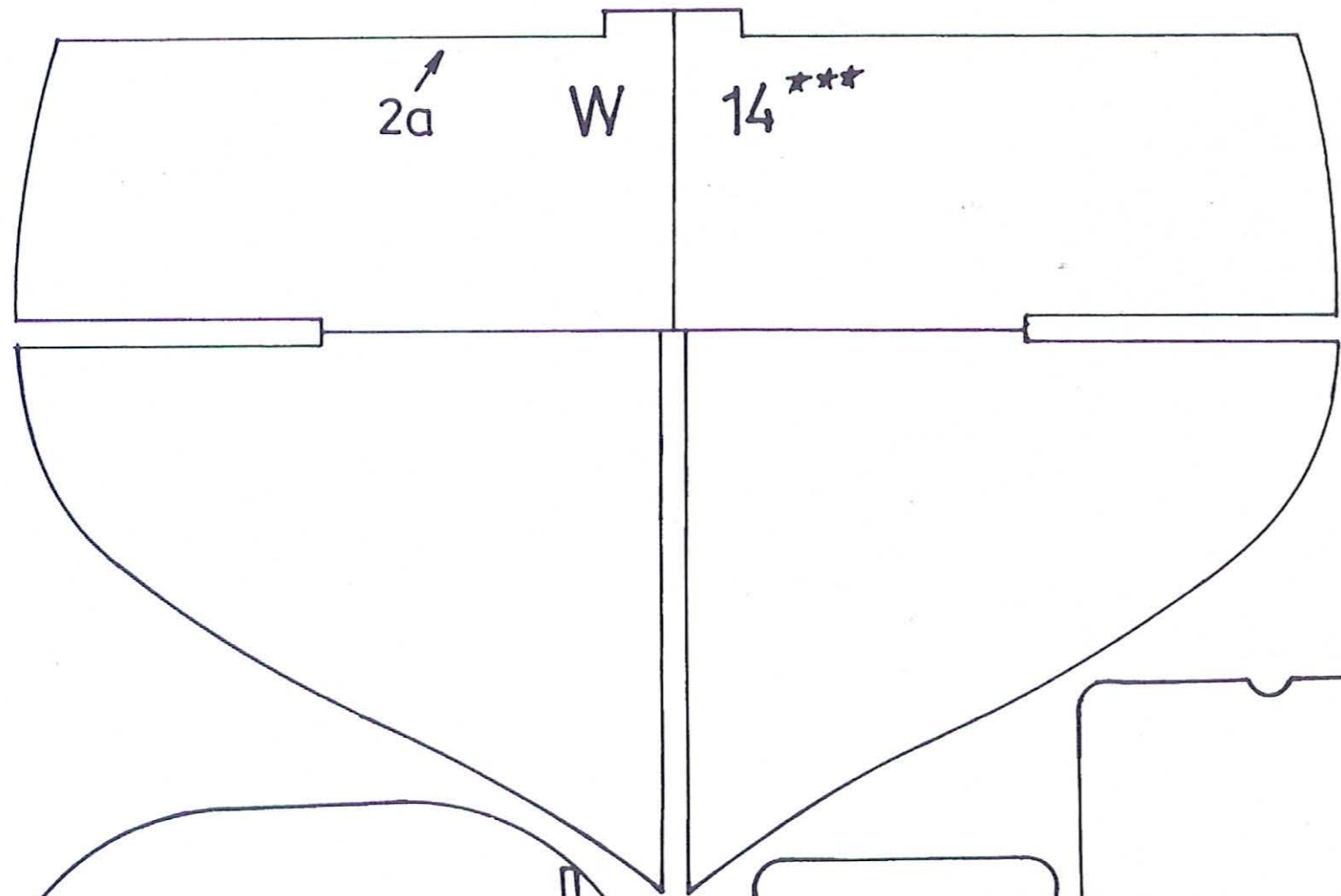

1a**

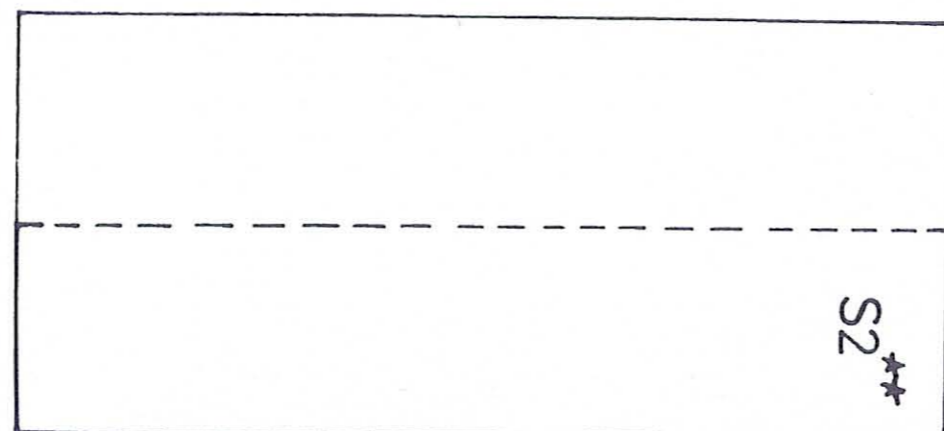
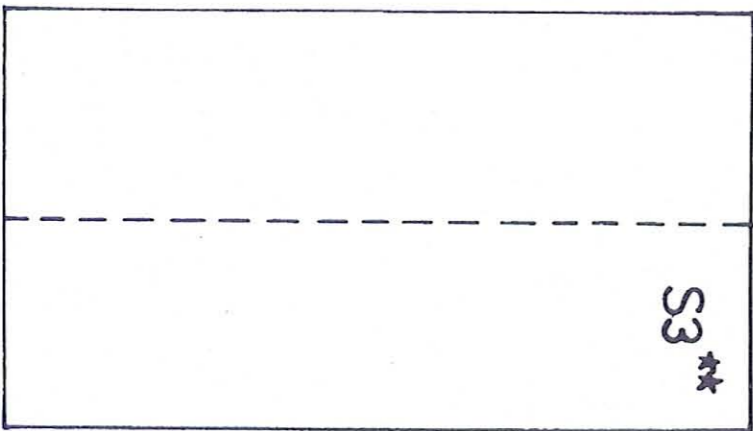
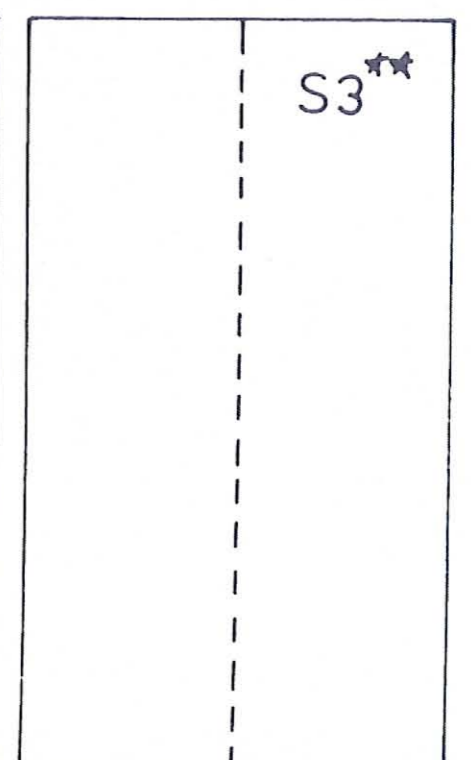
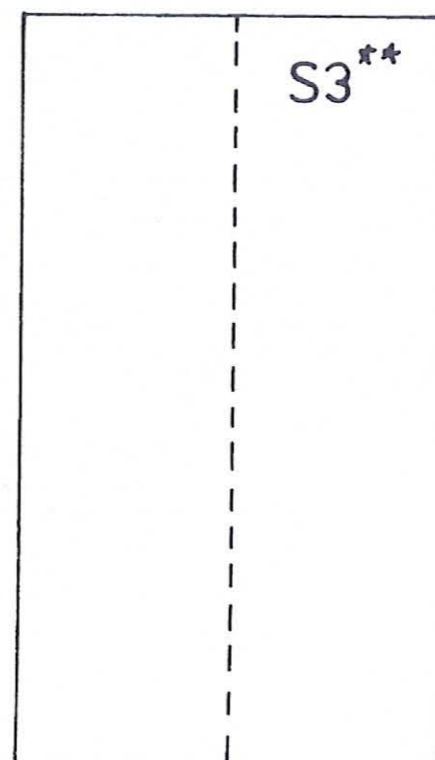
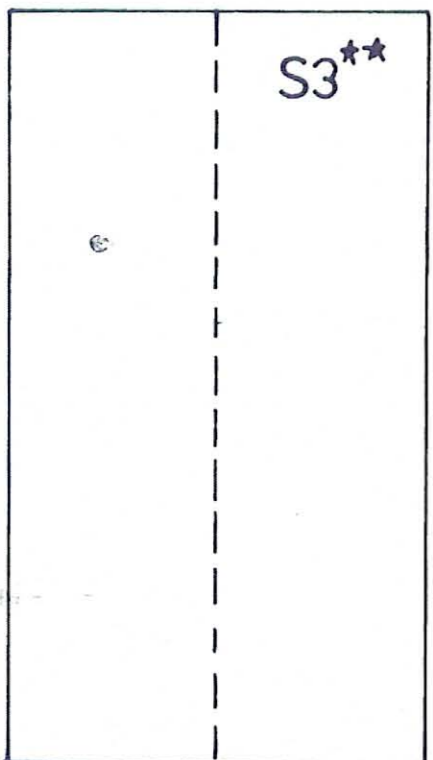
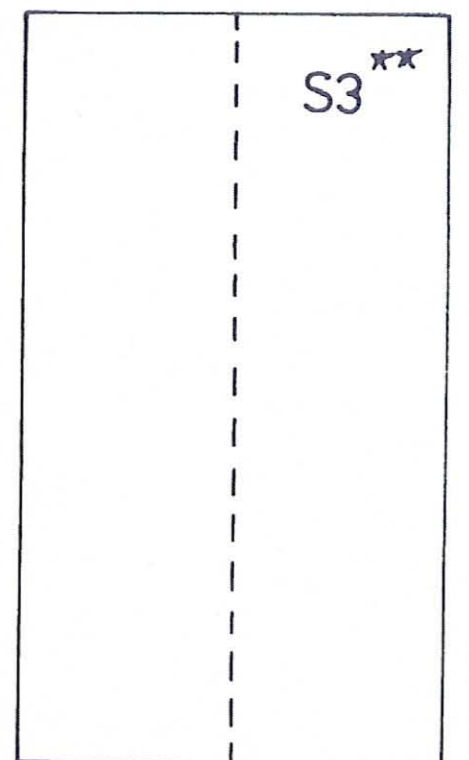
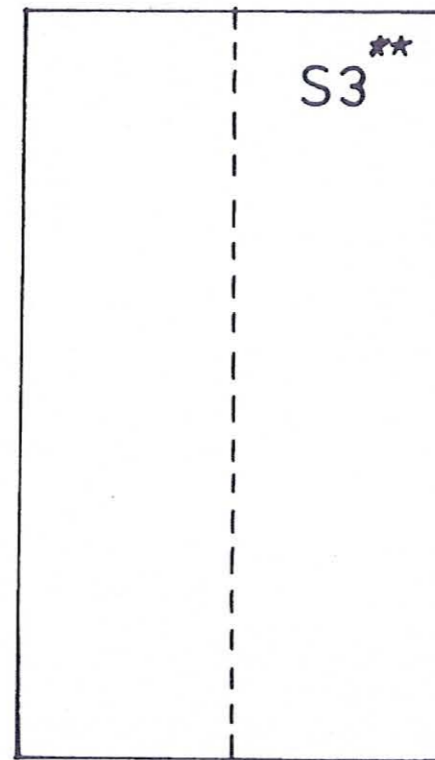
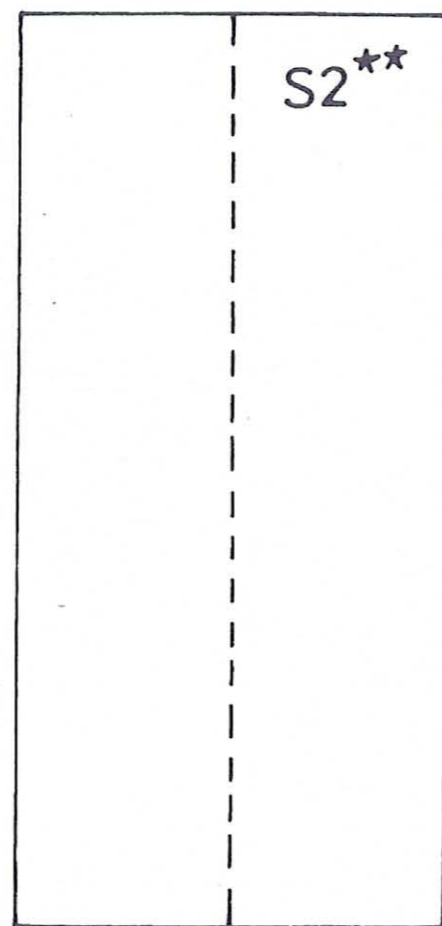
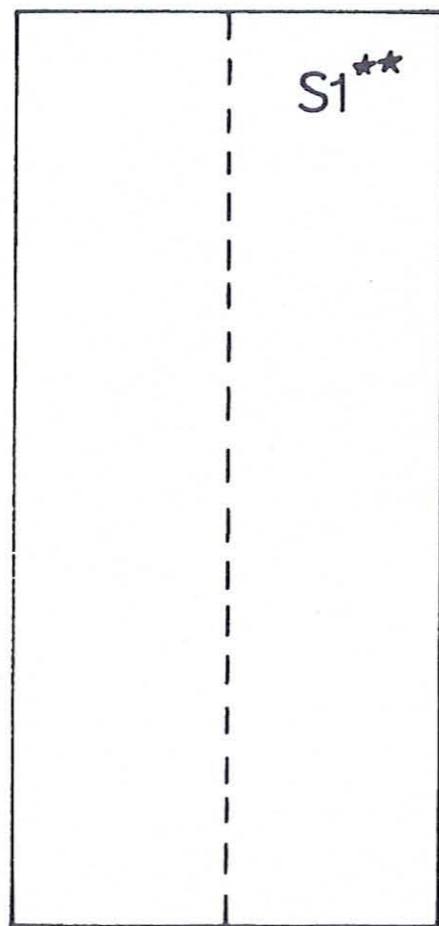
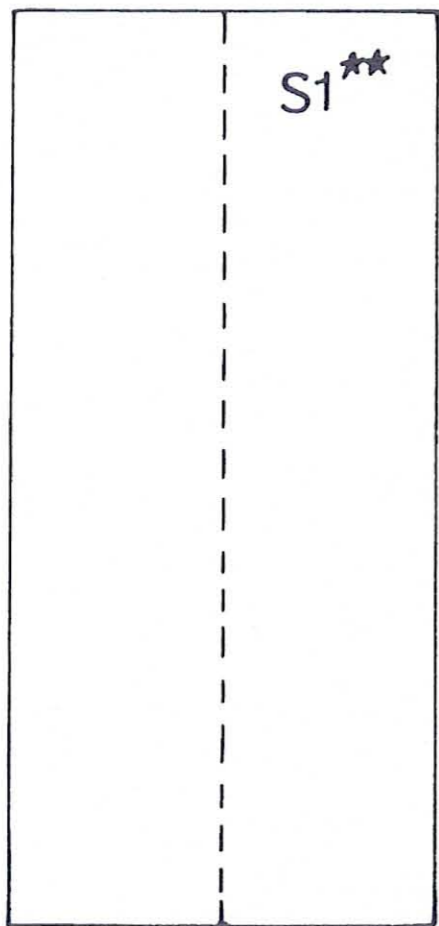
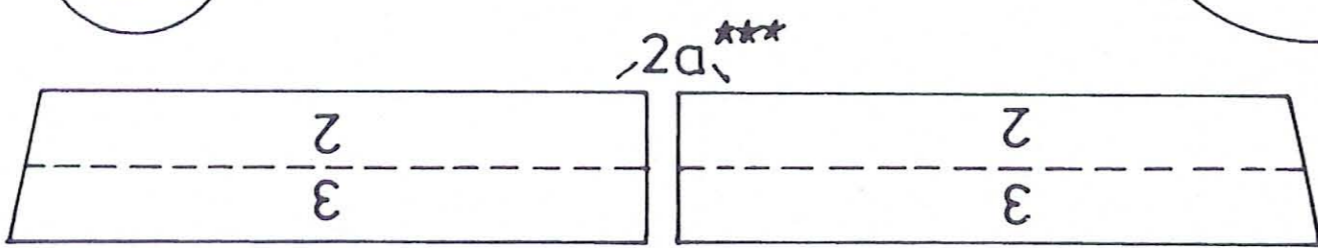
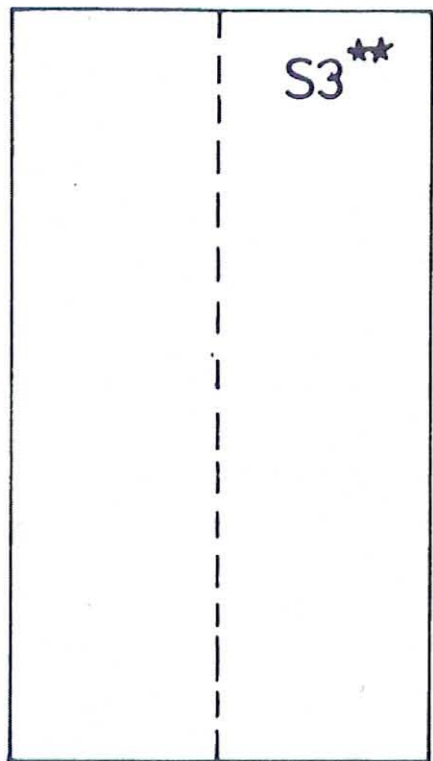
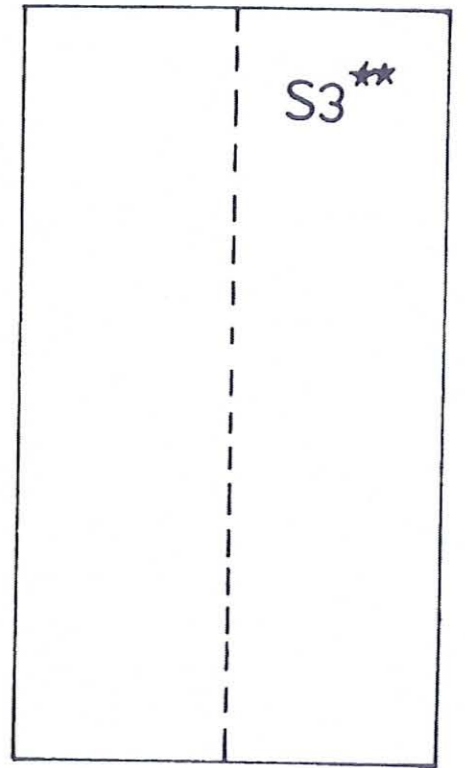
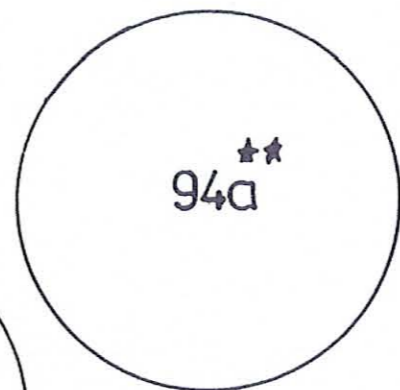
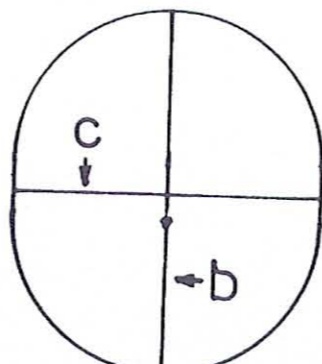
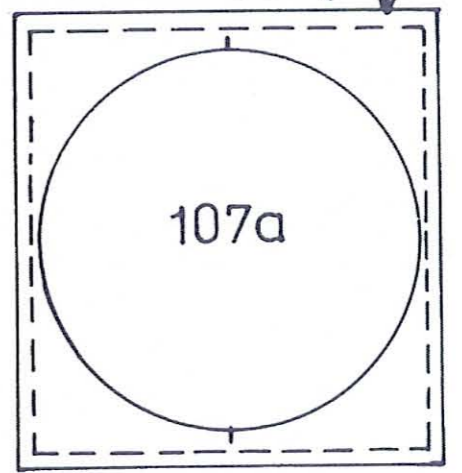
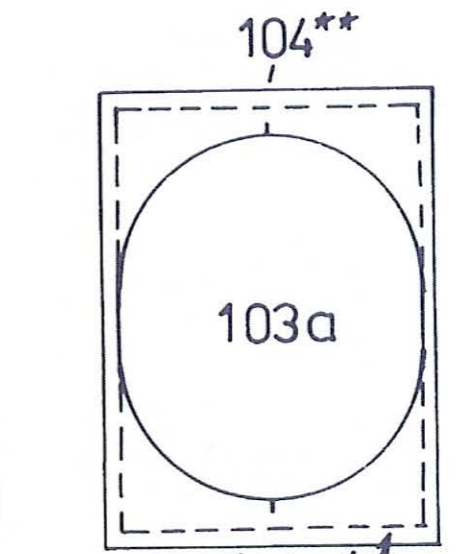

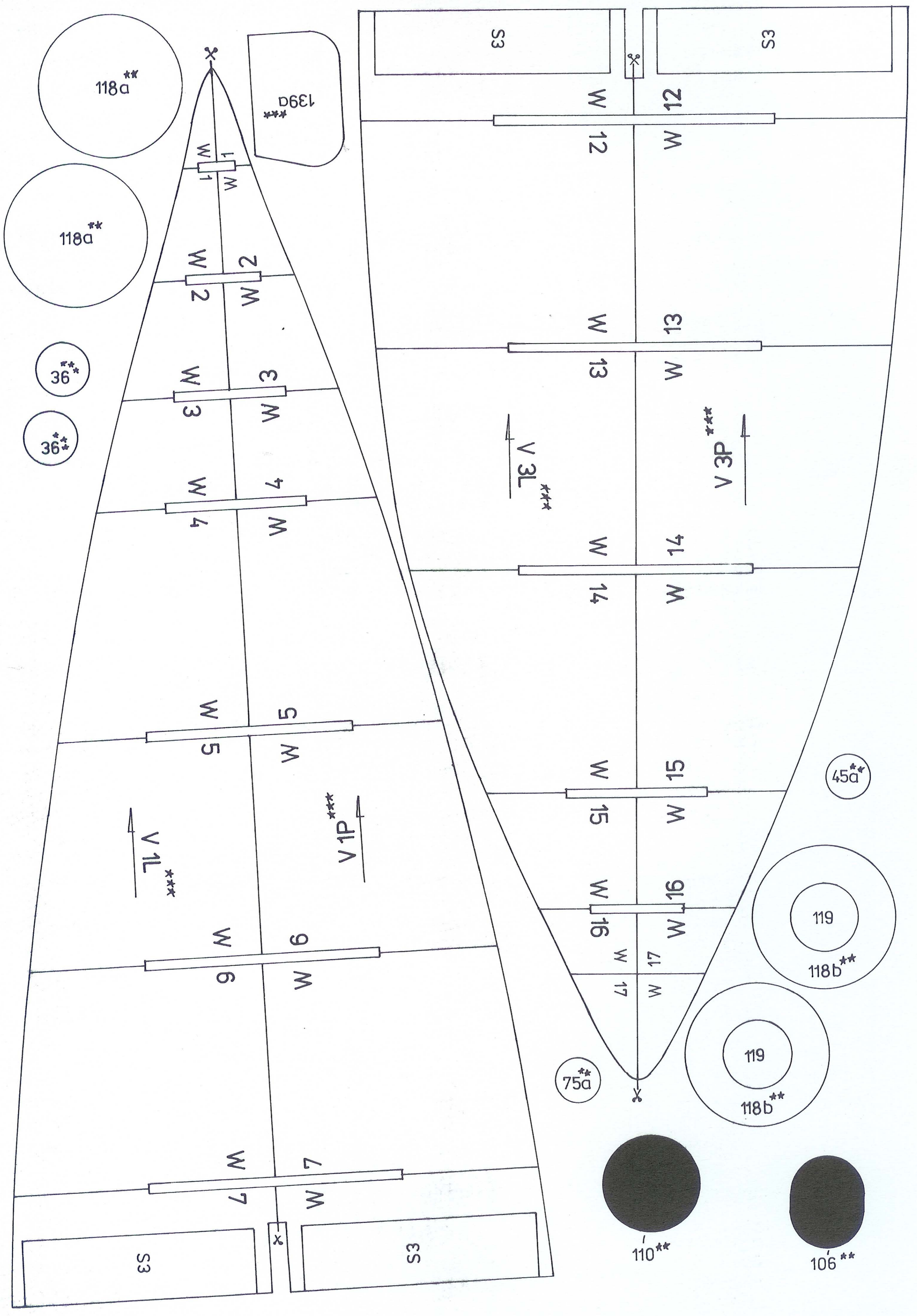

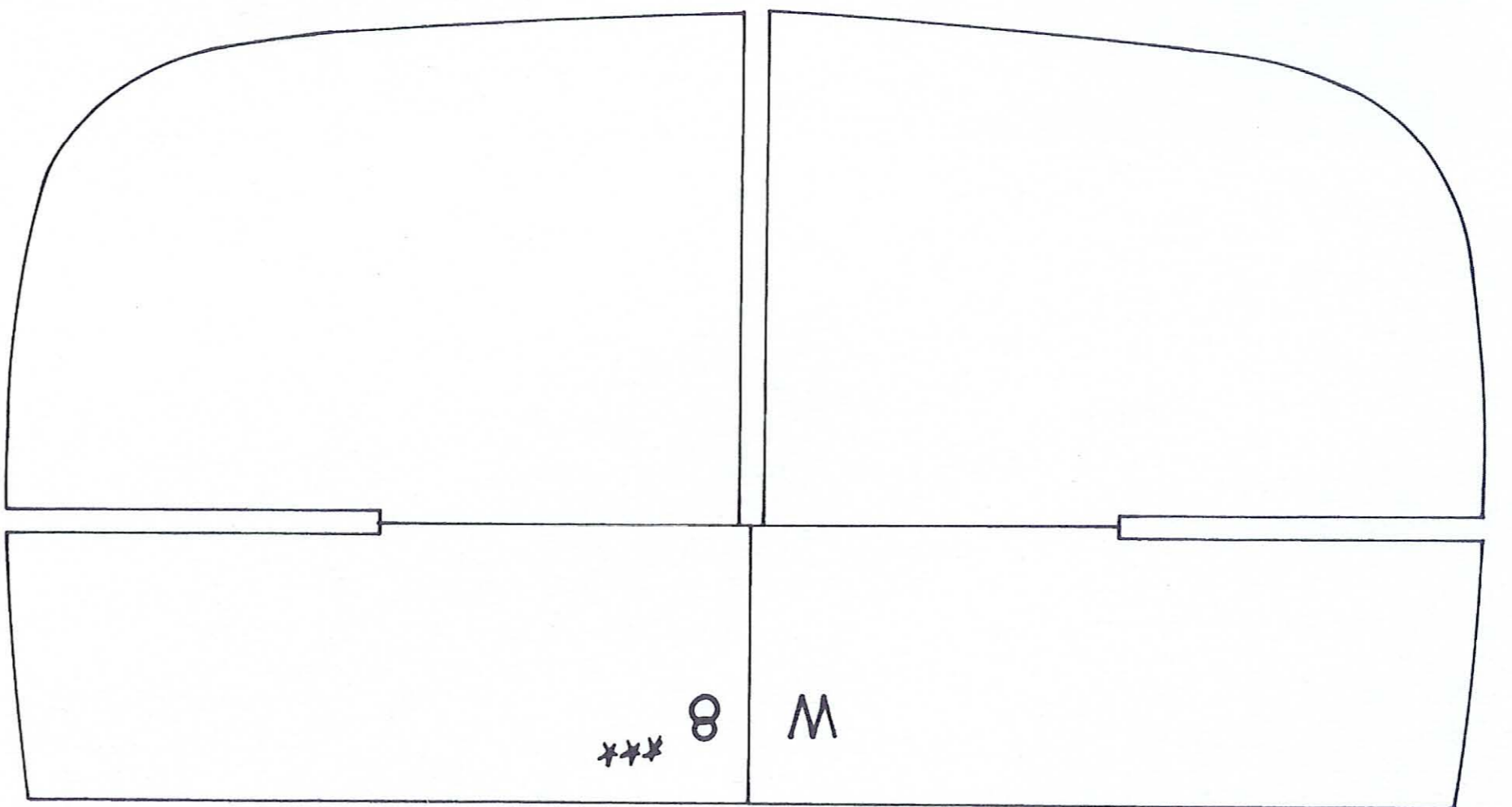
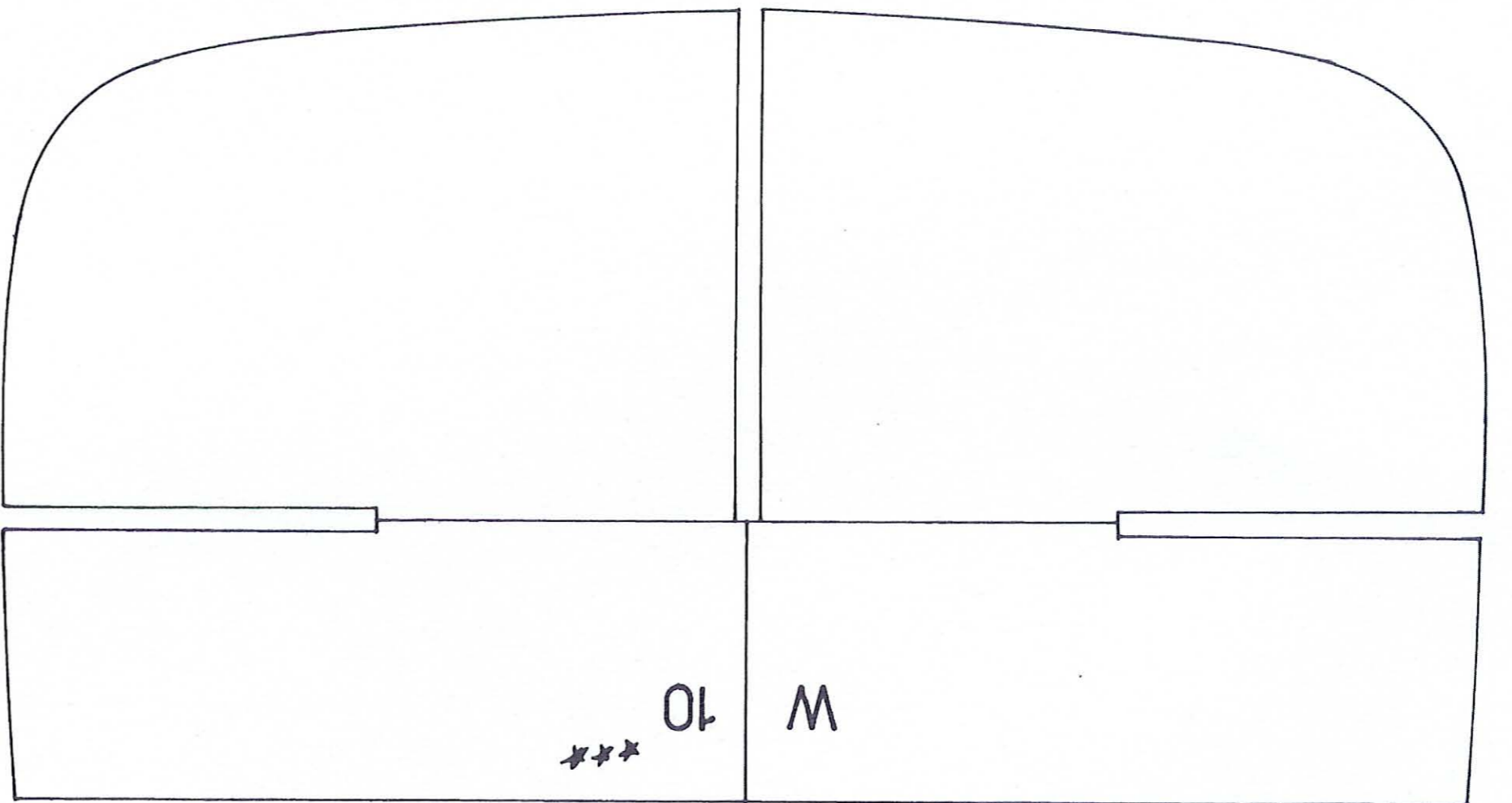
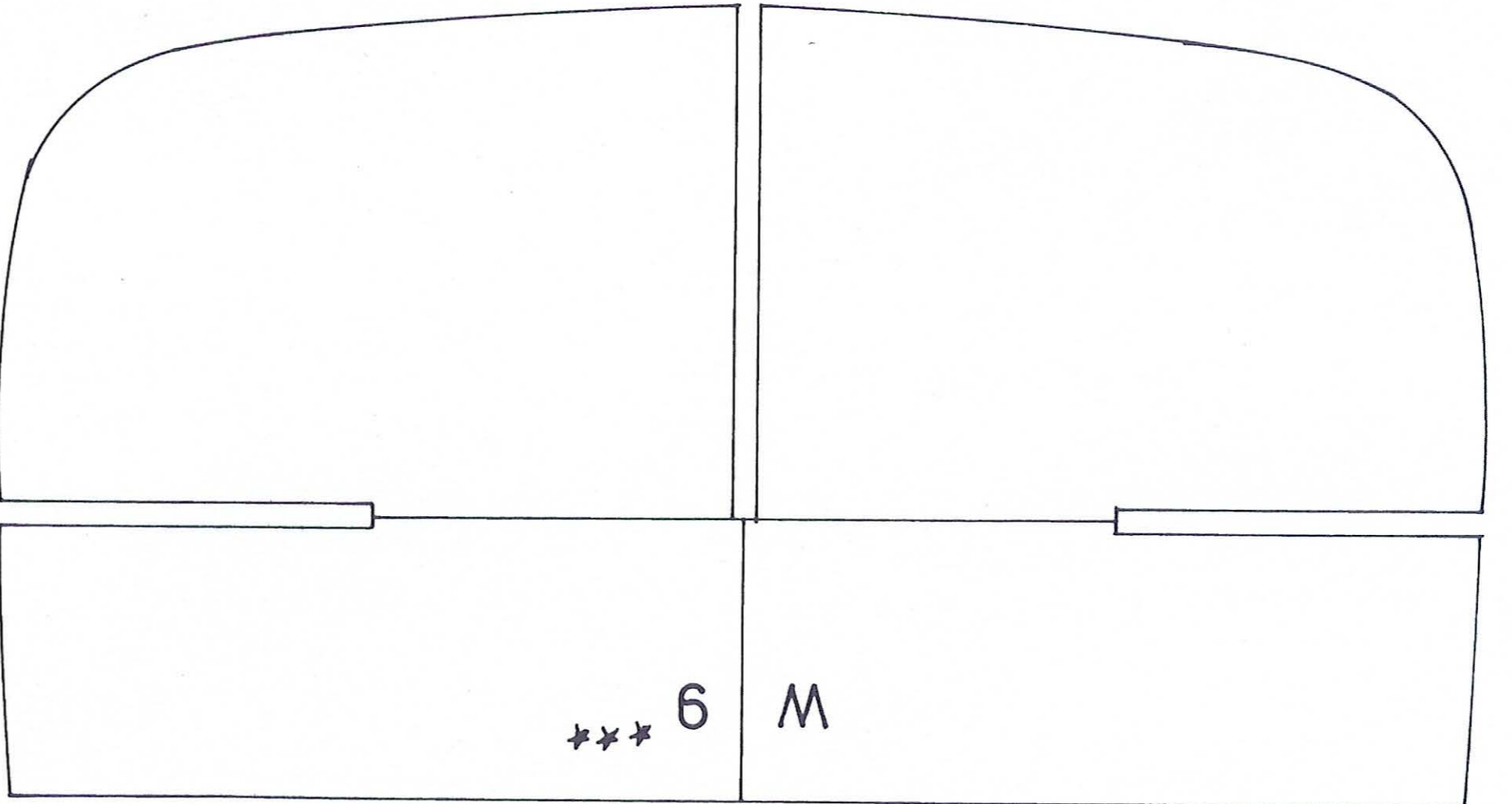
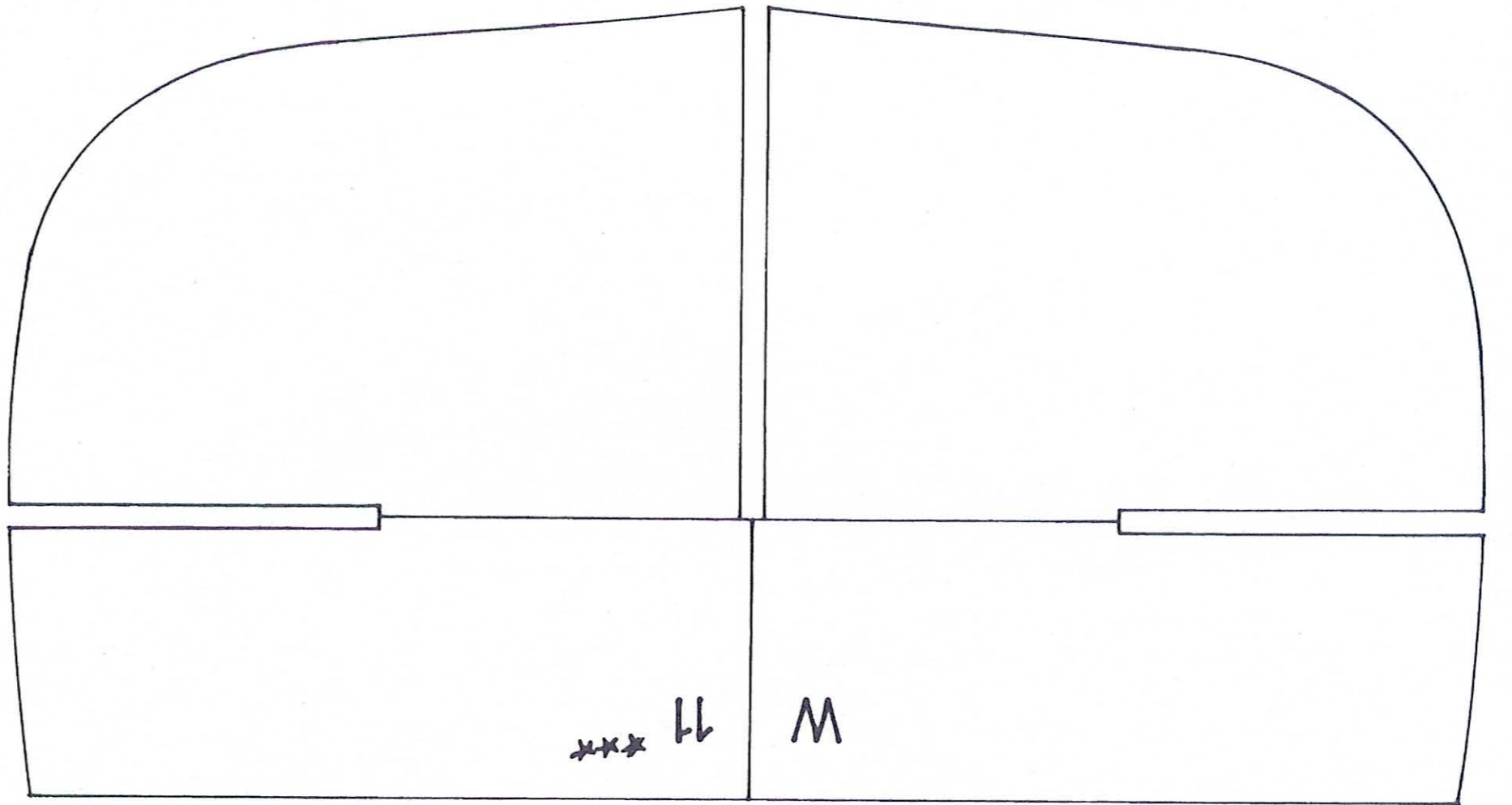
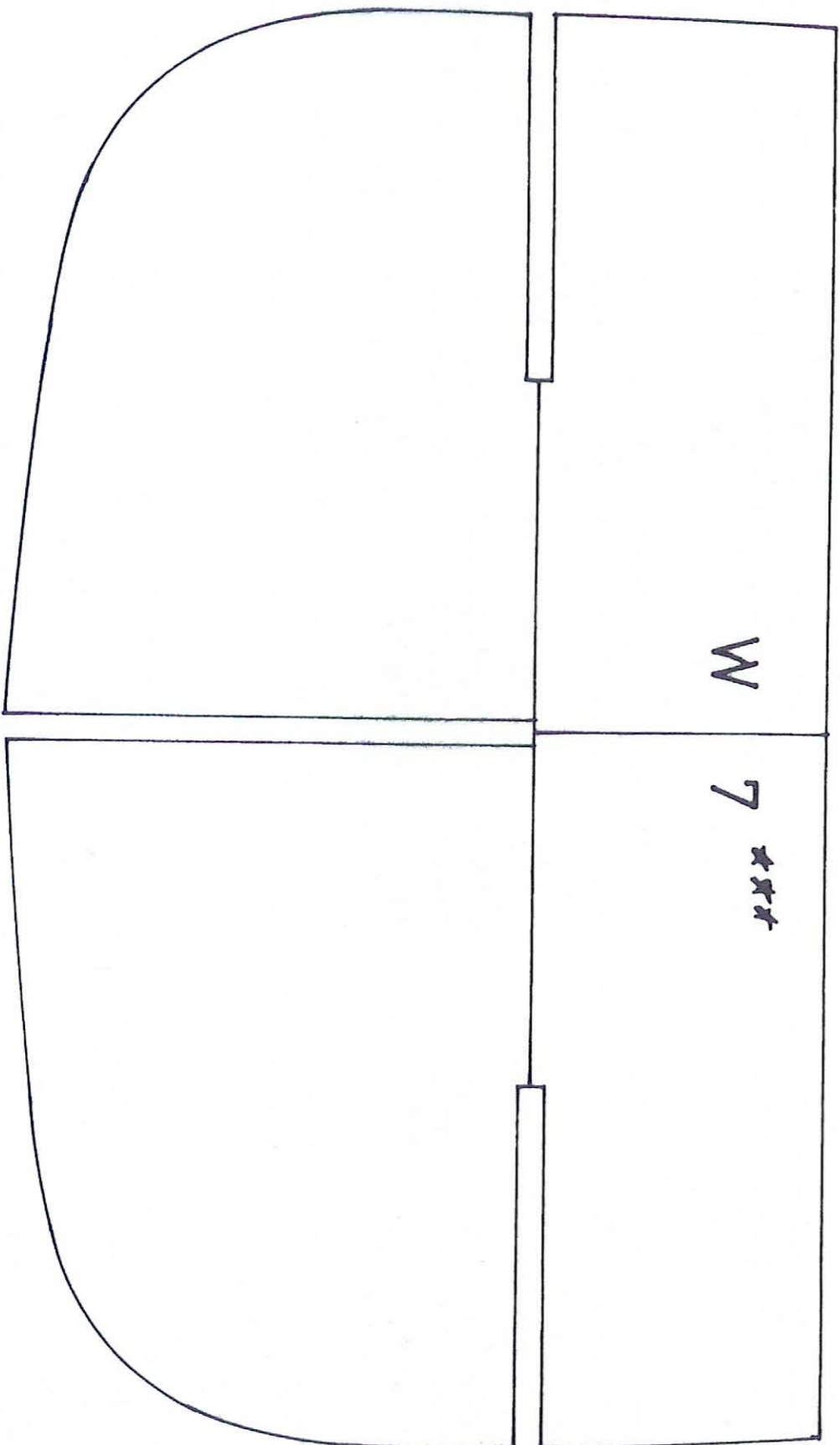
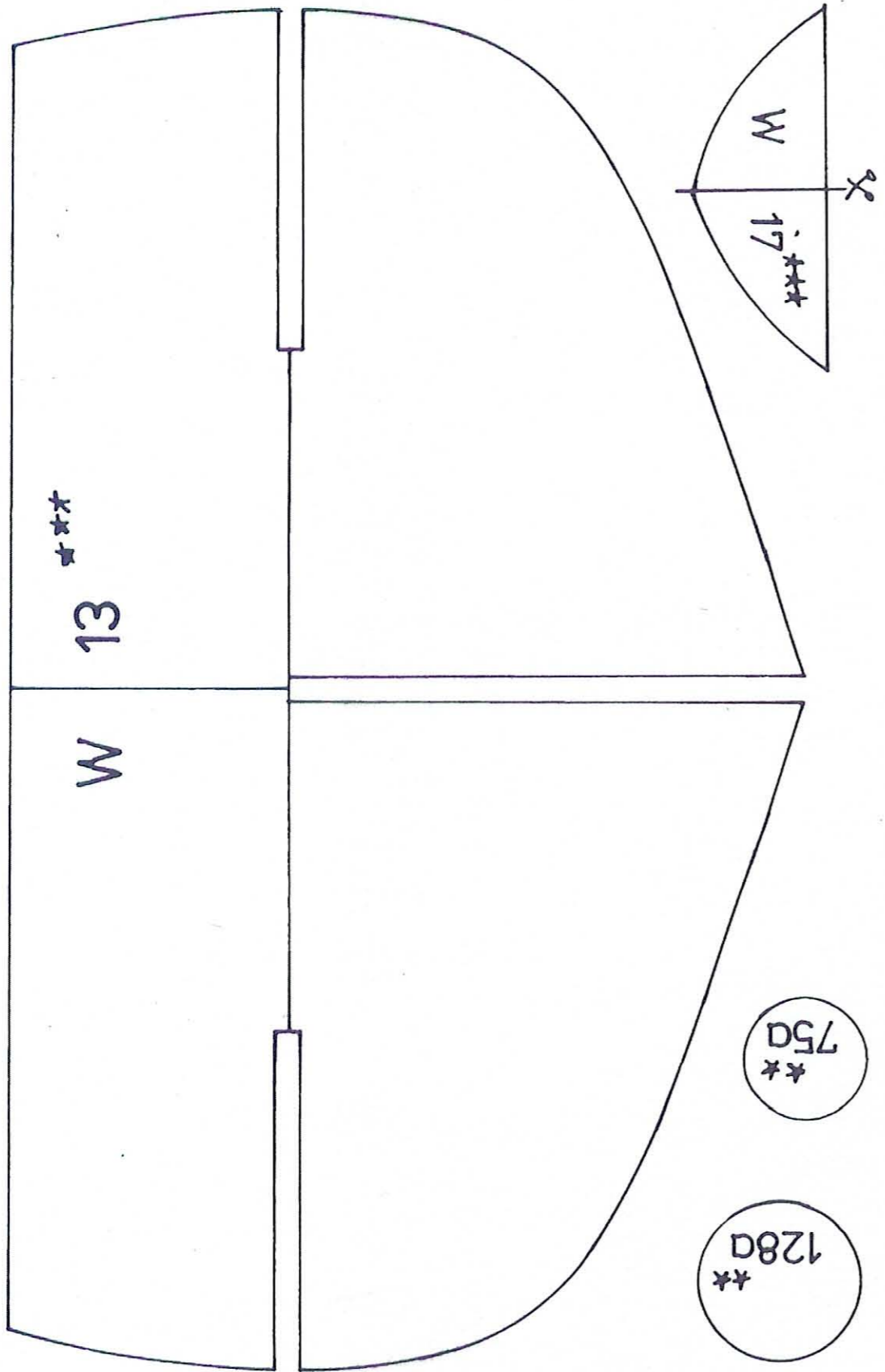
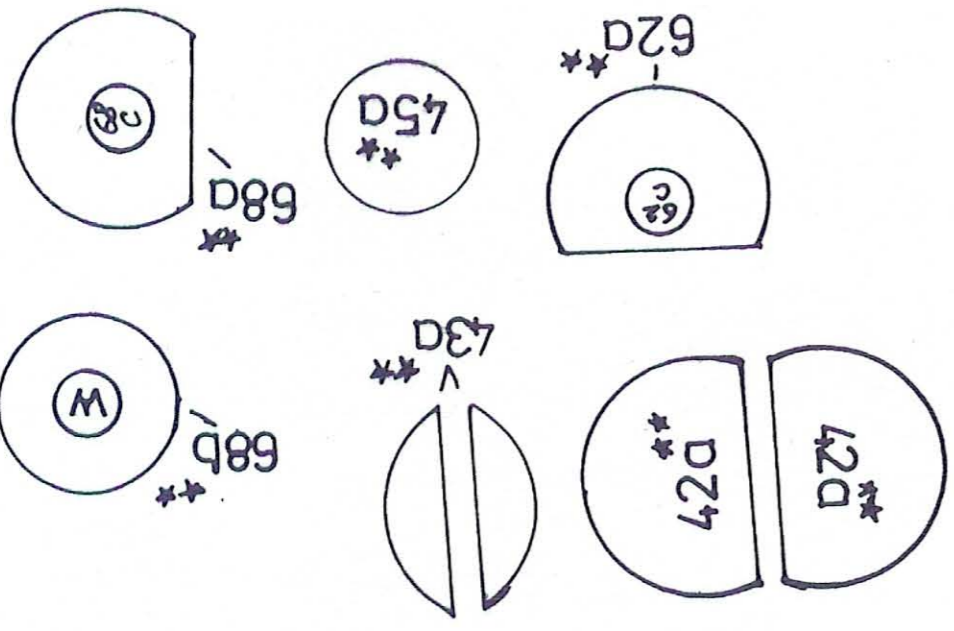

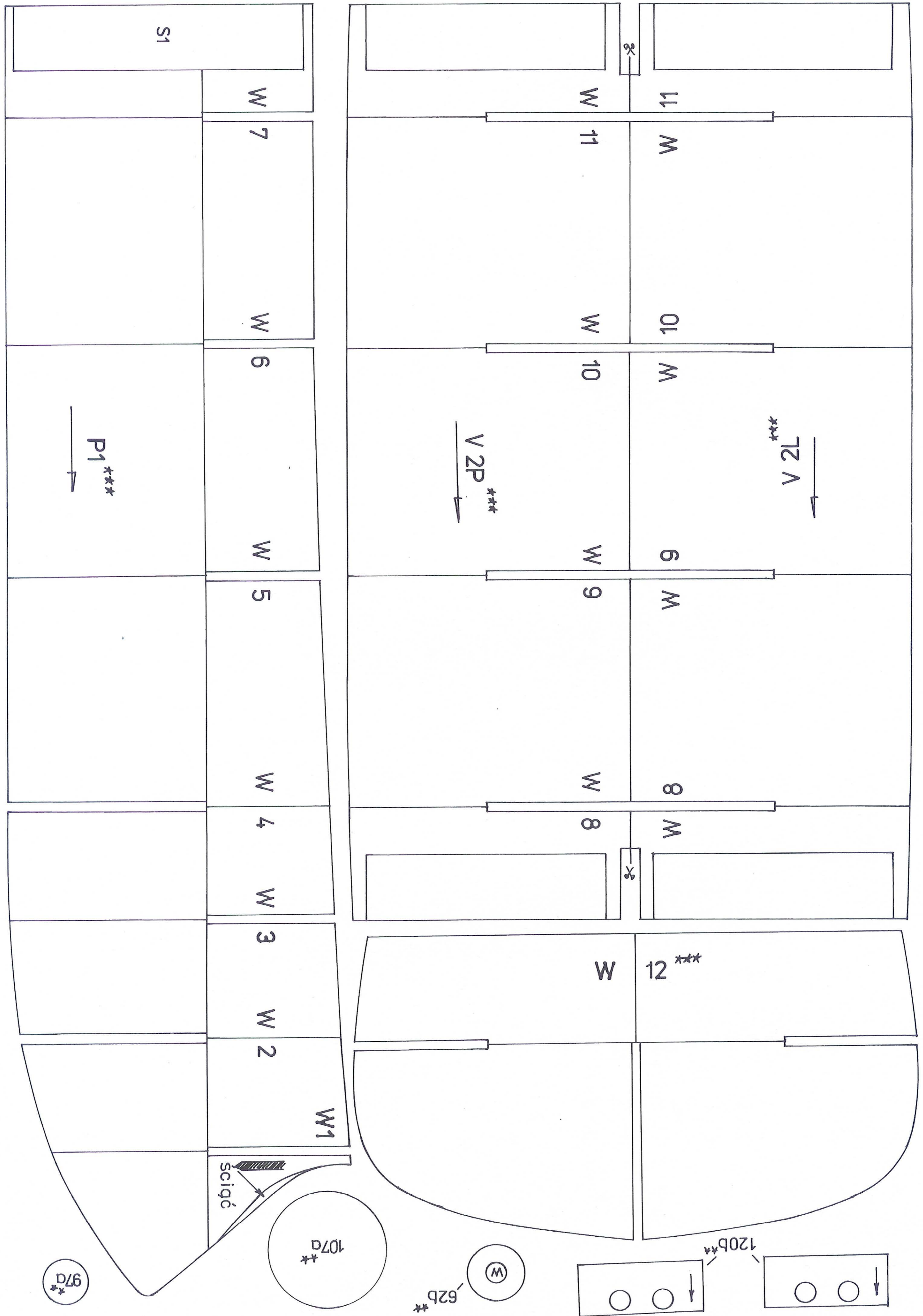

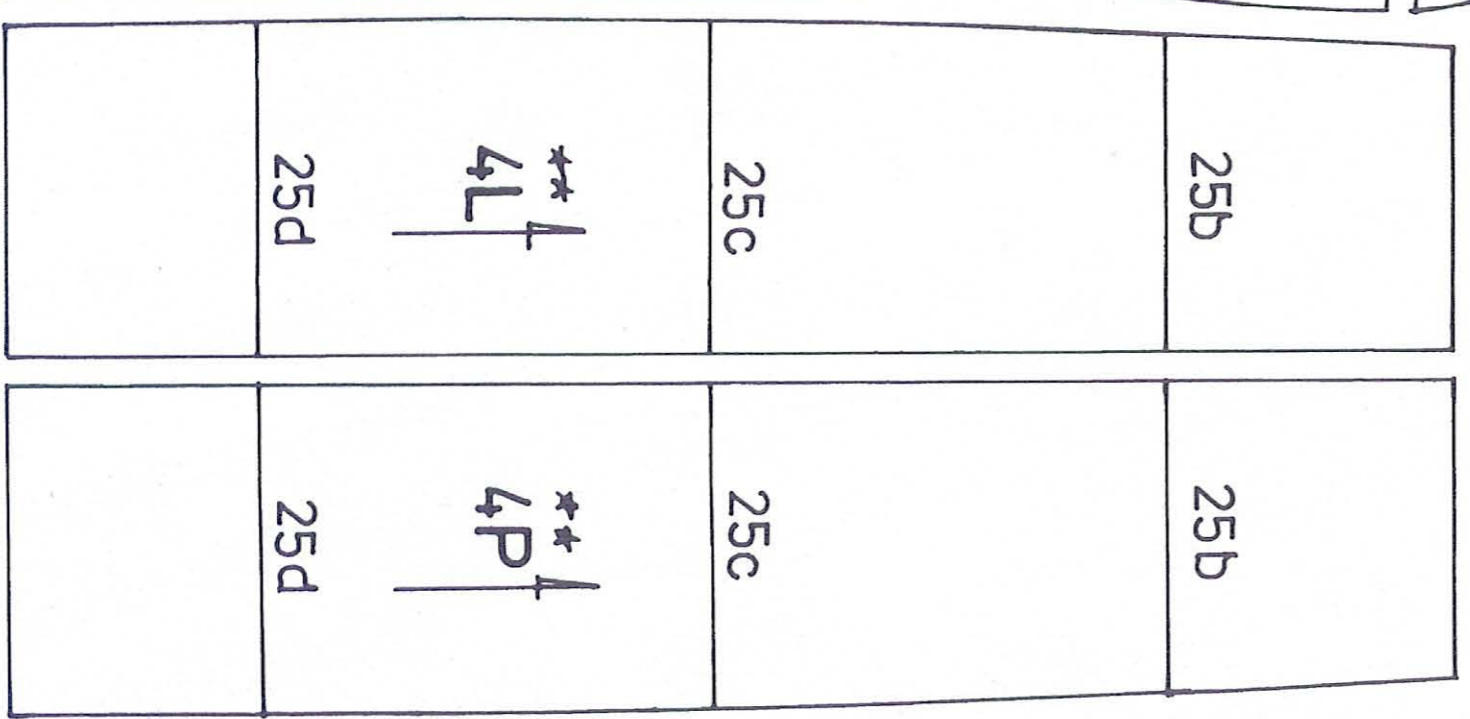
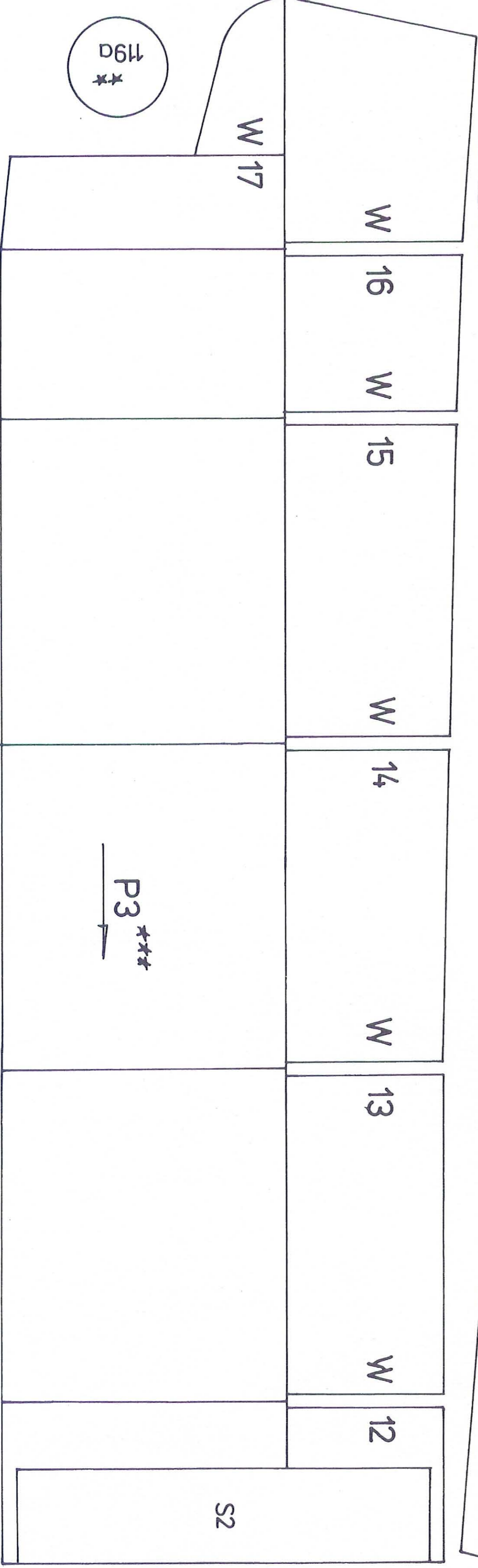
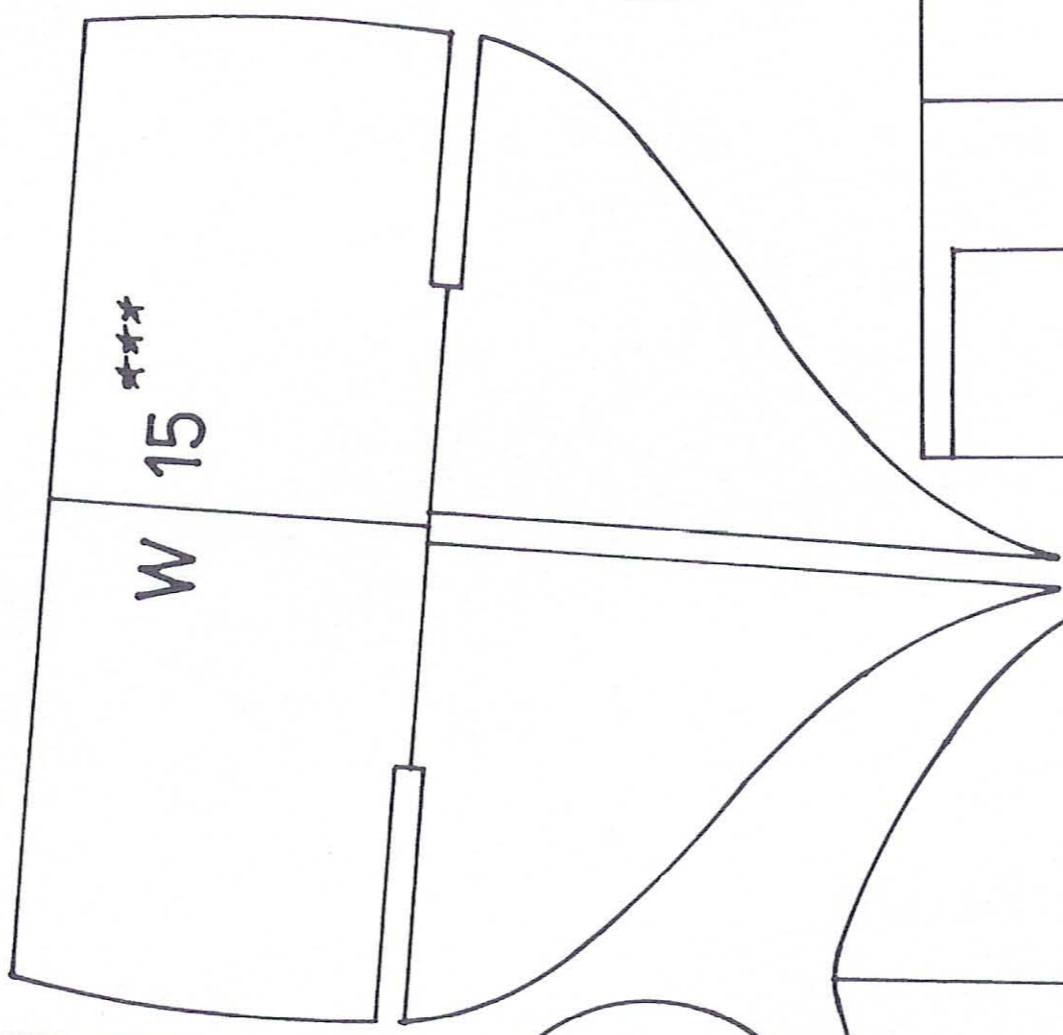
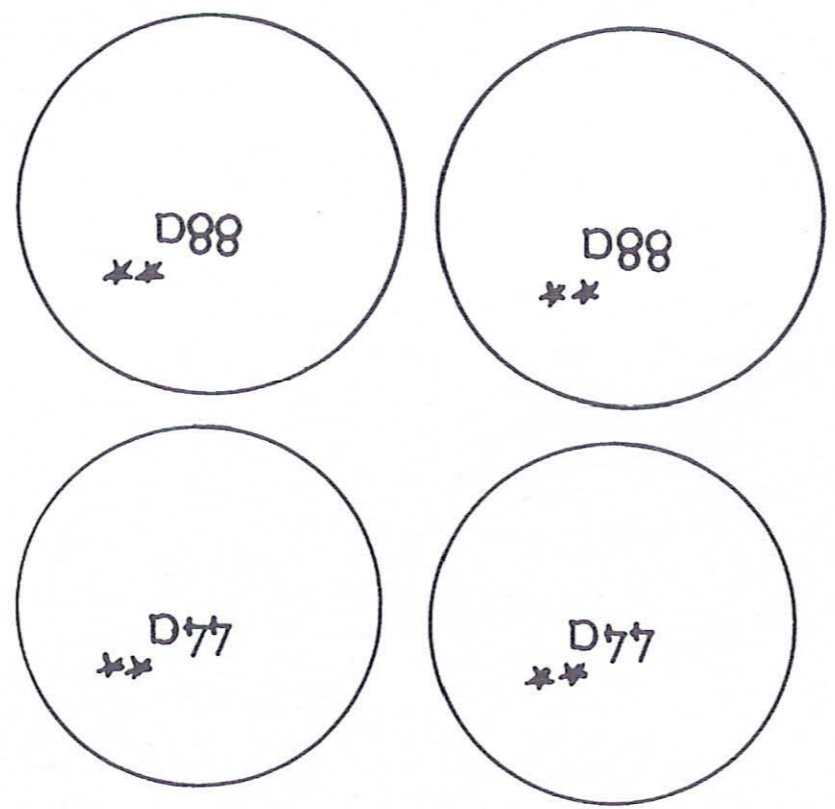
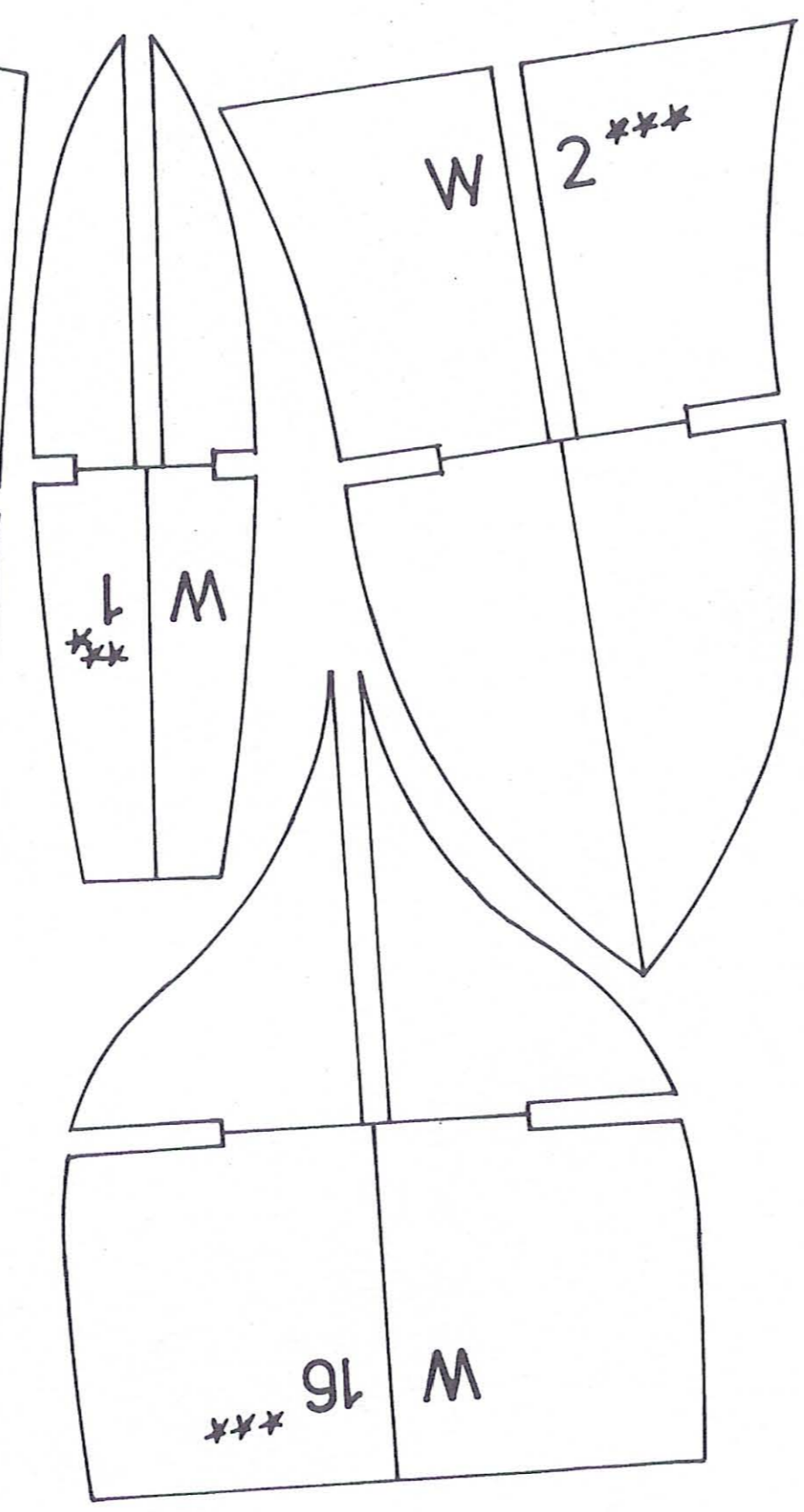
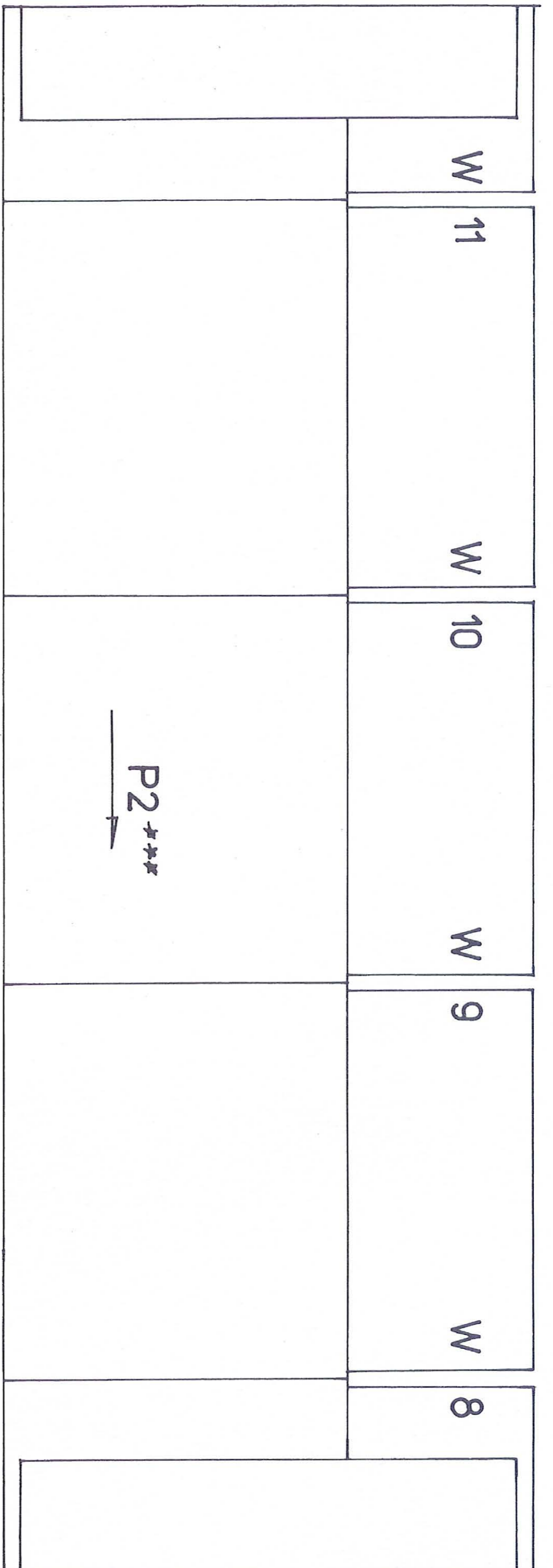

119a
**

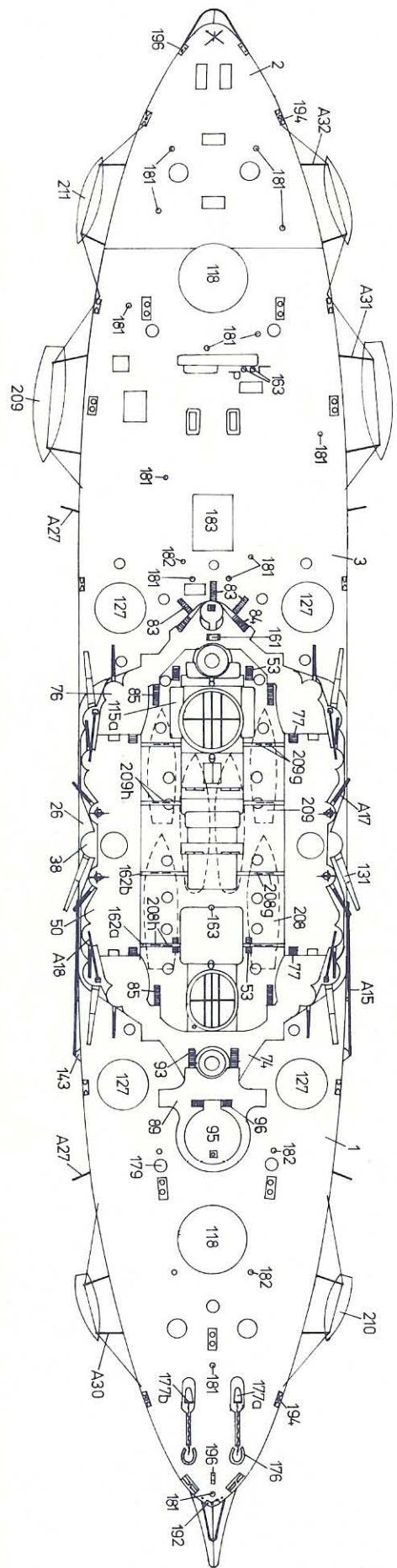
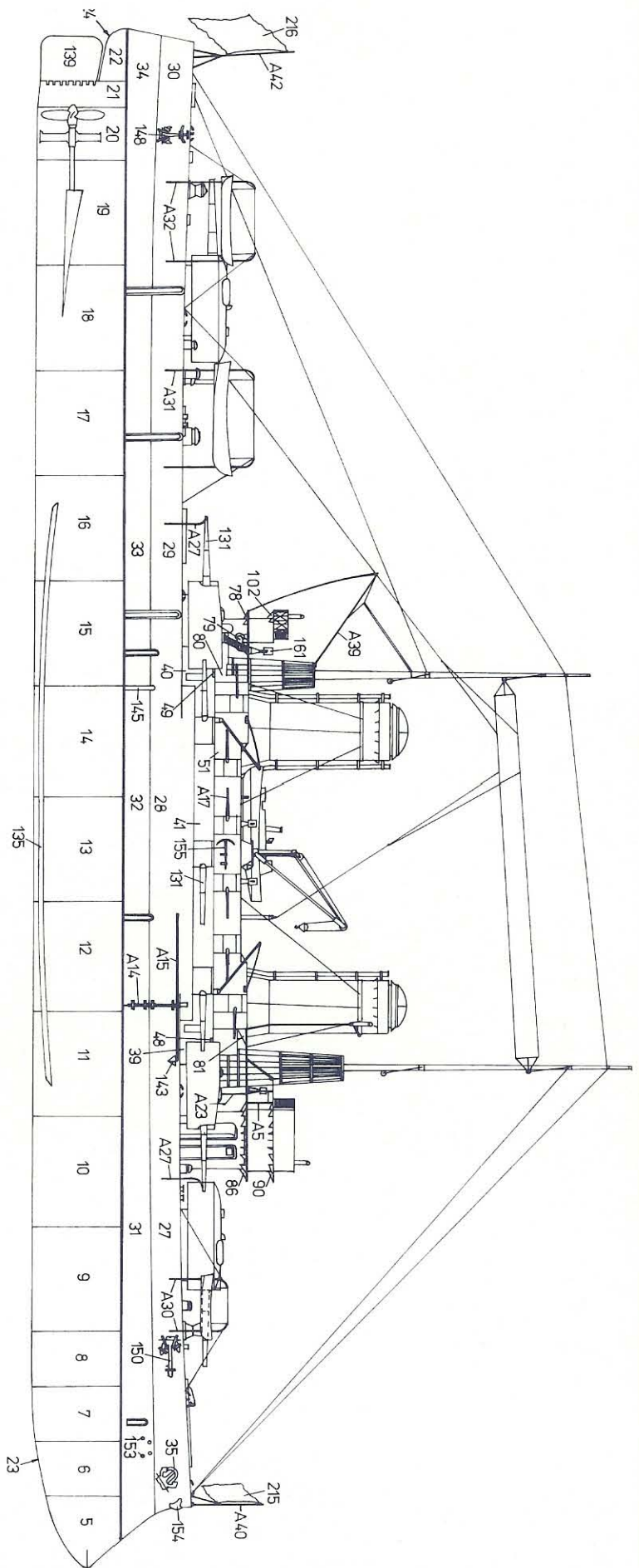

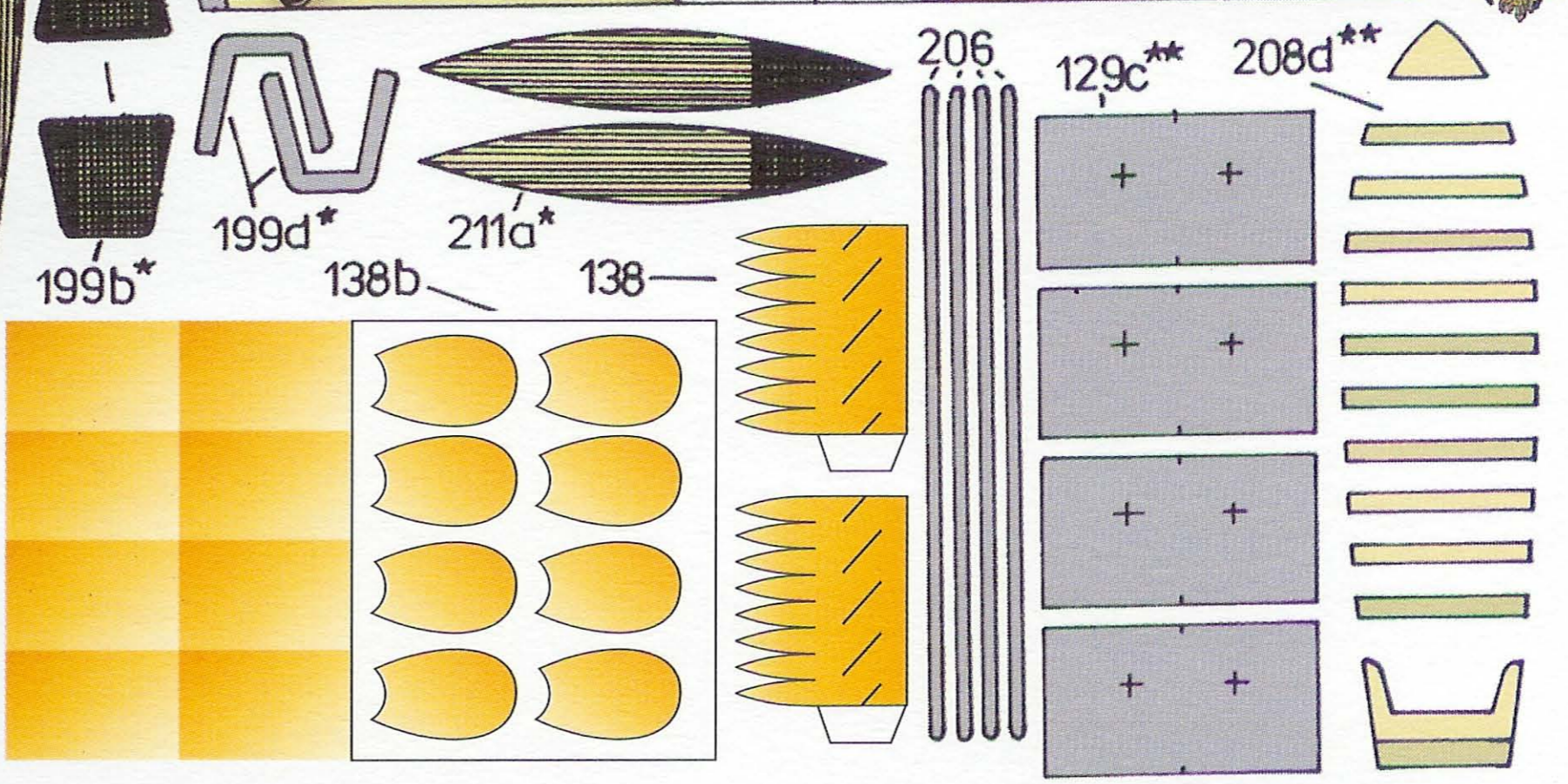
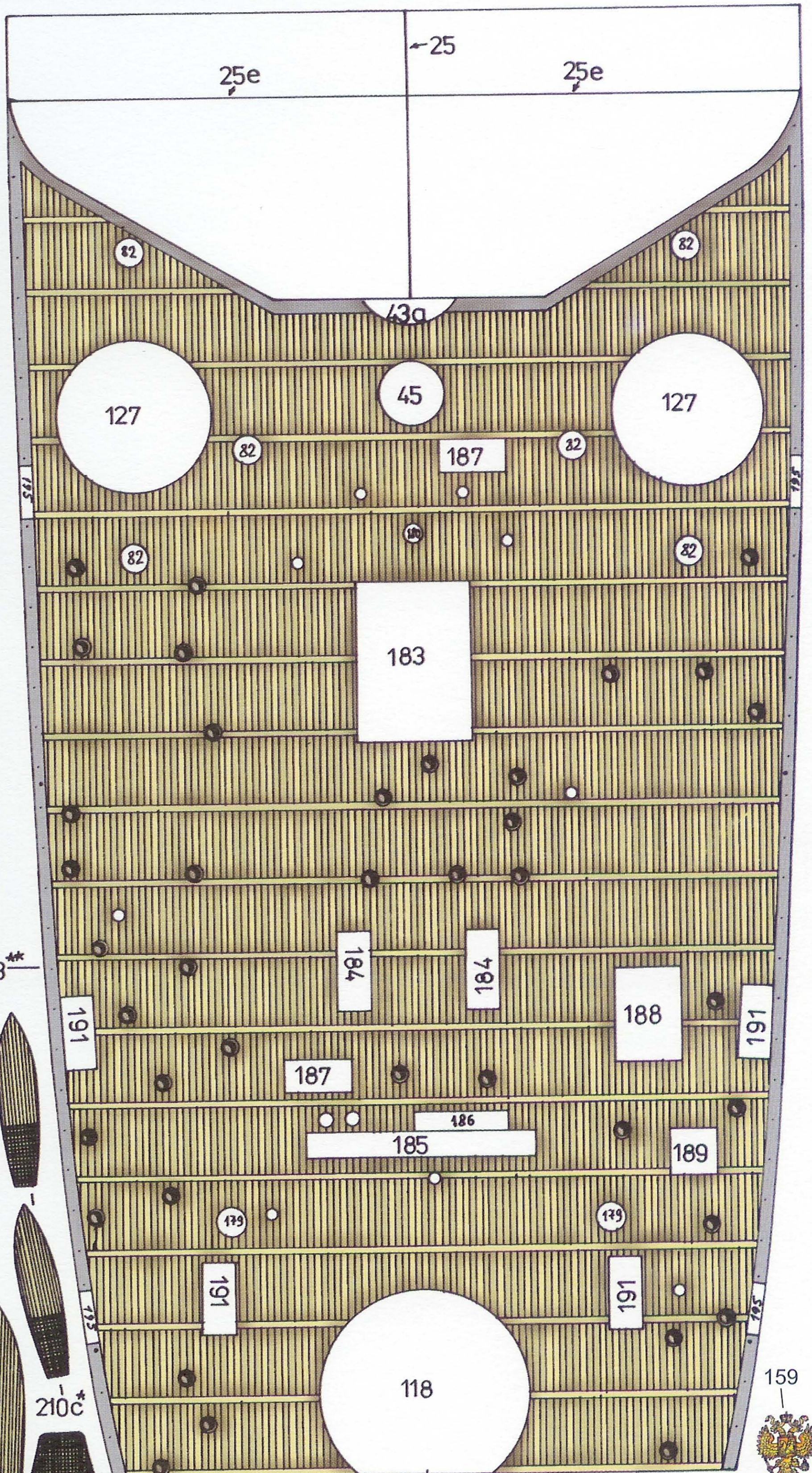
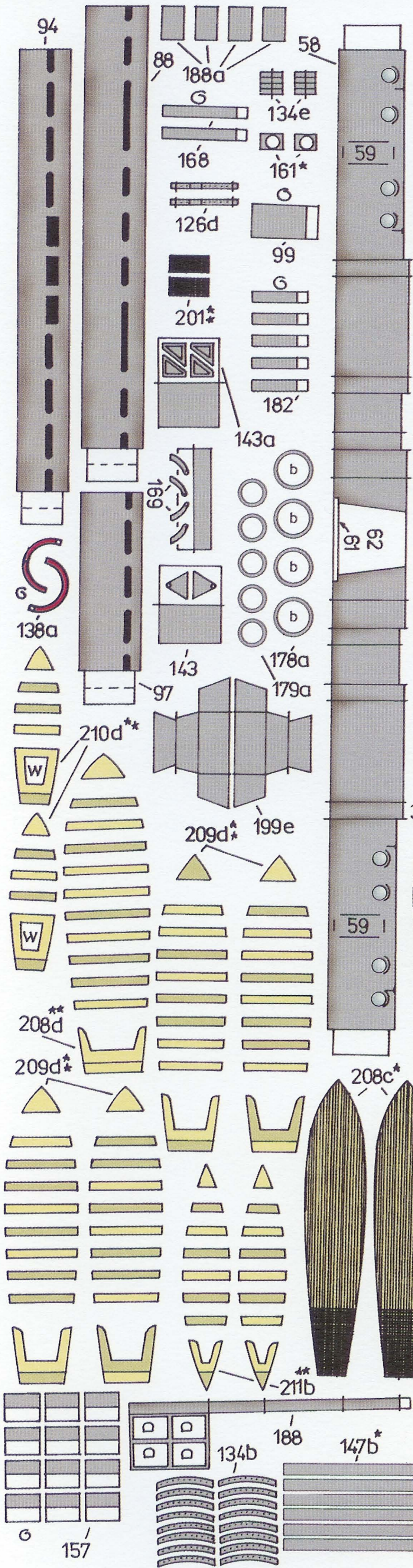

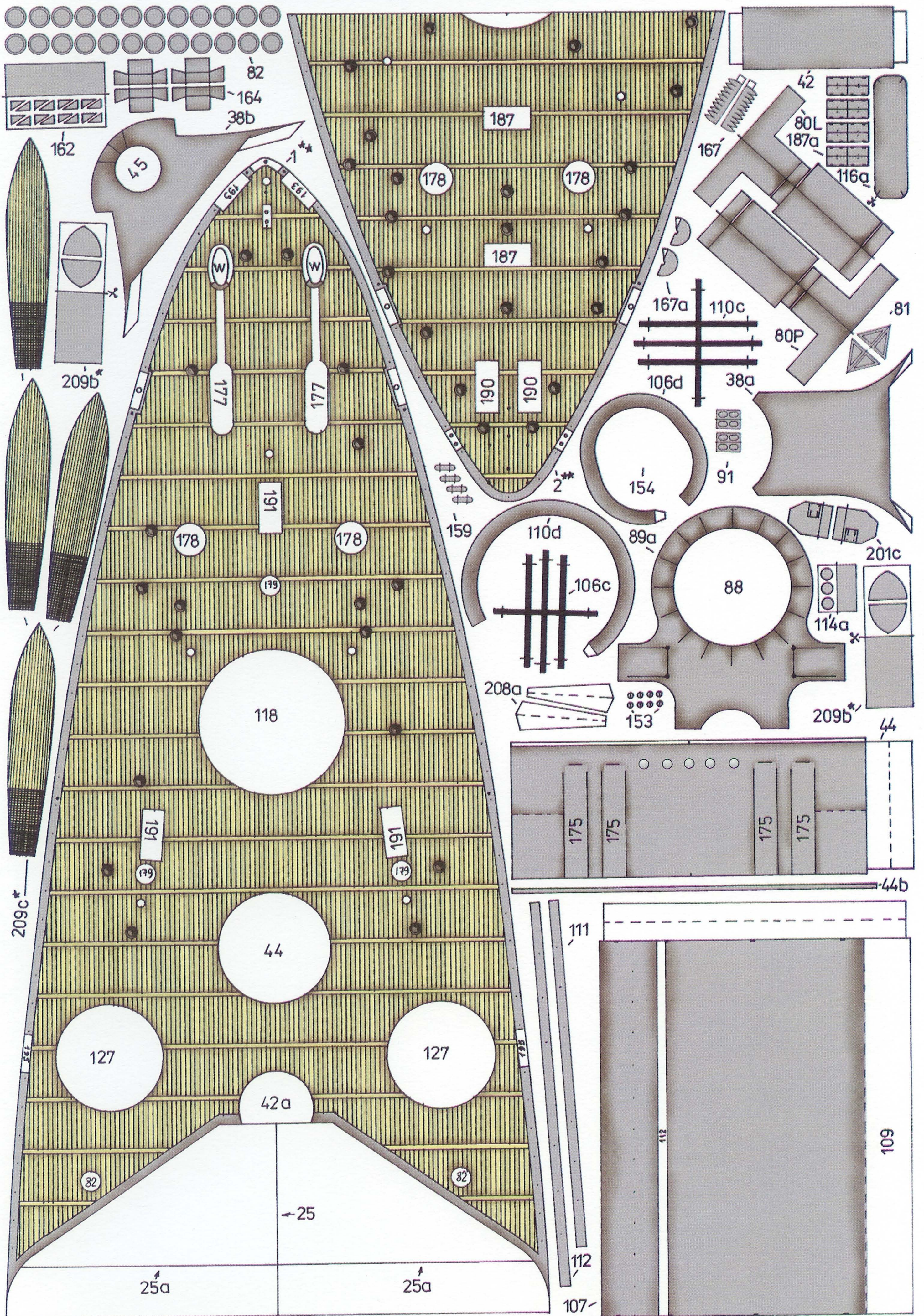

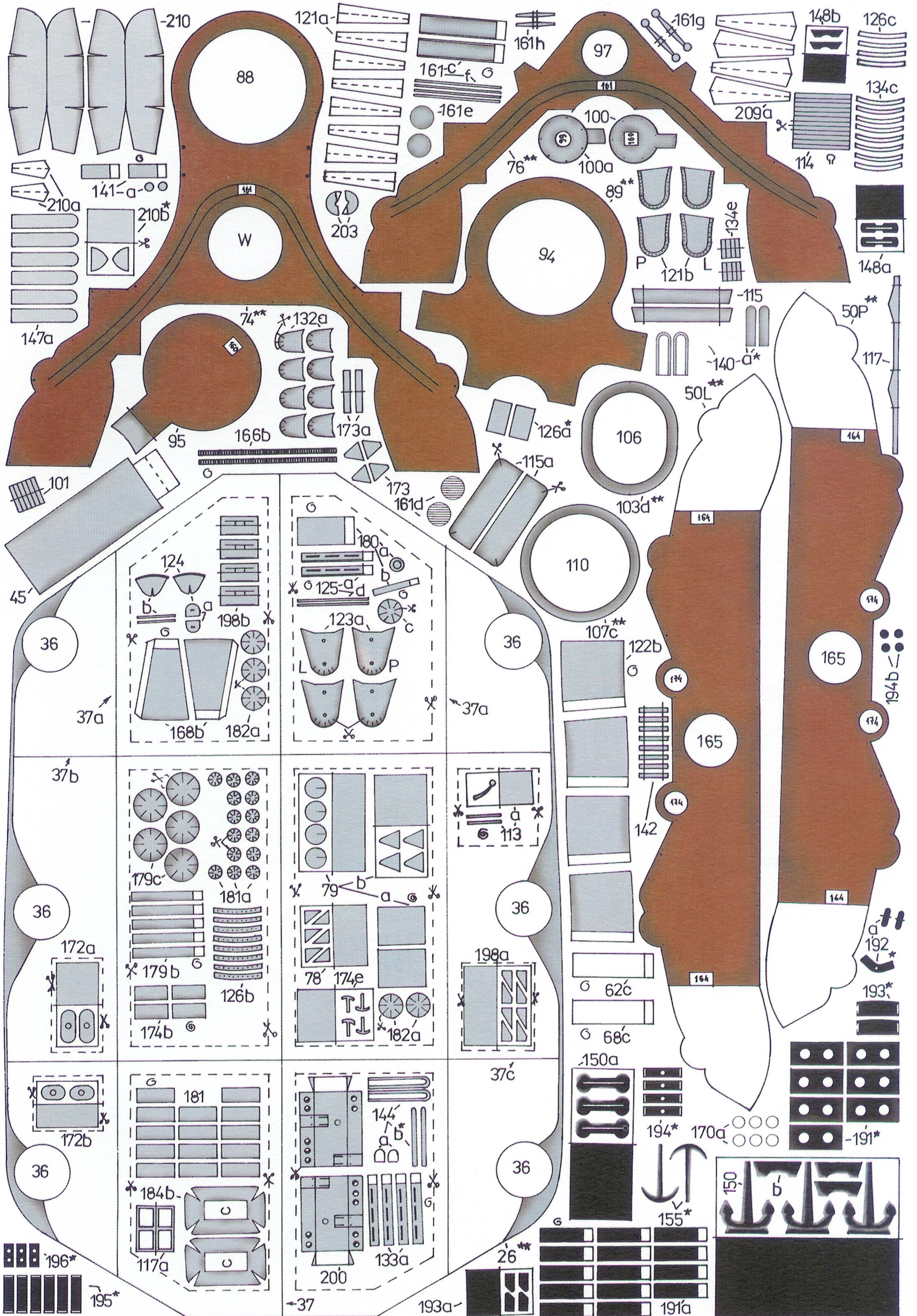

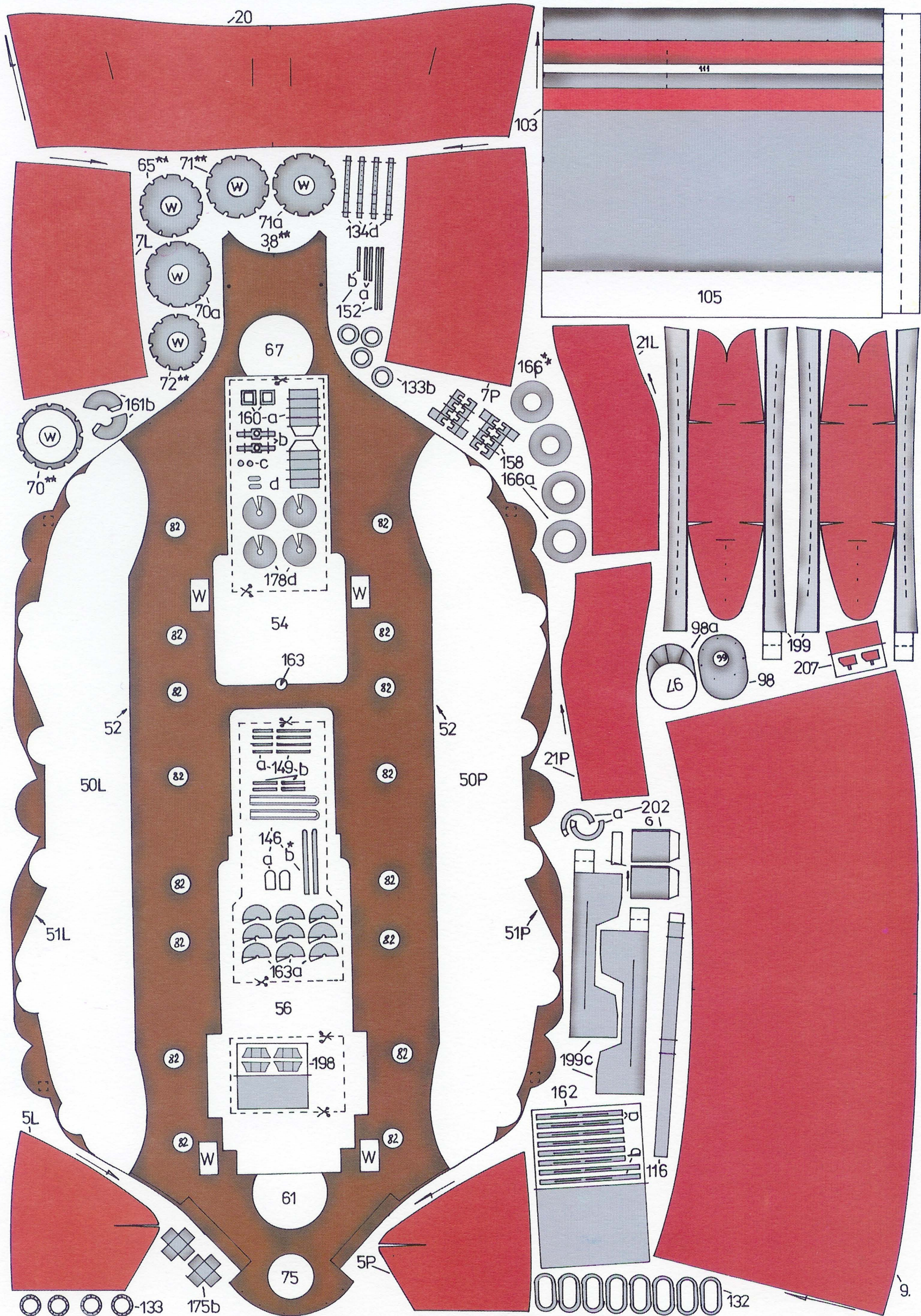

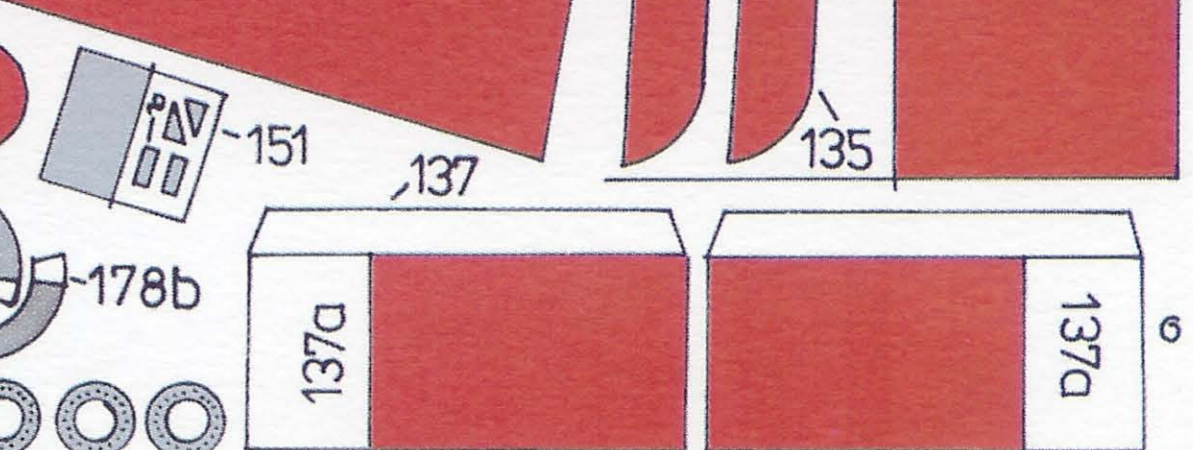
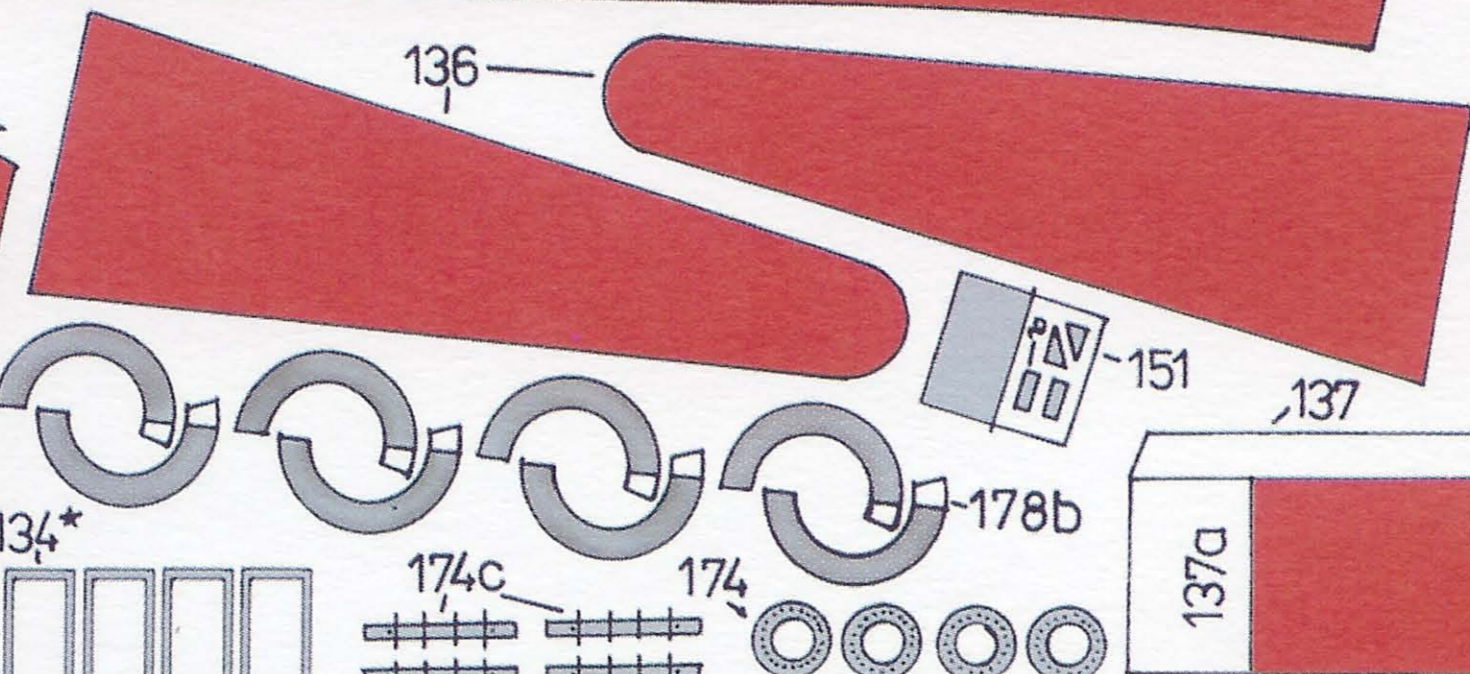
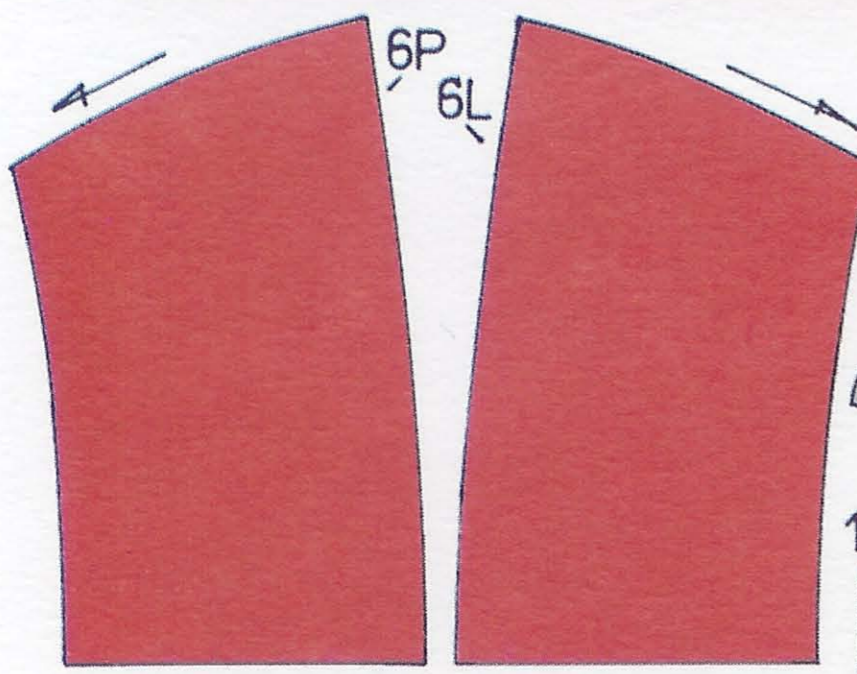
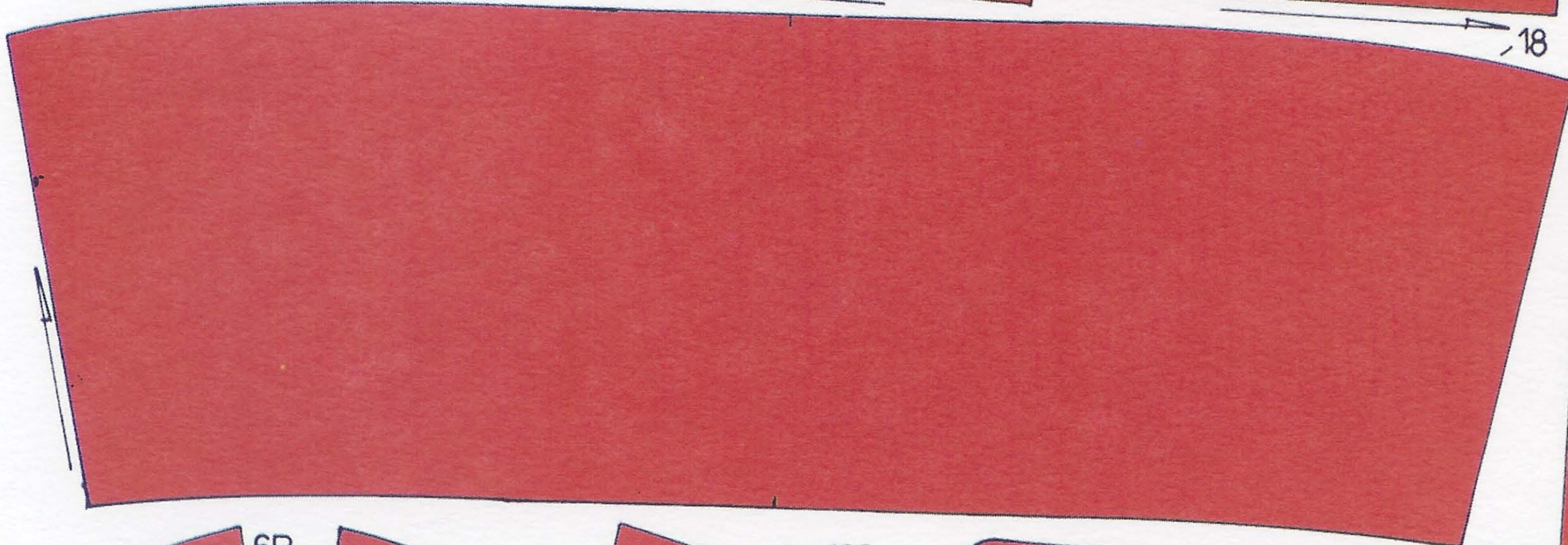

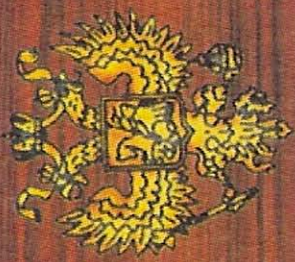

○ АНДРЕЙ ПЕРВОЗВАННЫЙ ○



