

1:300

MODEL KARTONOWY

HMS

HOOD

GPM

NR

23



Opis Budowy
Szkielet kadłuba sklejamy z cz. P1, P2, P3, P4, P5, P6, i rysów W1, W2, W3, W4, W5, W6, W7, W8, W9, W10, W11 oraz pokładu cz. A, B, C, naklejając następnie poszycie dna z cz. D1, D2, D3, D4, D5, D6, D7, D8, D9. Prowadnice cz. D19, D20 i ster D10 montujemy w oznaczonym miejscu wg rysunku. Z cz. 1I, 1P, 1A, 2L, 2P, 3 montujemy burty i oklejamy na szkielecie (uwaga: od wręgi D3 do D6 należy wykonać nacięcie tępym nożem na górnej linii wodnej i odgiąć na zewnątrz 1,5 mm).

Na pokładzie montujemy nadbudówkę cz. 4L, 4P, 5L, 5P, 6L, 7P, 9L, 9P, 9aL, 9aP, 10. Następnie naklejamy pokład cz. 8, 8a. Na dziobie i rufie naklejamy podstawy pod wieże 72a, 72b, 72c. Wieże dowodzenia rozpoczynamy od sklejania podstawy cz. 20, 20a, 20P, 20L, następnie sklejamy w kolejności cz. 15, 15a, 21, 22, 22a, 23, 24, 25, 25a, 26, 26a, 26b, 26c, 28, 28d, 29, 29a, 30, 30a, 30b, 30c, 30d, 31, 31a, 31b, 31c, 31d, 31e, 31f, 31g, 66, 86a i przytwierdzamy druty I, II, III, IV, V wg rys. Za stanowiskiem dowodzenia przyklejamy podstawy pod kominy cz. 32, 33, 34, 34a i kominy cz. 32a, 32b, 32c, 32d, 32e, 32f, 32g. Na pokład naklejamy pozostałe części w oznaczonych miejscach. Maszt rufowy cz. 68, 68a, 69, 69a, 69b, 69c, 70a, 70b, 71, 71a, 71b, 71c i druty VI, VII, VIII, IX, X sklejamy wg rys. Wieże artyleryjskie sklejamy z cz. 73, 73a, 73b, 73c, 73d wg rys. i mocujemy na cz. 72a, 72b, 72c. Z cz. 14, 14a, 14b, 14c, 14d sklejamy działa i przyklejamy do pokładu w oznaczonym miejscu. Na dziobie przyklejamy falochrony cz. 58, 58a, 59, 59a i cz. 60, 60a, 60b, 60c, 60d. Szalupy sklejamy z cz. 76a, 76b, 77a, 77b, 78a, 78b, 78c, 79a, 79b, 79c, 79d, 79e, 79f, przyklejamy do podstawek i mocujemy na pokładzie cz. 8 wg rys.

Pozostałe części należy skleić i montować opierając się o rys. montażowe.

Krążownik Liniowy „HOOD” był najsłynniejszym brytyjskim okrętem wojennym jak również do budowy „Bismarcka” największym. Wybudowany już po Bitwie Jutlandzkiej posiadał dużą szybkość (32,07 w) silne uzbrojenie ale niedoskonały pancierz.

W latach międzywojennych Royal Navy uczyniła z „HOODA” symbol swojej potęgi. Okręt odbywał częste wizyty łącznie z rejssem dookoła świata w latach 1923-24. Pełnił przez cały czas rolę okrętu flagowego Dywizjonu Krążowników Liniowych.

Początek II wojny światowej upływa na rejsach patrolowych i próbach przechwycenia okrętów niemieckich na Atlantyku (m.in. „Adm. Grafa Spee”).

Po upadku Francji zostaje wcielony do „Force H” wraz z 2 pancernikami dokonuje masakry floty francuskiej pod Mers-el-Kebir. Zostaje też tam 2-krotnie trafiony.

W dniu 21.05.HOOD z pancernikami „Price of Welles” wyszedł ze Scapa Flow na przechwycenie „Bismarcka” i „Prinz Eugena” 24.05.1941 w czasie bitwy na Drodze Duńskiej k.foto Islandii zostaje trafiony pociskami „Bismarcka” i po eksplozji wewnętrznej tonie wraz z całą załogą (ocalało 3 ludzi).

Dopełniło się w ten sposób koło brytyjskich krążowników liniowych i „HOODA”.

Na pierwszym krążowniku liniowym INVINCIBLE poległ kontradmirał Hood. Jego nawisko nadano ostatniemu okrętowi tego typu „Invincible” „Hood” oraz 2 inne wybudowano w Royal Navy zatopiony z całymi załogami po eksplozjach wewnętrznych

Dane dł. 262,2 m, szer - 31,7 zanurzenie 8,7, wyporność 48360 t, uzbrojenie 8x 381, 12x140 4x102, 18x40

Model przedstawia wygląd okrętu z roku 1935

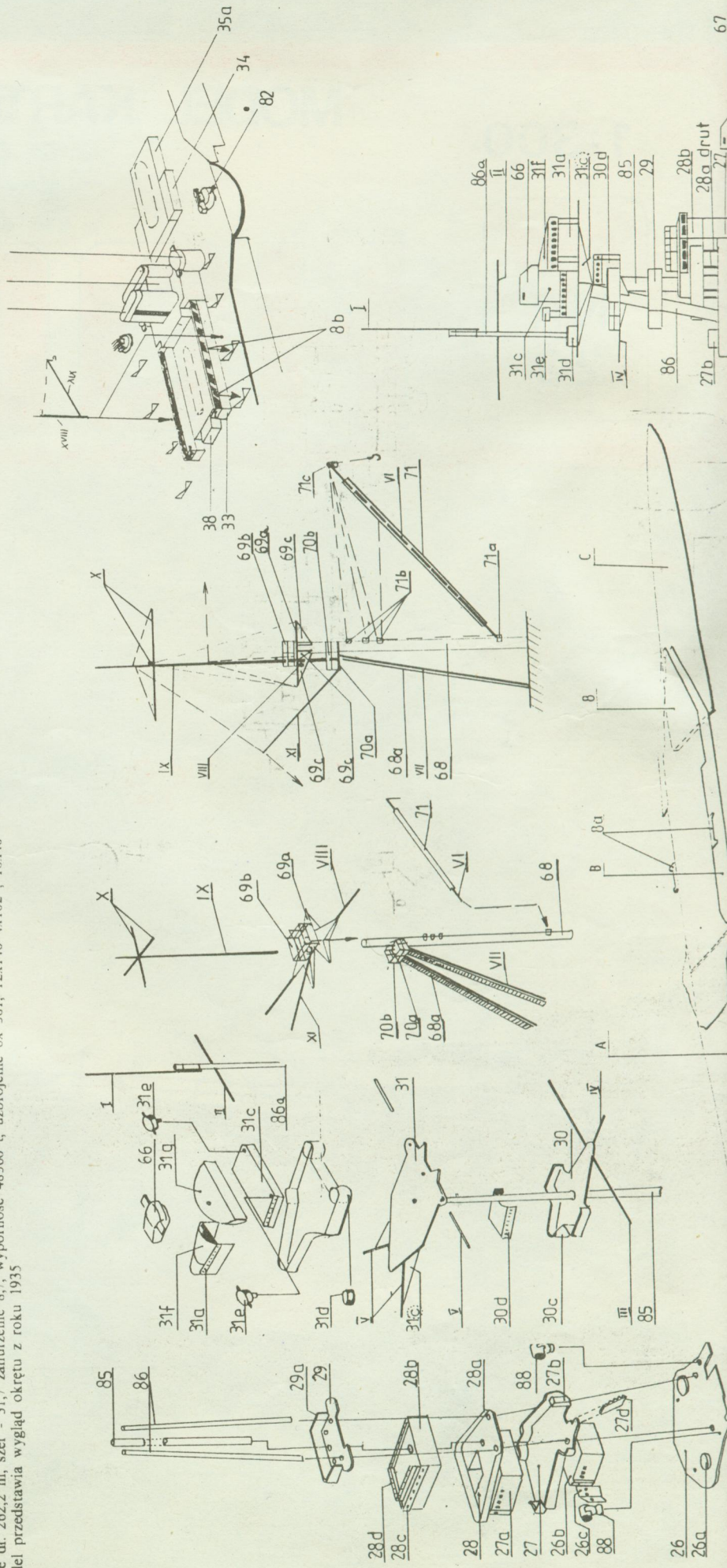

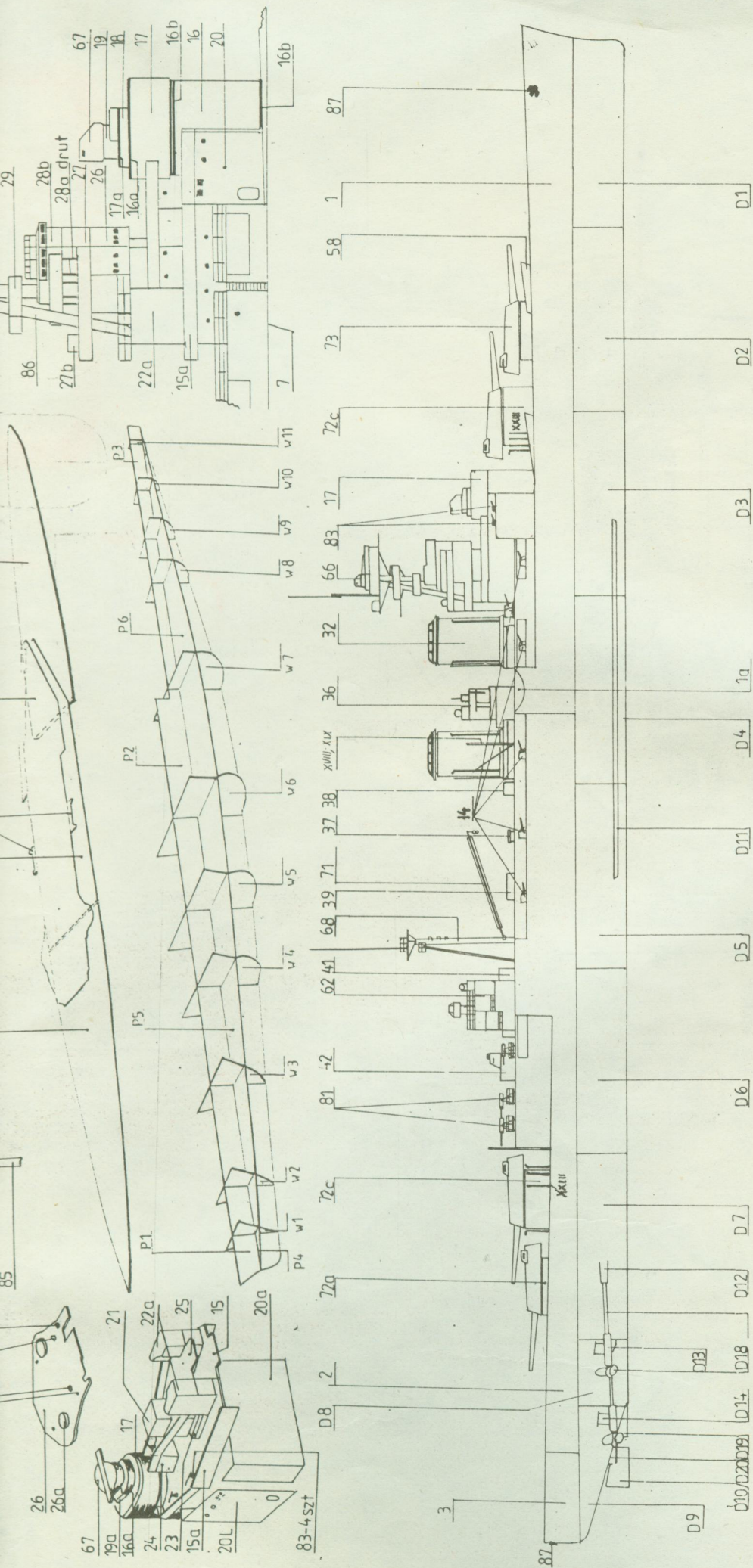

Firma "GPM" oferuje szeroki asortyment modeli kartonowych dostępnych w ramach sprzedaży wysyłkowej. Wykaz z cenami po przesłaniu zaadresowanej koperty na adres : Grzegorz Pomorski 90-954 Łódź skr.poczt.13

Wkrótce ukaze się model lotniskowca US-NAVY USS LEXINGTON W przygotowaniu m.in. Heinkel He-111H6 M1 ABRAMS Schnellboot S-10

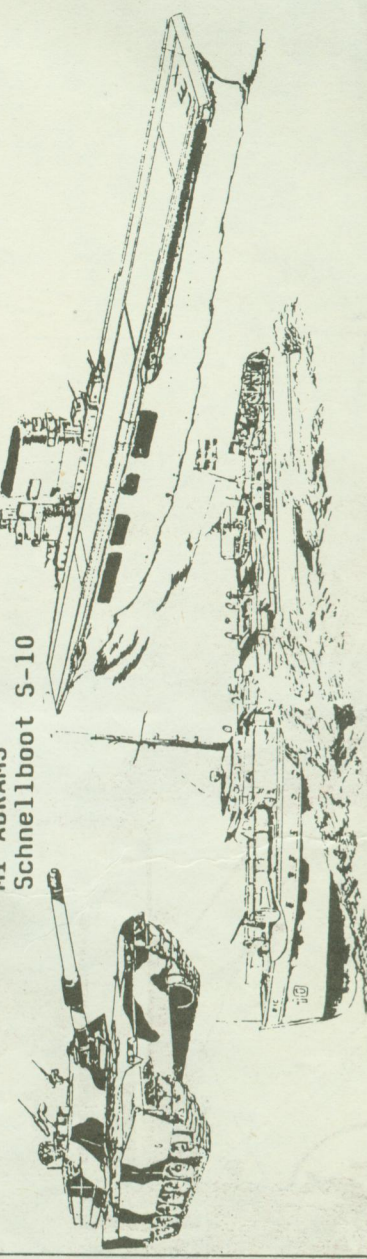

Producent :

GPM 90-954 Łódź skr.poczt.13.

tel.57-62-10 wewn.160

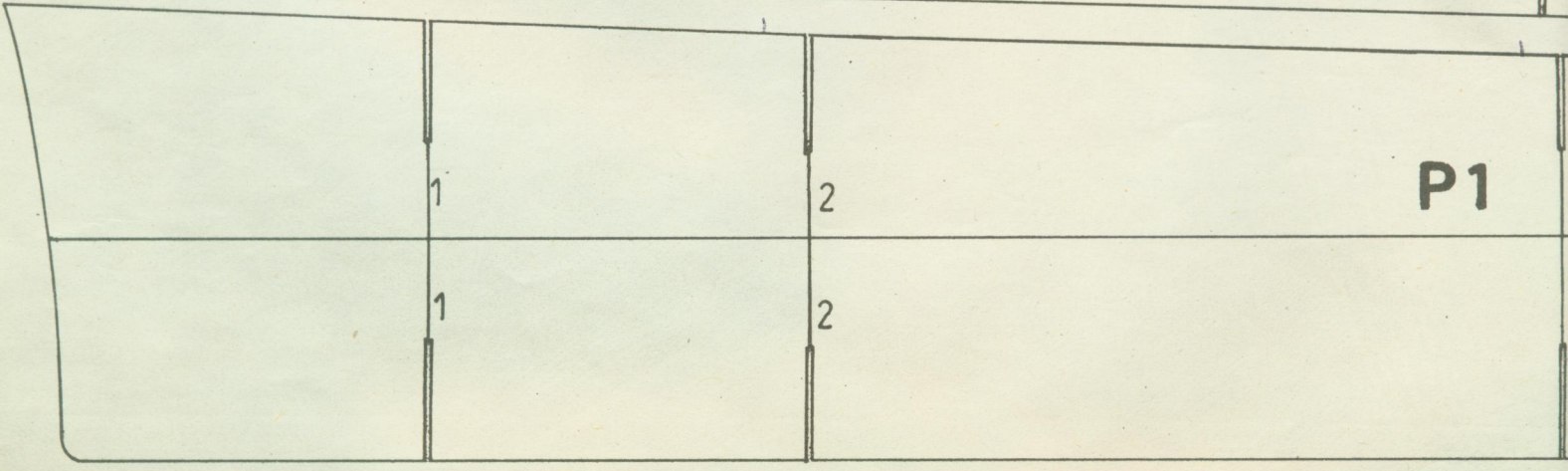
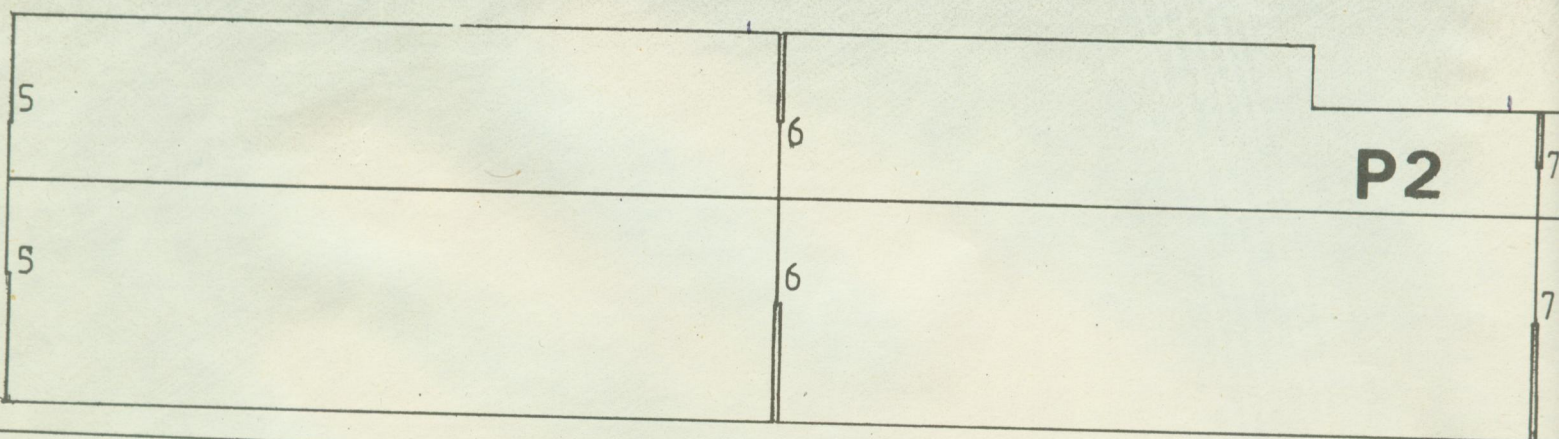
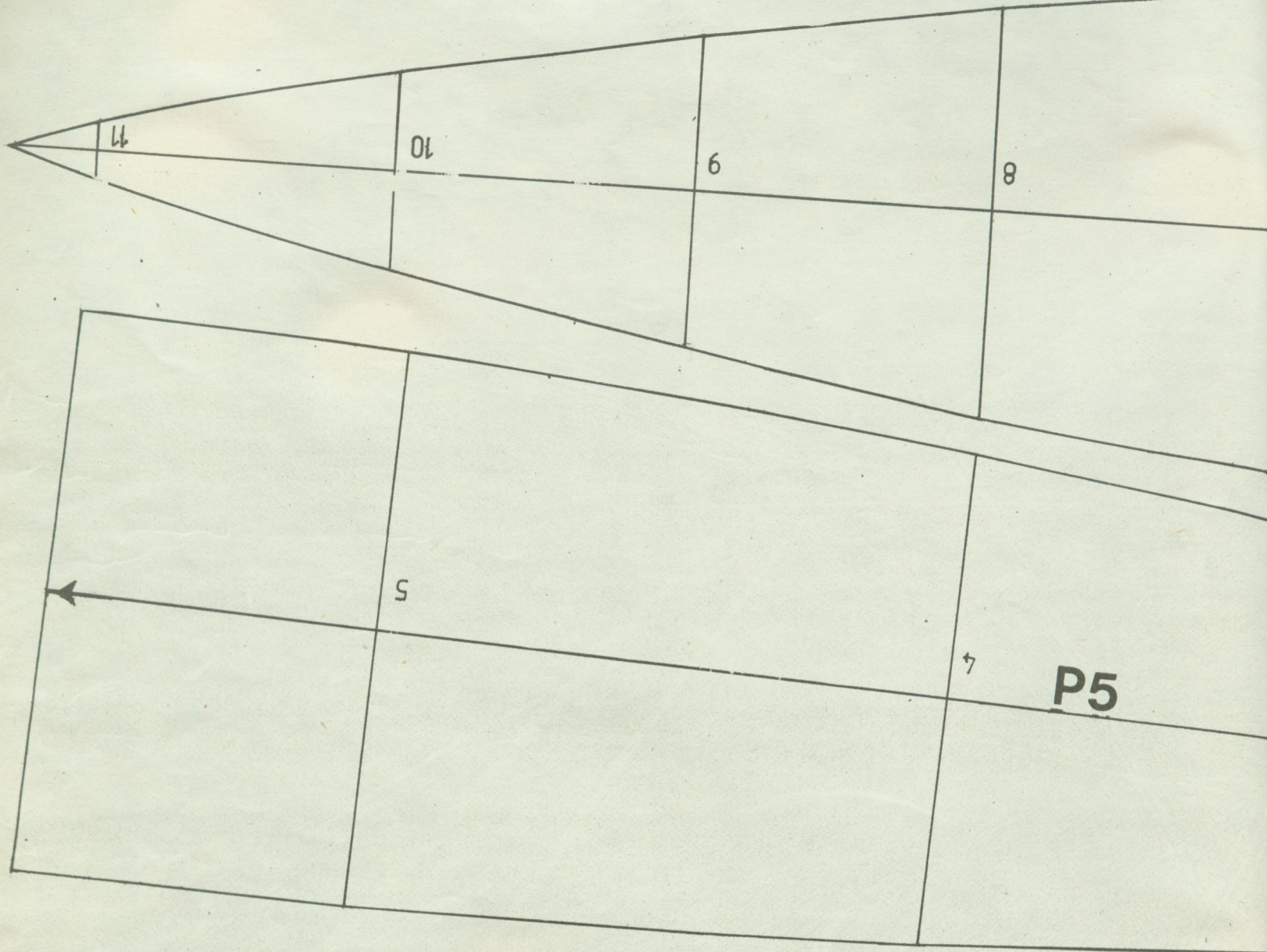

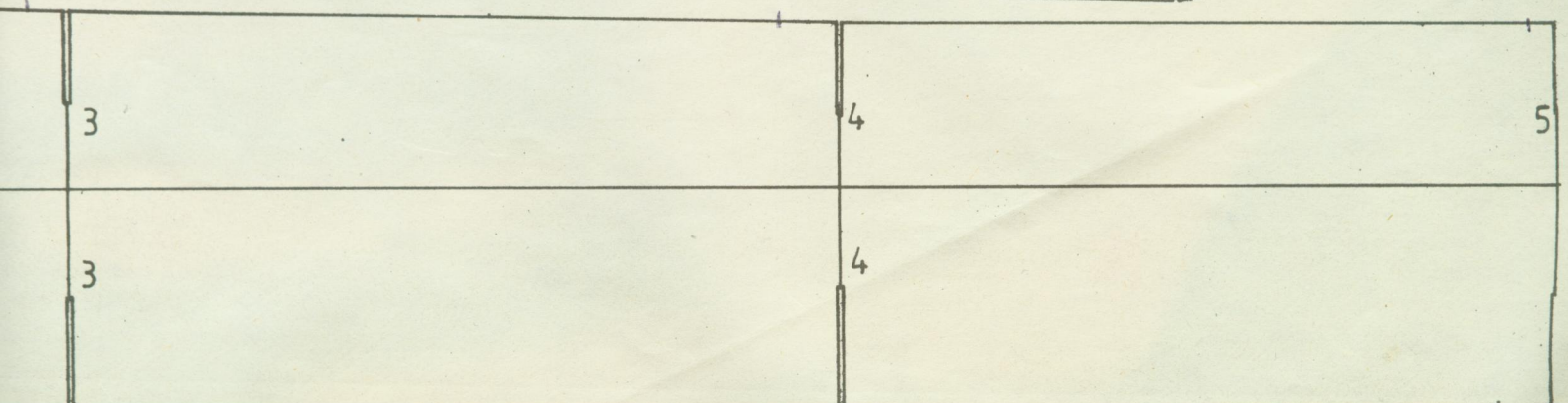
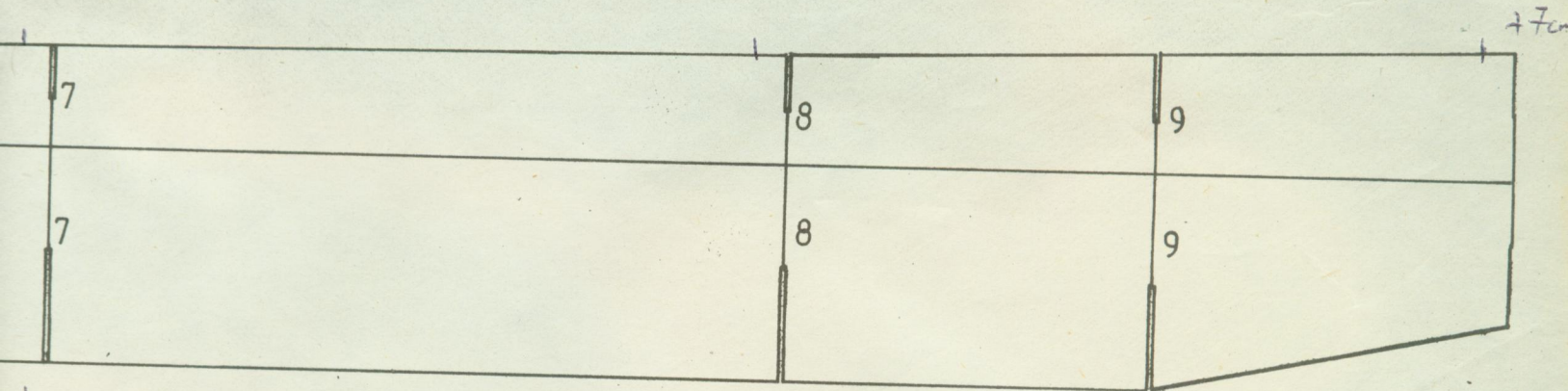
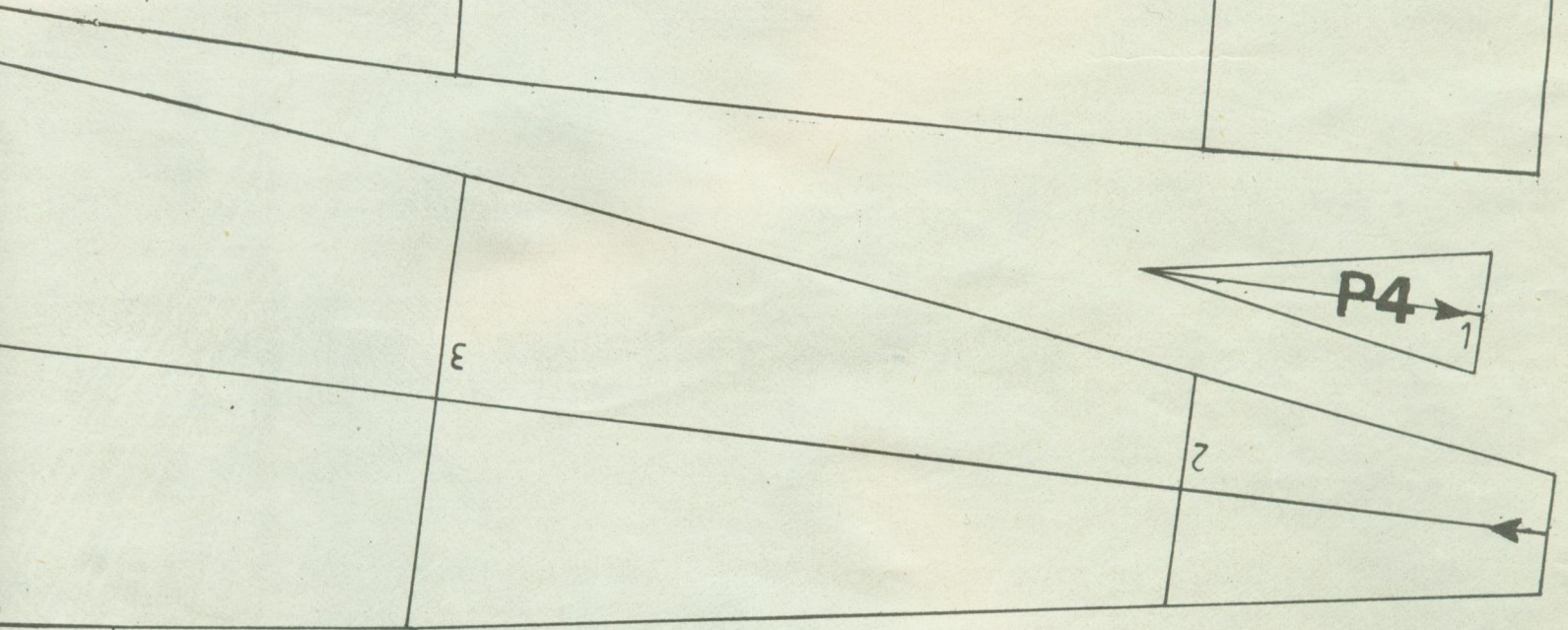
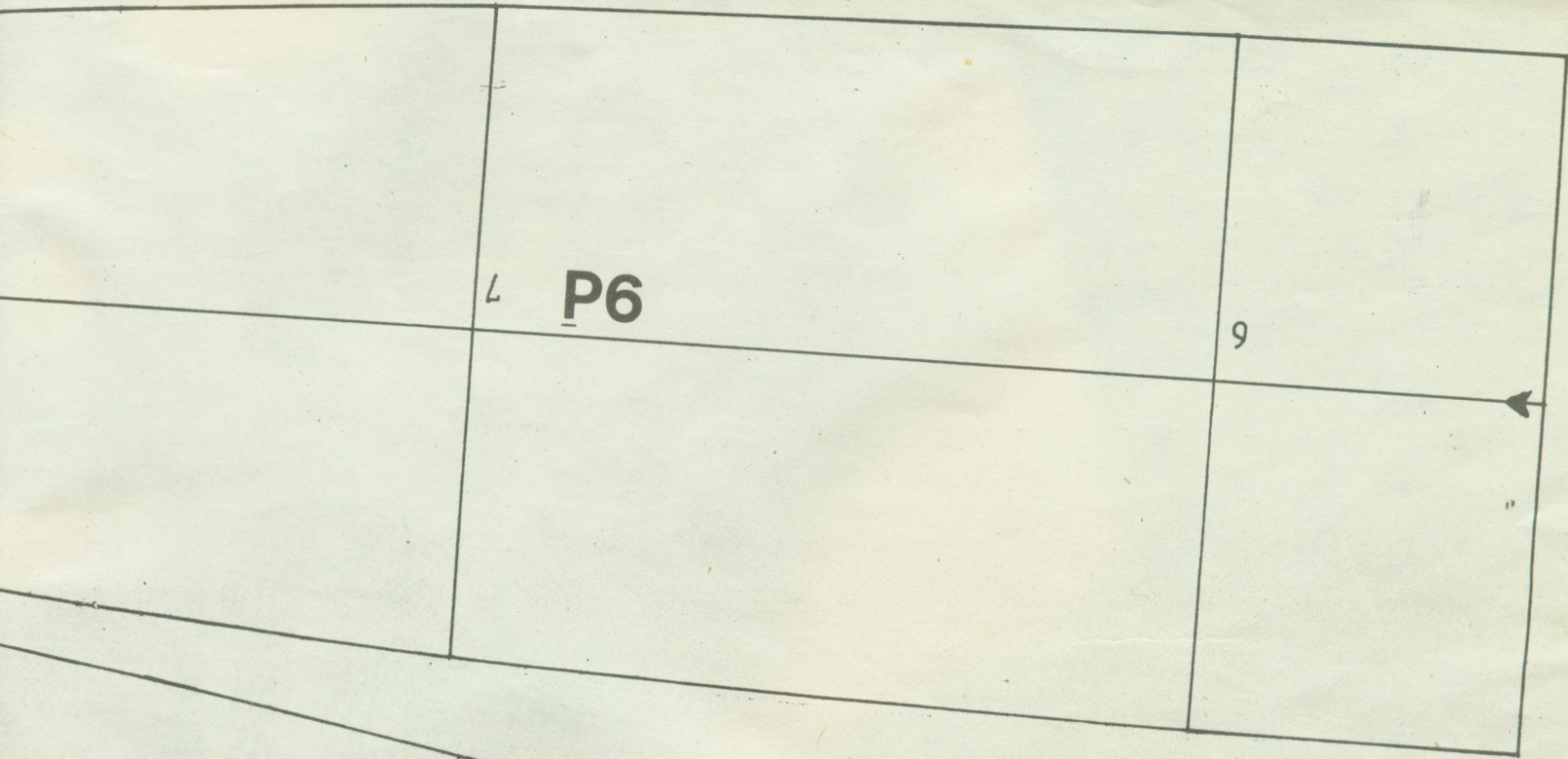

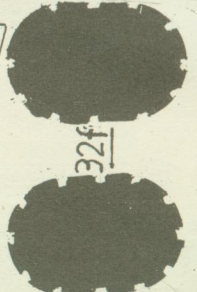
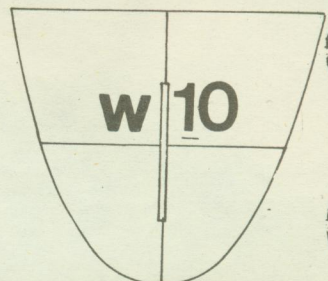
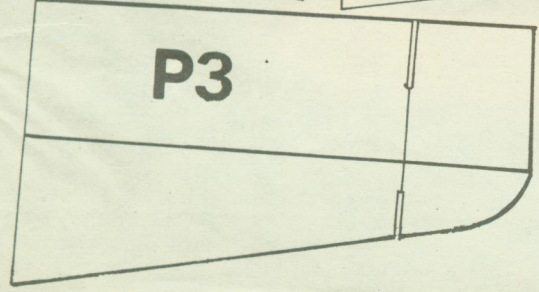
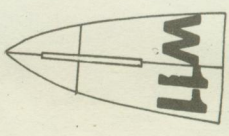
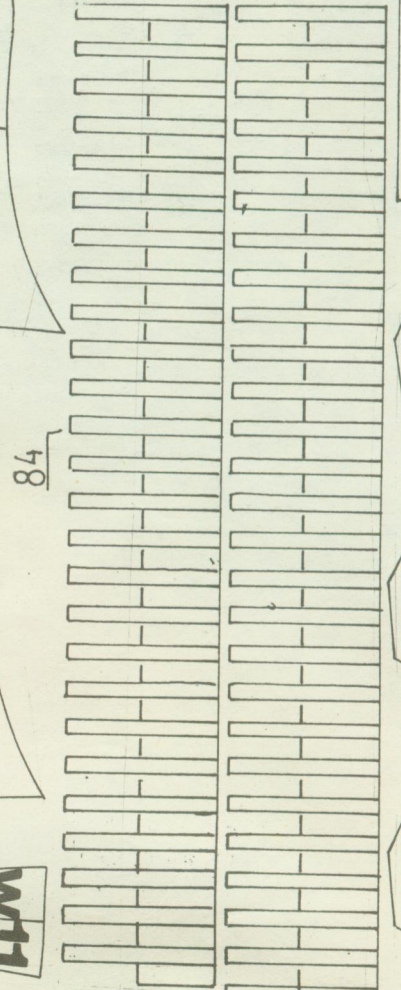
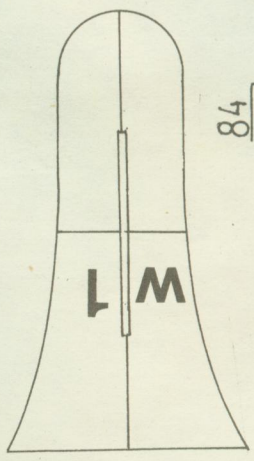
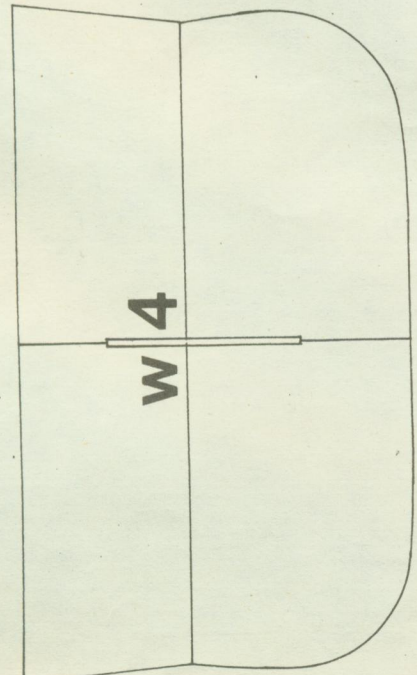
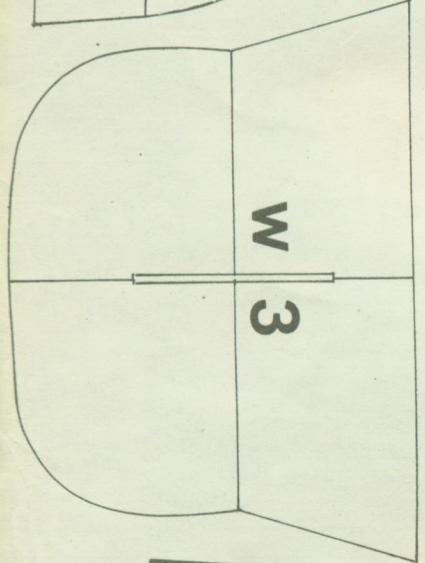
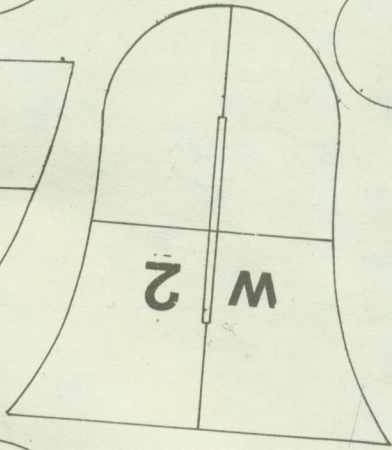
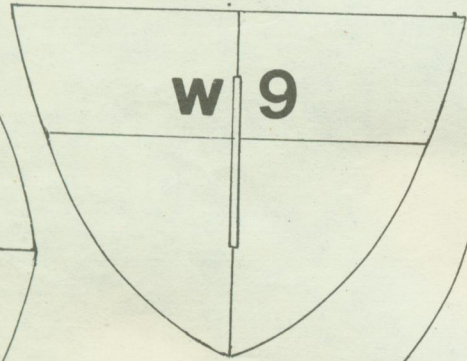
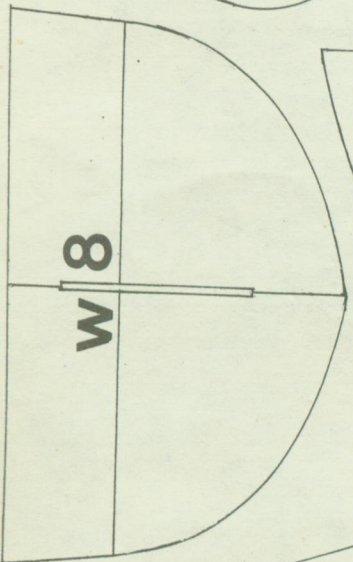
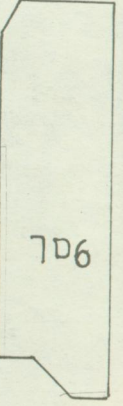
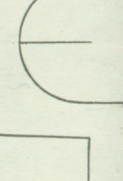
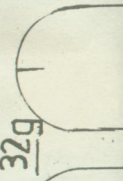
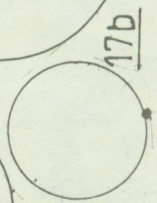
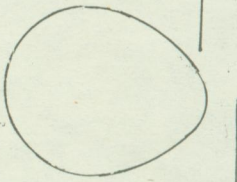
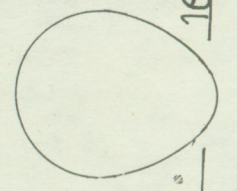
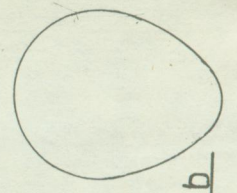
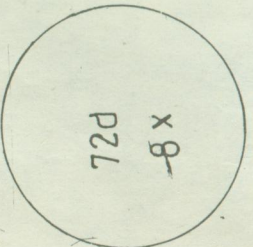
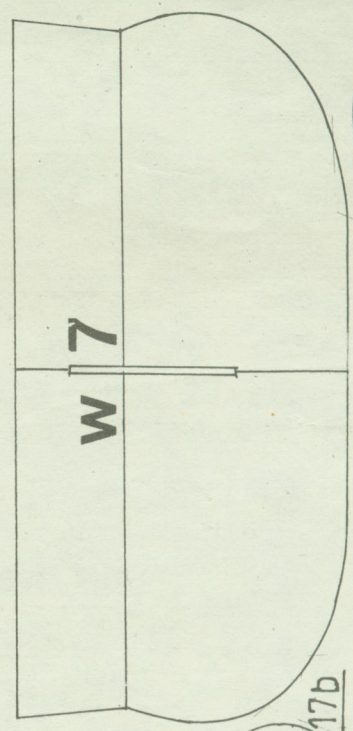
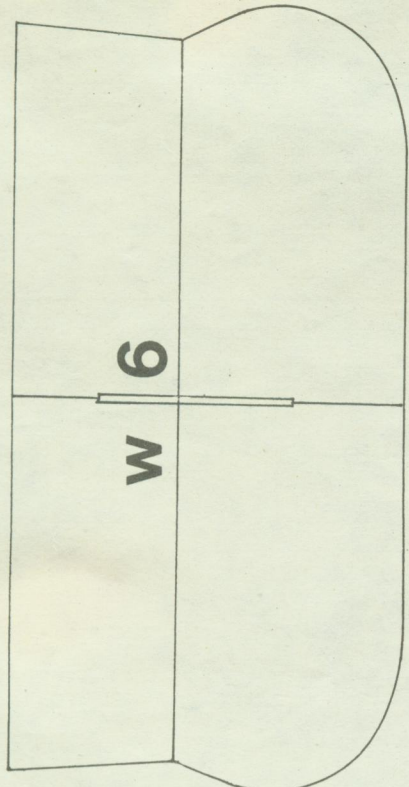
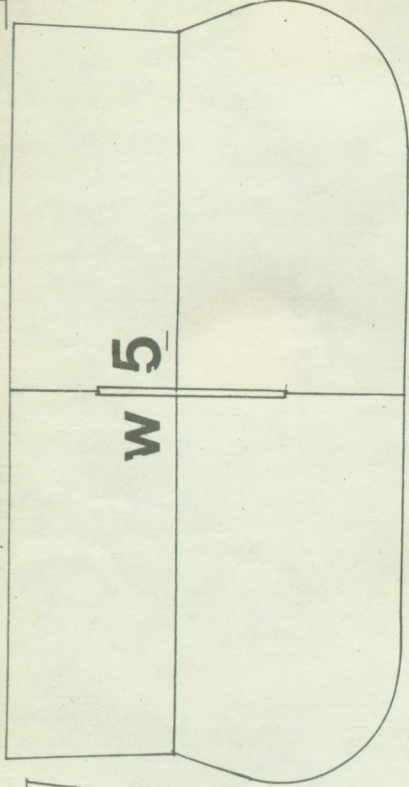

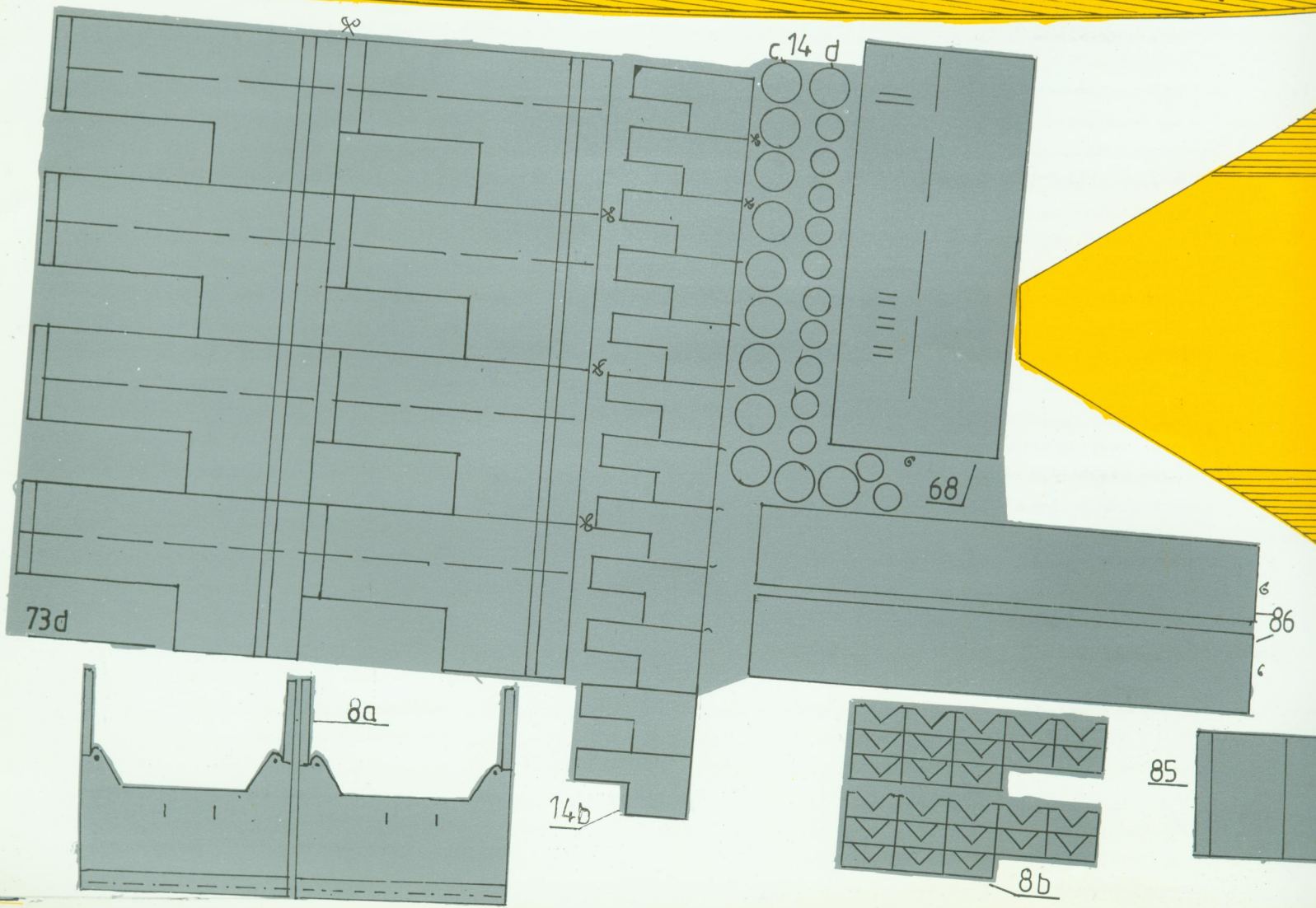
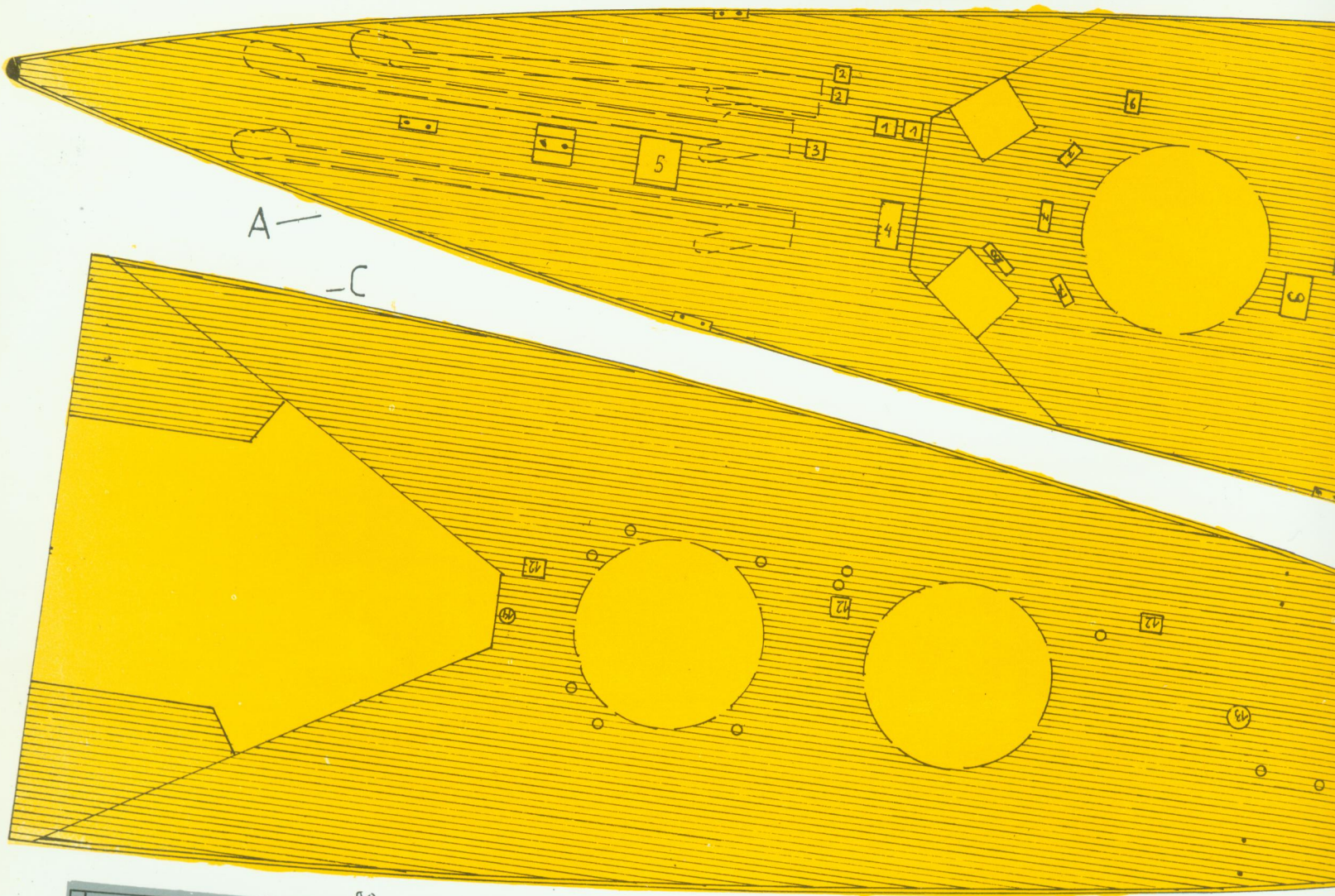

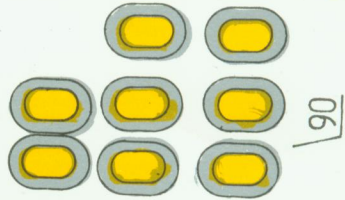
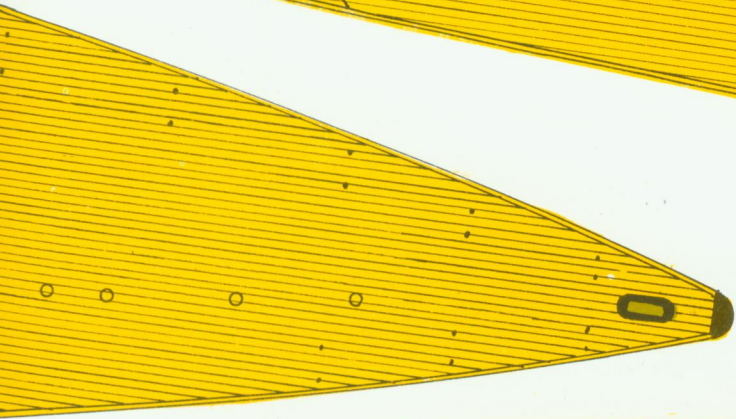
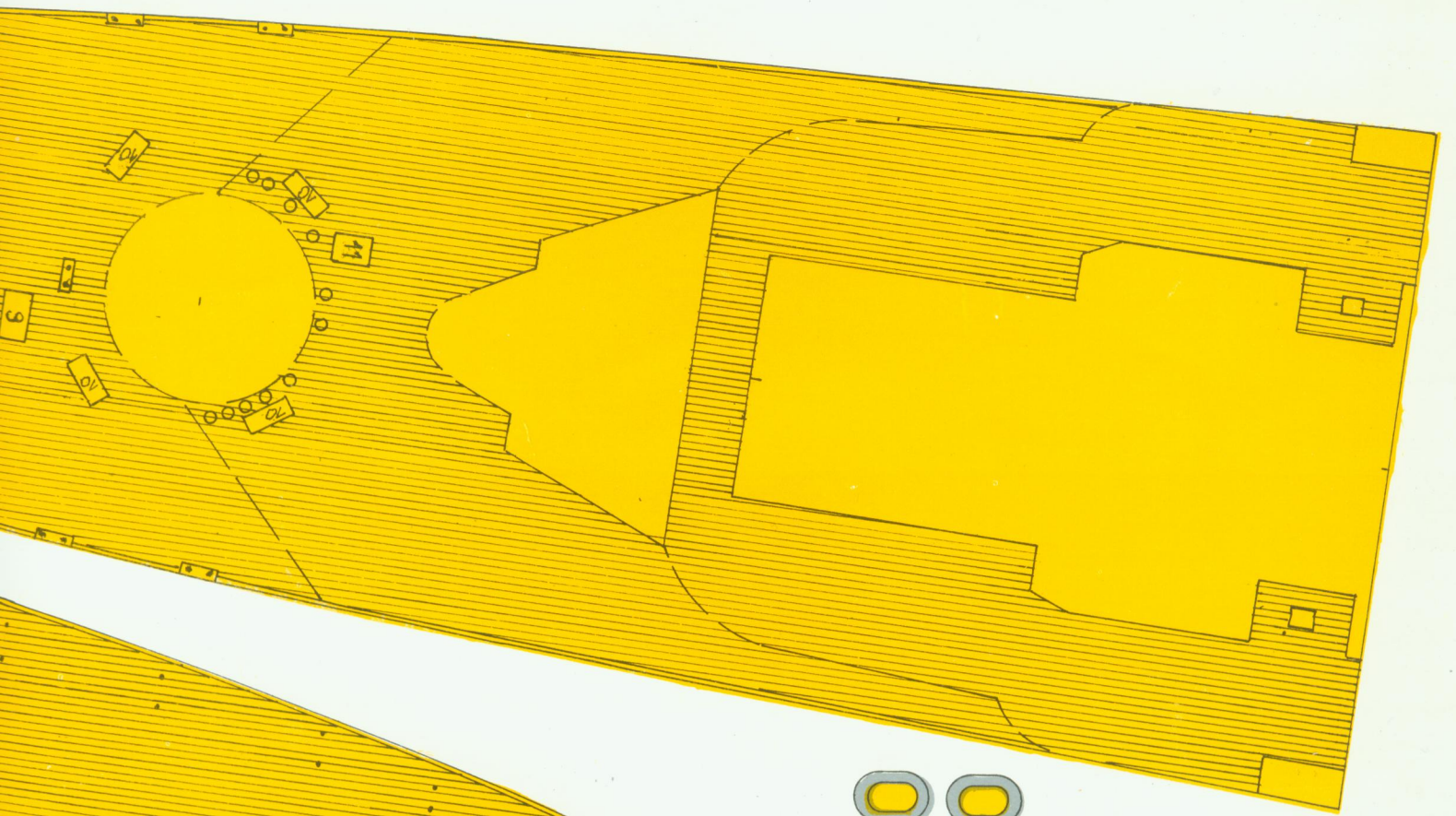

B

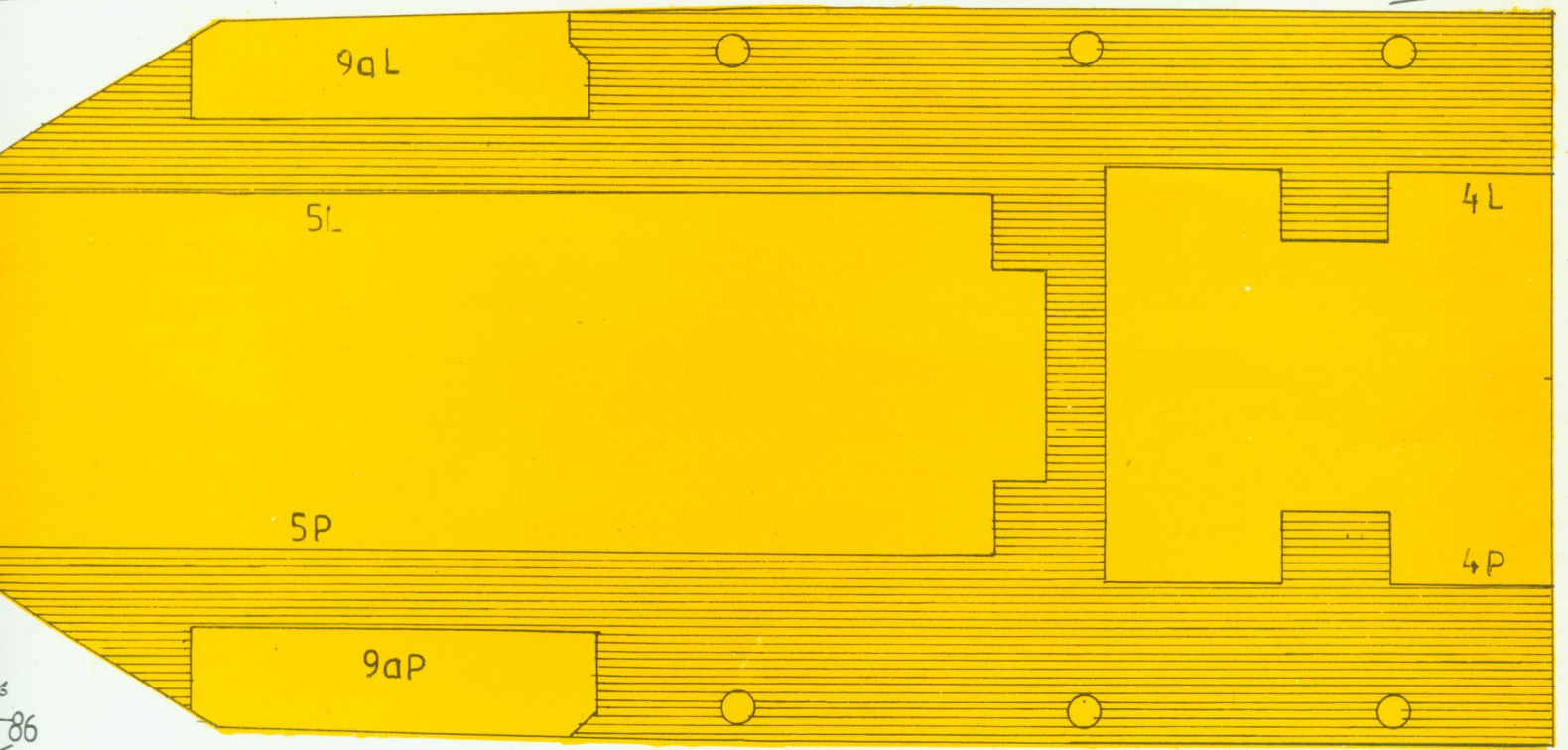

86

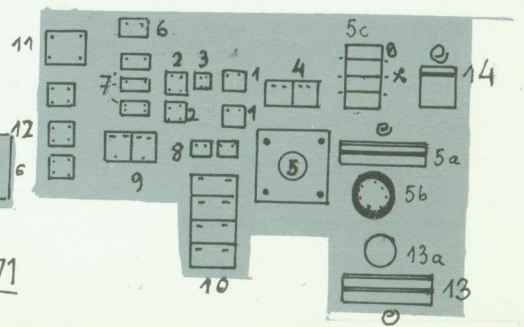
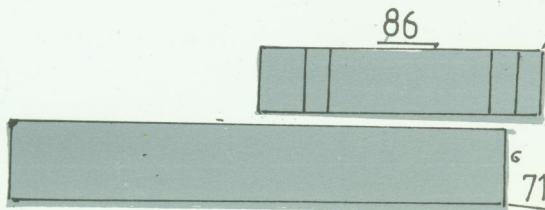
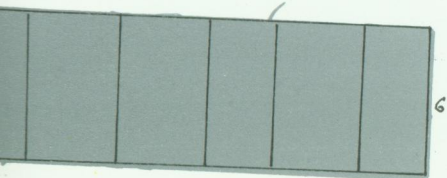

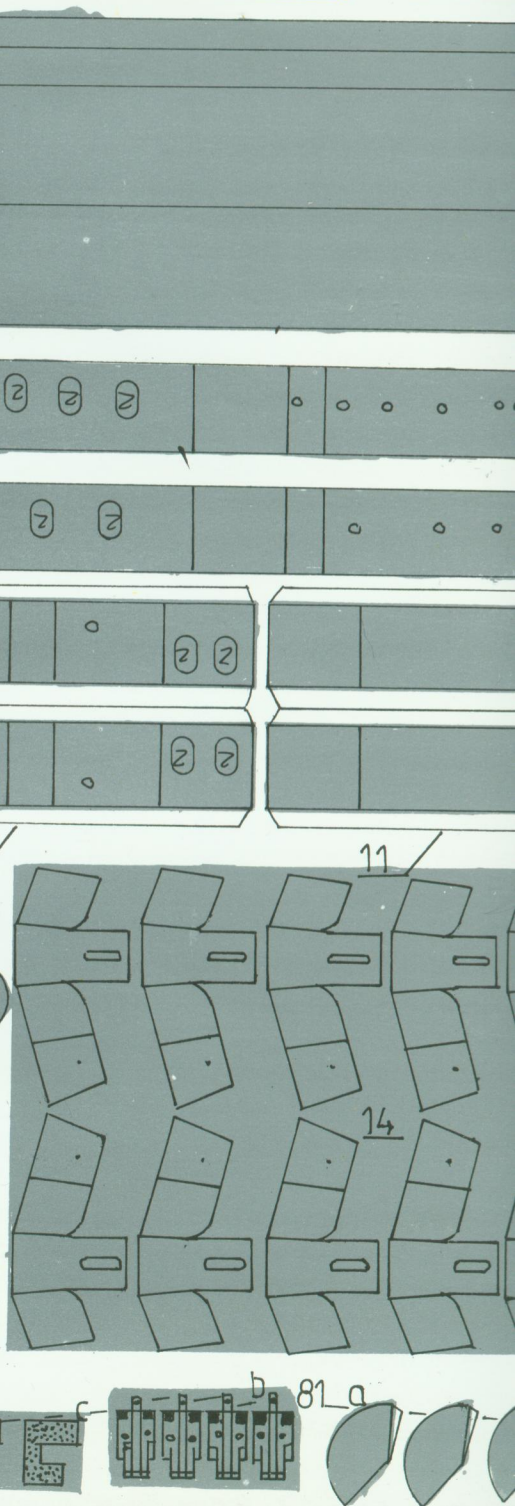
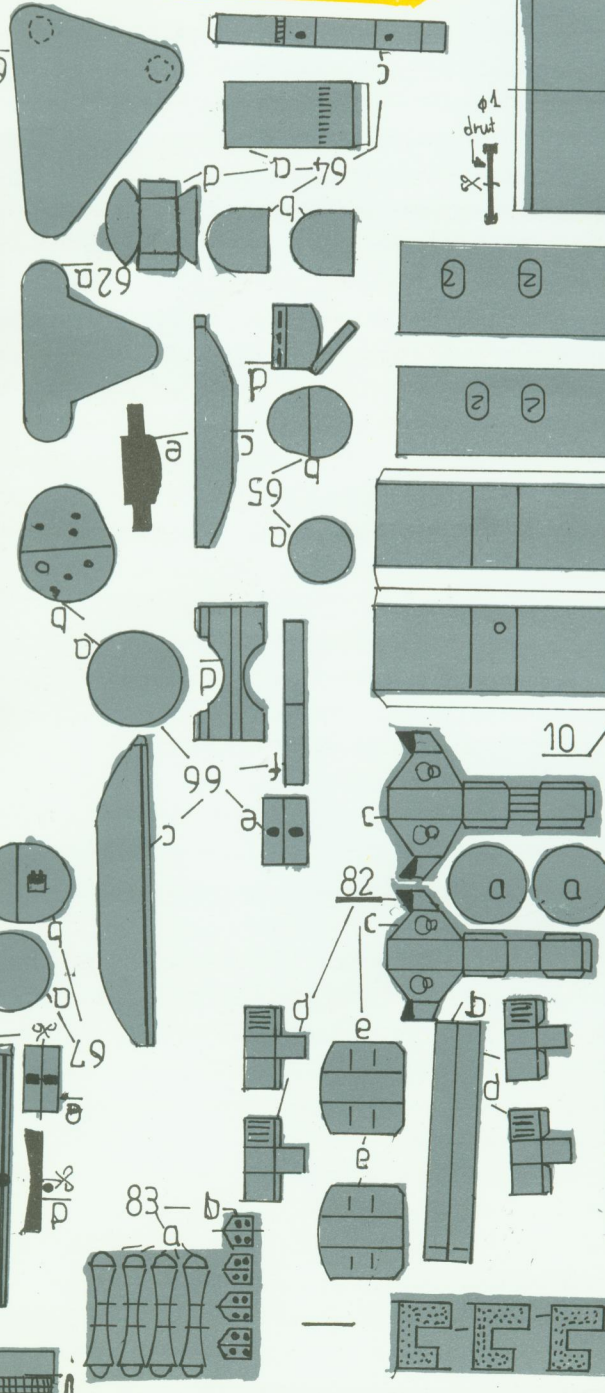
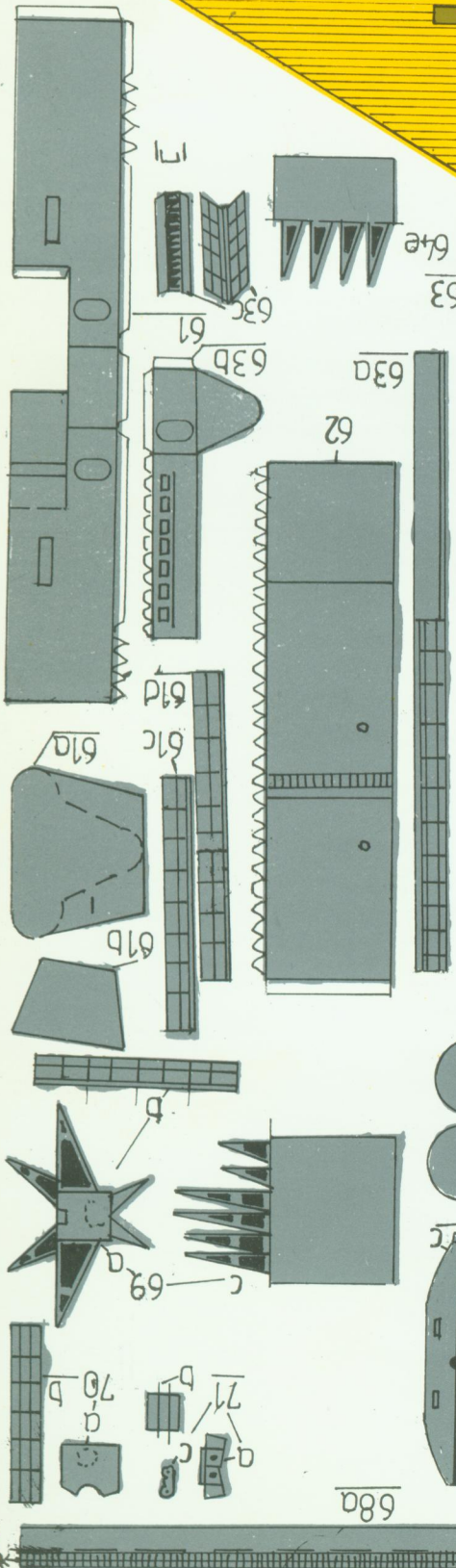
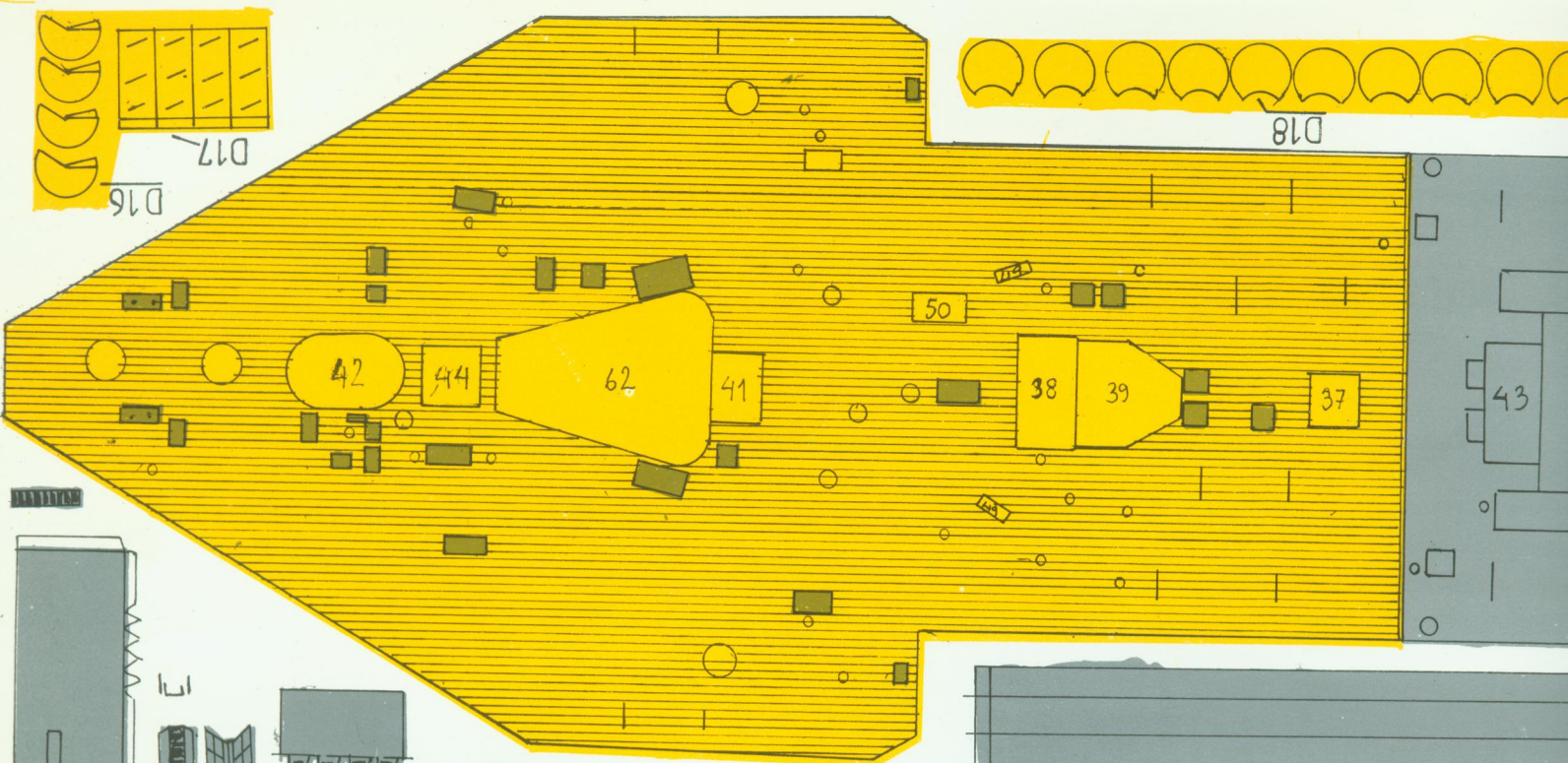

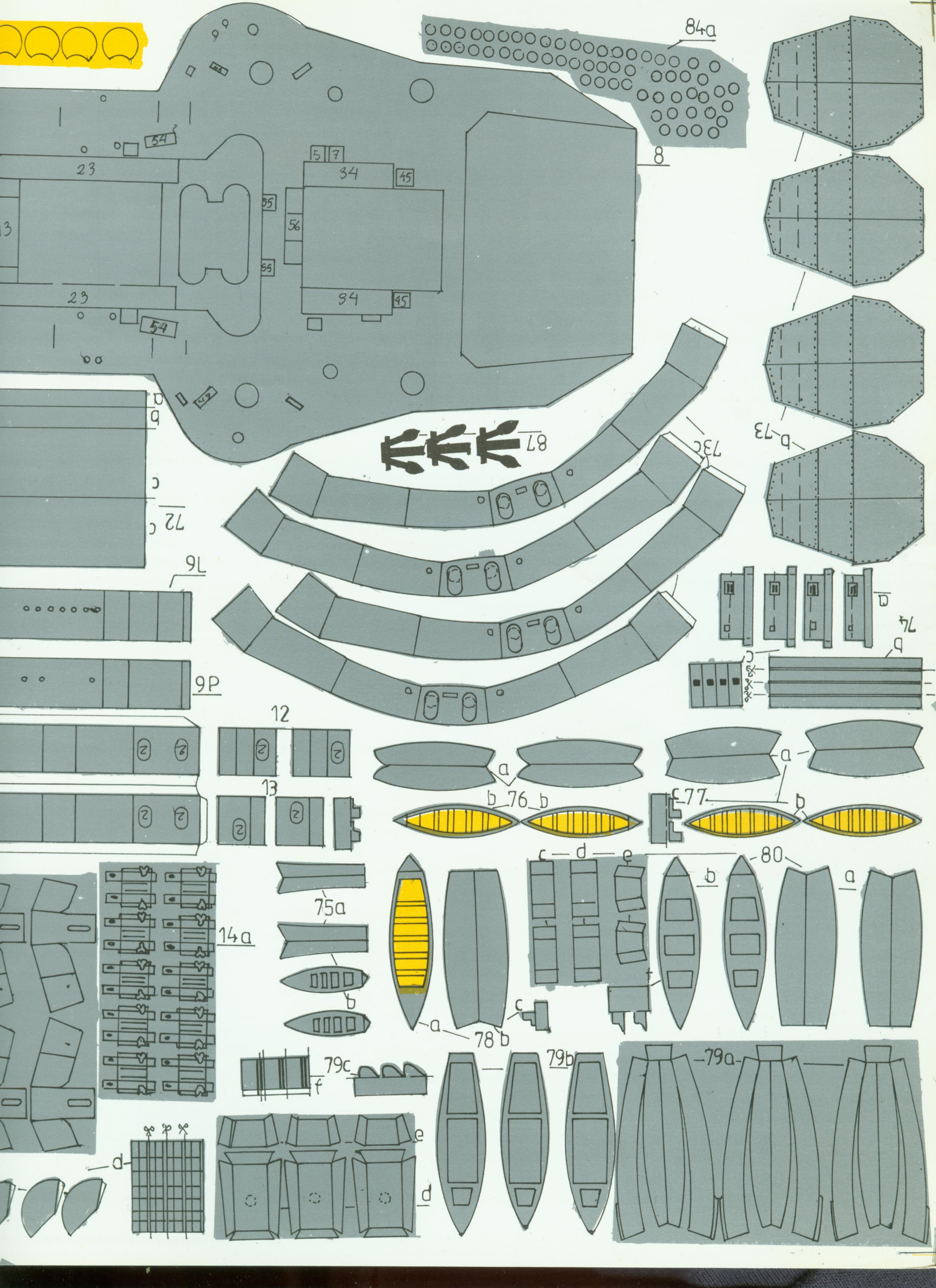

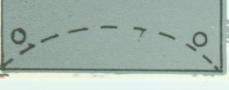
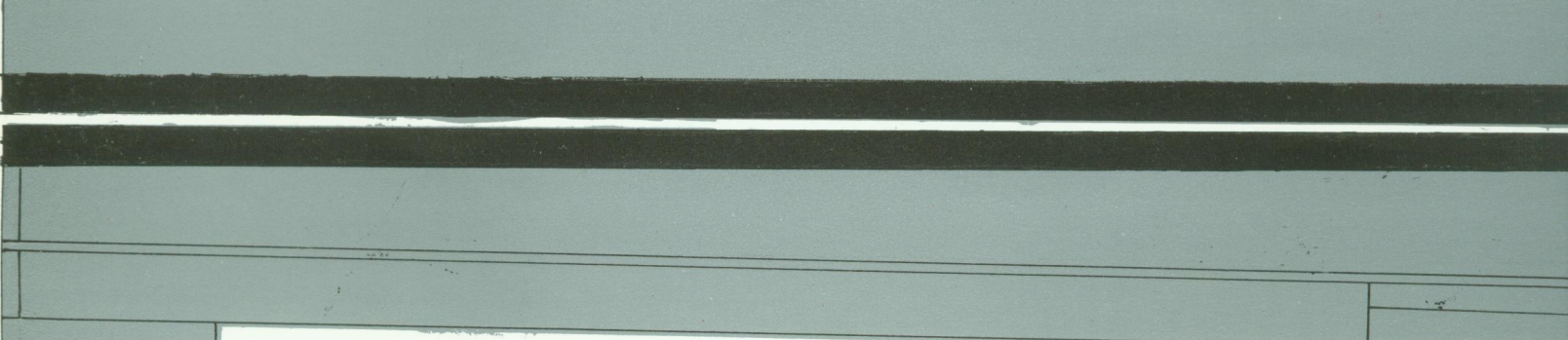
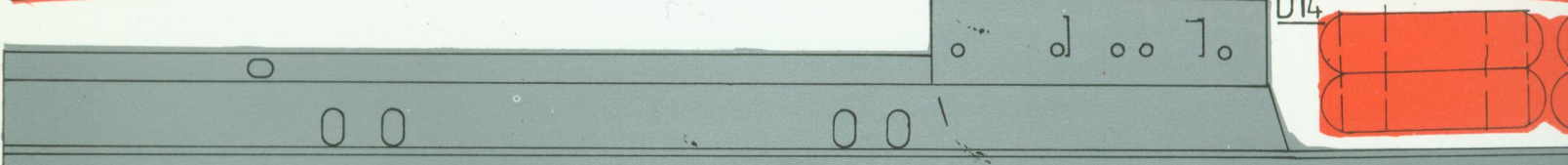
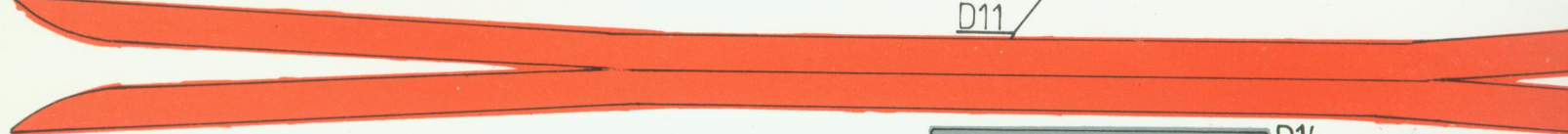
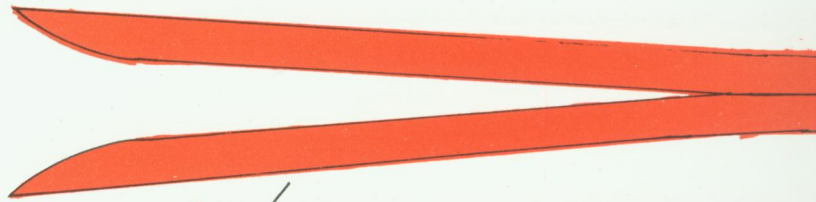
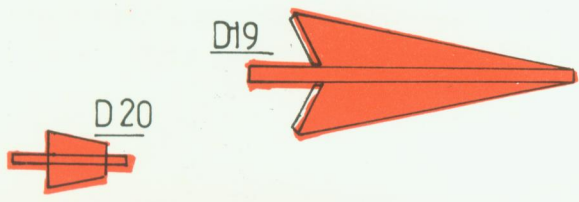
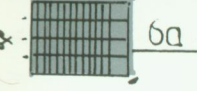
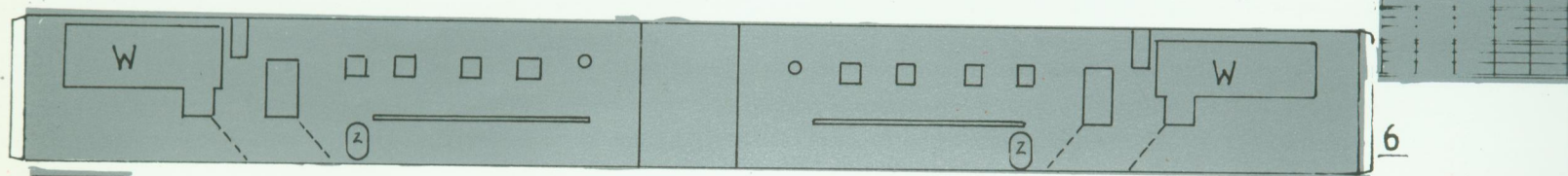
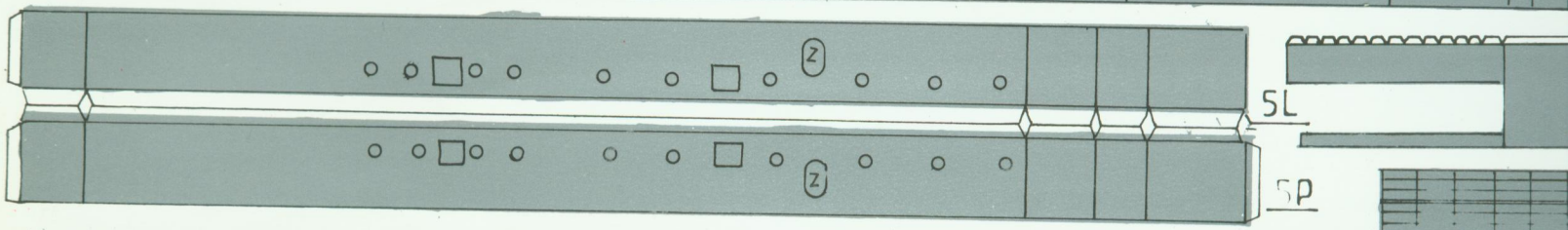
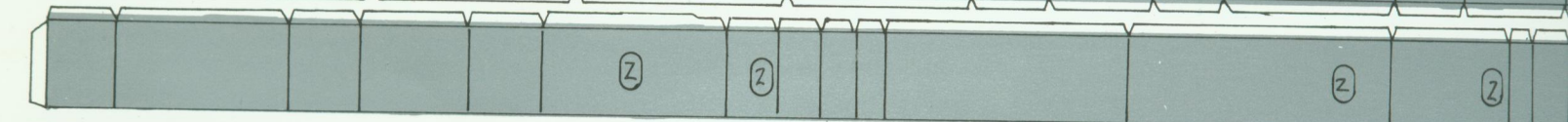
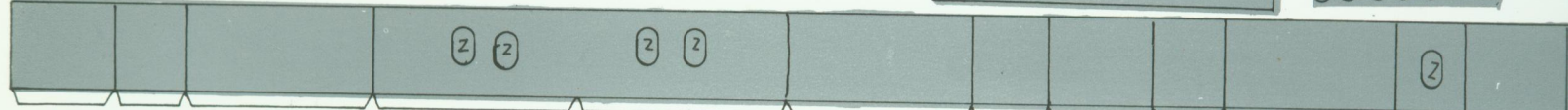
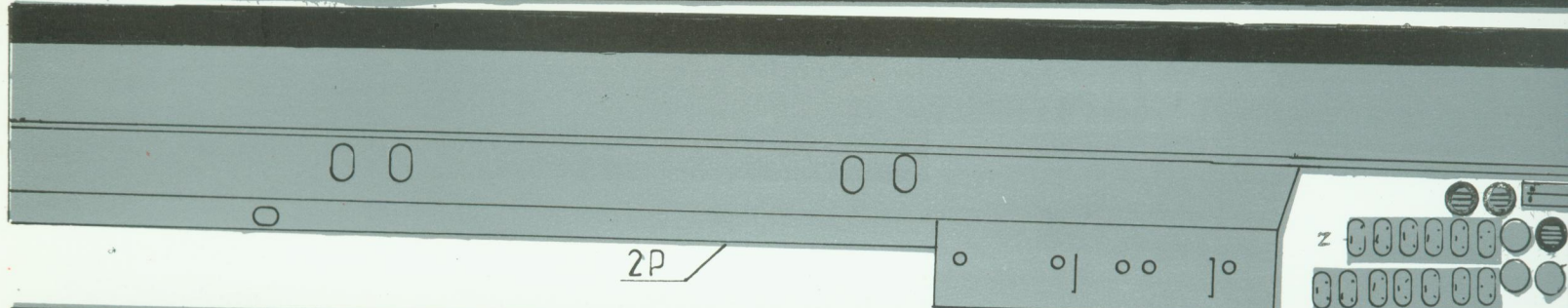
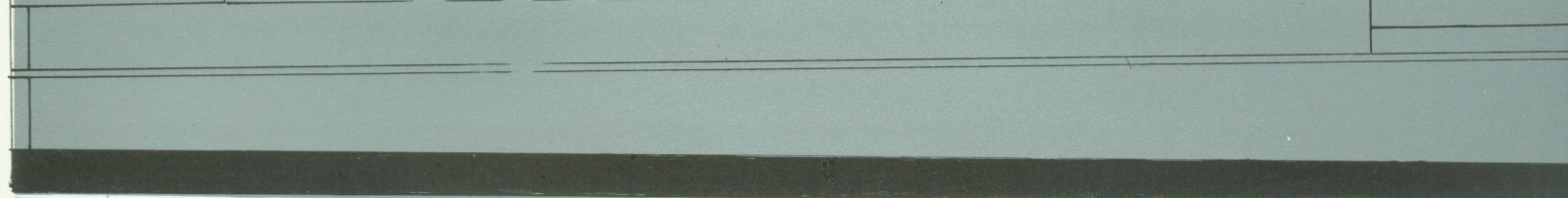

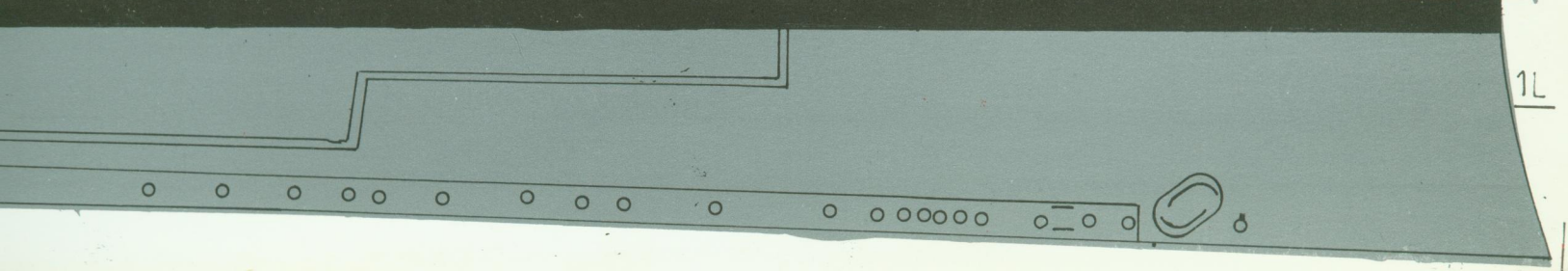
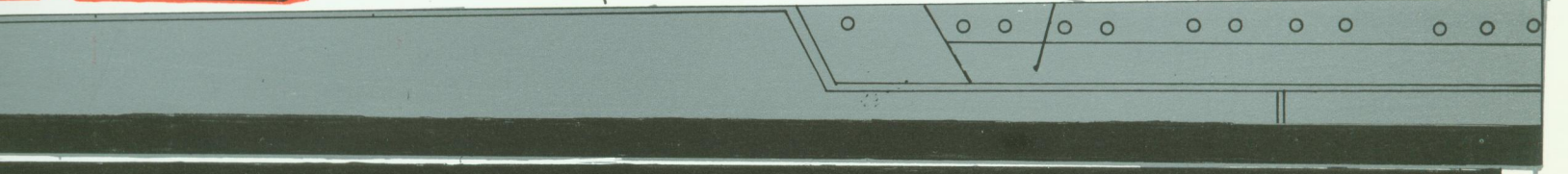
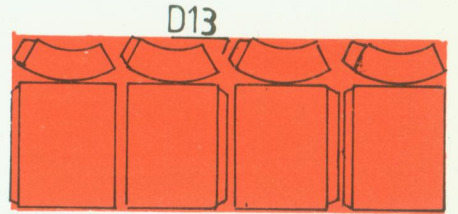
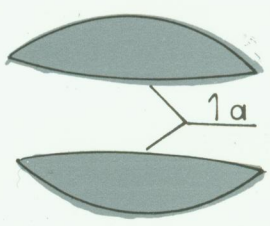
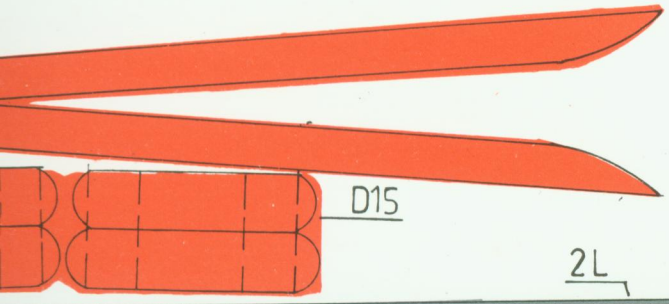
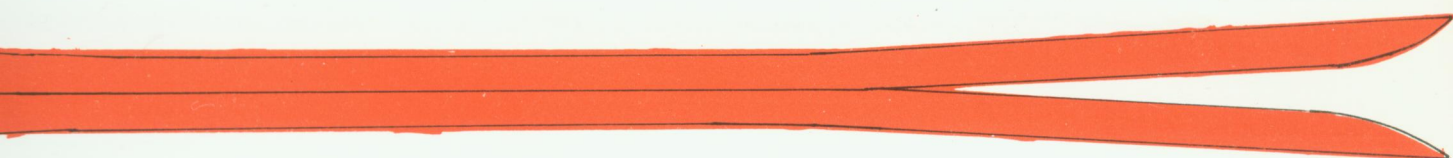
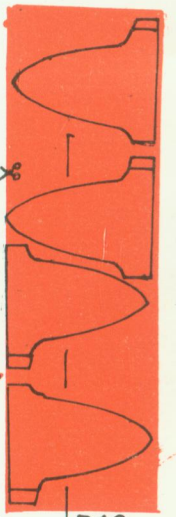
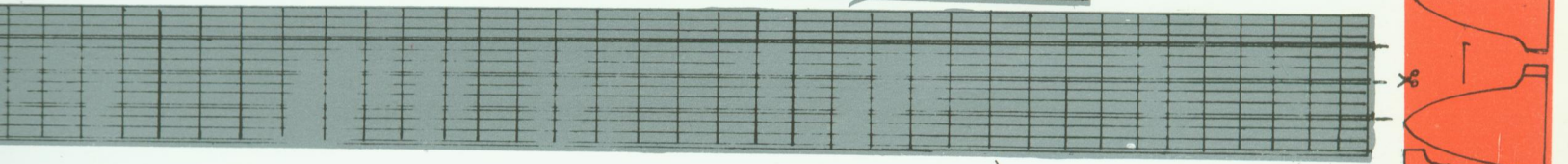
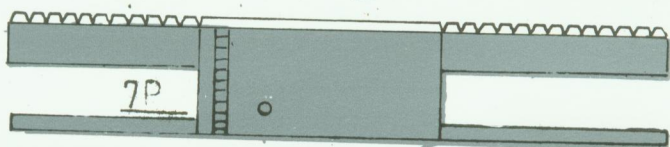
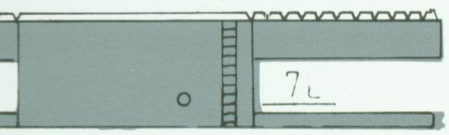
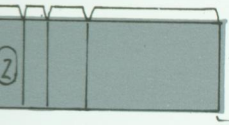
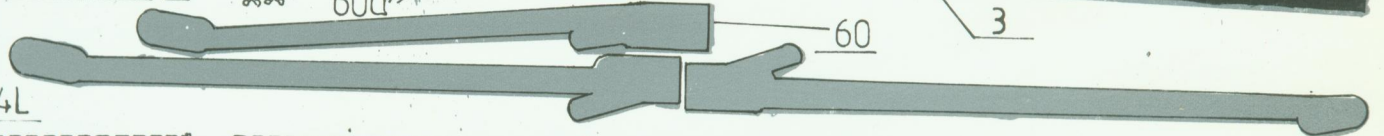
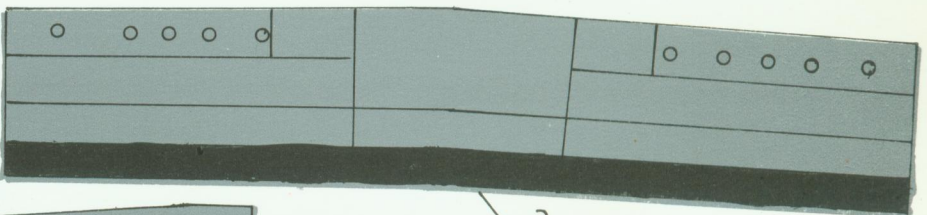
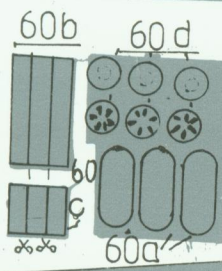
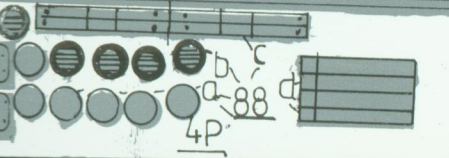
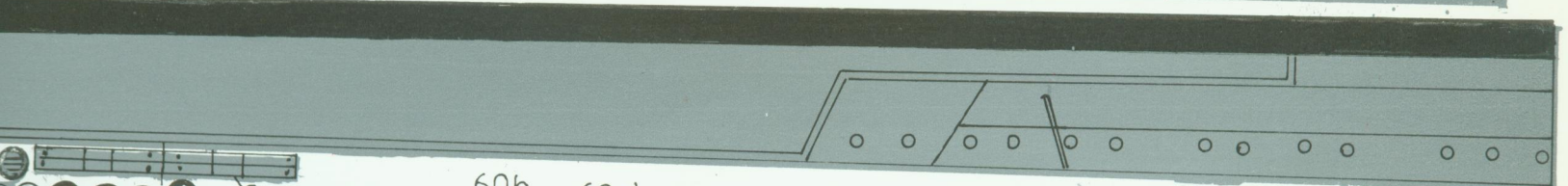
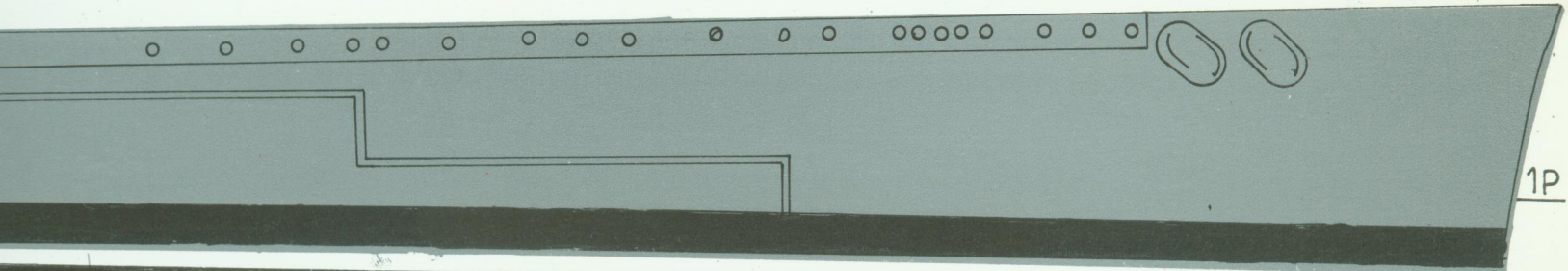

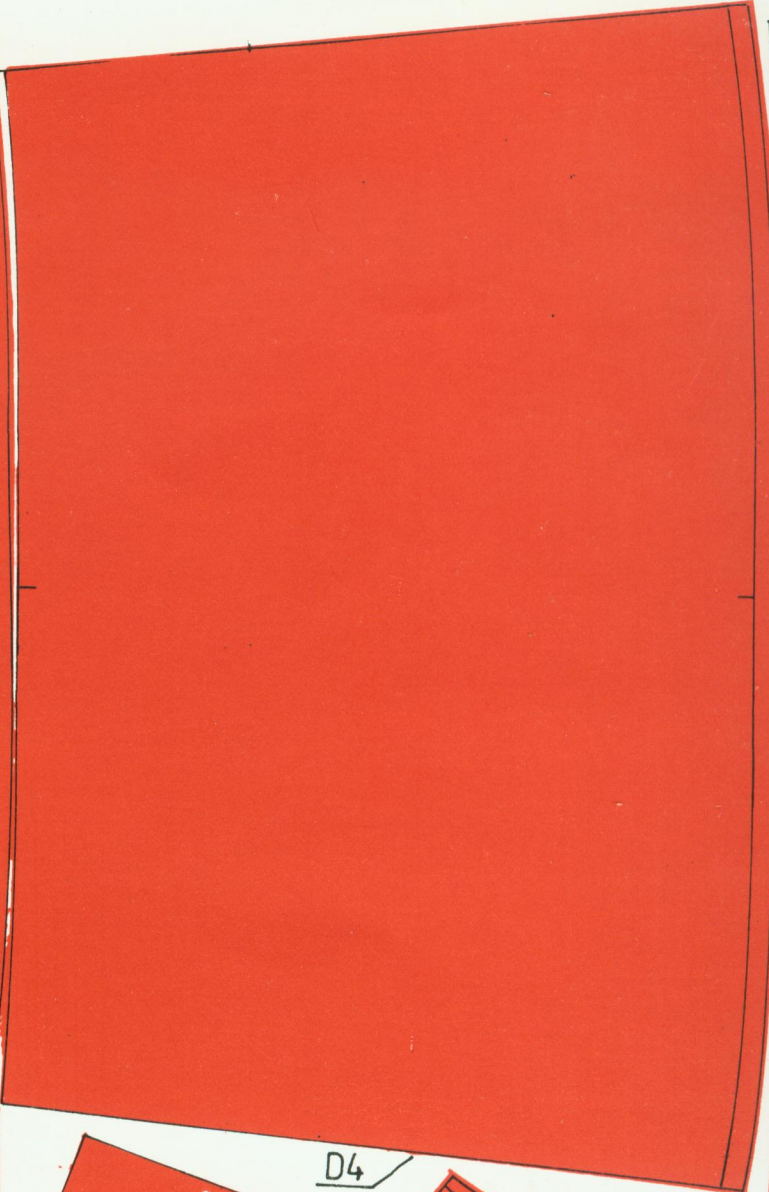

D3

D4

D5

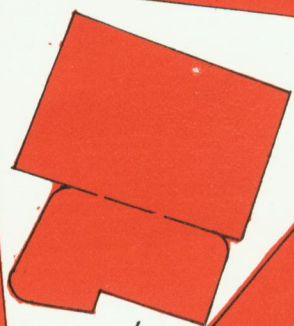

D10



D9

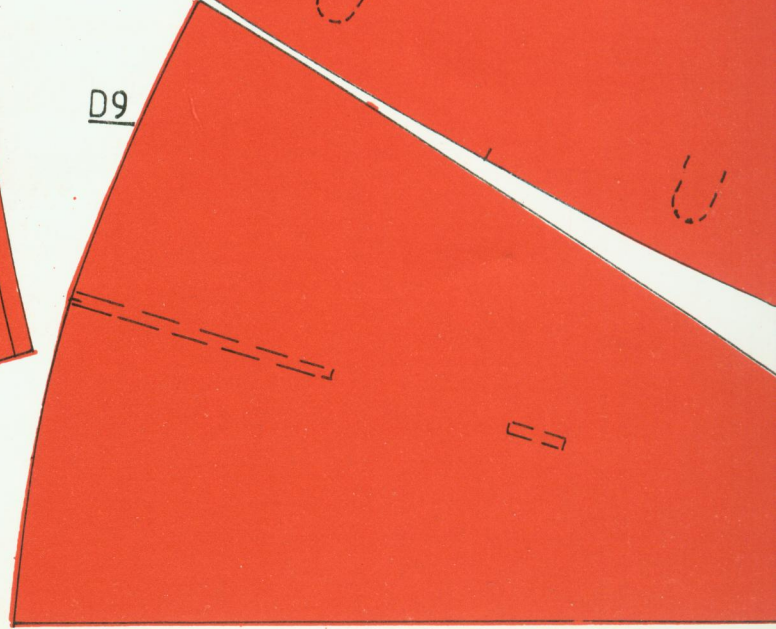

D7

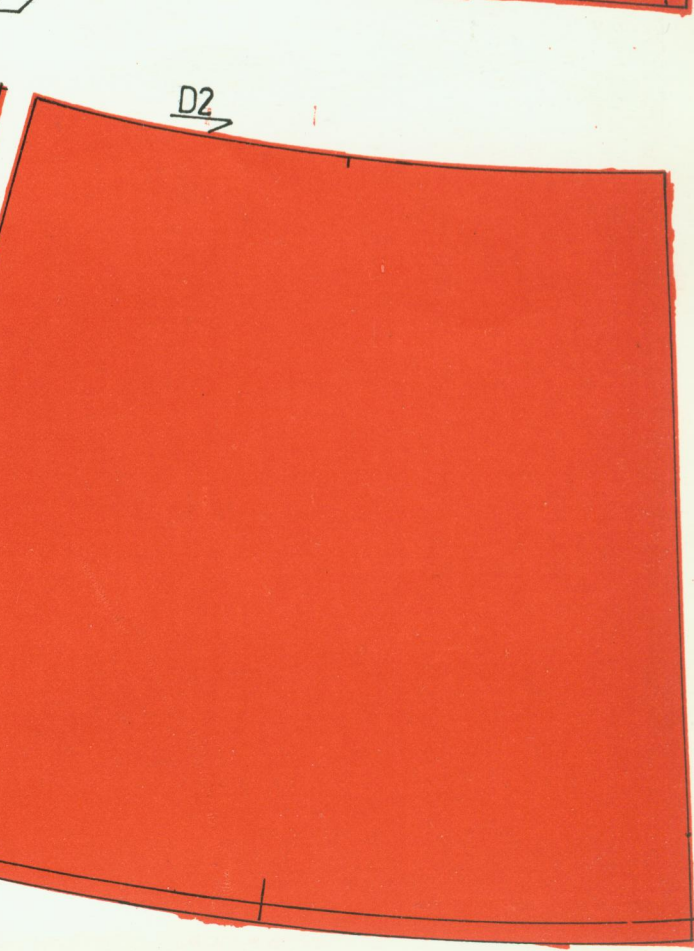
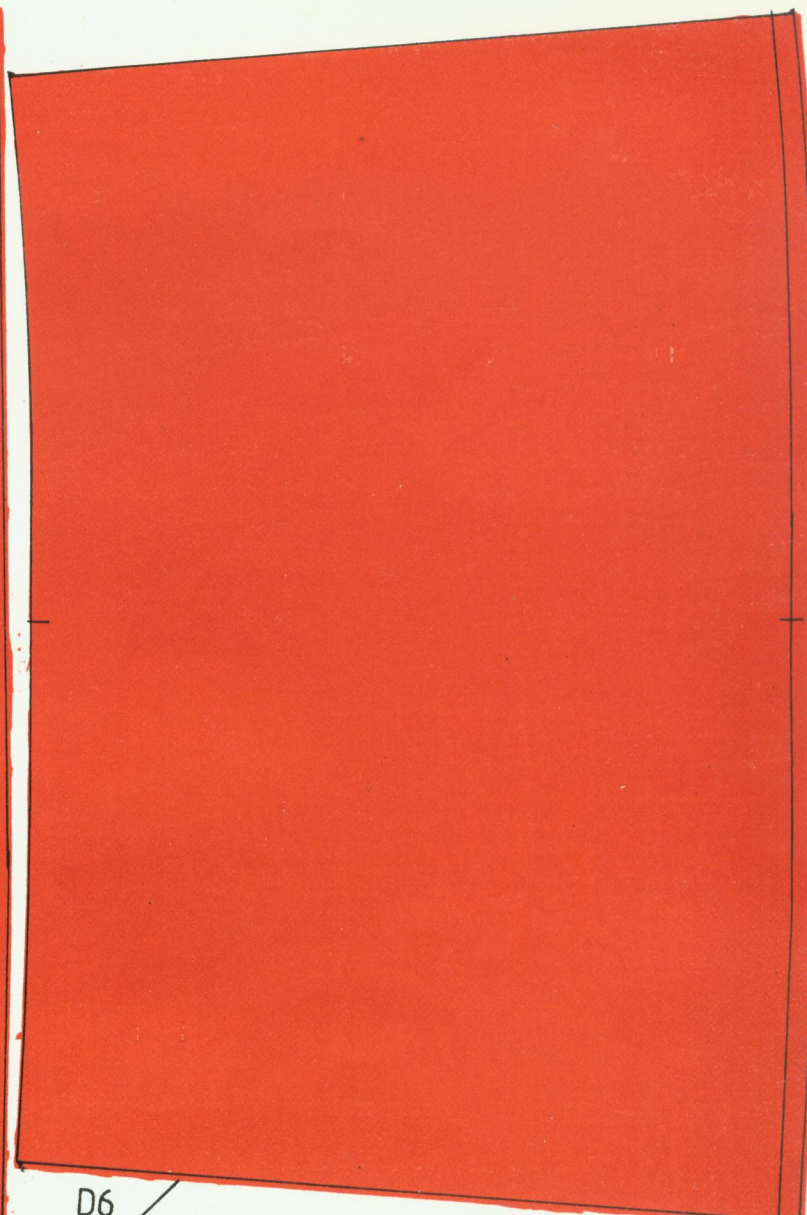
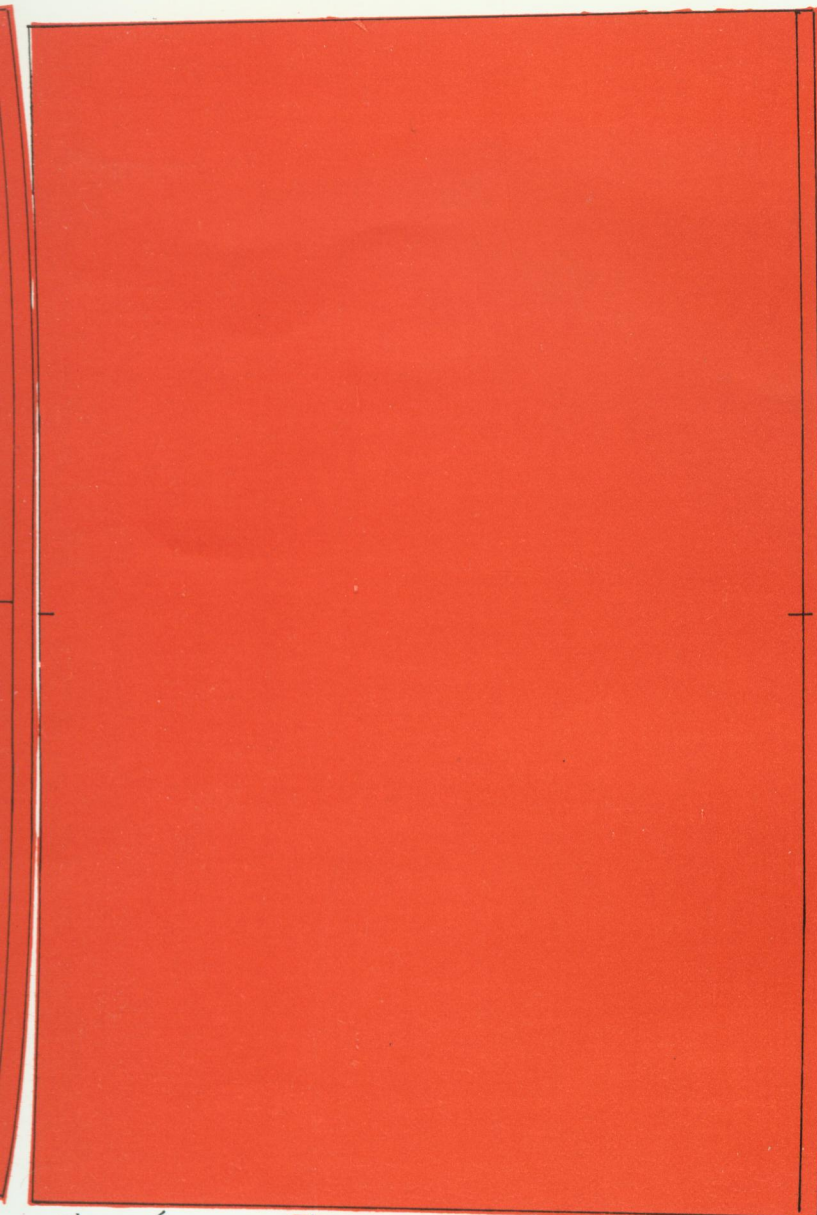

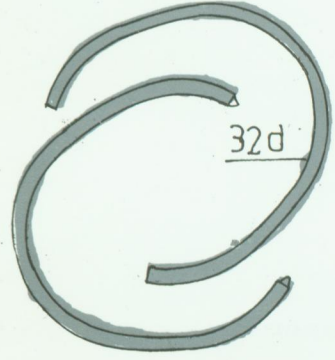
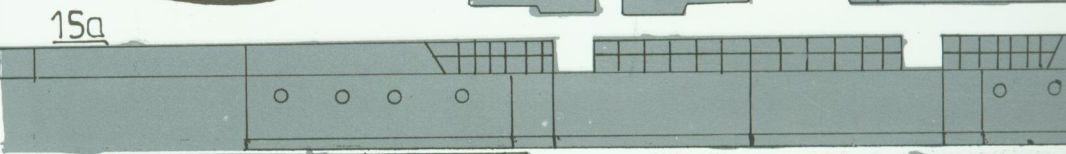
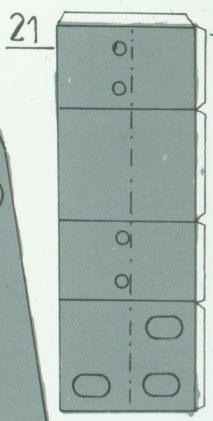
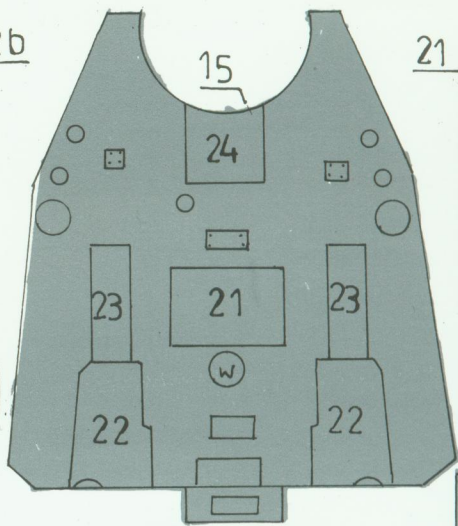
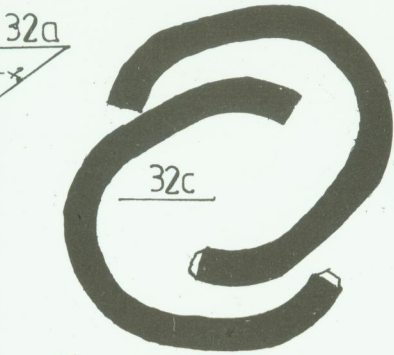
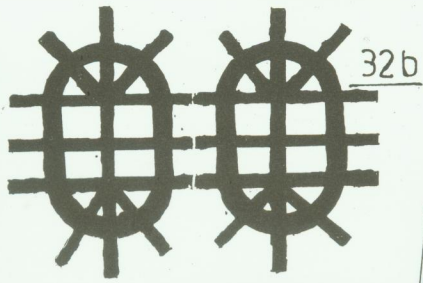
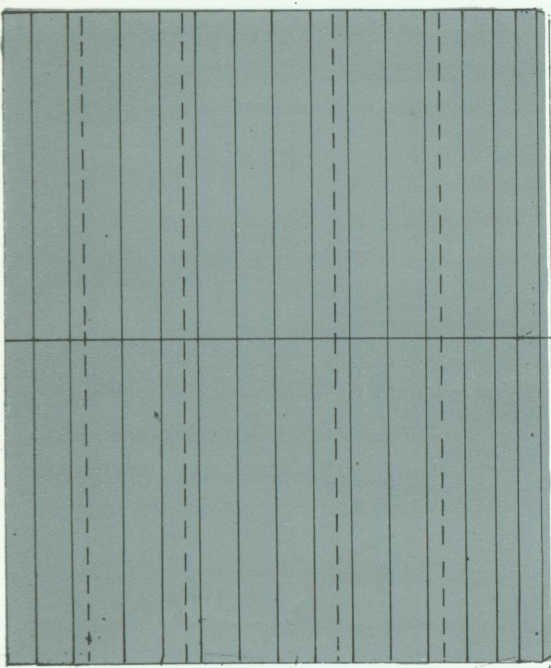

32e

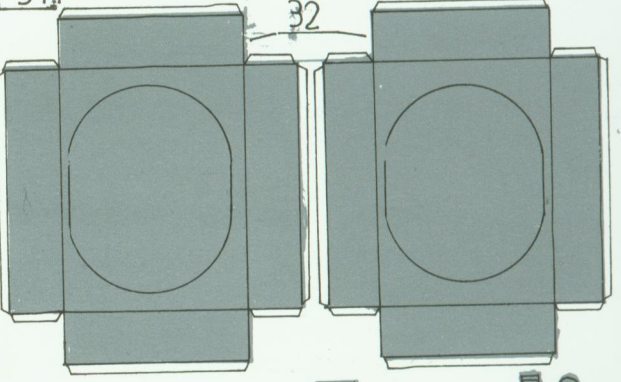
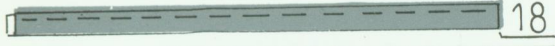
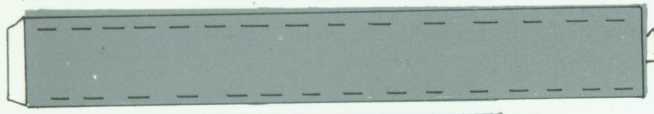
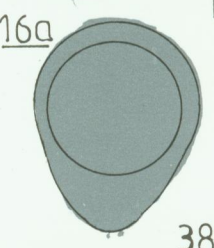
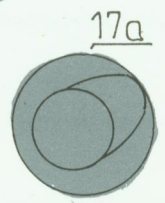
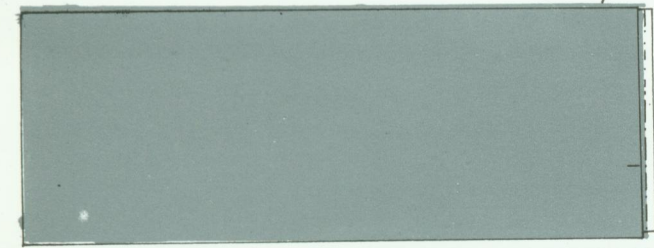
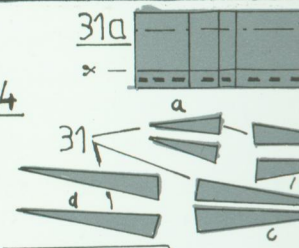
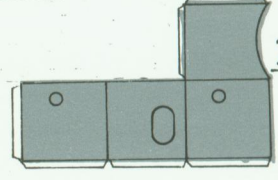
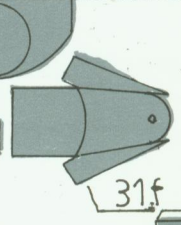
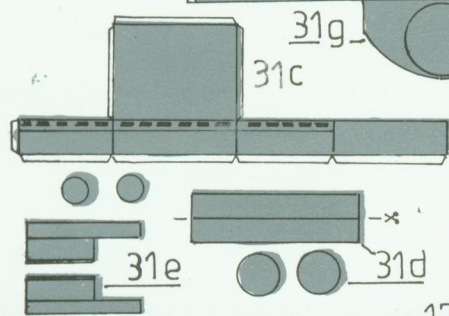

54

