



Welcome, foolish mortal, to The Phantom Manor Paper Model Kit!

**Ray Keim, at Haunted Dimensions, has created this free project solely for entertainment.
It is not to be repackaged or resold.**

KEEP IT FREE!

When completed, the model is approximately 12 inches (30 cm) high, 11 inches (27.5 cm) wide and 13 inches (33.5 cm) deep.

Much time and effort has gone into the creation of this model of the Phantom Manor. The architectural, and artistic details are extremely accurate, however some artistic license was taken, in order to translate the mansion to paper.

Please note that this project is not recommended for children. It requires a moderate degree of skill, and the use of an X-acto blade, which is extremely dangerous. I HIGHLY recommend wearing protective eyewear when using an X-acto blade! Tips can snap and fly!

When printing the model, be sure that your printer is set to print at 100%. Each sheet has a logo, and page number graphic, which can be compared with other sheets, to ensure that all of your pieces are printed at a uniform size. Color printing is recommended.

There are many pages to print, so be sure you have enough paper and ink! This model was designed to be printed on EPSON Matte Paper Heavyweight. Using plain paper is not recommended.

The files are in .pdf format, so you will need a computer with Adobe Acrobat Reader installed.

I recommend using white glue, and applying it with a toothpick. Don't use too much glue! Needle-nose tweezers are also very useful.

Become acquainted with the various pieces, and study the directions before you begin. The text instructions that accompany the illustrations are limited, so you will need a keen eye and a good sense of spatial orientation to assemble the Phantom Manor.

There are many folds in the model, and it is recommended that you score the fold first, using a dull X-acto, or other fine, blunt tipped instrument. Black dashed lines represent a mountain fold (a fold which point upward), and orange dashed lines represent a valley fold (the fold points downward). The orange dashed lines are accompanied by a red "+" at each end. These are to be used as pin guides to poke small holes at the "+", flip the sheet over, and score between the holes for a clean valley fold.

To avoid confusion, after cutting out a part, lightly write the part numbers on the back with a pencil.

I created this model for my own enjoyment, but choose to share it with others. By downloading this model, you agree that the success of the final product is primarily determined by the patience and skill of the builder.

Have fun building your Phantom Manor, and good luck!
Bonne Chance!

There's no turning back now!

<http://www.haunteddimensions.raykeim.com/>



Fold indicators: - - - - - = mountain fold (points to you)
+ - - - - + = valley fold (points away from you)

To make a valley fold
use a pin to poke a hole
at each red +

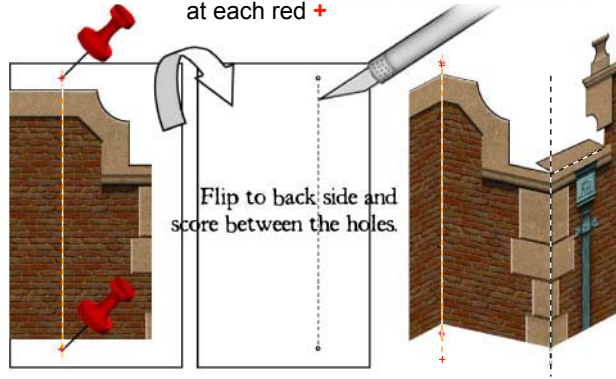

Score and assemble the mansion walls. Be sure to cut all slots wide enough to allow easy tab insertions (a single cut may not be wide enough).

If you choose to cut out the windows, be sure to attach the second floor shutters BEFORE gluing the window inserts.

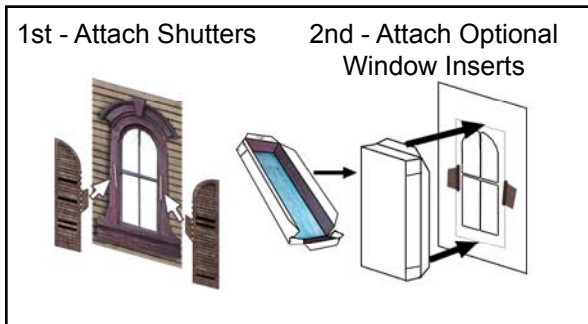
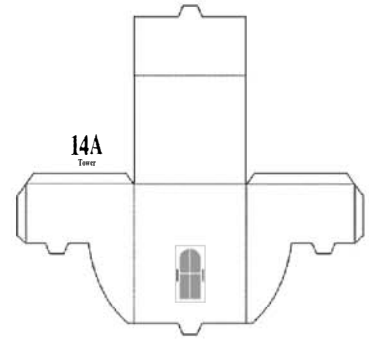
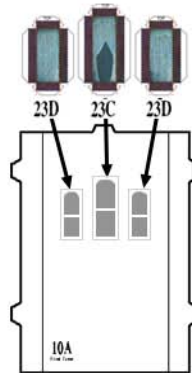
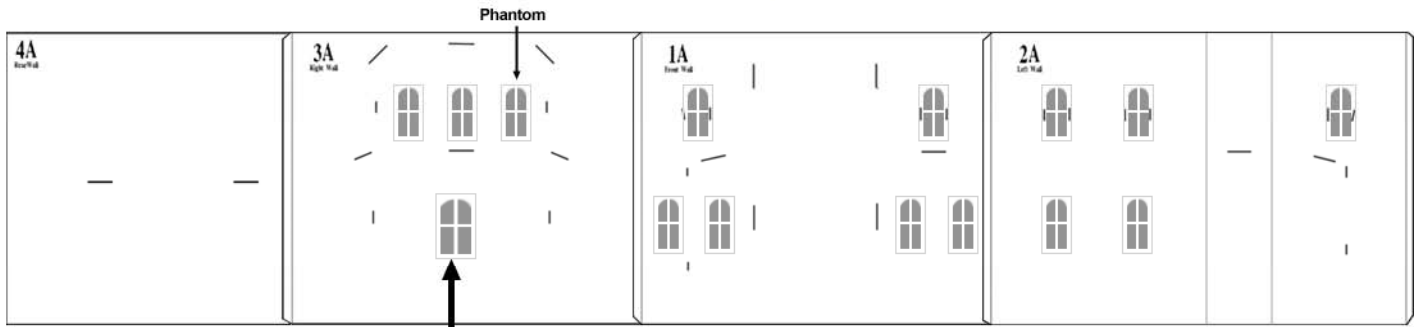
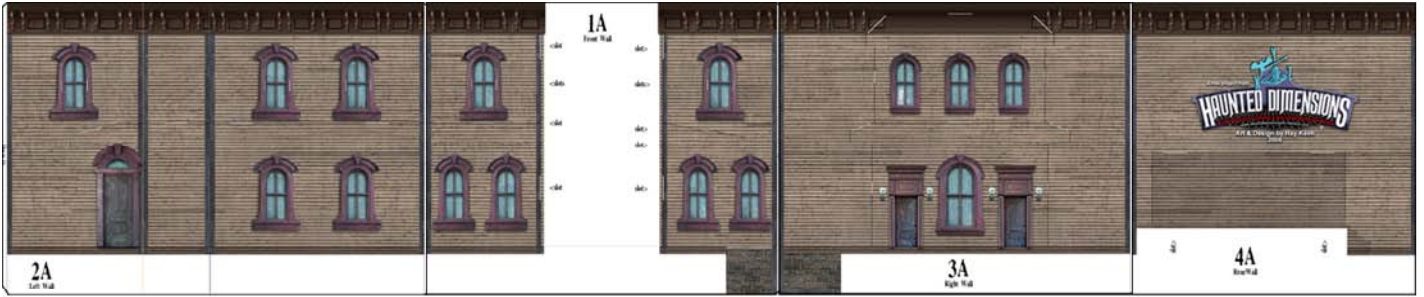

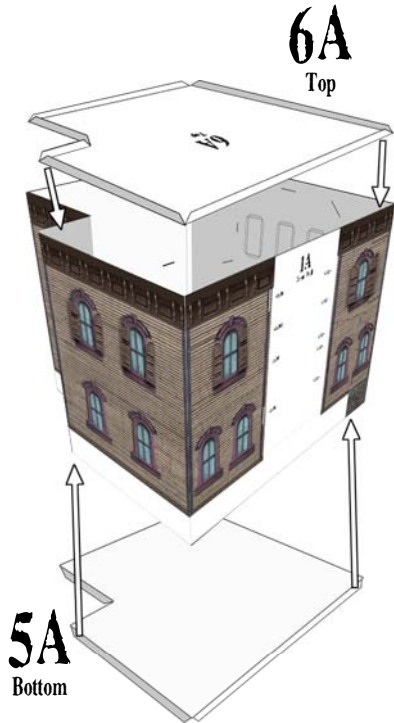

Attach top and bottom supports.
6A (top) and 5A (bottom)

Glue close to edges.

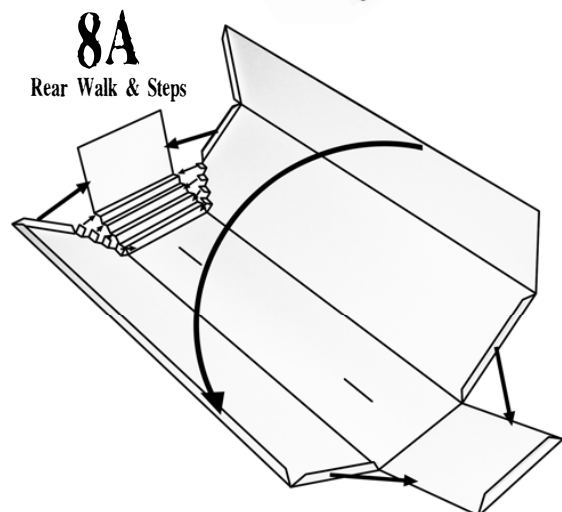
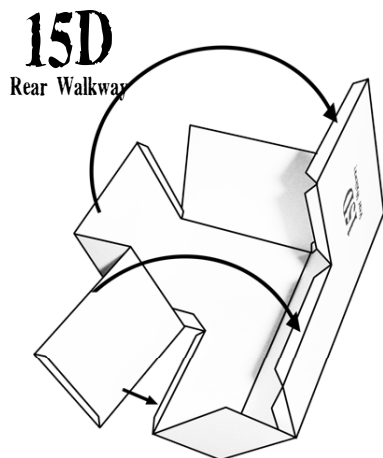
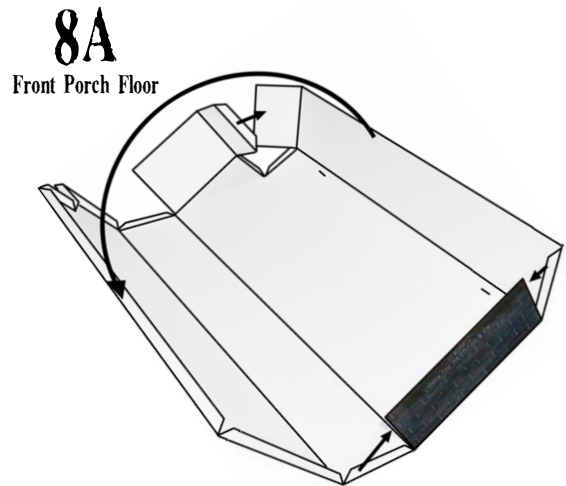
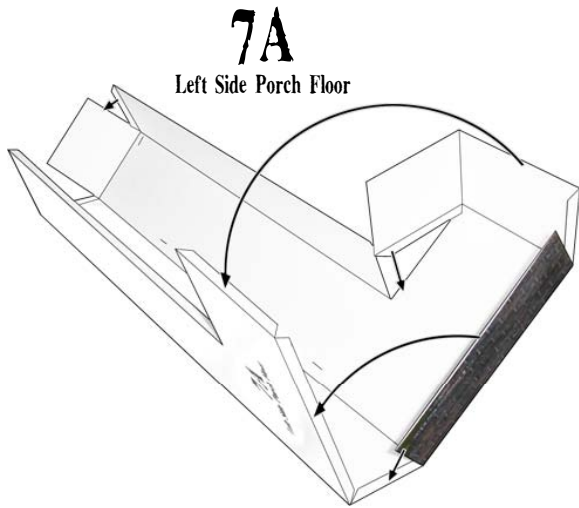
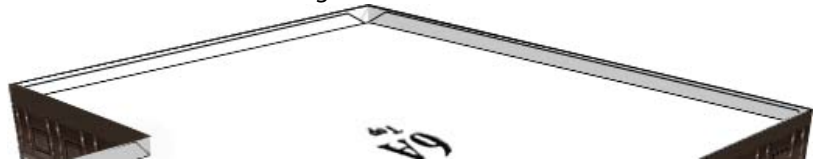



19H
Right Side Steps

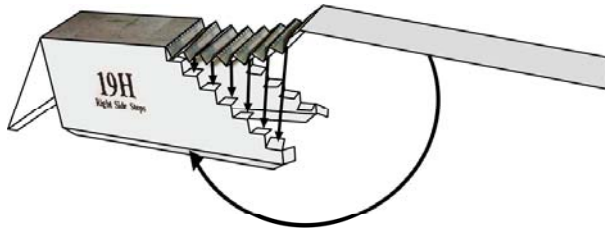

15B **15C** **20D**
Front Right Steps Front Left Steps Rear Corner Steps

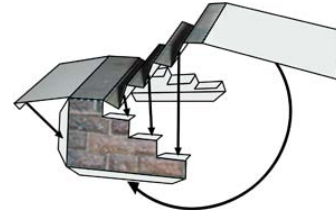

15A
Front Center Steps

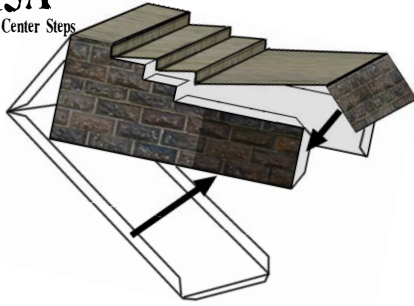

10E
Right Side Steps Wall



10D
Left Front Steps Wall

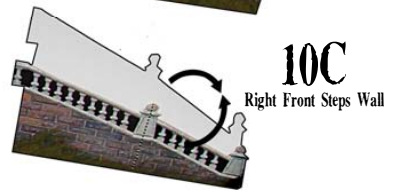
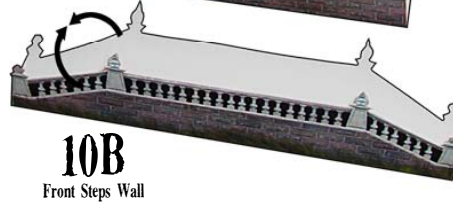

Attach 7A first, then attach 8A and 15D.

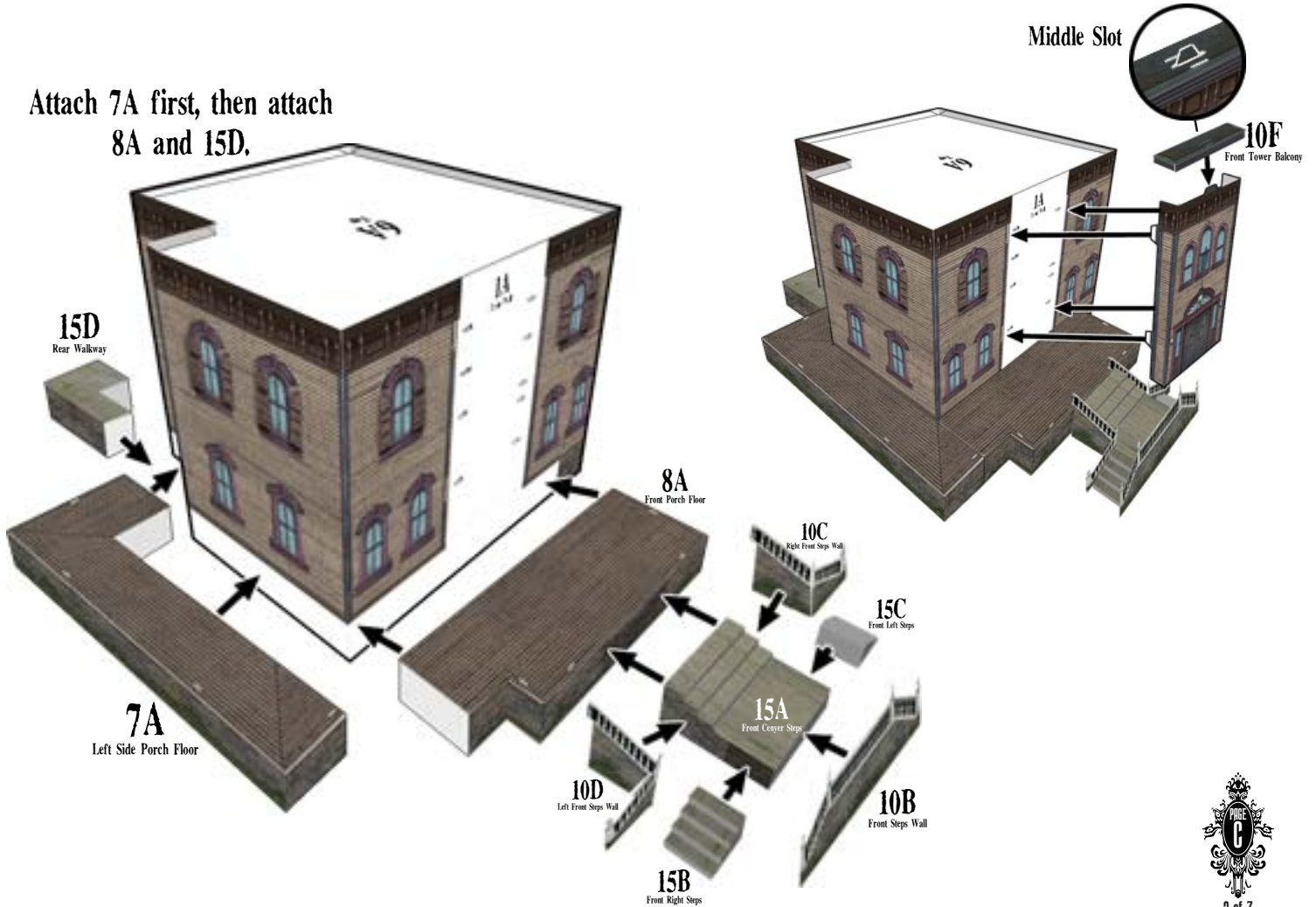

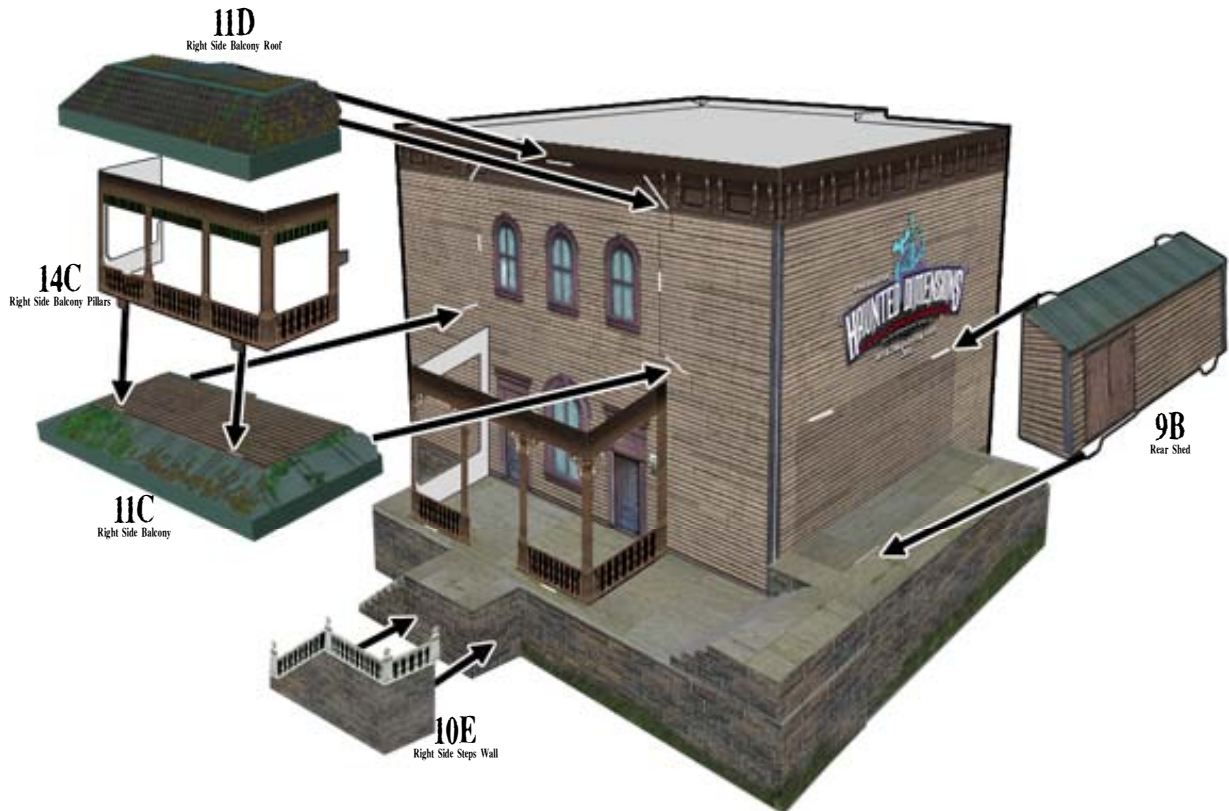
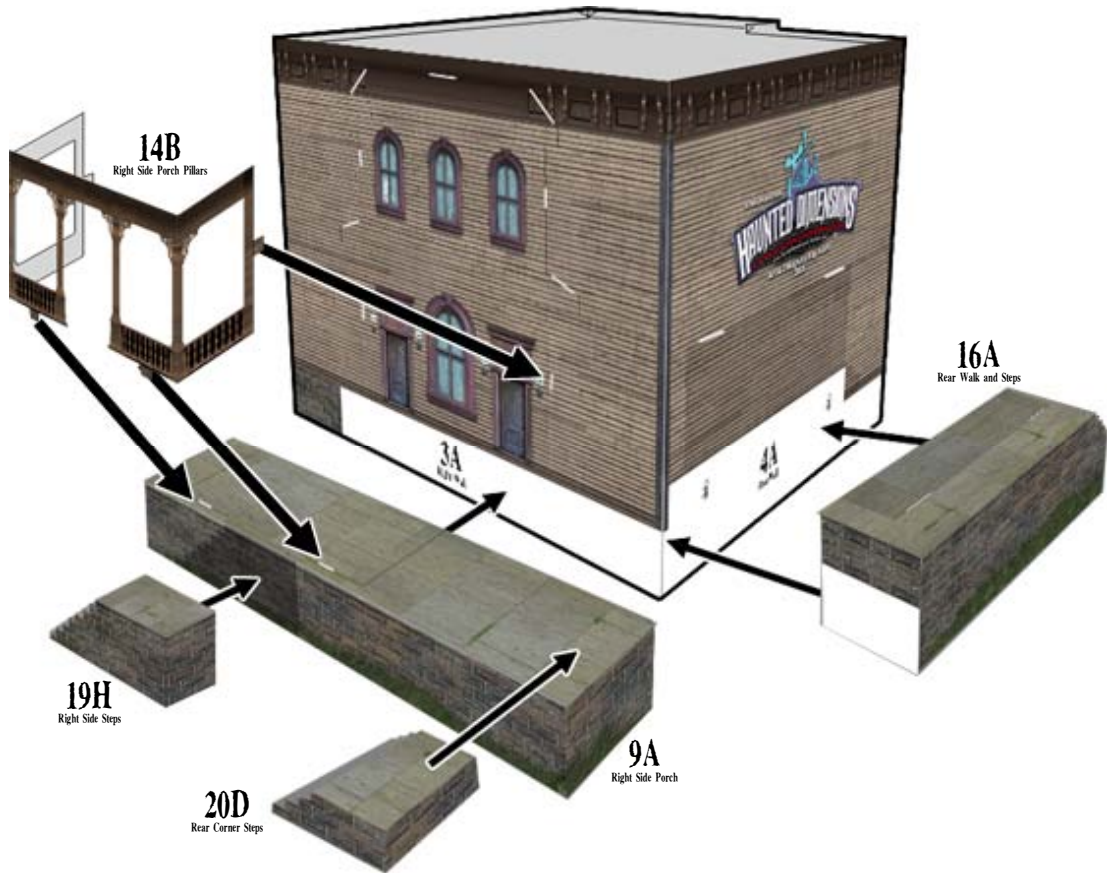

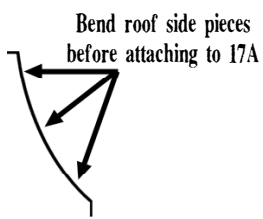
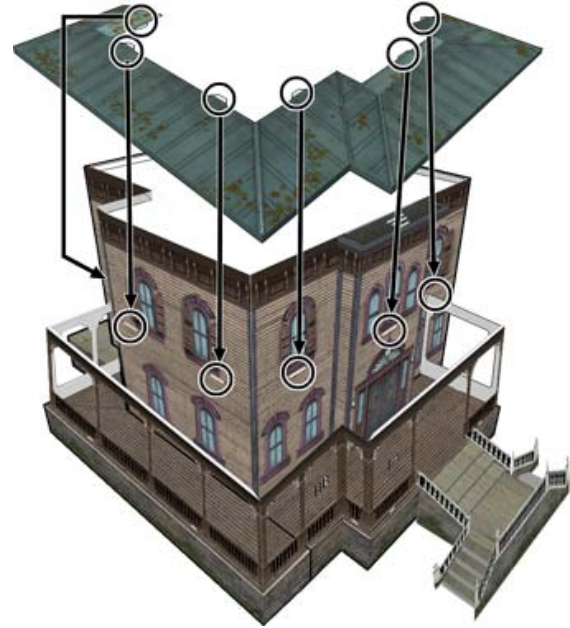
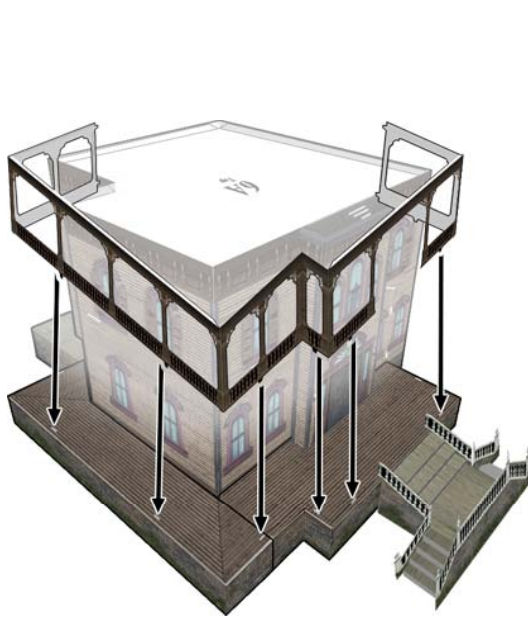
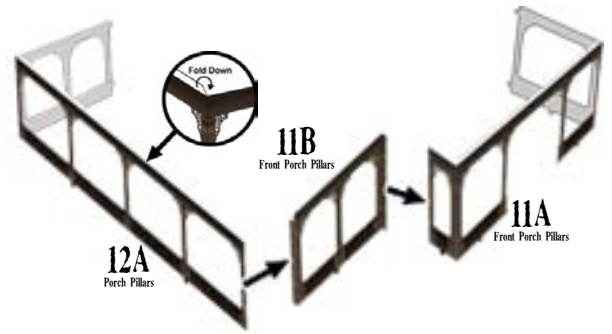
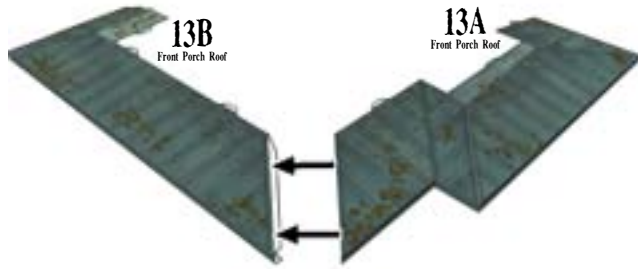

Glue support 17B across 17A as shown

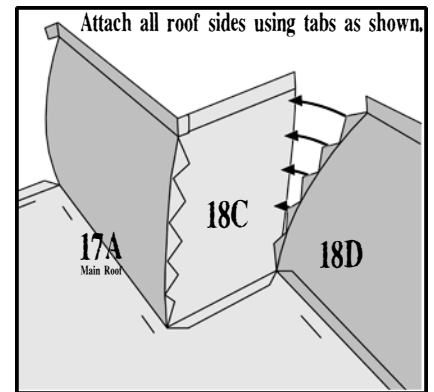
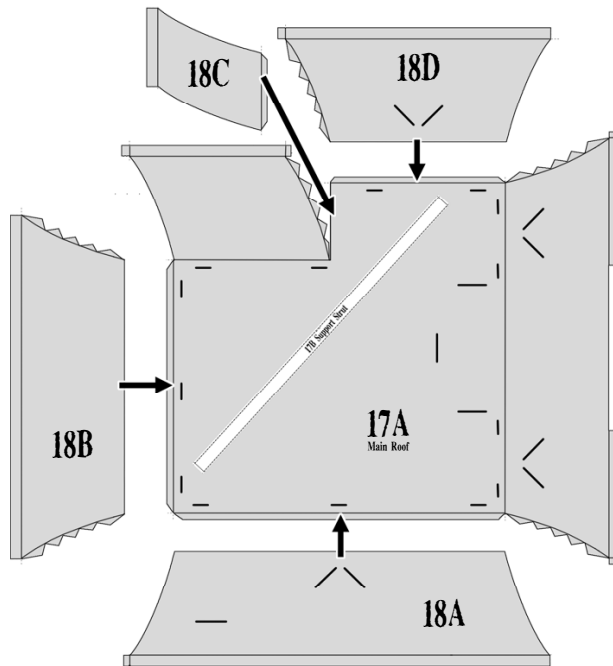
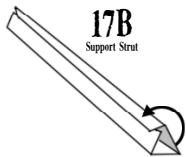



19B
Tower Roof Top

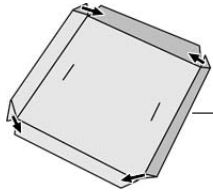

12E
Tower Crest



12G
Lightning Rod

19A
Tower Roof

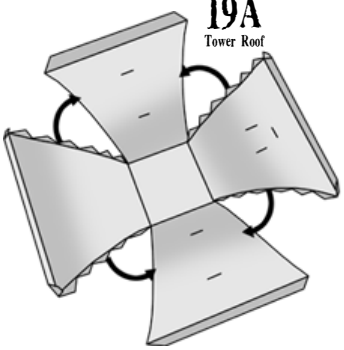

14A
Tower

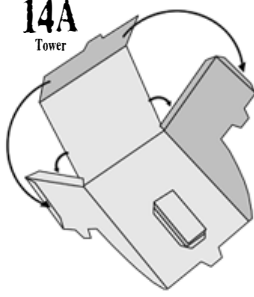

19E
Front Tower Dormer

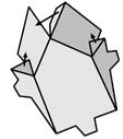

19Cx2
Tower Side Dormers

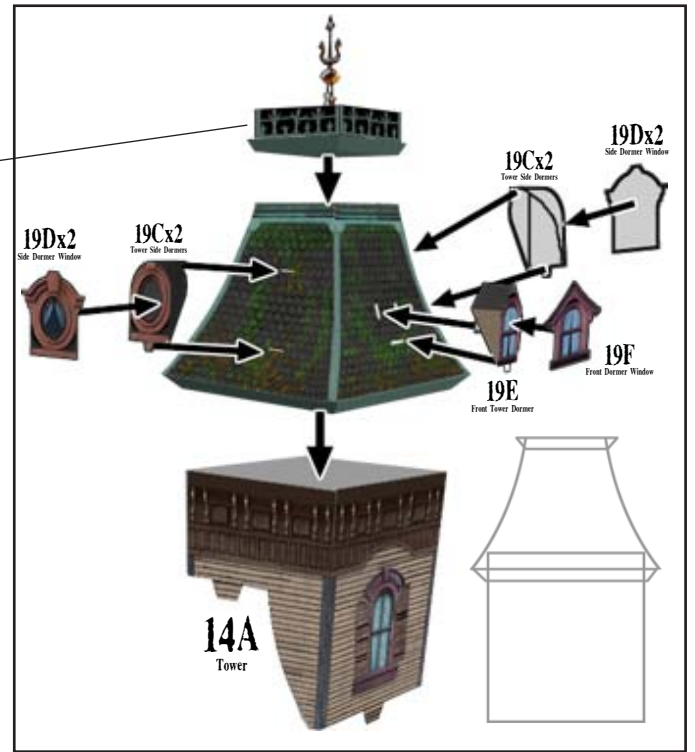

20Fx4
Dormers

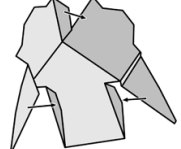

20Gx4
Dormers Windows

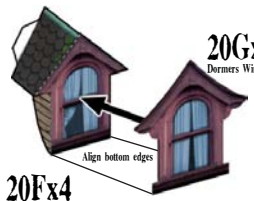

20Fx4
Dormers

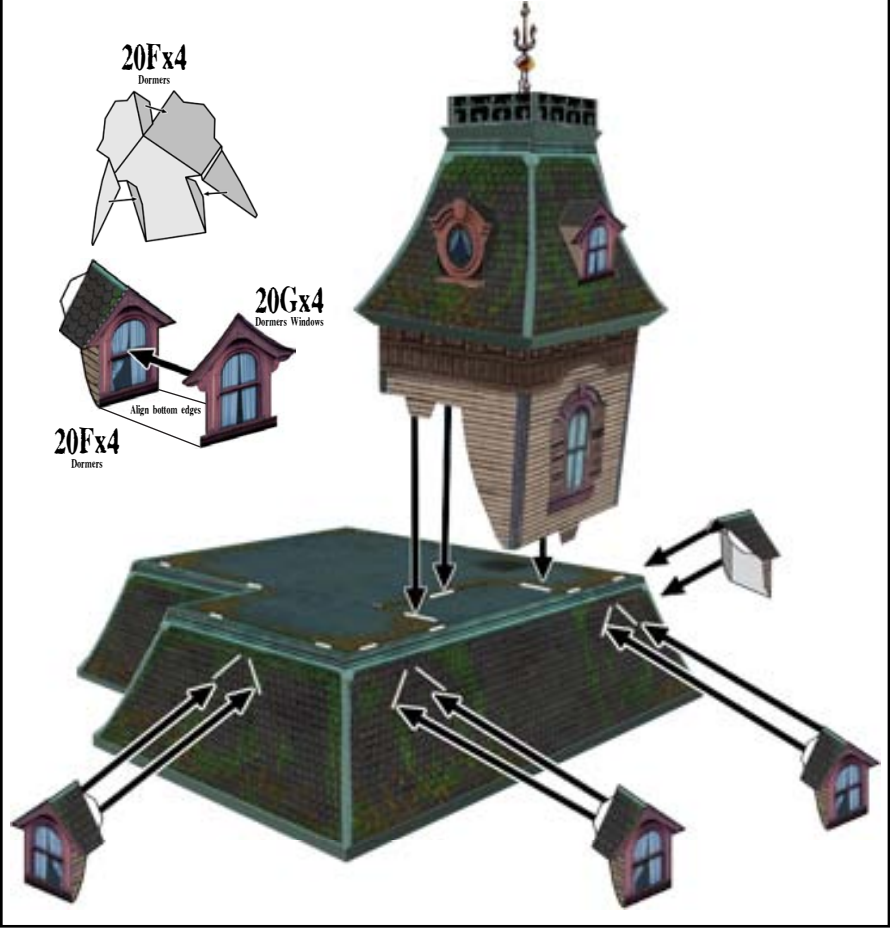

12D
Rear Crest

12B
Right Crest



12C
Left Crest





20B
Thin Chimney



20C
Fat Chimney



20A
Short Chimney

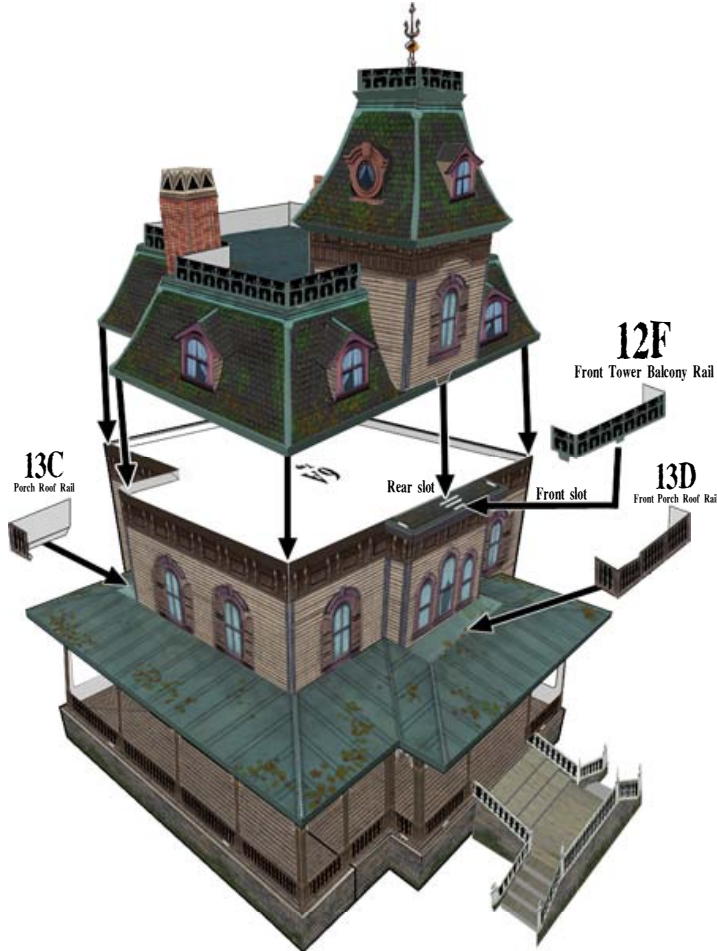
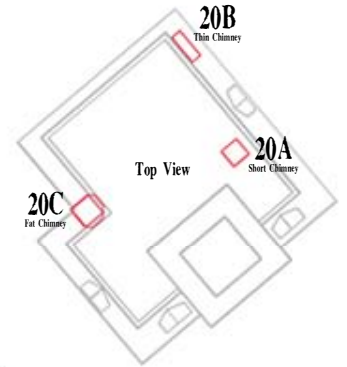
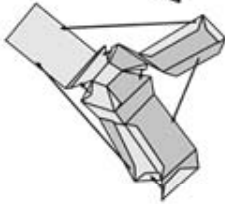



1Bx4
Shutters



1A
Front Wall

<slot

<slot

<slots

<slot

>slot>

>slot>

>slot>

>slots>

>slot>

Glue to 3A



1B x6
Shutters



2A
Left Wall



<slot
<slots
<slot
<slot

<slot
<slot

<slot
<slot





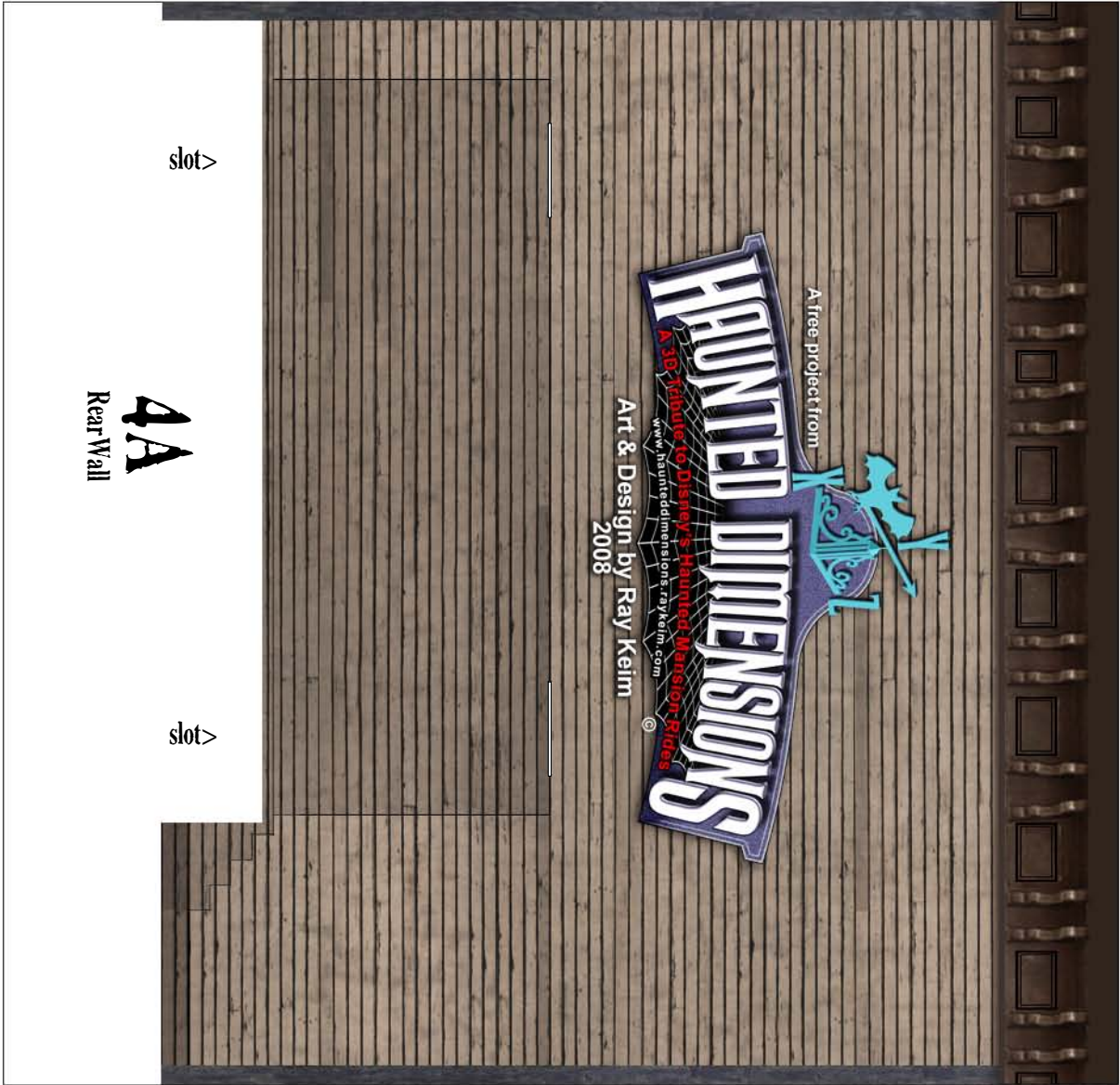

5A
Bottom

Do not repack or resell © Ray Keim 2008



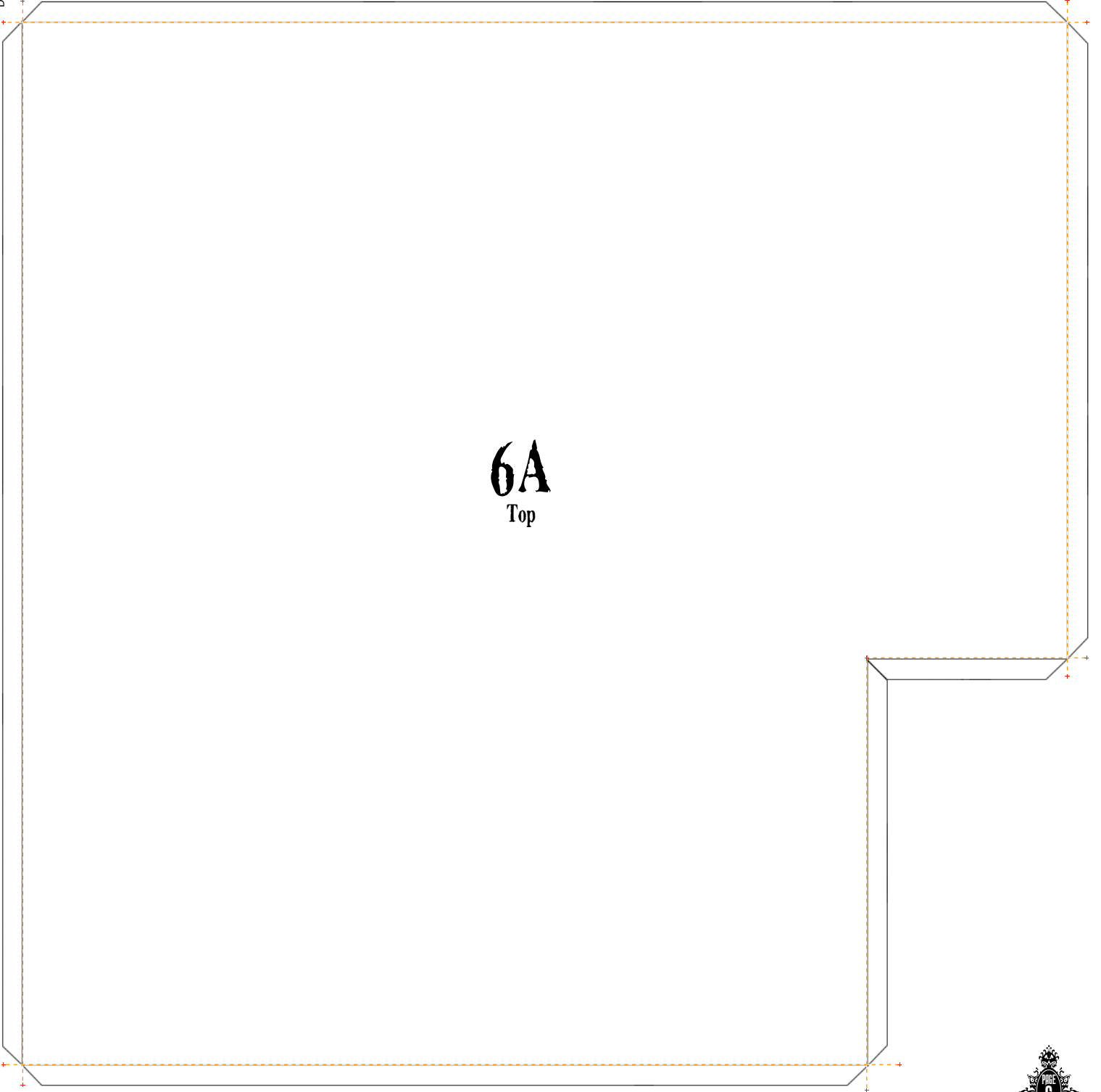

6A
Top



7A

Left Side Porch Floor



8A
Front Porch Floor

<slot

<slot

<slot

<slot





9B

Rear Shed



slot>

slot>

9A

Right Side Porch





10F
Front Tower Balcony

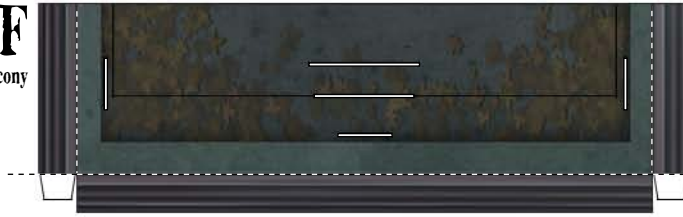

<slots

10A
Front Tower



<slot

10E
Right Side Steps Wall

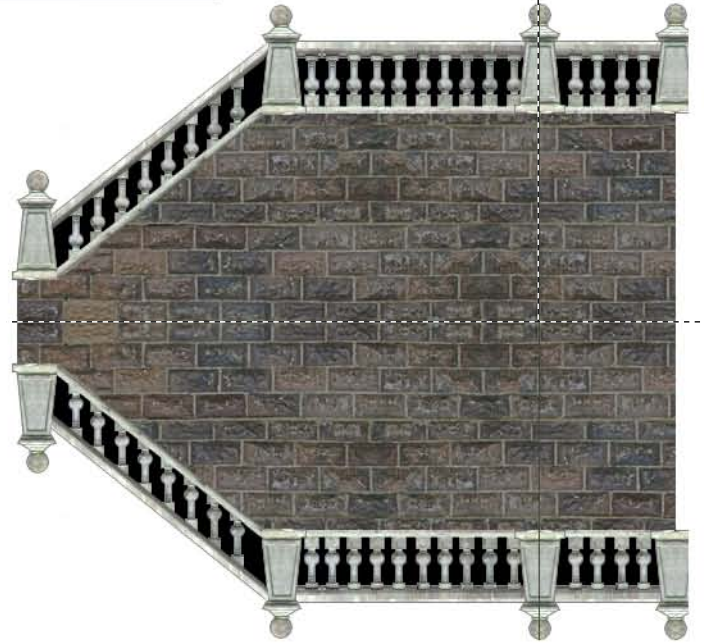

10C
Right Front Steps Wall

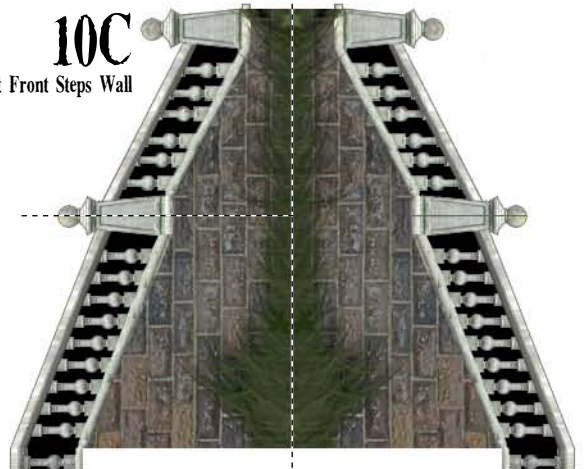

10D
Left Front Steps Wall

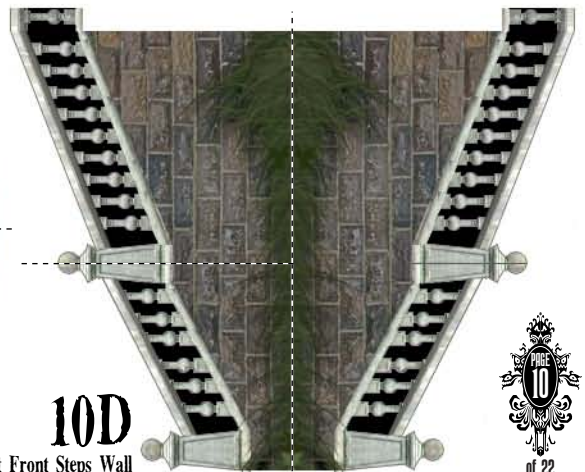

10B
Front Steps Wall

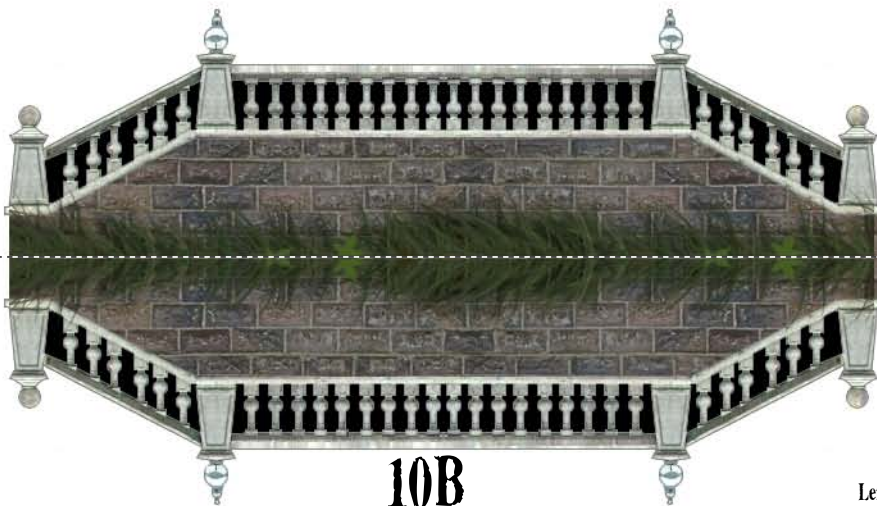



11C

Right Side Balcony



11D

Right Side Balcony Roof



11A

Front Porch Pillars

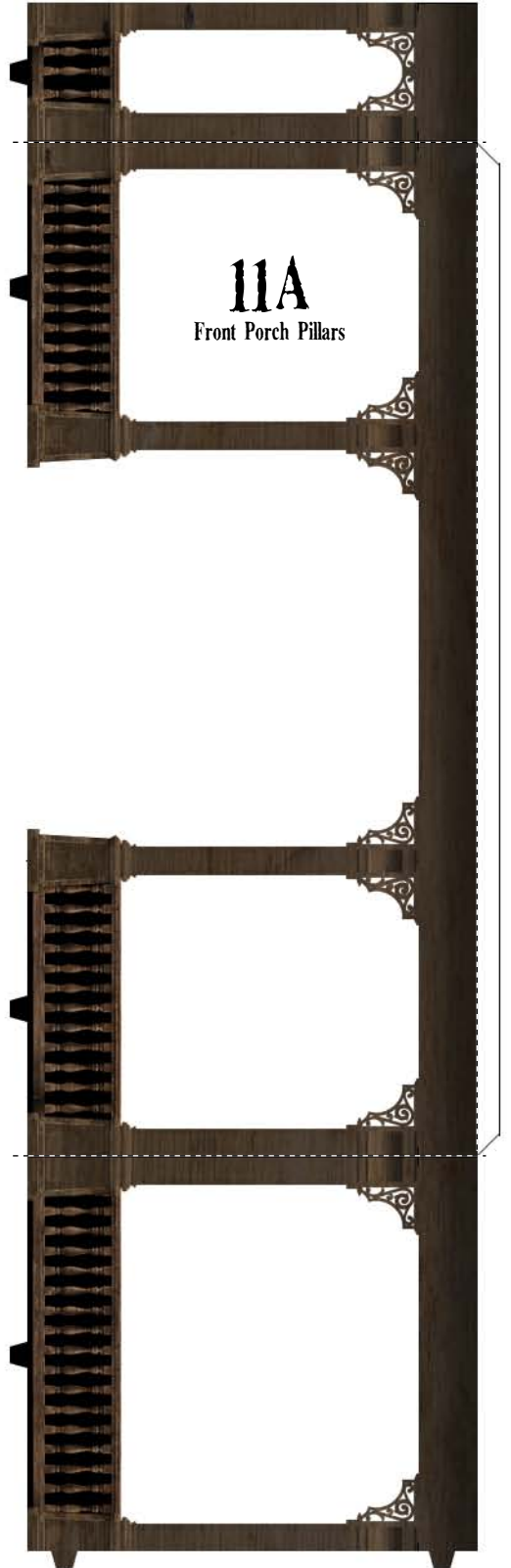

11B

Front Porch Pillars



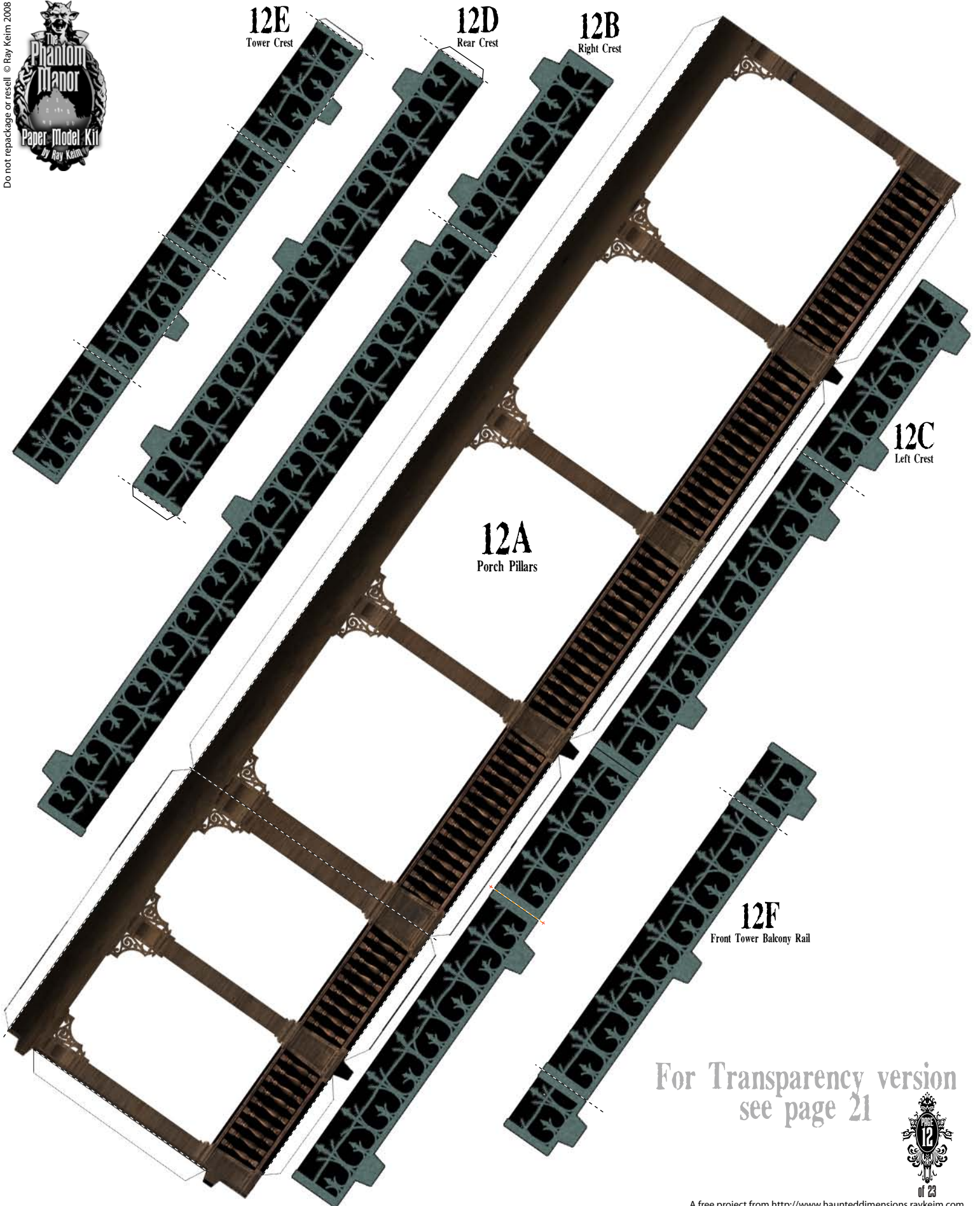

12E
Tower Crest

12D
Rear Crest

12B
Right Crest

12C
Left Crest

12A
Porch Pillars

12F
Front Tower Balcony Rail

For Transparency version
see page 21





13A
Front Porch Roof

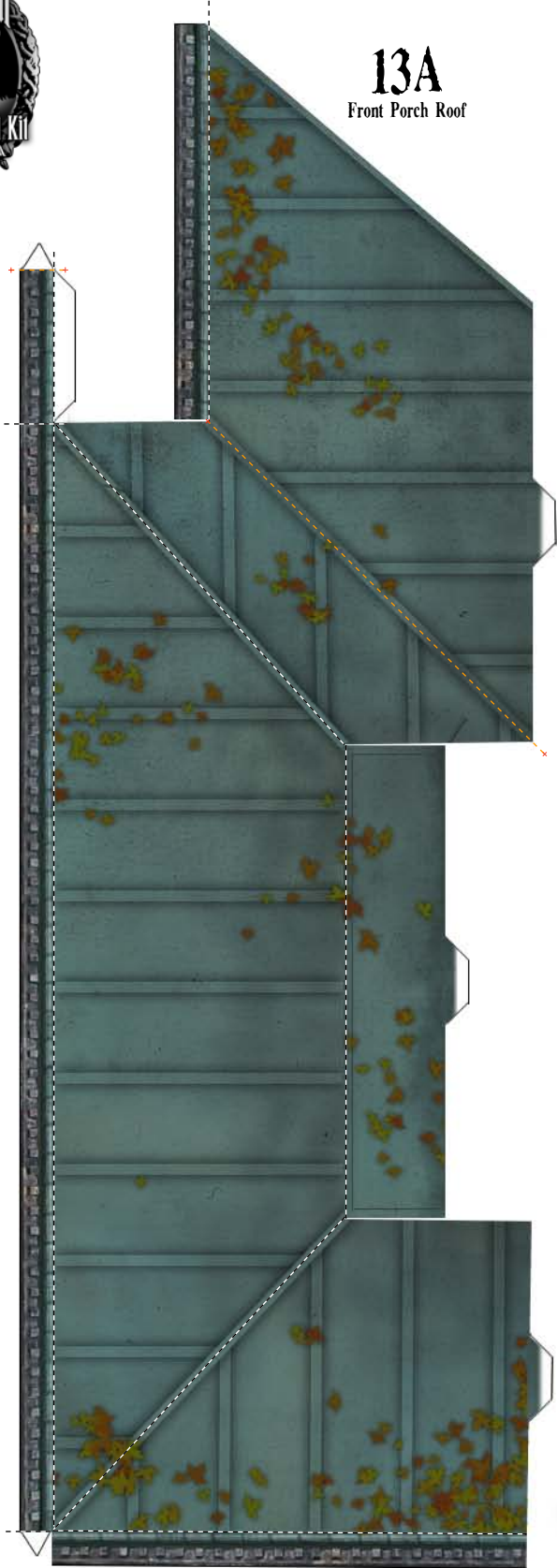

13C
Porch Roof Rail

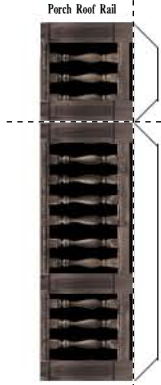

13B
Front Porch Roof

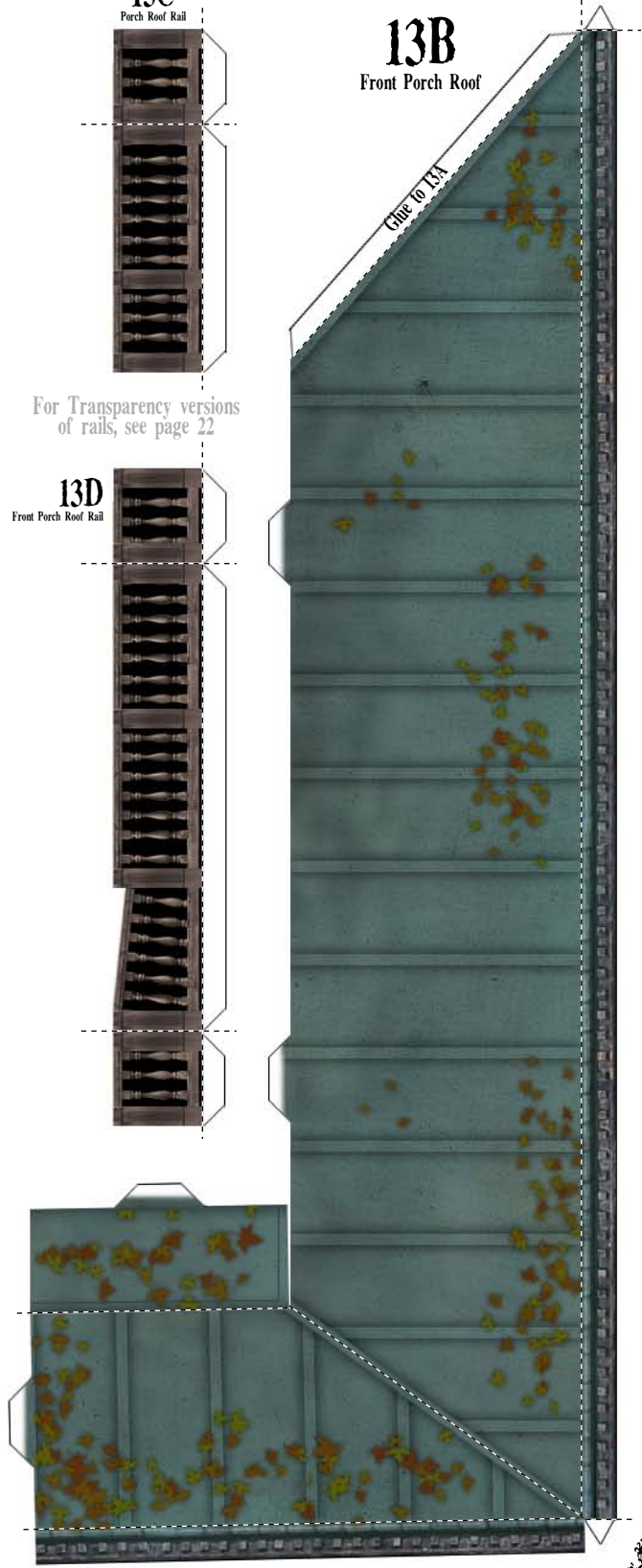

For Transparency versions
of rails, see page 22

13D
Front Porch Roof Rail



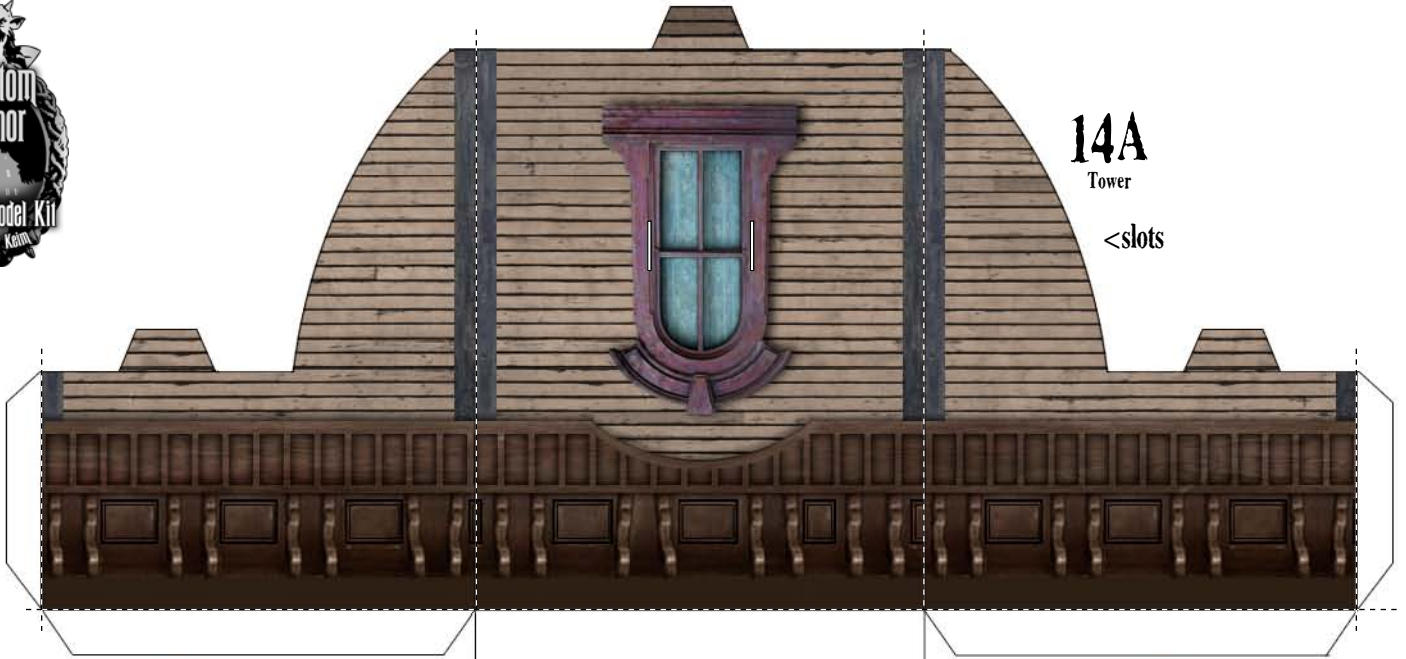

14A
Tower
<slots



14B
Right Side Porch Pillars
For Transparency versions
of pillars, see page 22



1B
Shutters

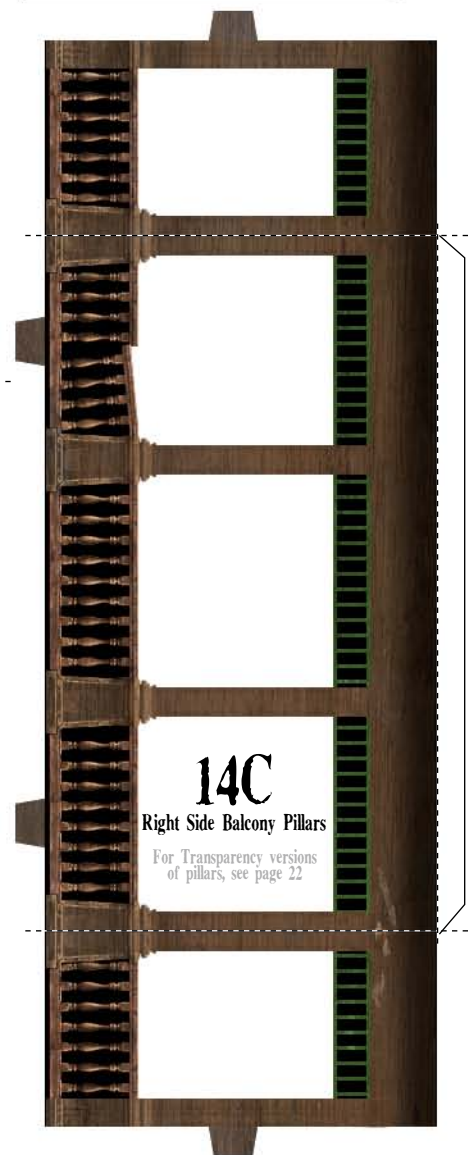

14C
Right Side Balcony Pillars
For Transparency versions
of pillars, see page 22

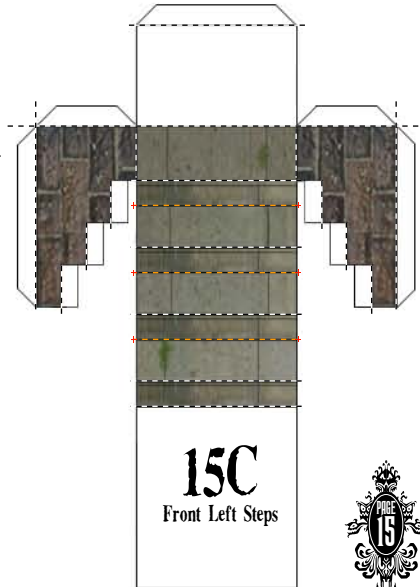
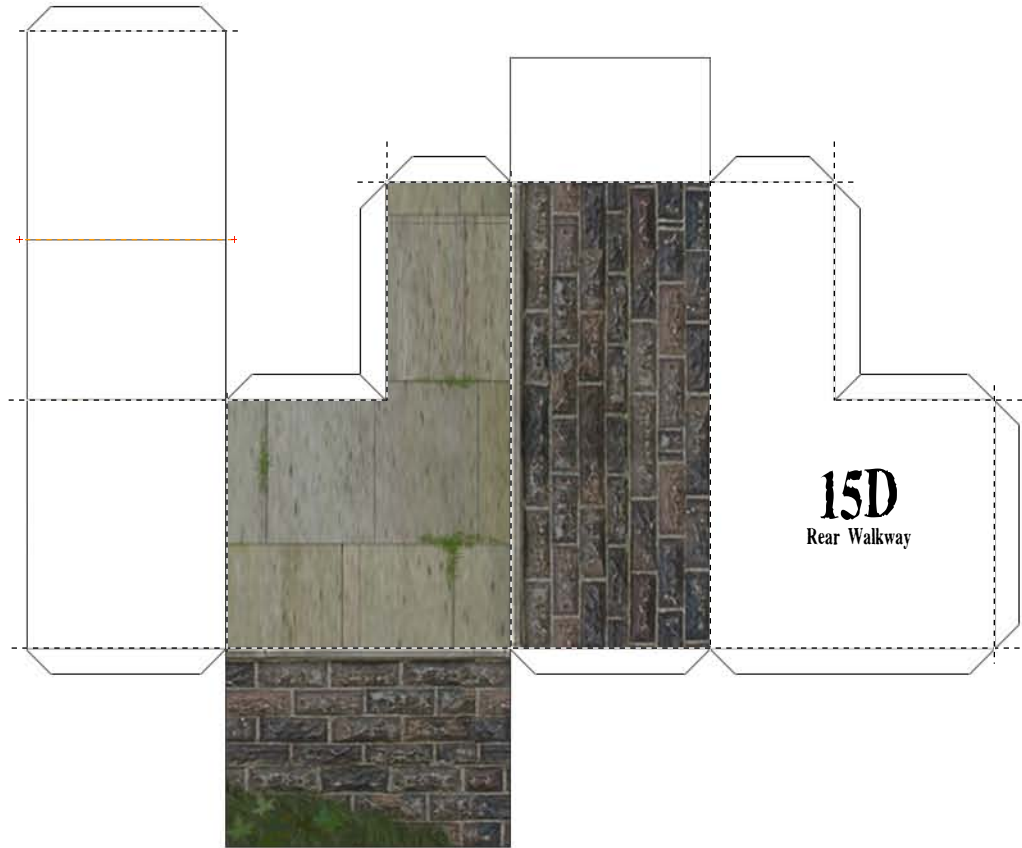
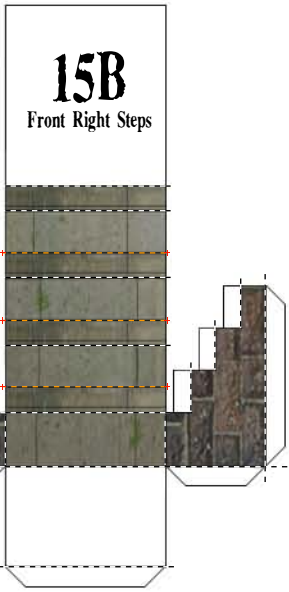

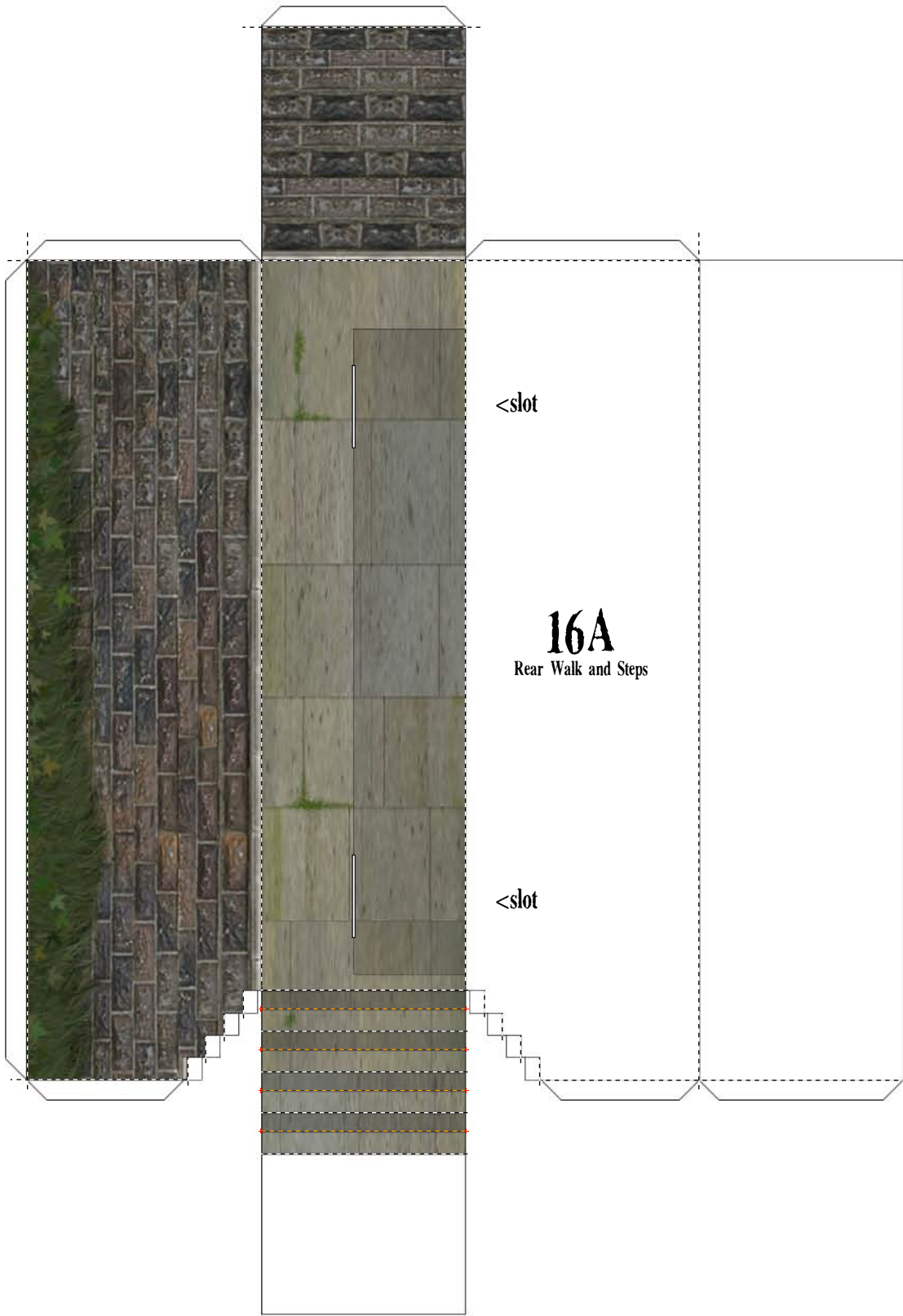

<slot

16A

Rear Walk and Steps

<slot



17A

Main Roof

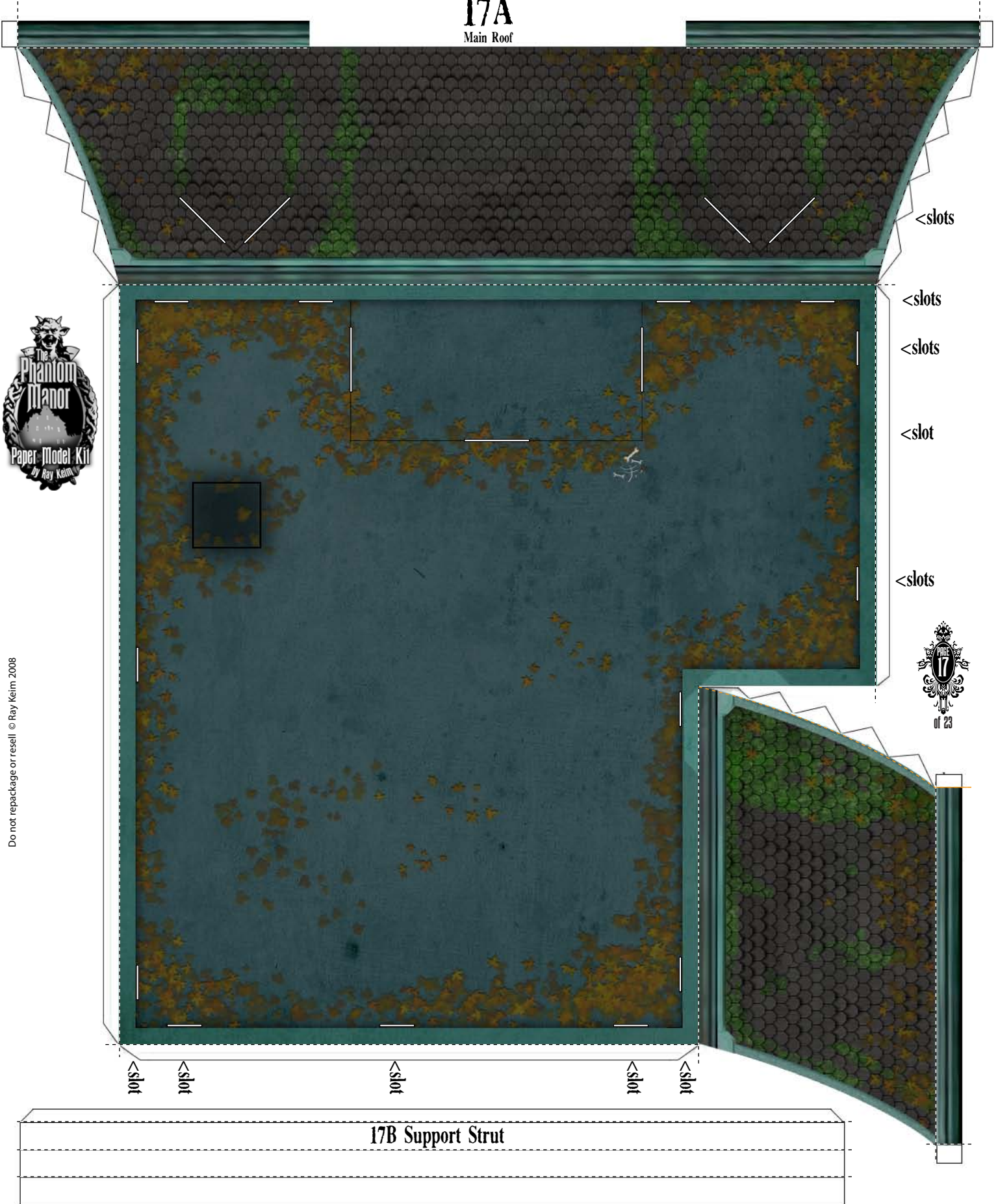

Do not repackage or resell © Ray Keim 2008



17B Support Strut



18A
Right Side Roof

<slot

<slot

<slot

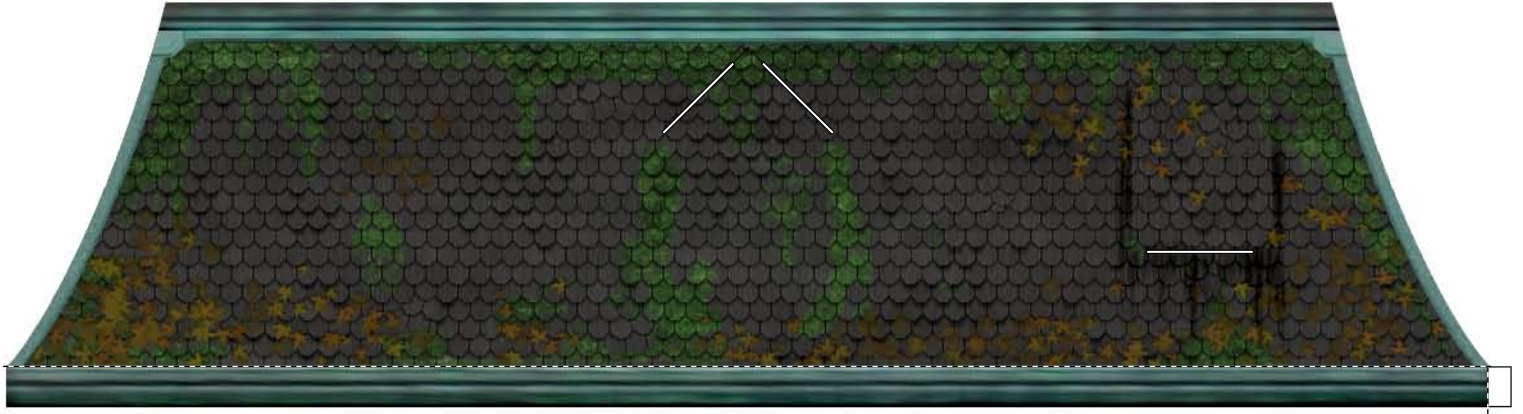

18D
Left Side Roof

<slot

<slot

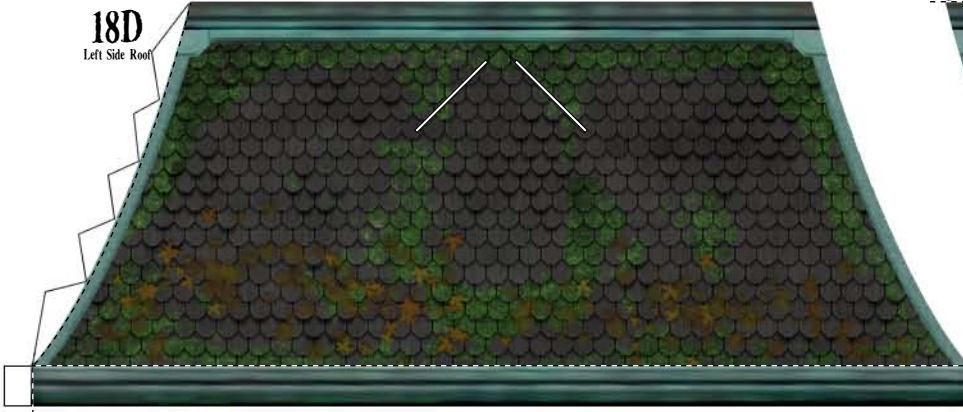

18C

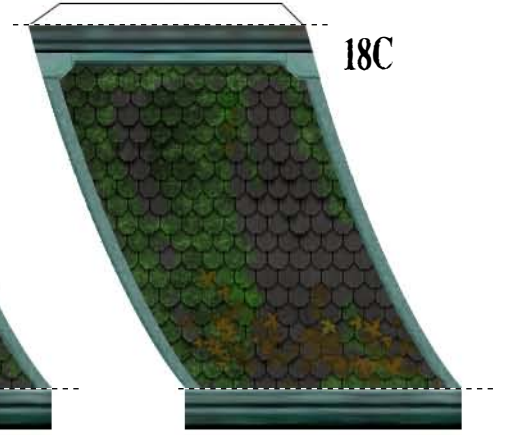

18B
Rear Roof

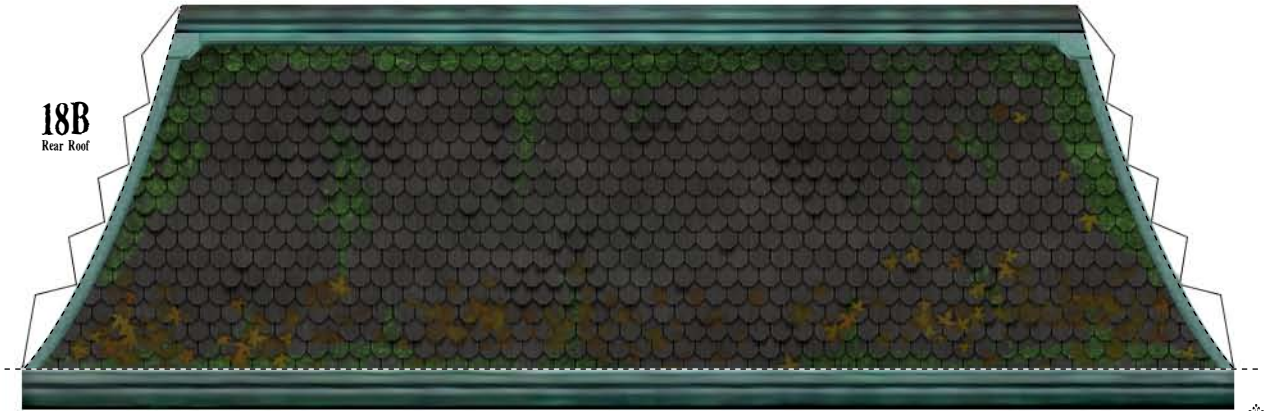

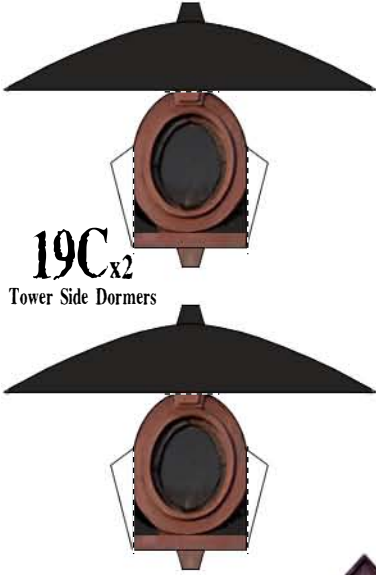

19C x2

Tower Side Dormers

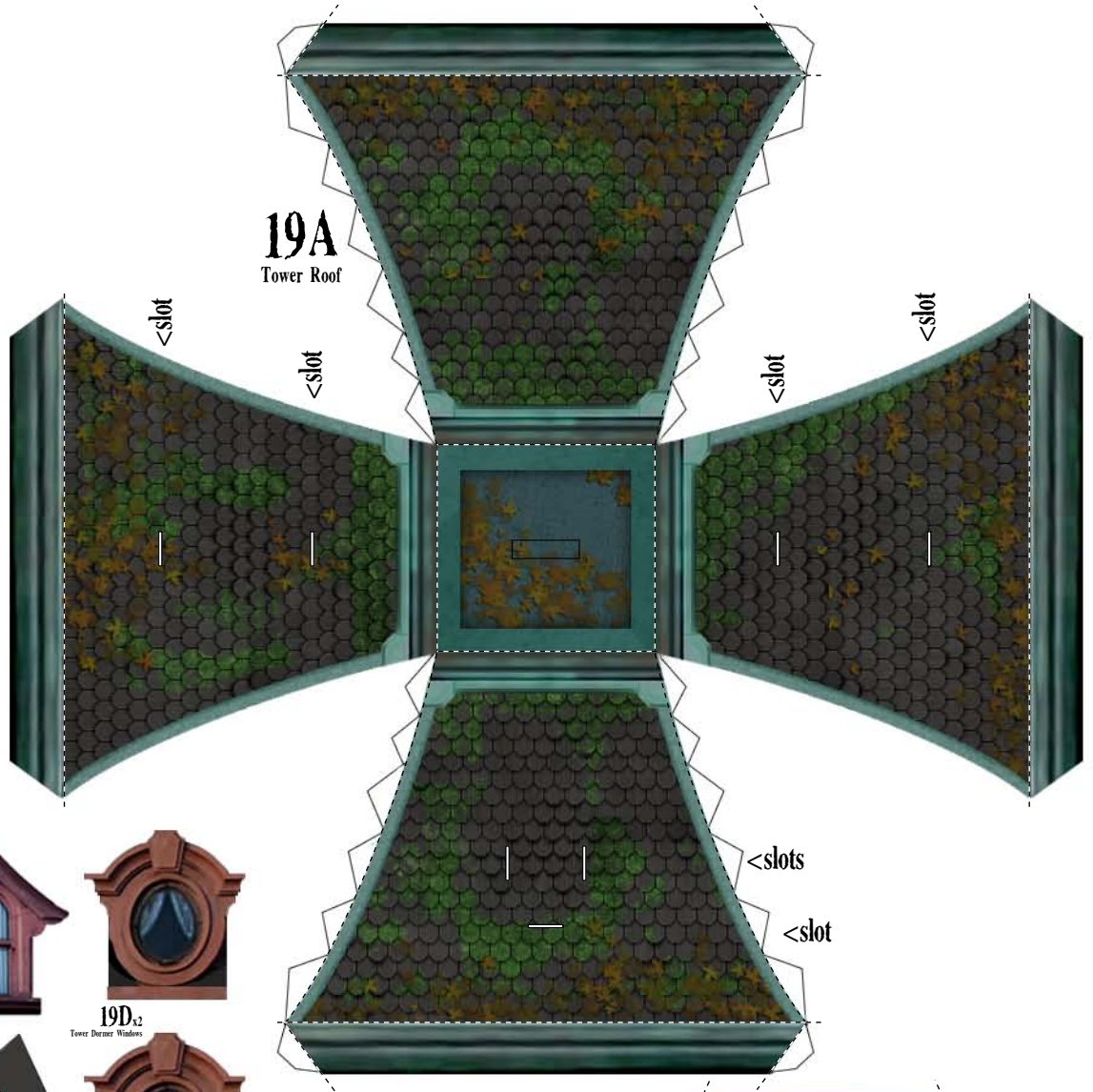

19A
Tower Roof

19B
Tower Roof Top

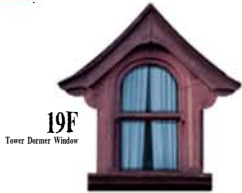

19F
Tower Dormer Window



19D x2
Tower Dormer Windows



19E
Front Tower Dormer



19D x2
Tower Dormer Windows

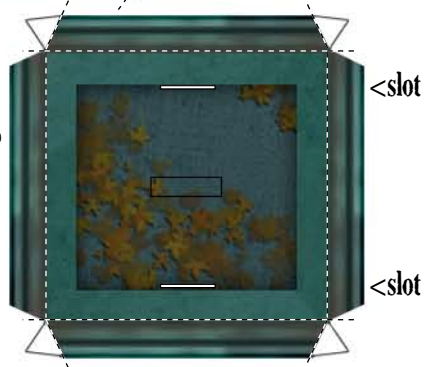

<slot

<slot

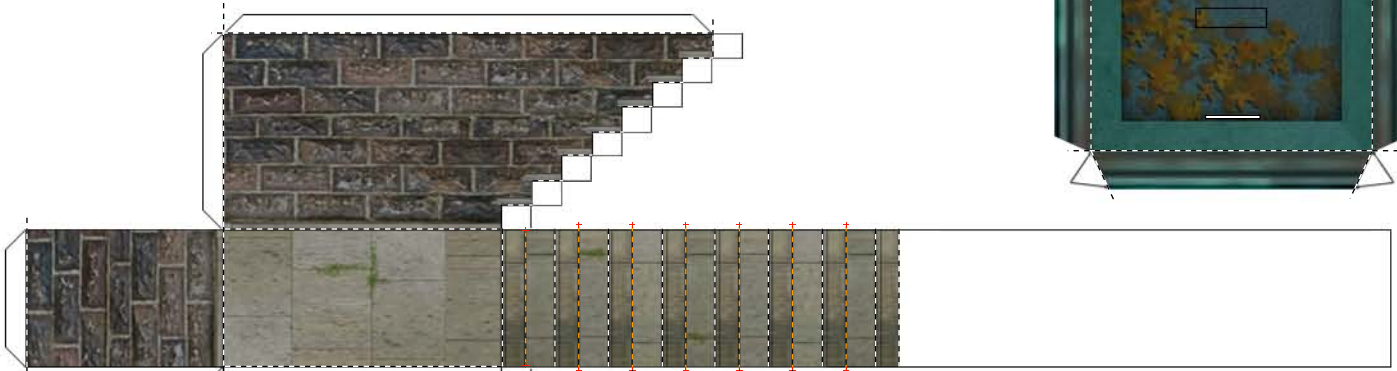

19H
Right Side Steps

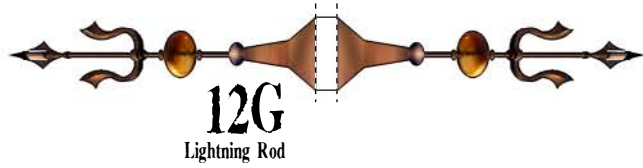

12G
Lightning Rod



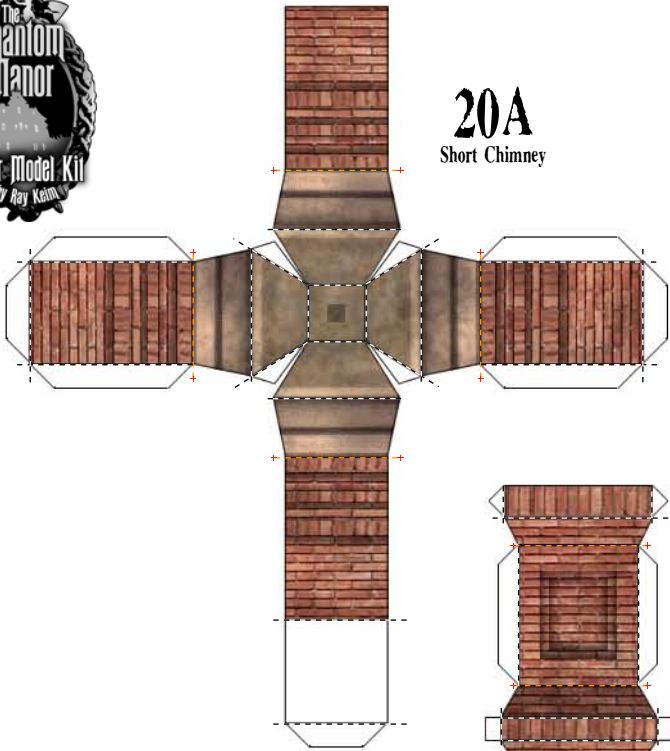

20A
Short Chimney

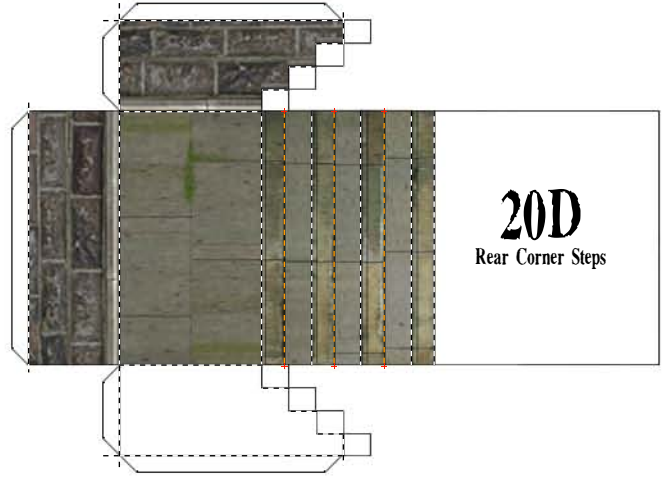

20D
Rear Corner Steps

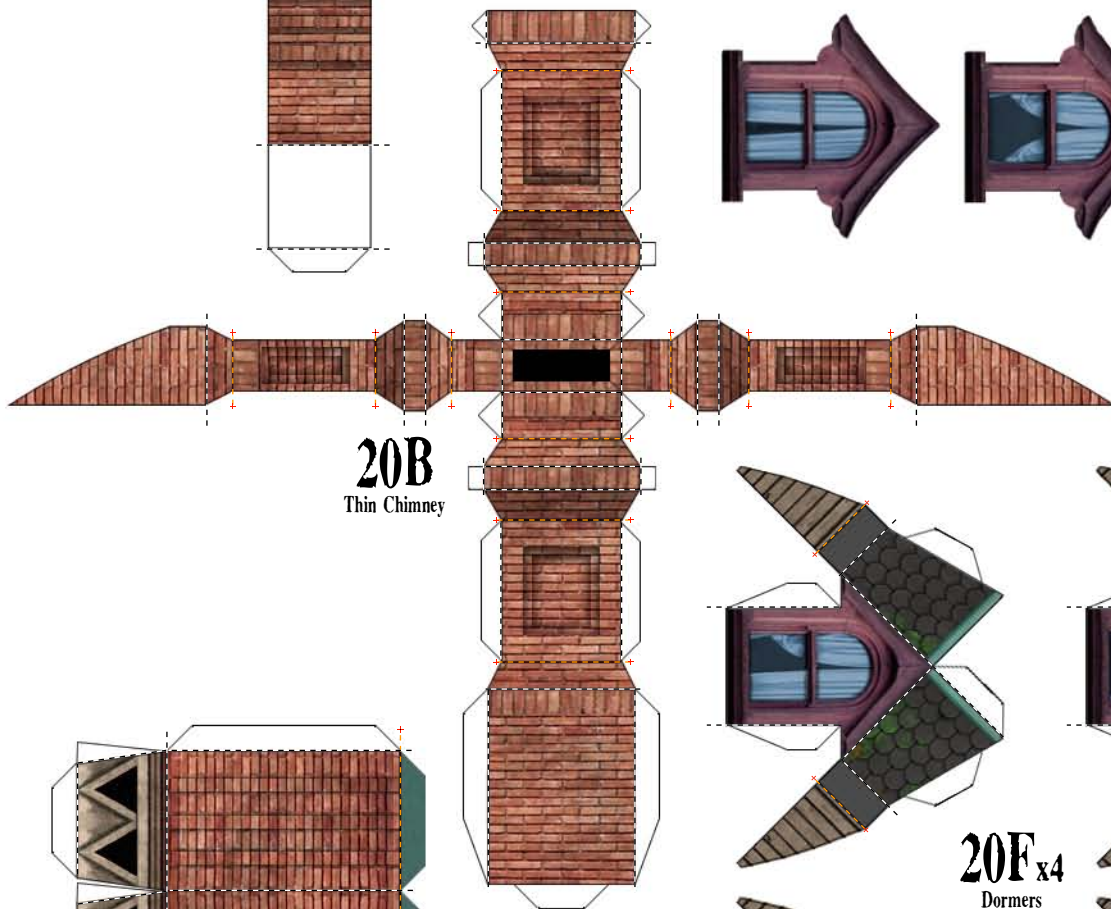

20B
Thin Chimney

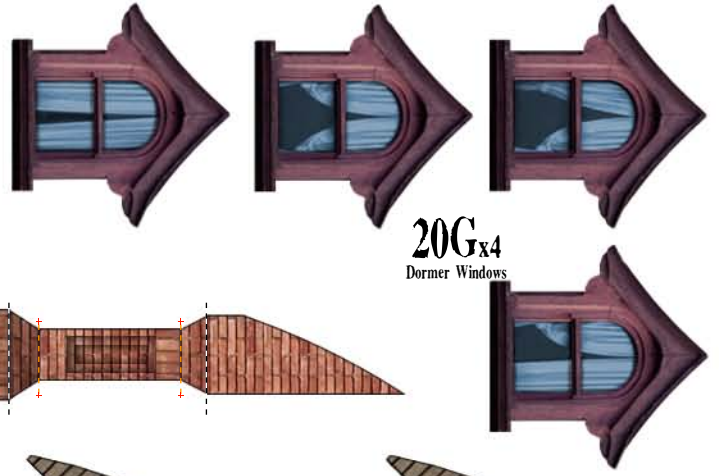

20Gx4
Dormer Windows

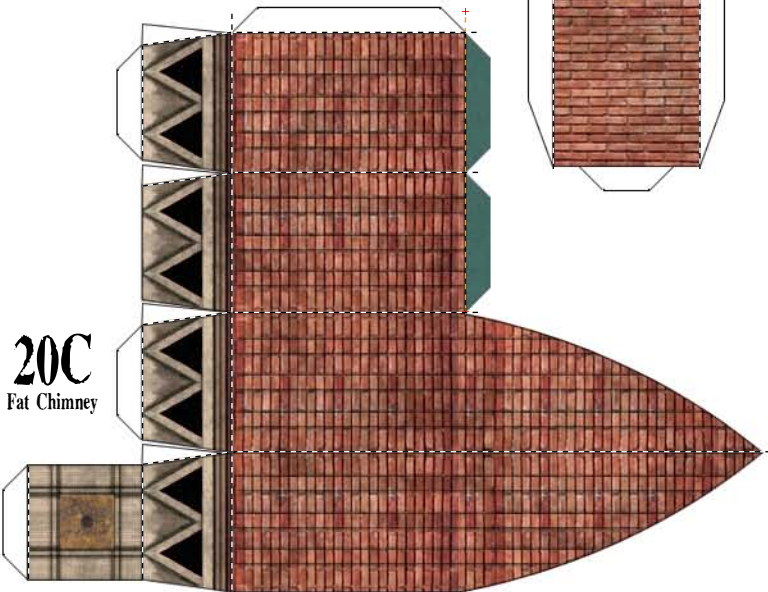

20C
Fat Chimney

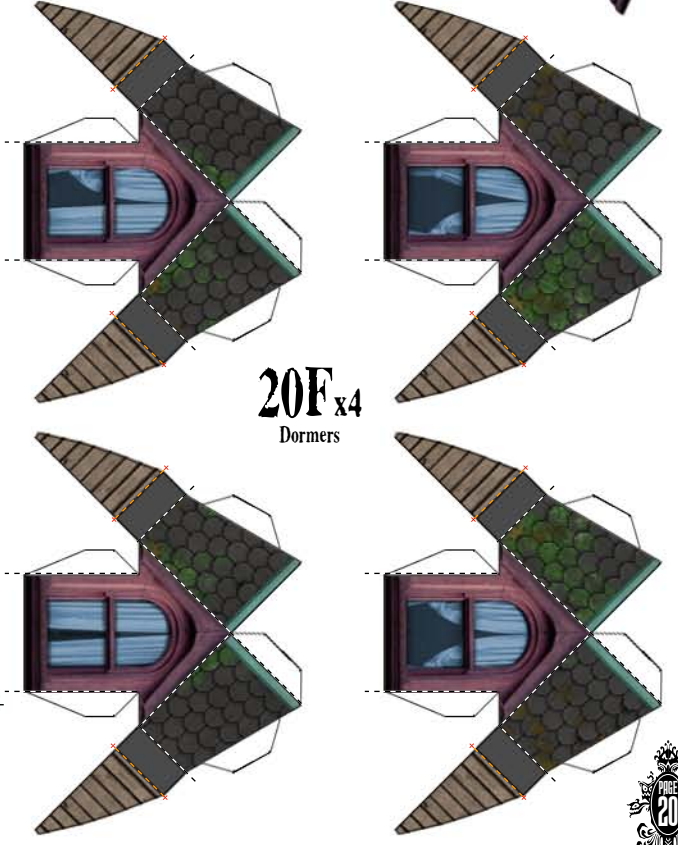

20F x4
Dormers





12E
Tower Crest

12D
Rear Crest

12B
Right Crest

12C
Left Crest

12A
Porch Pillars

12G
Lightning Rod

12F
Front Tower Balcony Rail

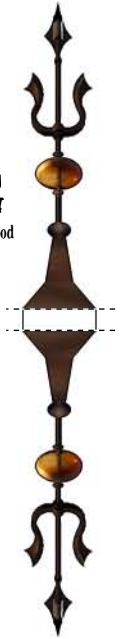
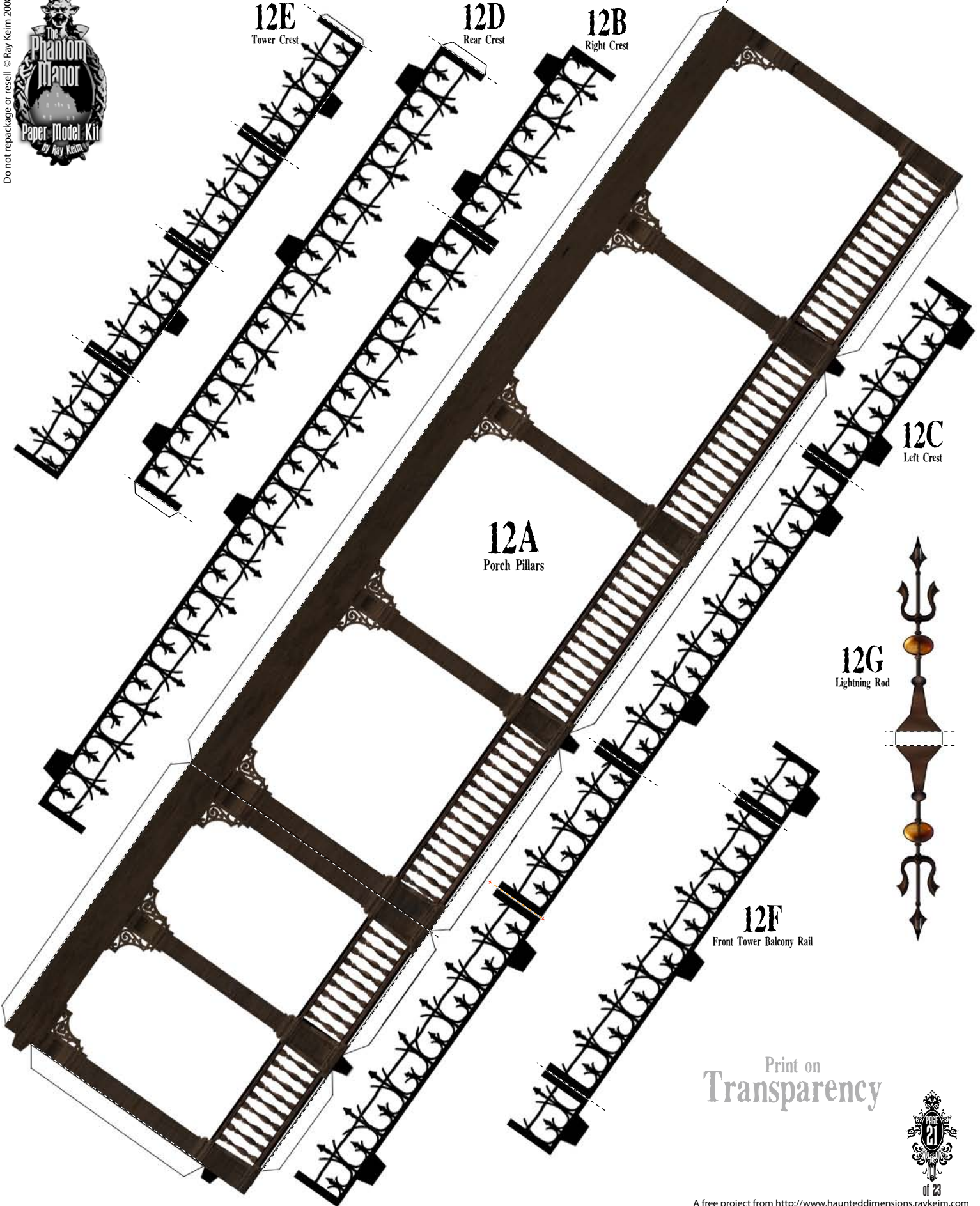

Print on
Transparency





Print on
Transparency

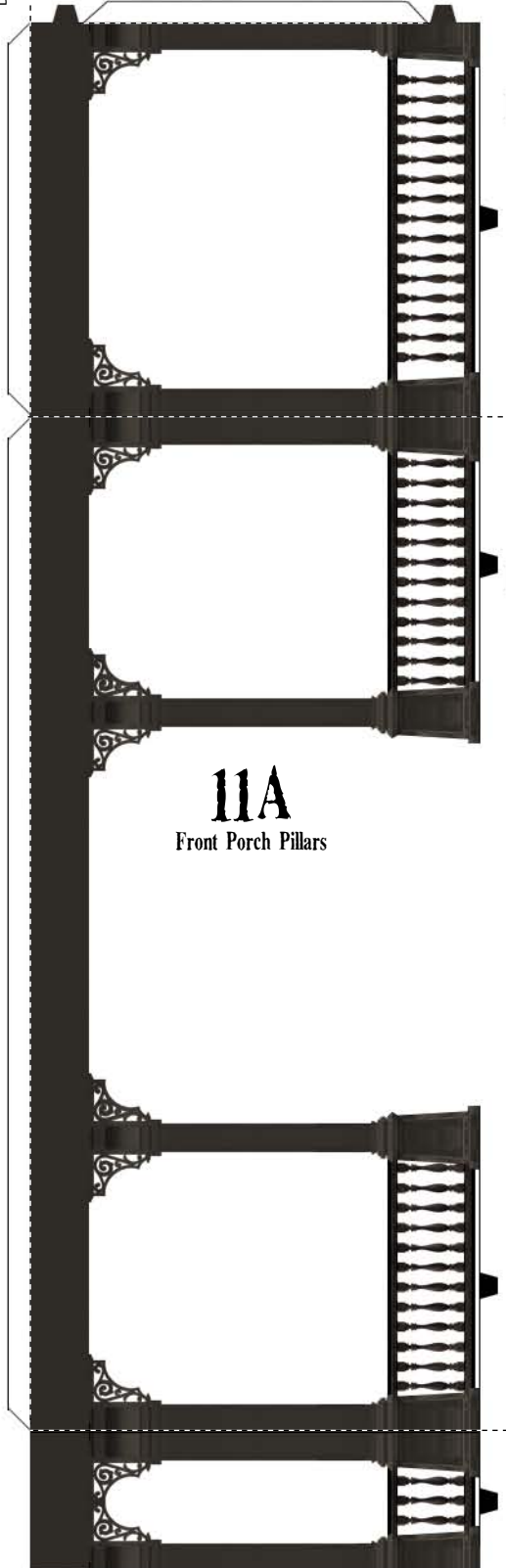

11A
Front Porch Pillars

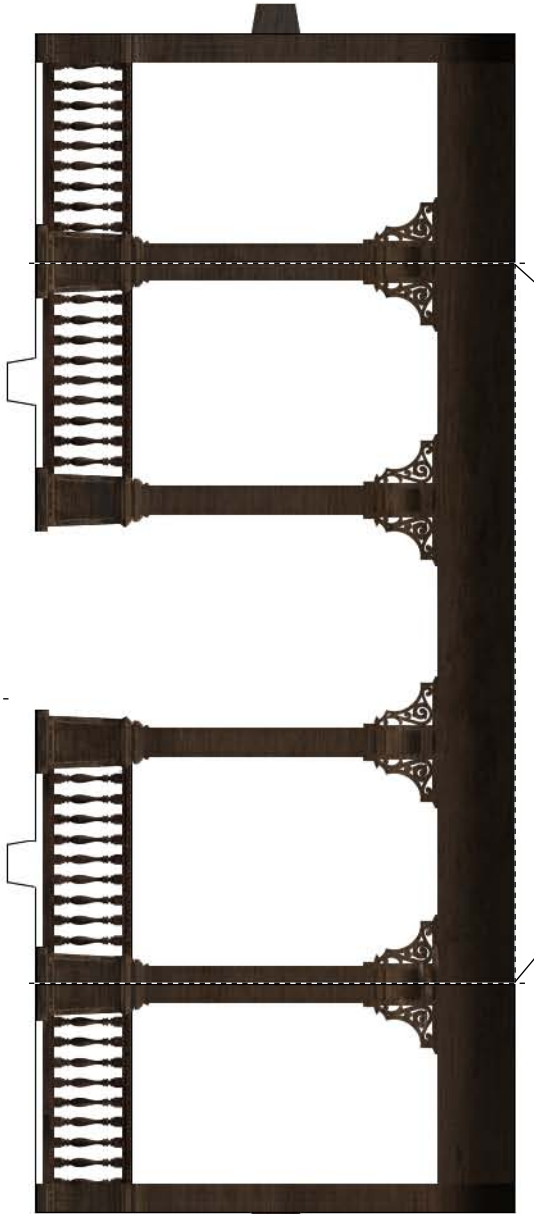

14B
Right Side Porch Pillars

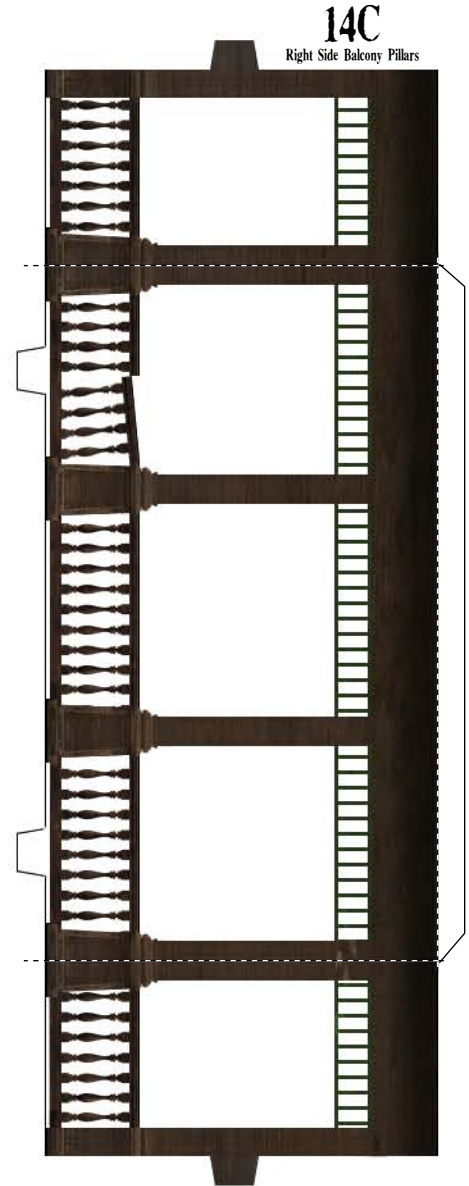

14C
Right Side Balcony Pillars

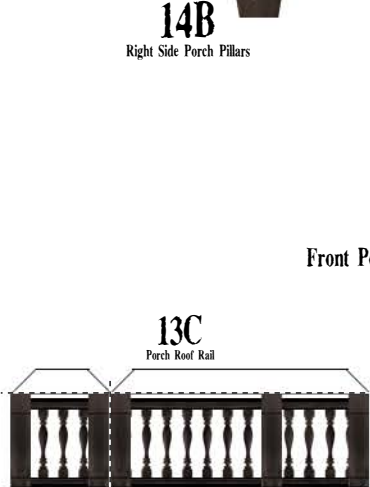

13C
Porch Roof Rail

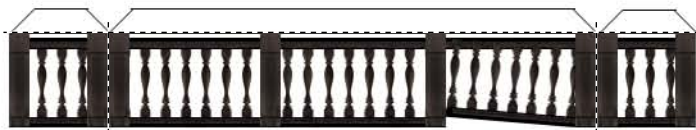

13D
Front Porch Roof Rail

11B
Front Porch Pillars

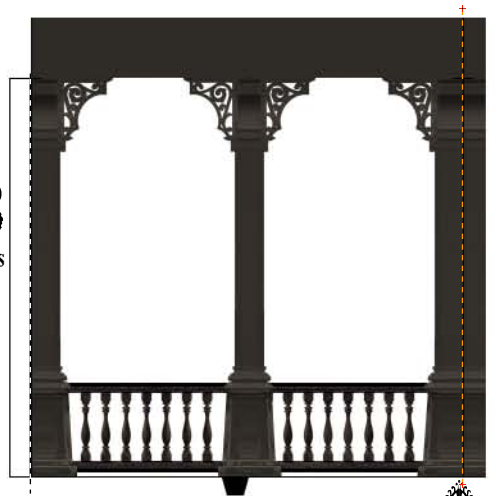



23A_{x12}

Optional Window Inserts

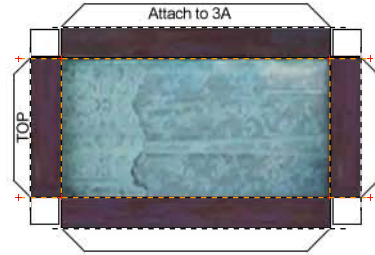
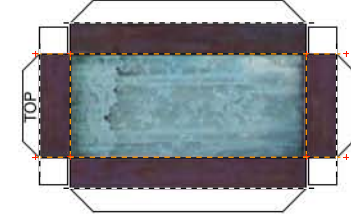
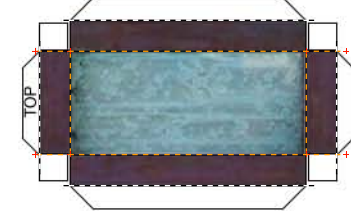
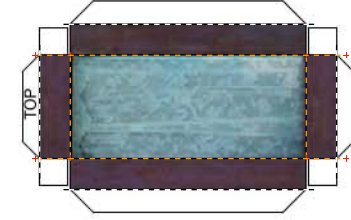
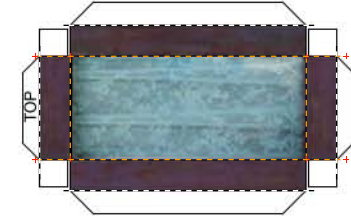
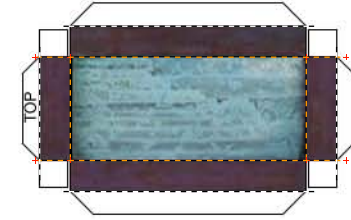
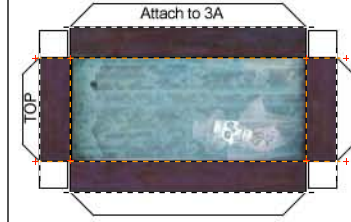
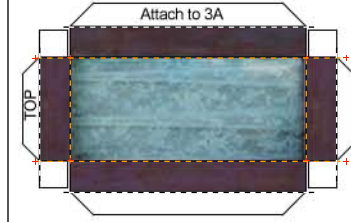
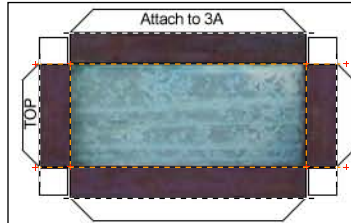
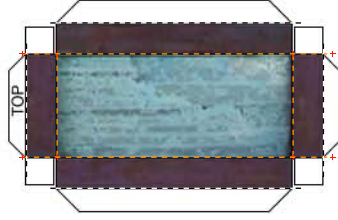
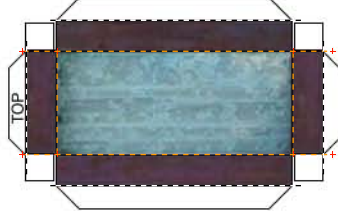
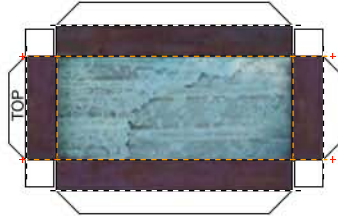

23B

Optional Window Insert
for wall 3A

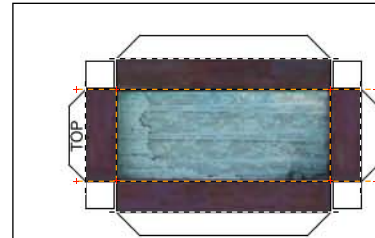

23D

Optional Window Insert
Tower



23C

Optional Window Insert
Tower

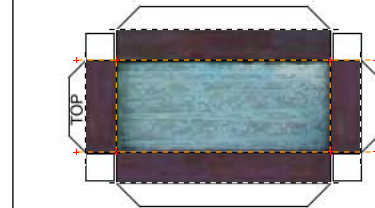

23D

Optional Window Insert
Tower

