

# Italian Villa

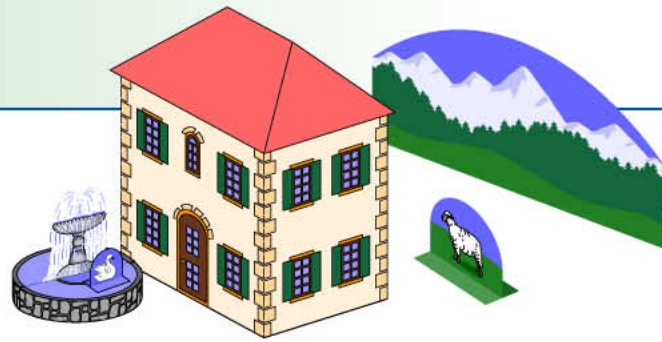

1



Printing on plain paper works, but for best results, print on Smooth Card Stock (65# Cover) or other heavy weight (thick) paper.

Most Ink Jet printers can handle thick paper, but you may want to check your Printer's manual to make sure it does.

Make sure the Page Settings on your printer are set to Landscape before printing.

2



Cut out along the dashed lines using a pair of scissors.

Parental guidance is advised when small children are using scissors.

3



Fold along the dotted lines. Some cut-outs fold in-ward, others fold outward. Use the illustrated guides below to see which direction to fold cut-outs.

4

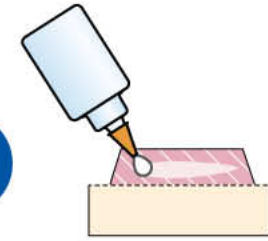

Apply **Glue** to the pink-stripe tabs and to the unprinted side of the cow, sheep and swan cut-outs. Use a glue stick or craft paste. (Wet glue tends to wrinkle the paper.)

For quicker assembly, tape can be used in place of glue.

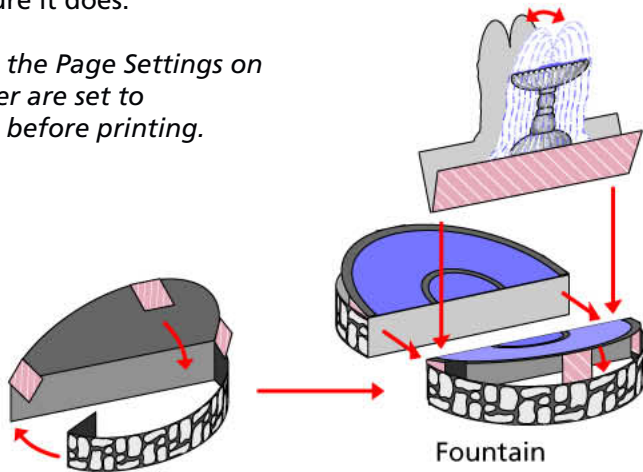

Fountain

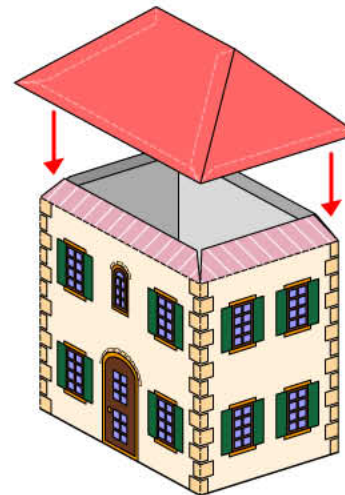

House

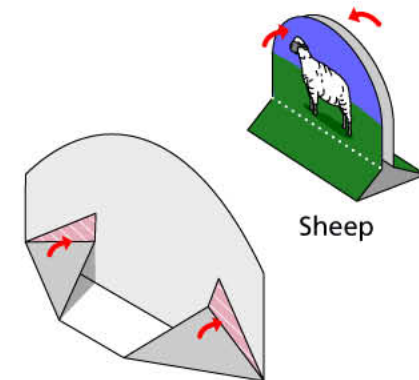

Landscape (Backside)

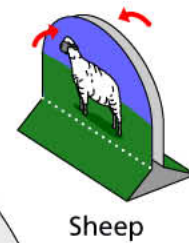

Sheep

# Italian Villa

PRINT-n-PLAY TOYS

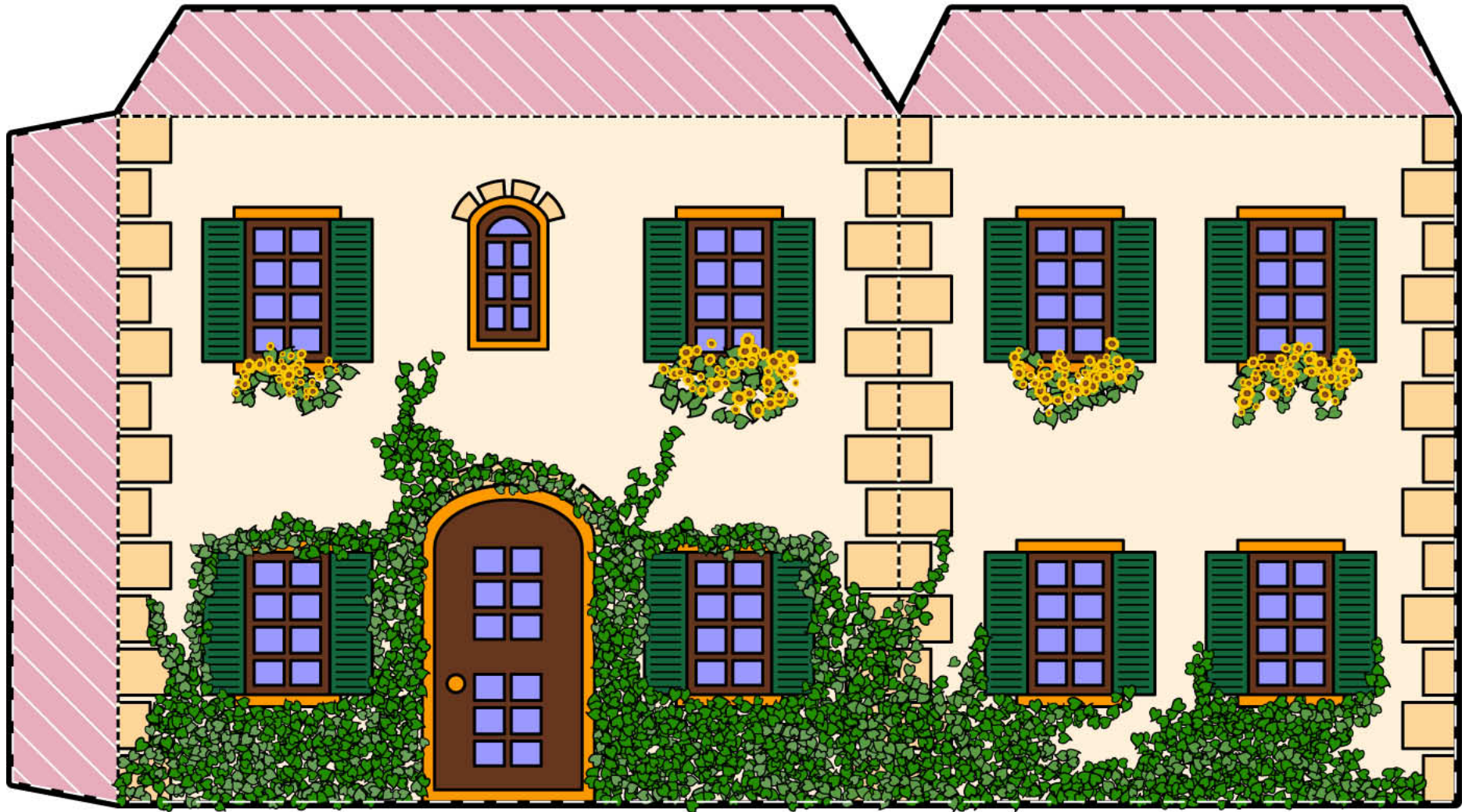

If you appreciate these toys, We would appreciate a **donation** of \$5.00.

Copyright© 2003, McGuire Design

# Italian Villa

PRINT-n-PLAY TOYS

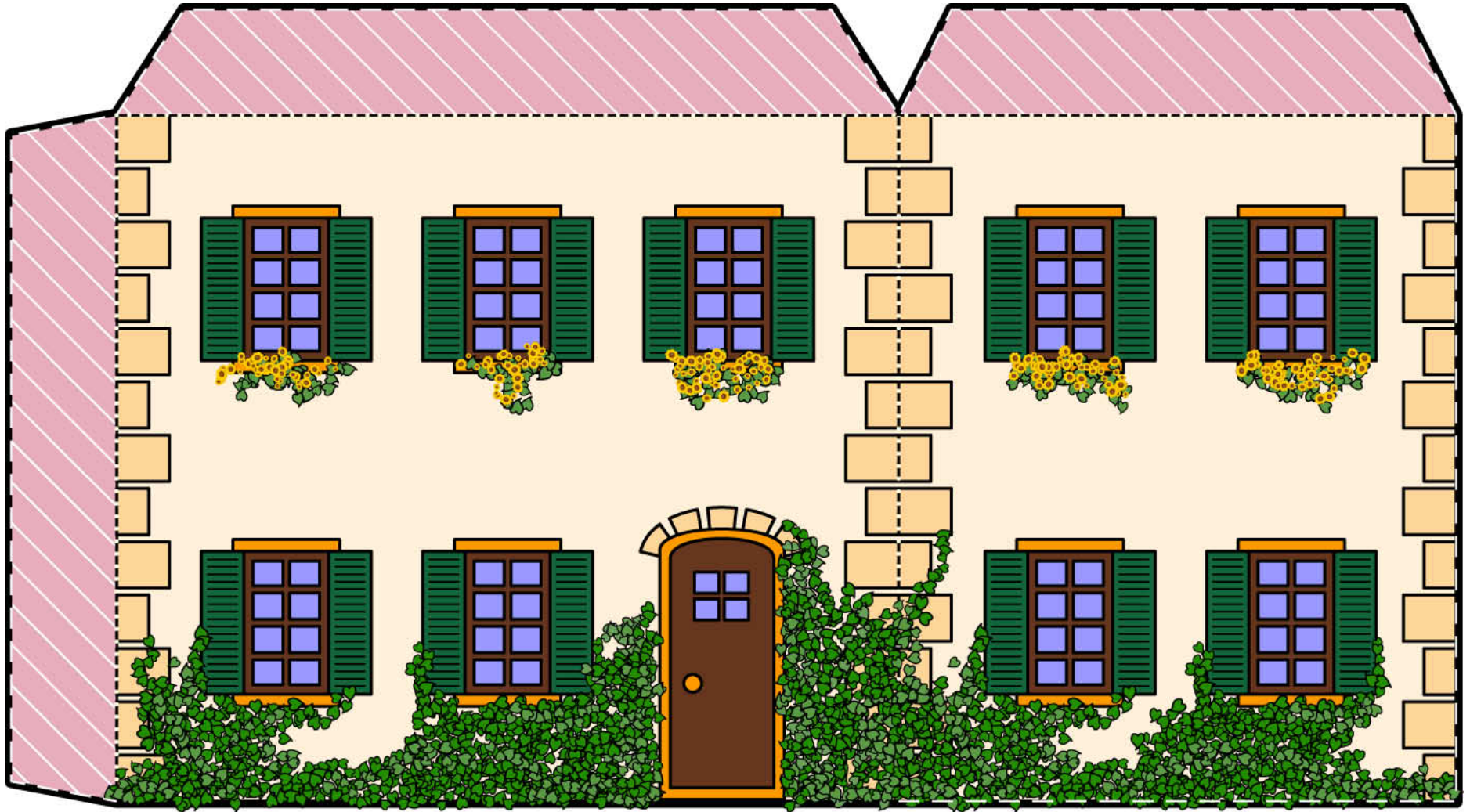

If you appreciate these toys, We would appreciate a **donation** of \$5.00.

Copyright© 2003, McGuire Design

# Italian Villa

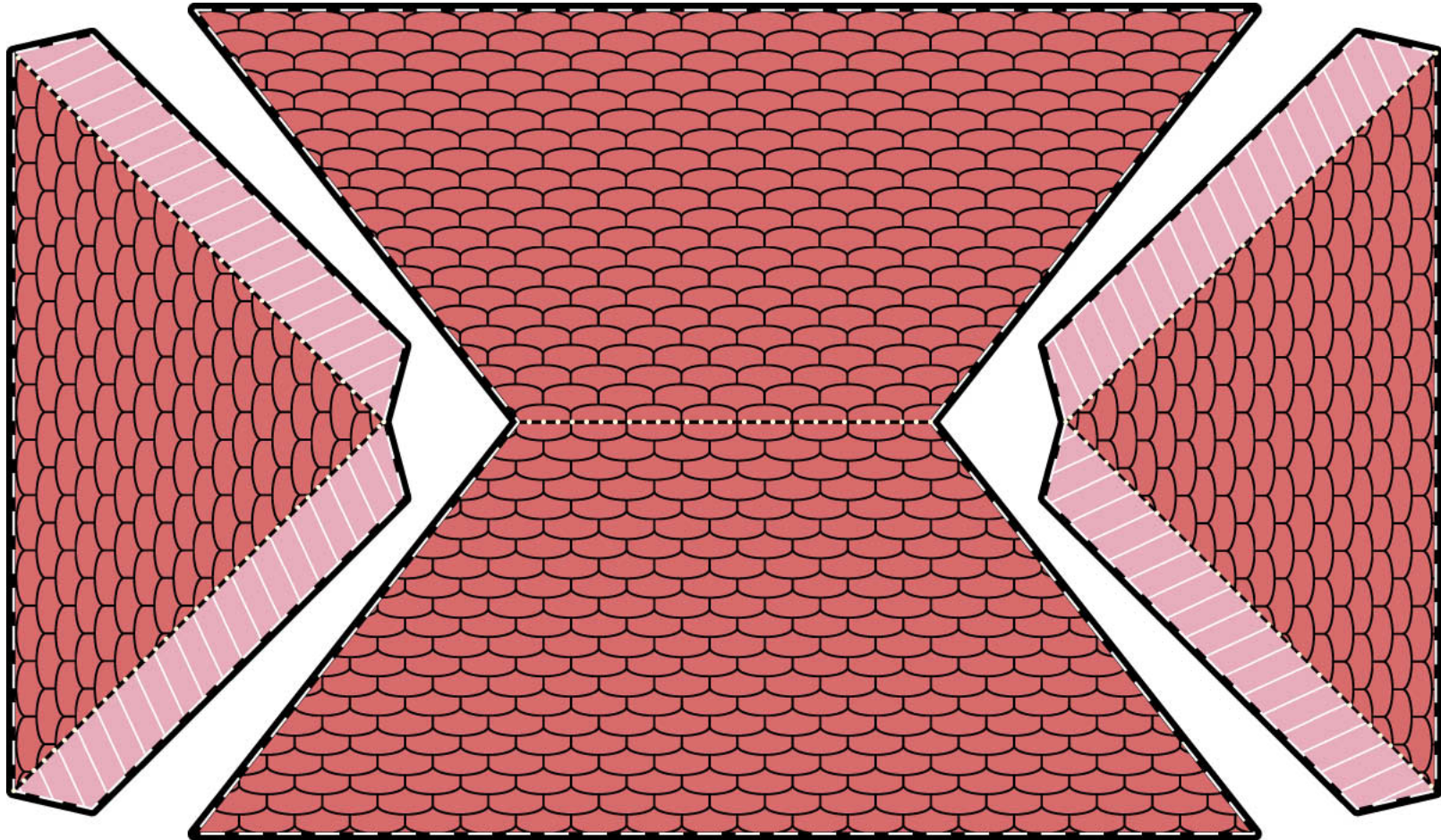

# Italian Villa

PRINT-n-PLAY TOYS

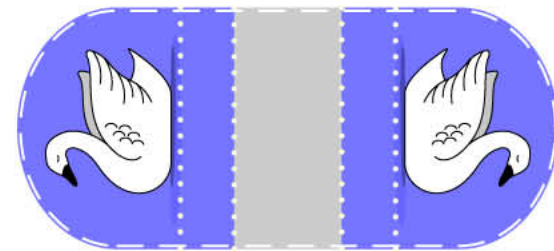
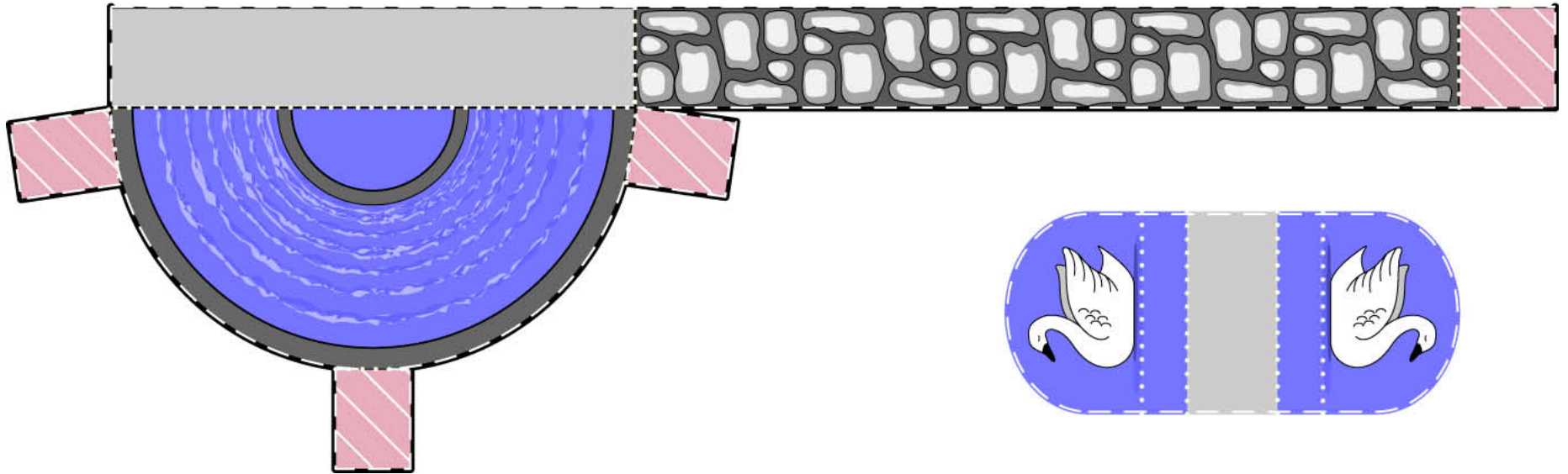
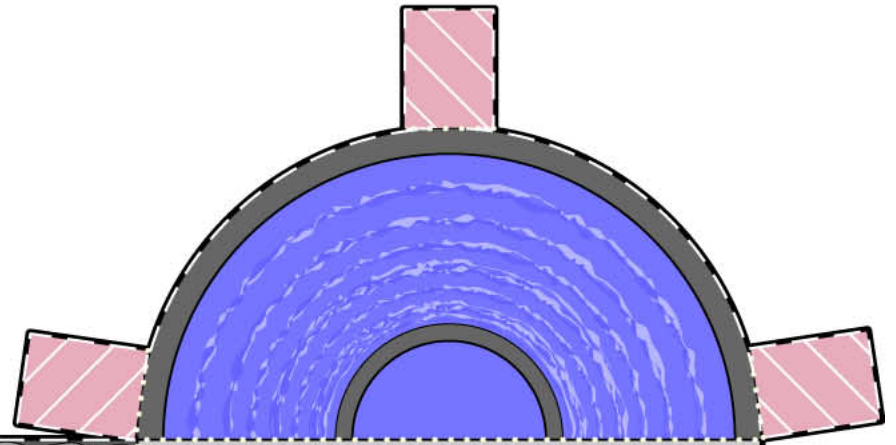
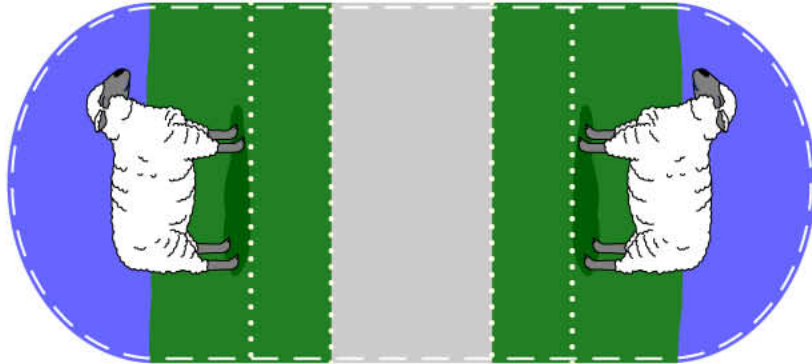

# Italian Villa

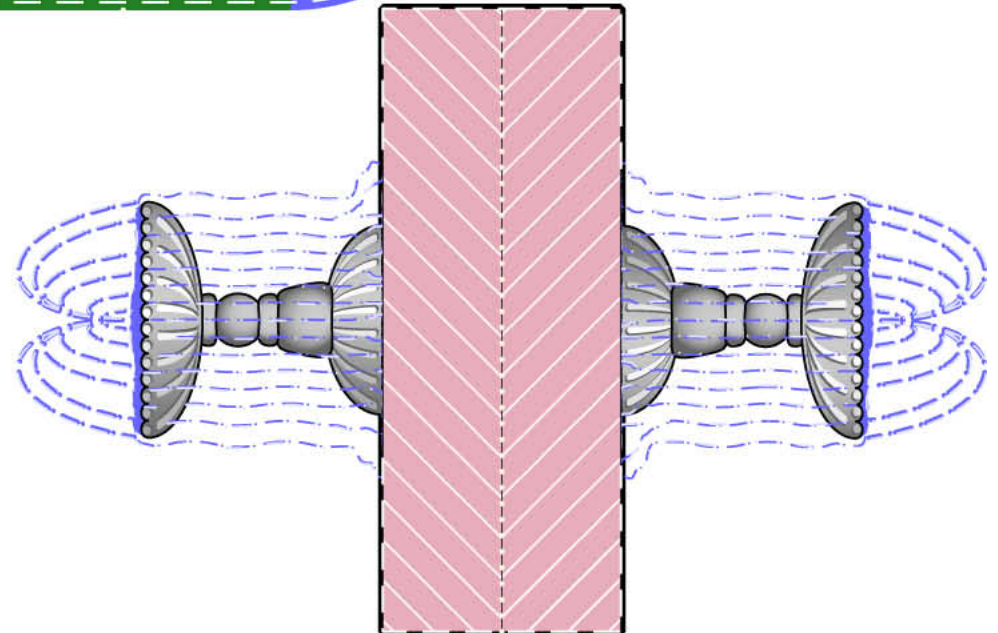
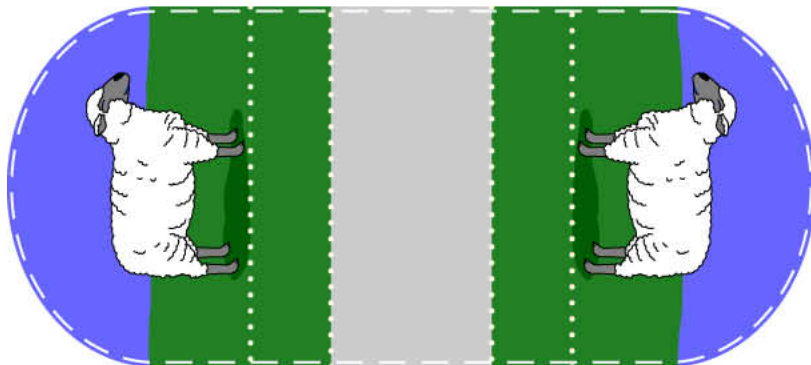
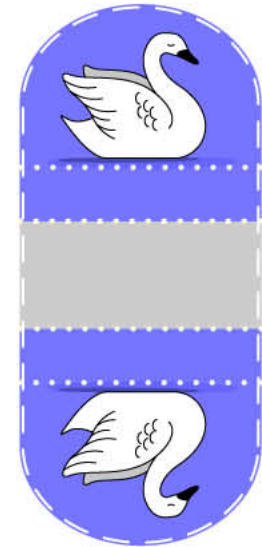
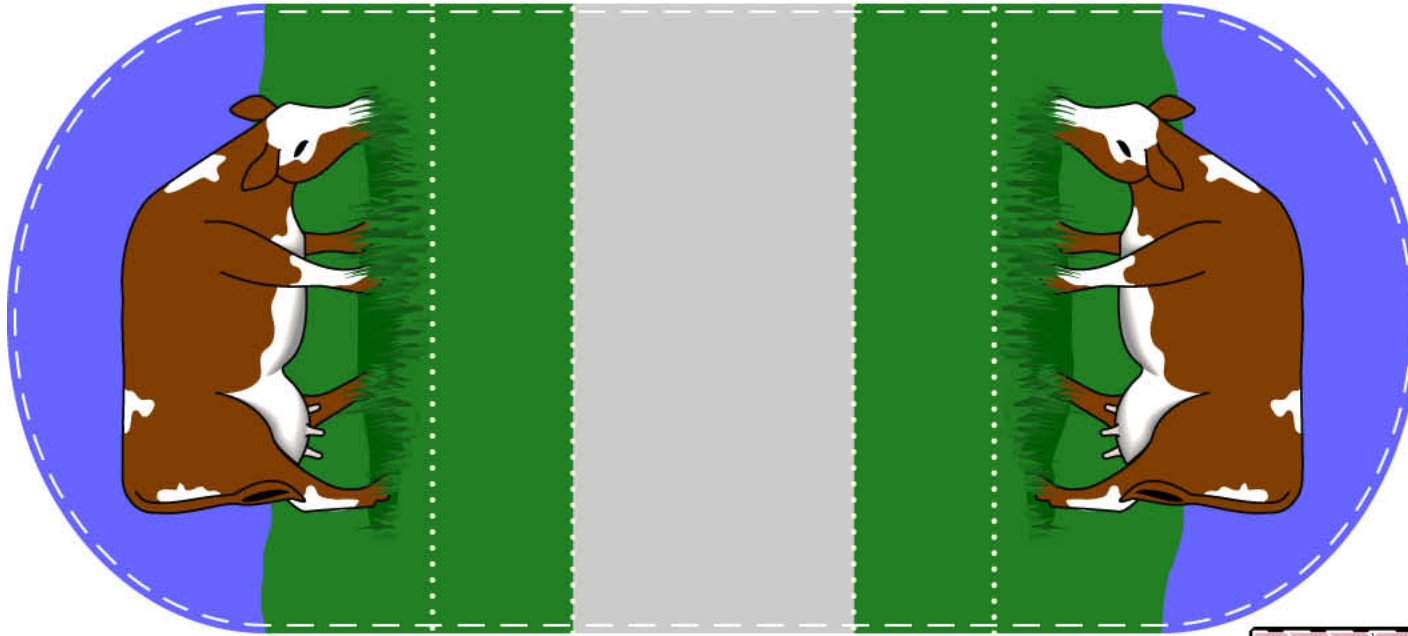

# Italian Villa

PRINT-n-PLAY TOYS

