

Советский магистральный грузовой электровоз постоянного тока

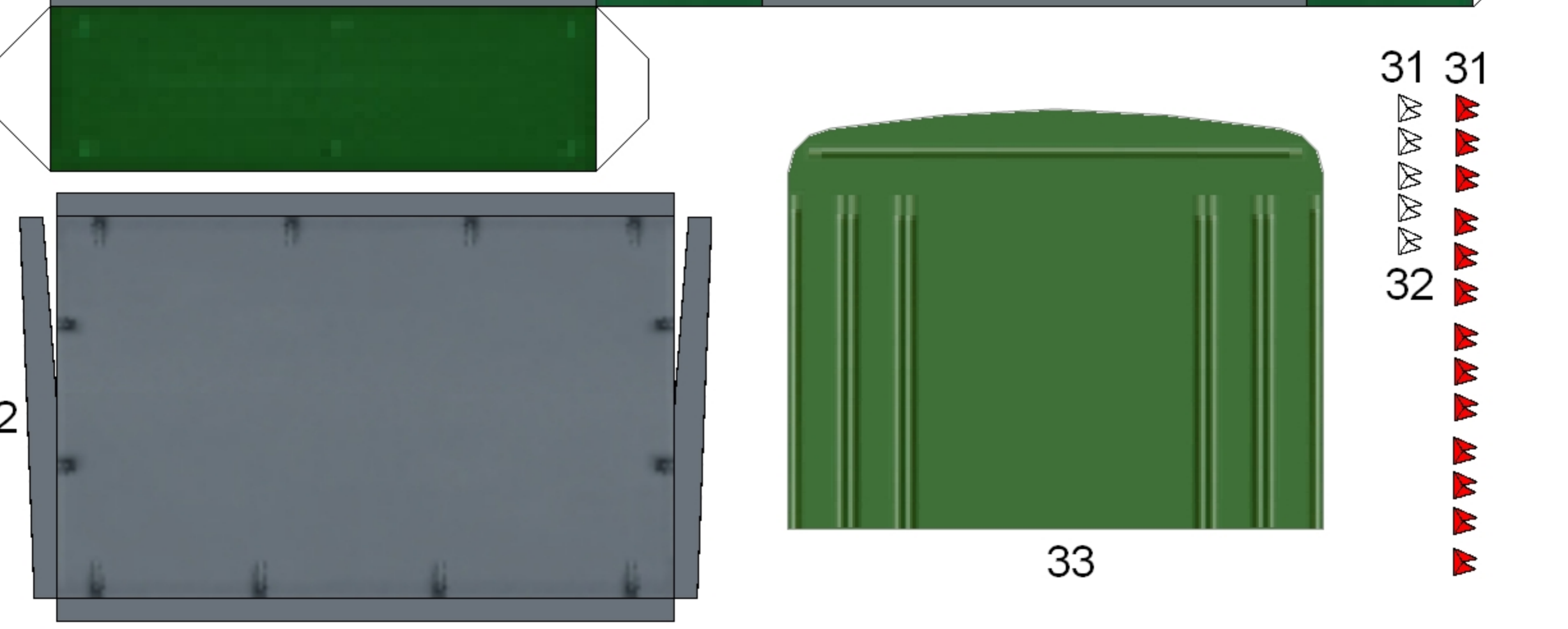

ВЛ10-1641

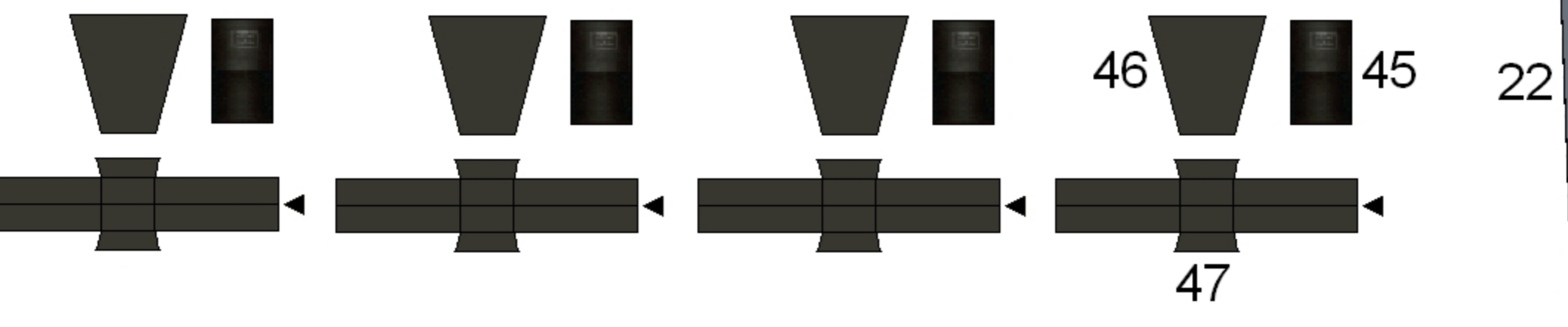

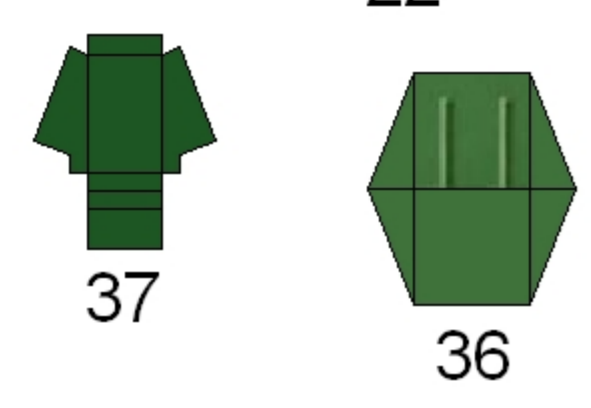
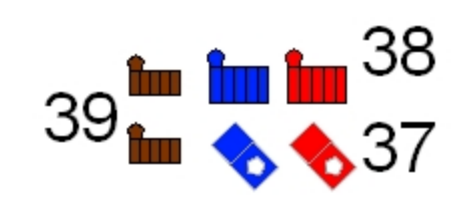
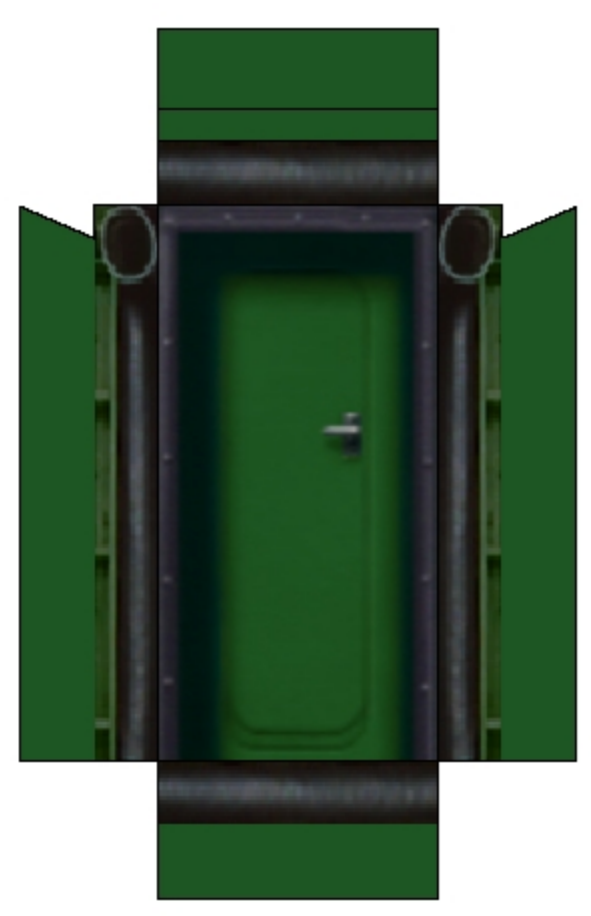
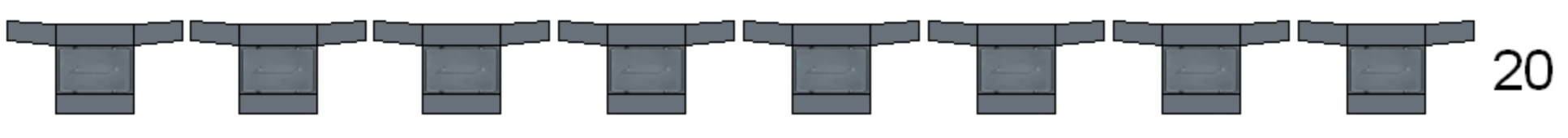
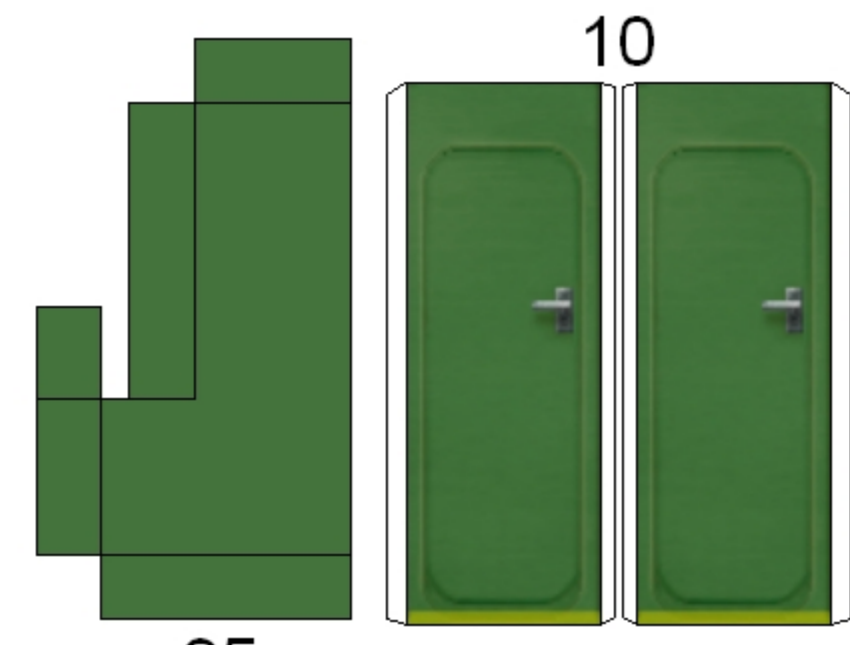
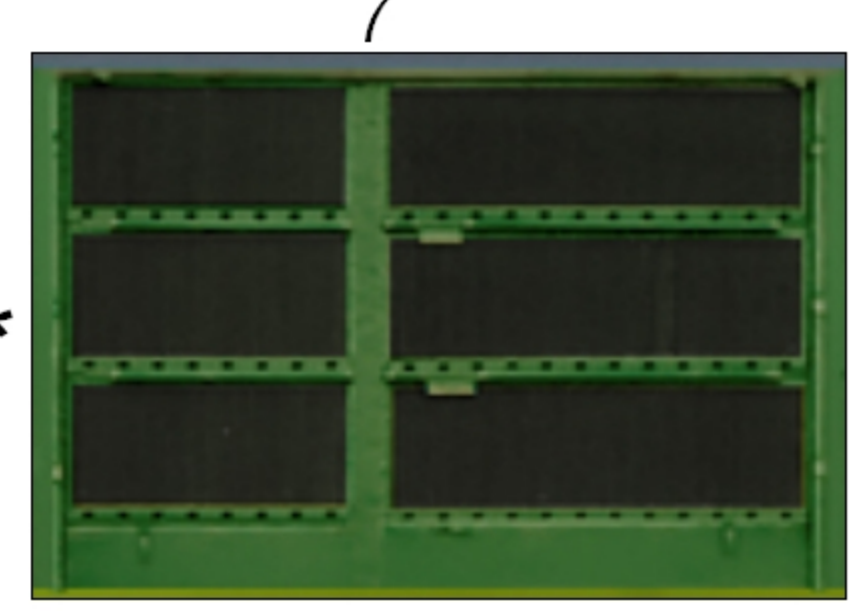
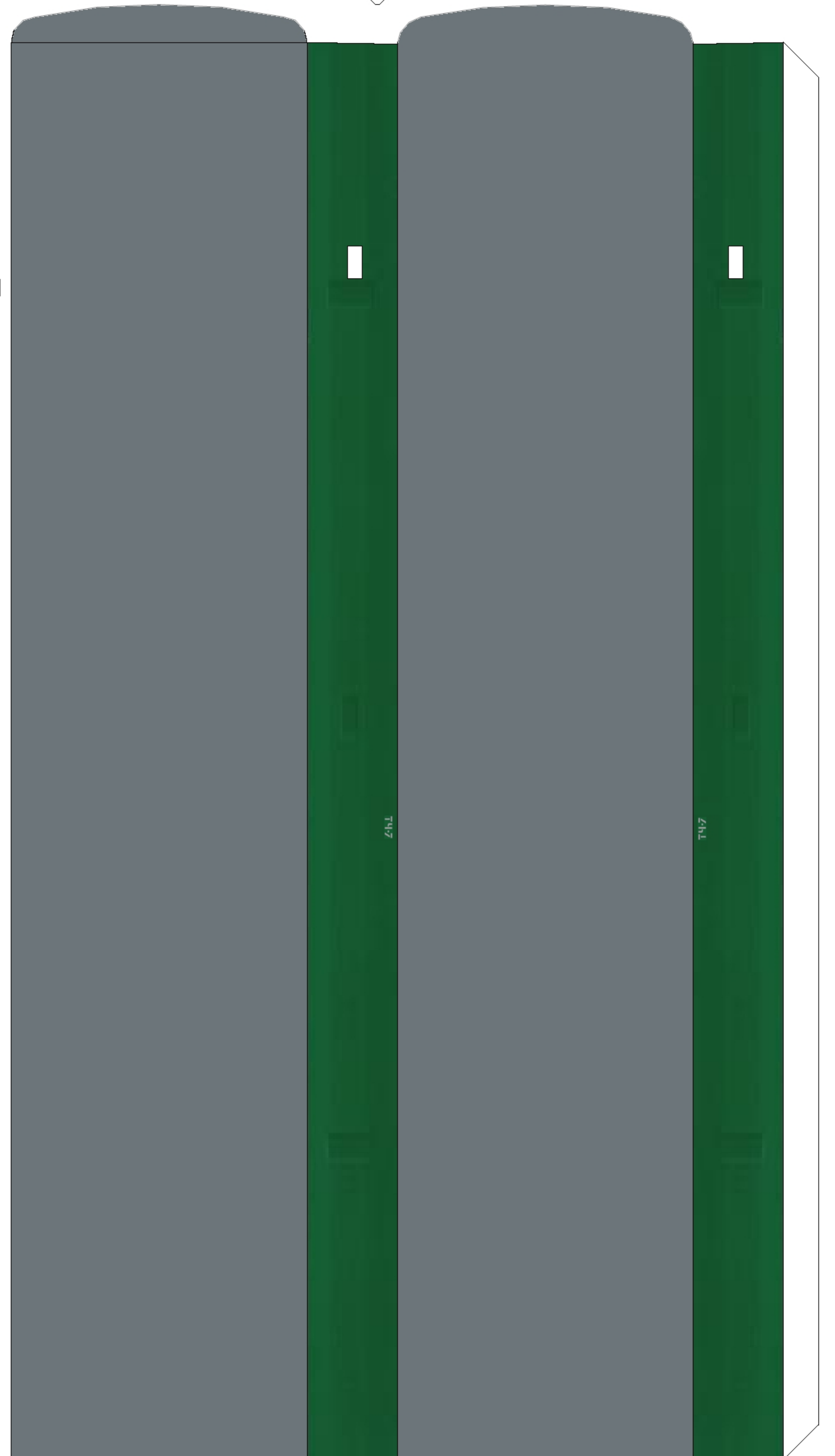
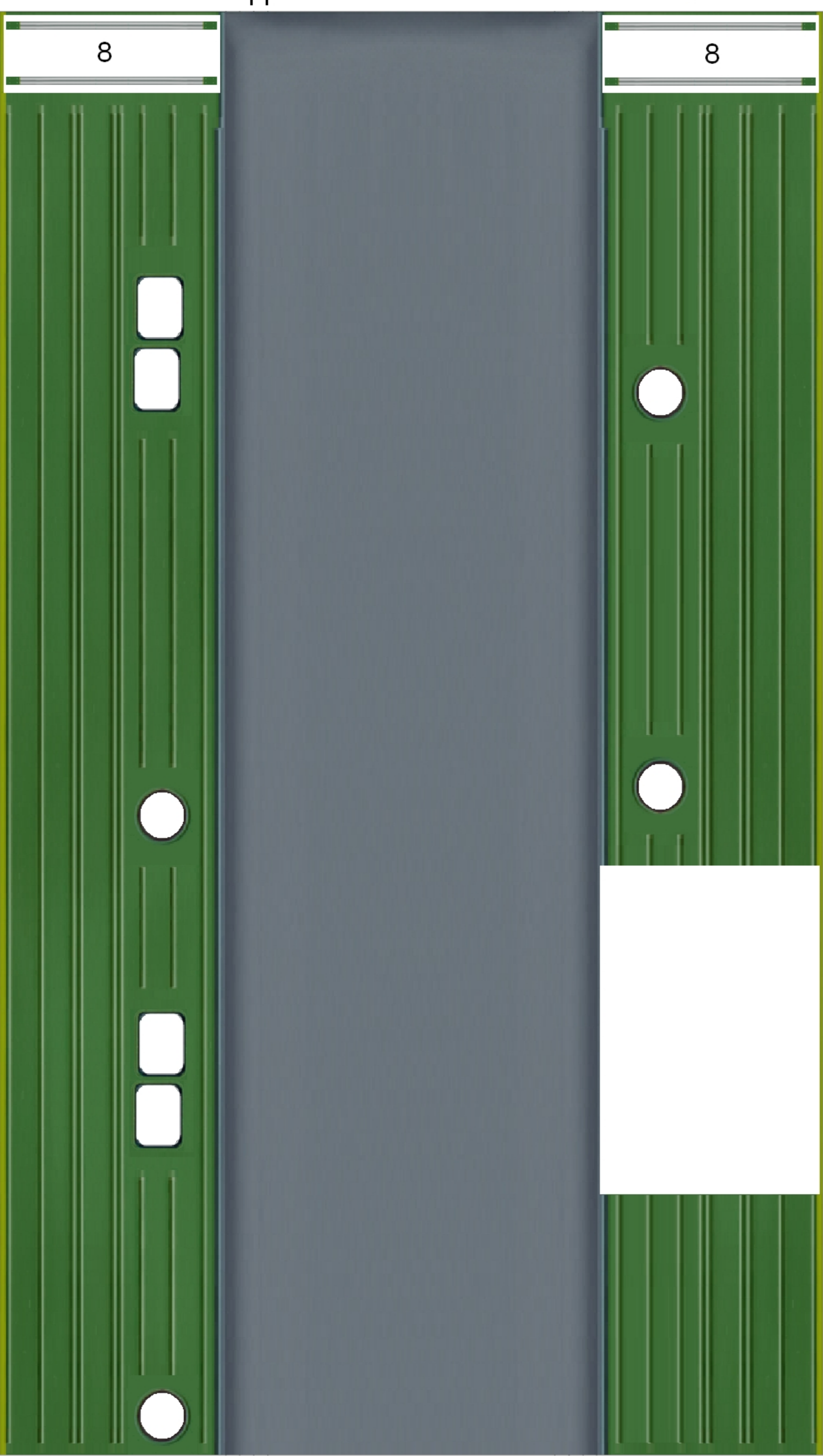
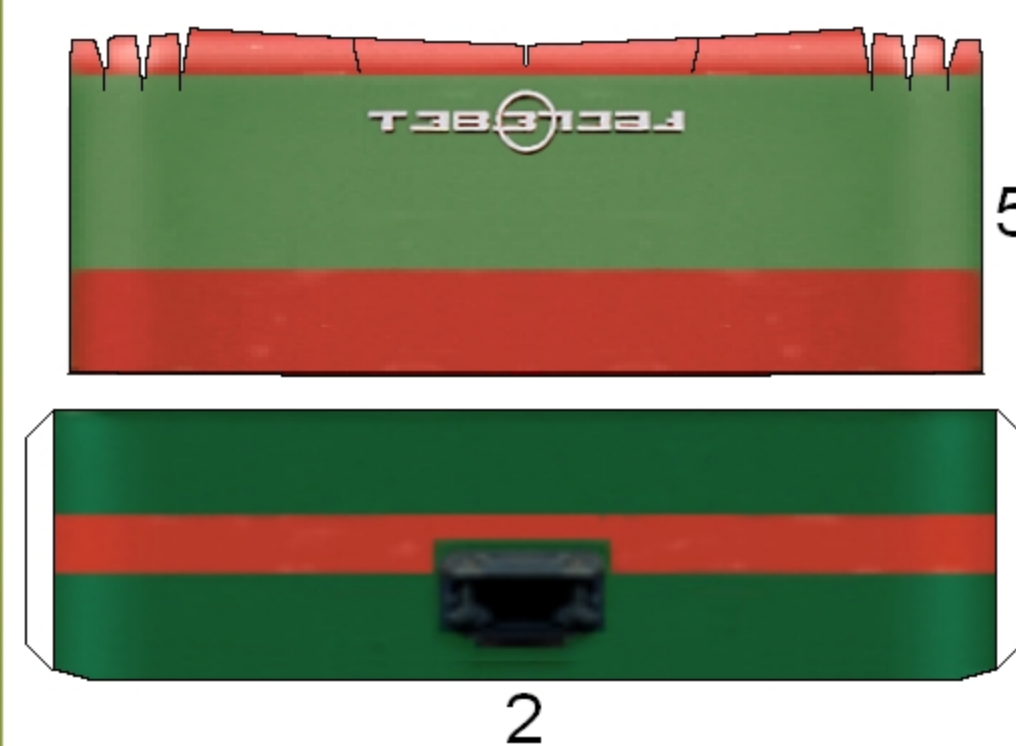
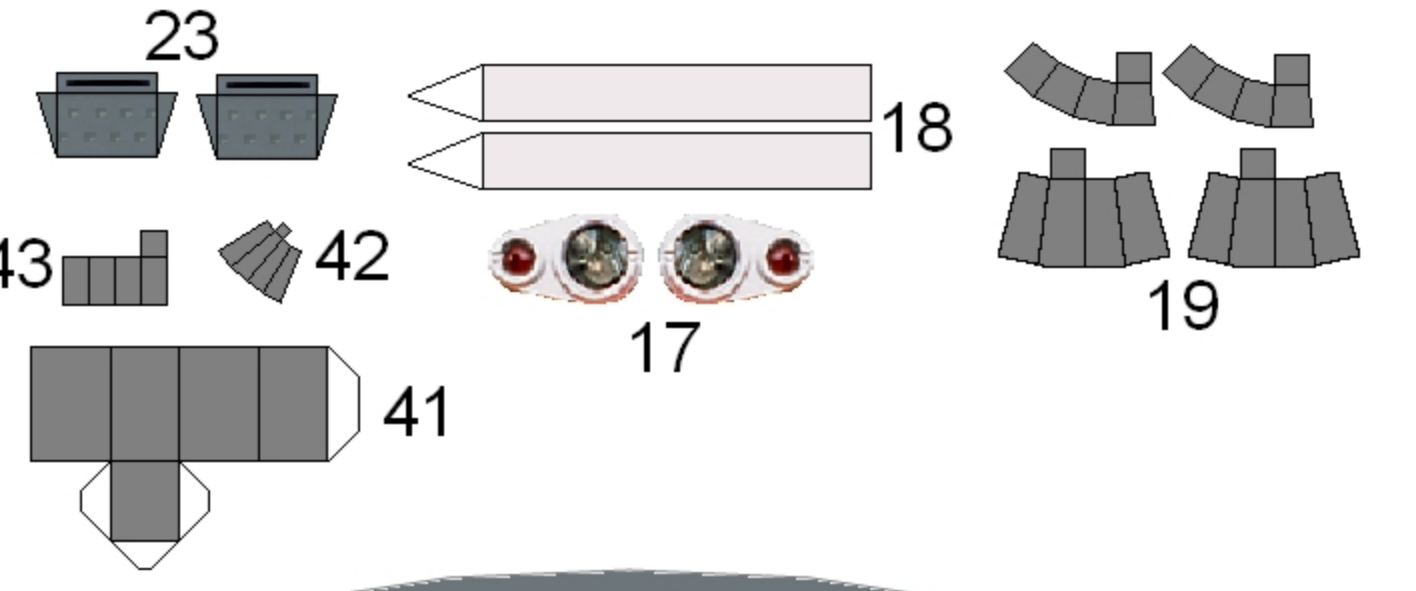
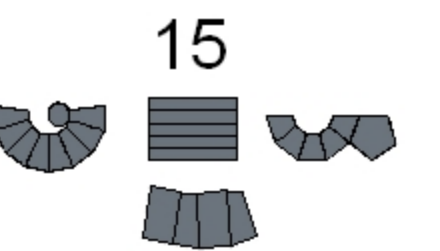
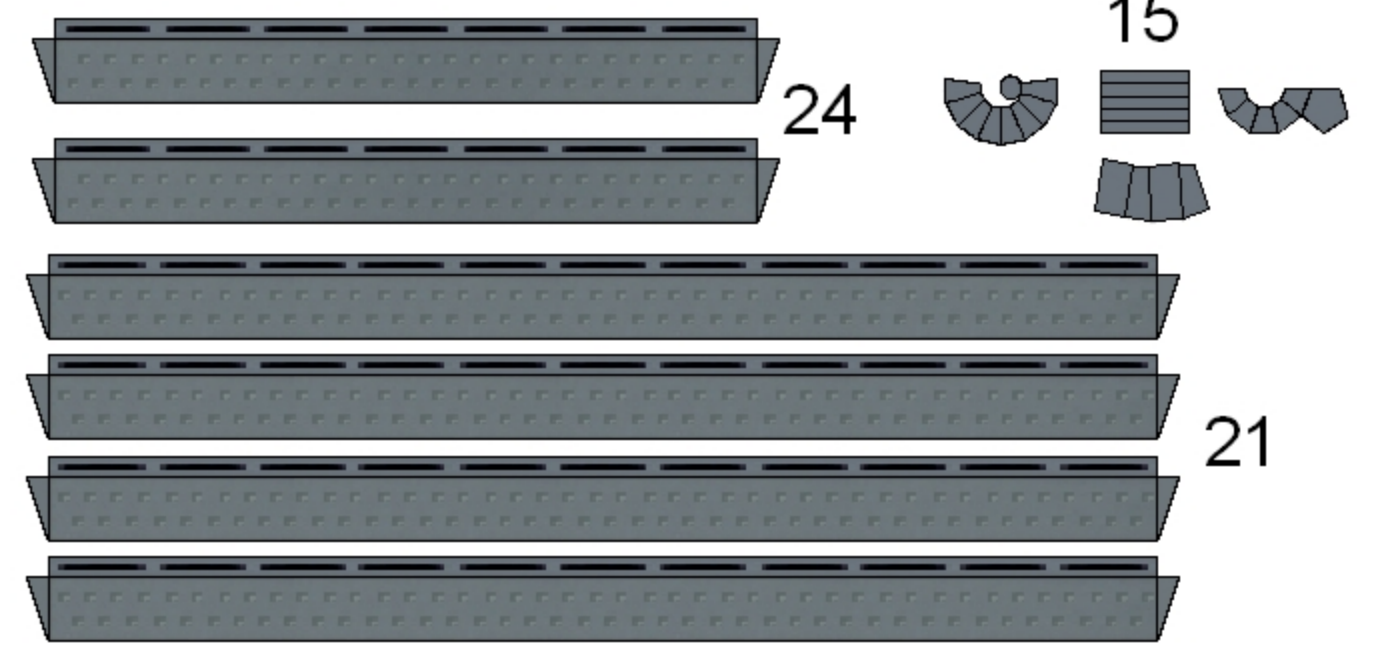
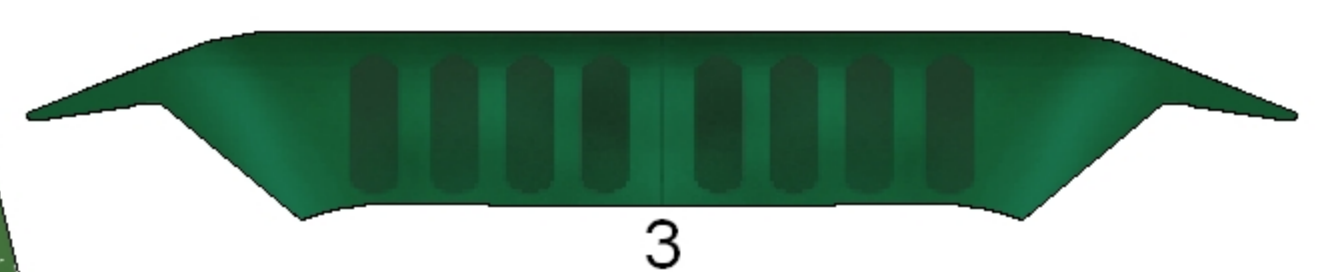
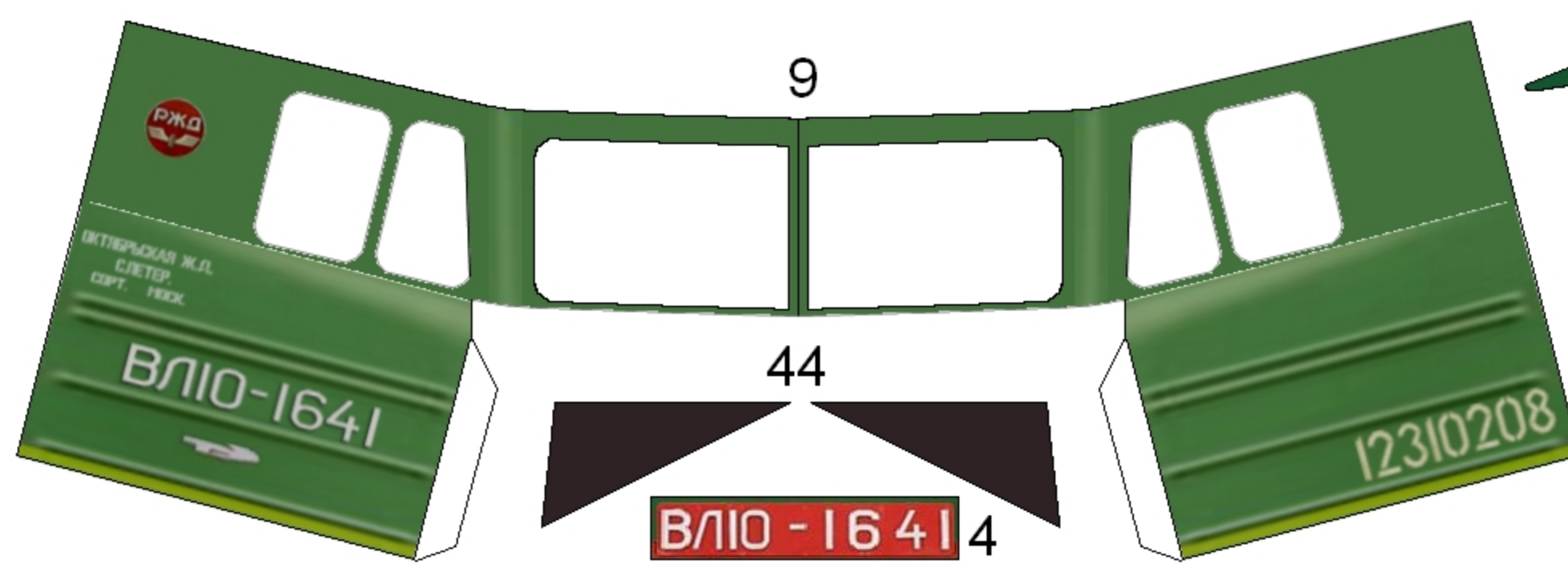
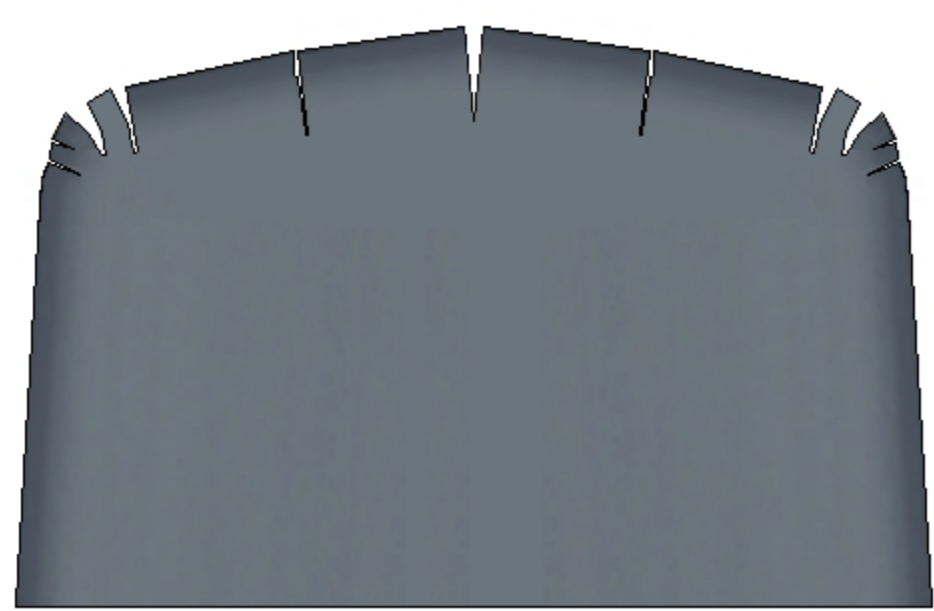
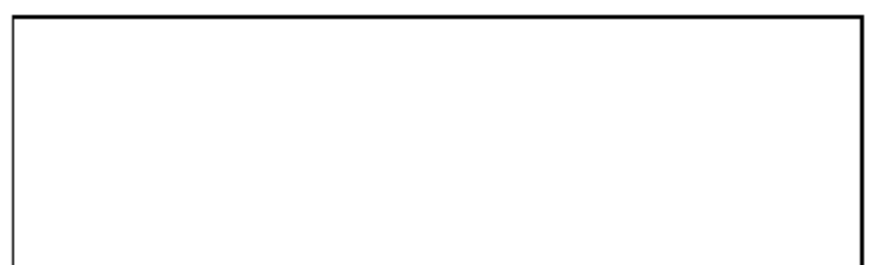
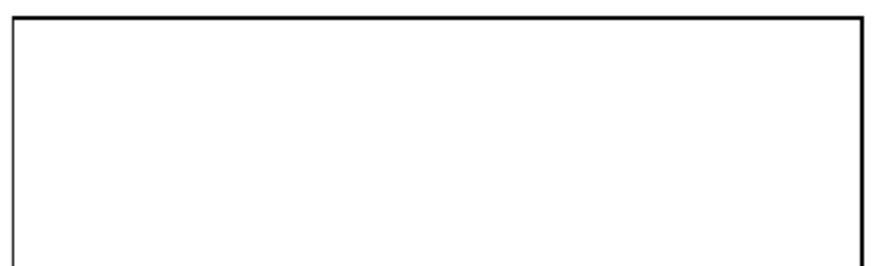
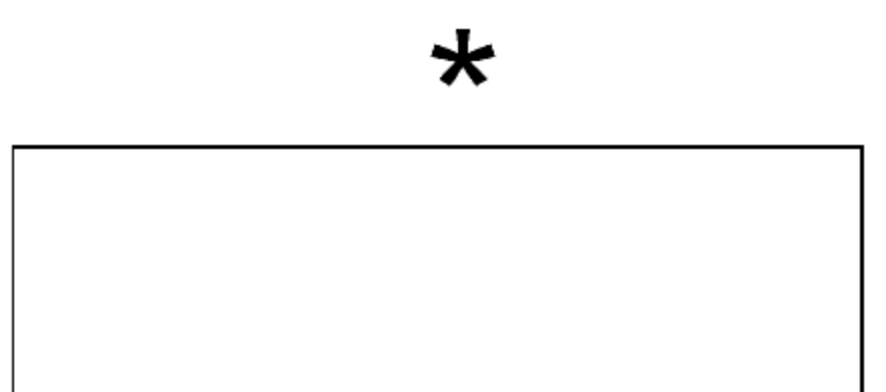
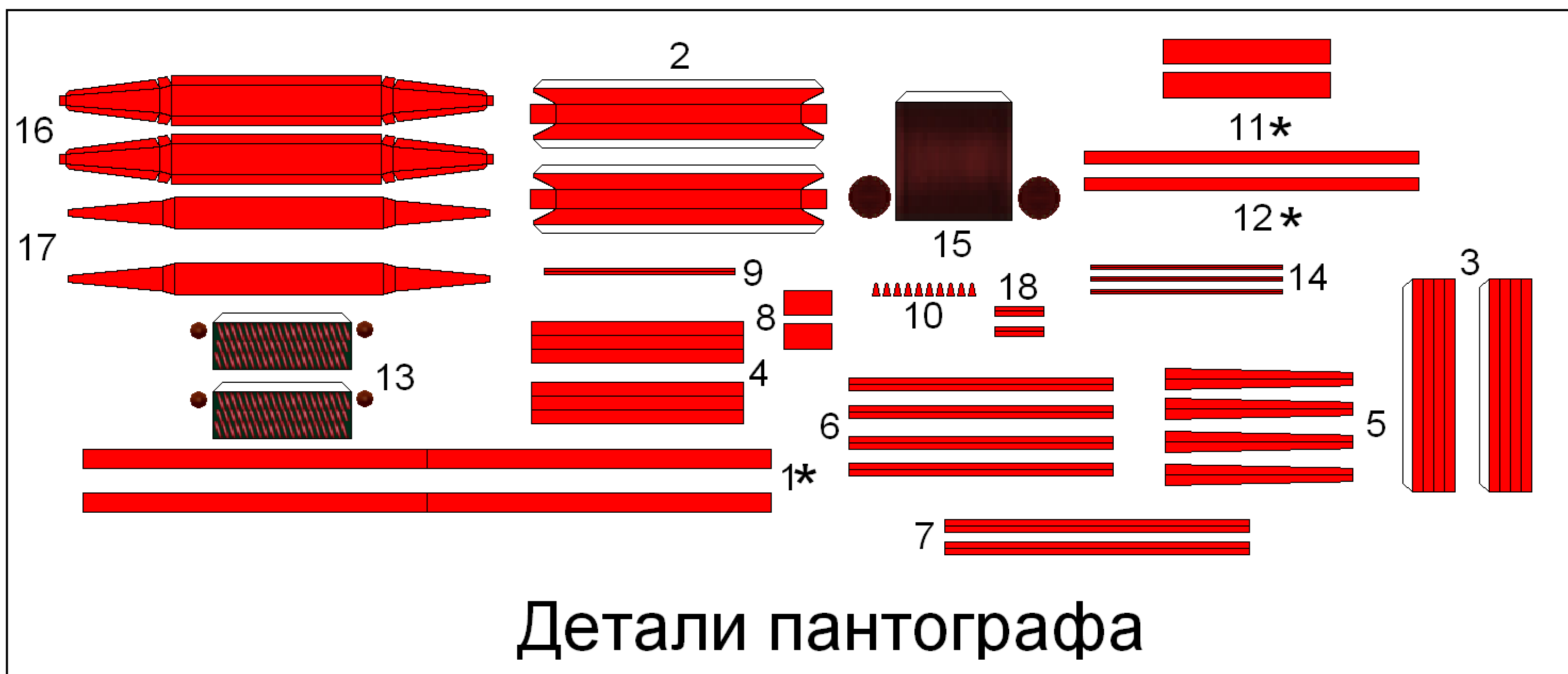
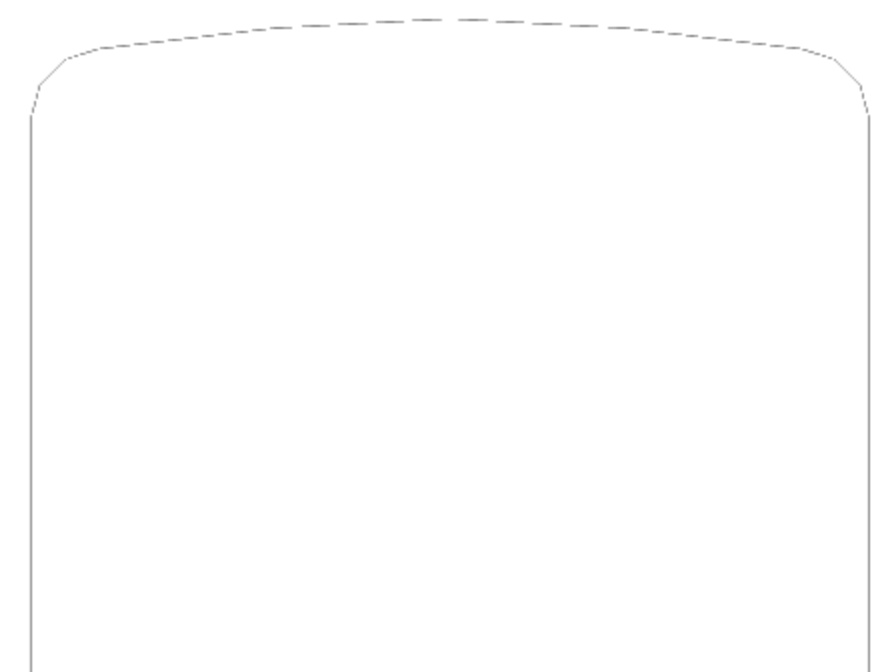
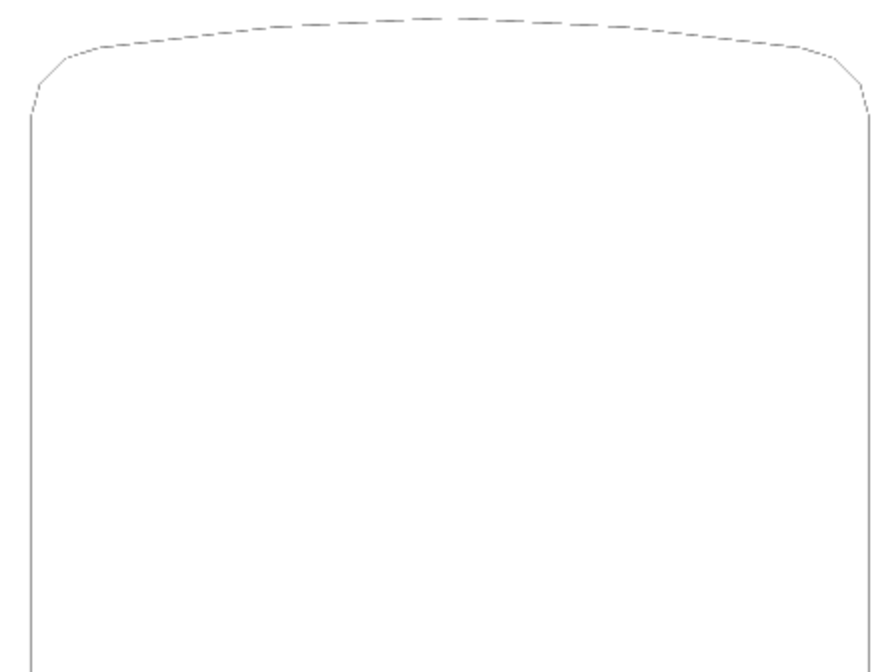
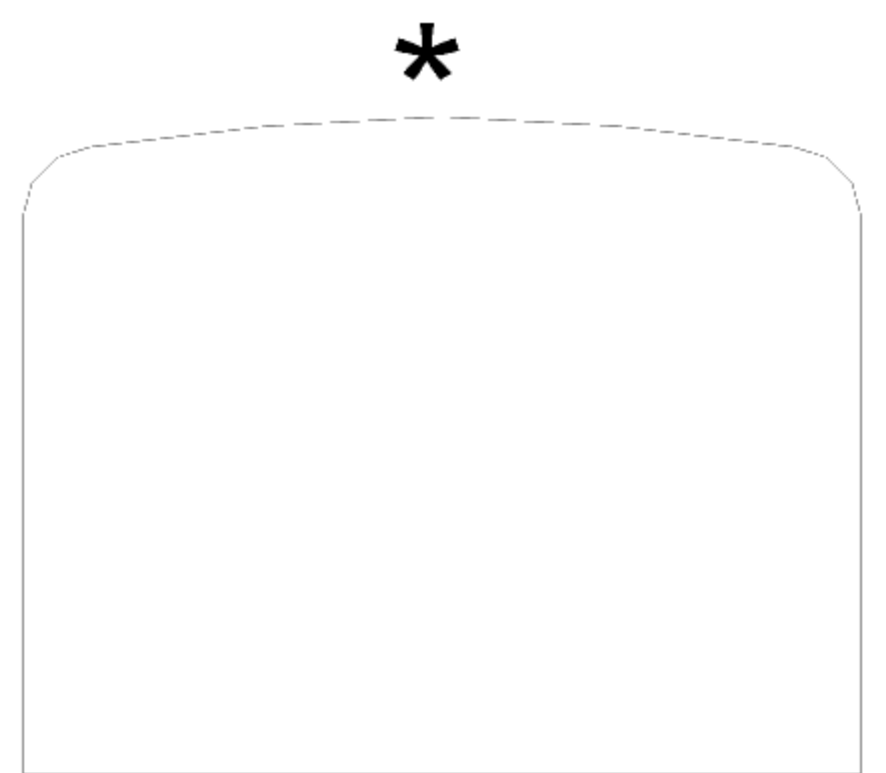
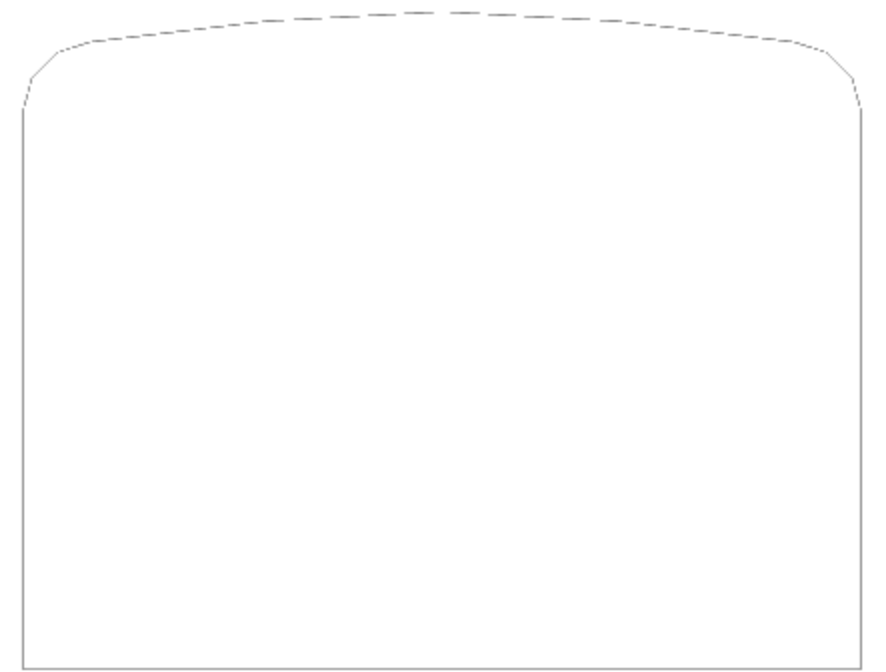
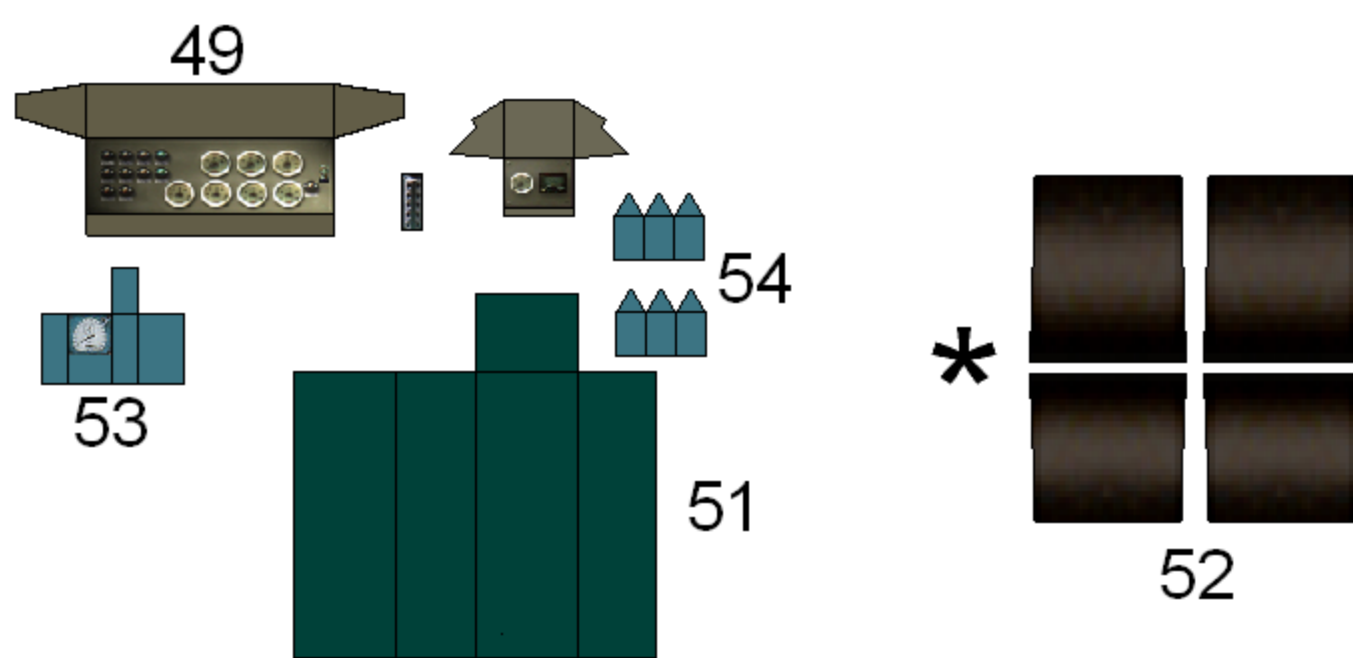
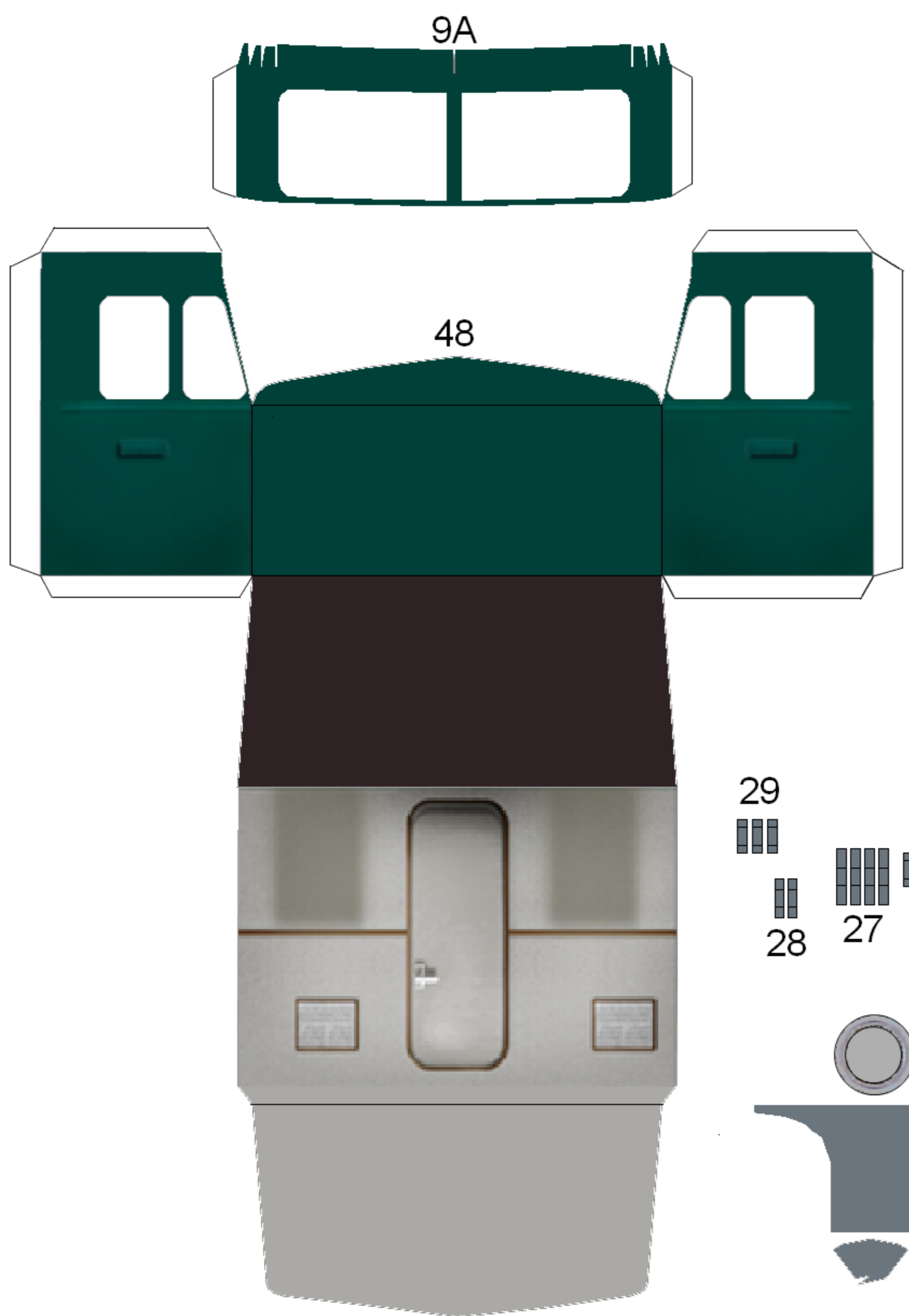

Инструкция

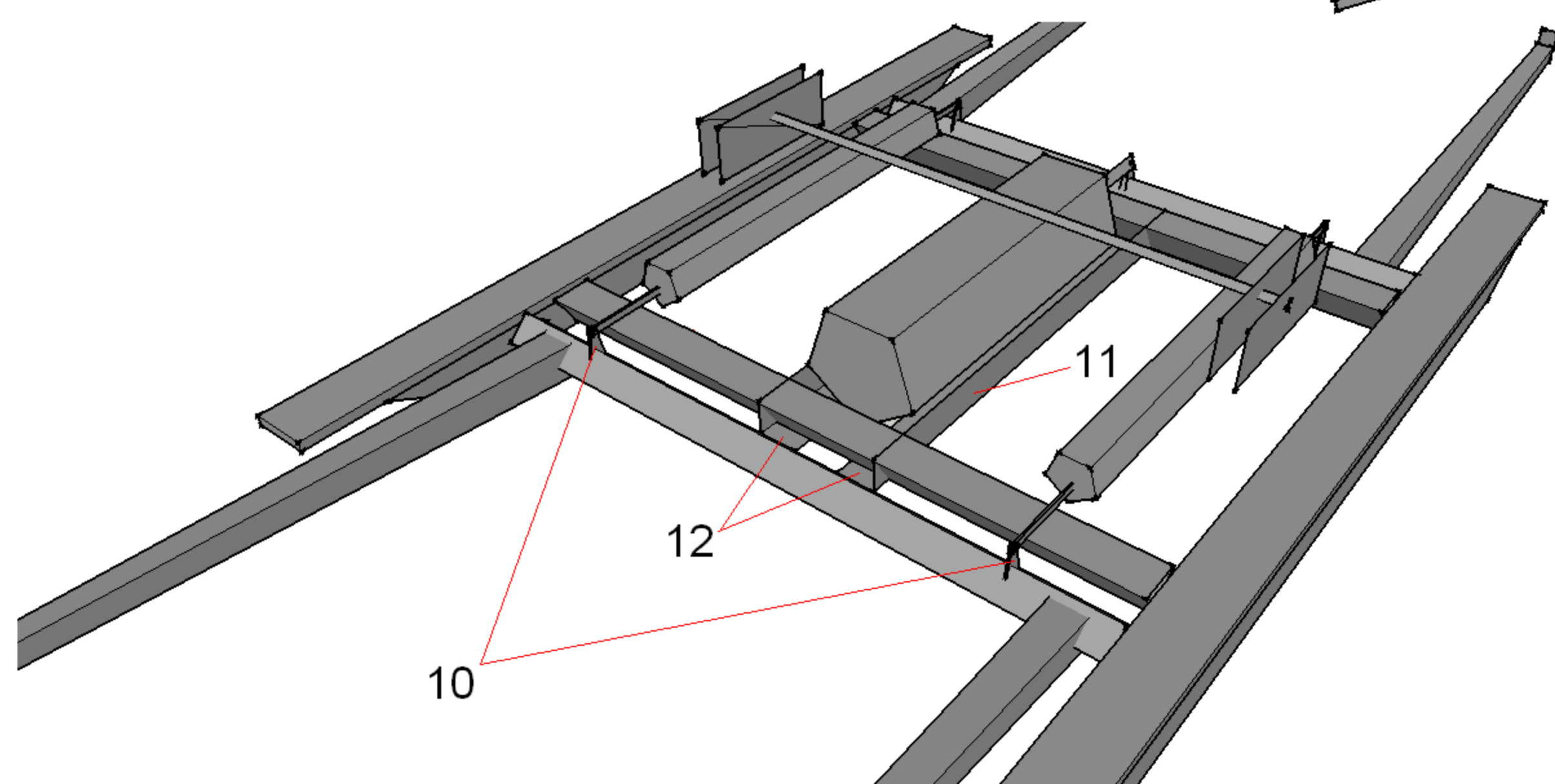
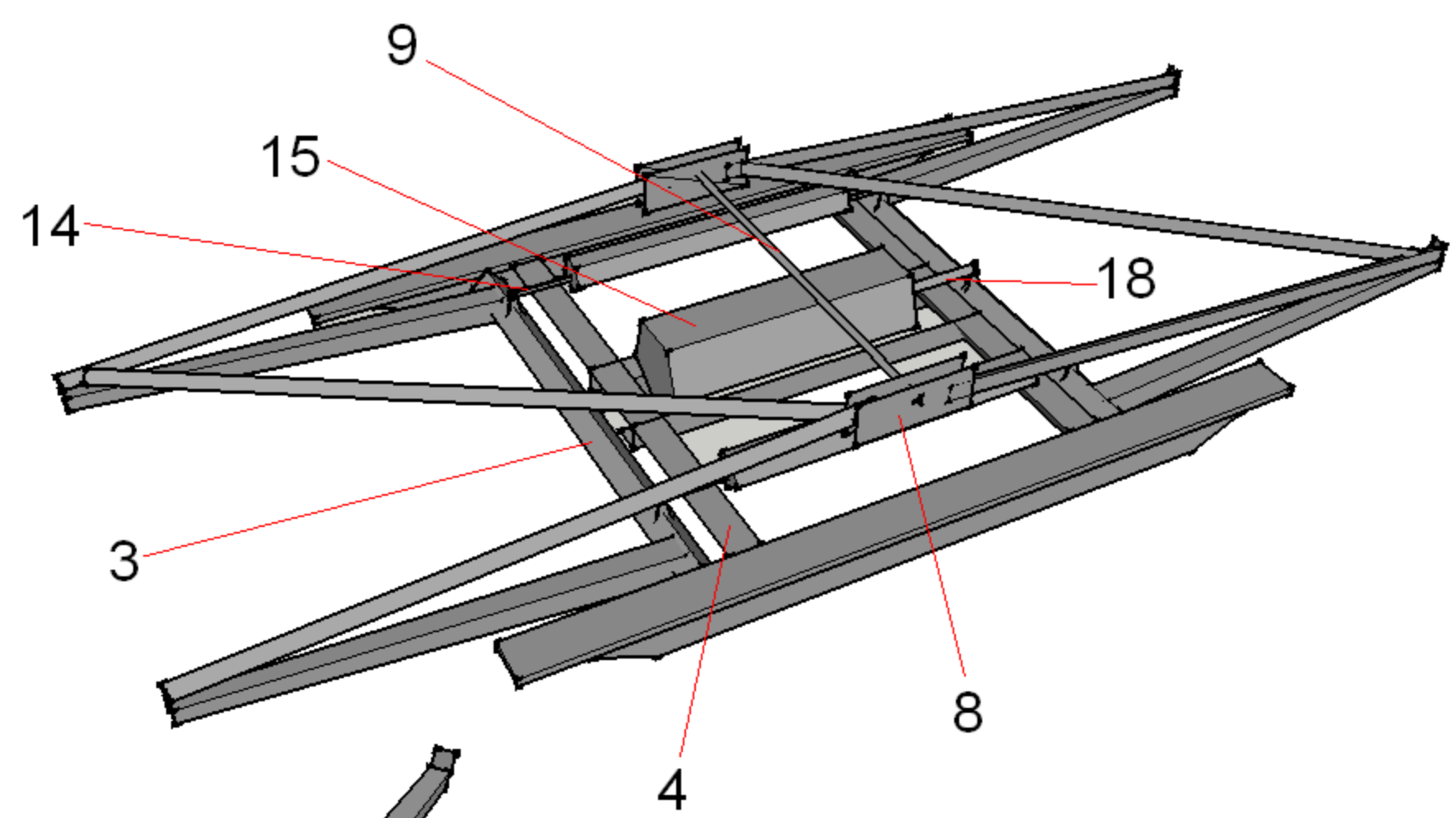
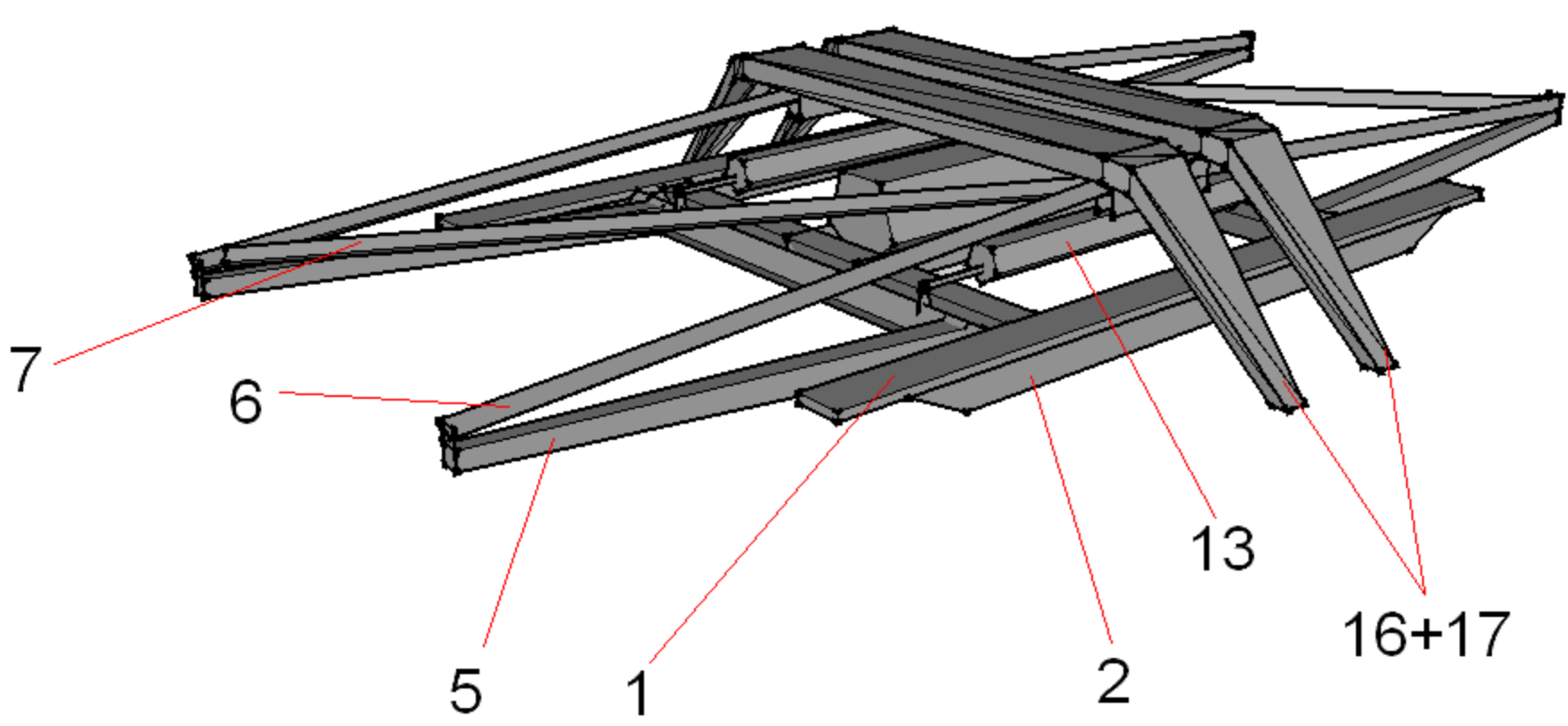

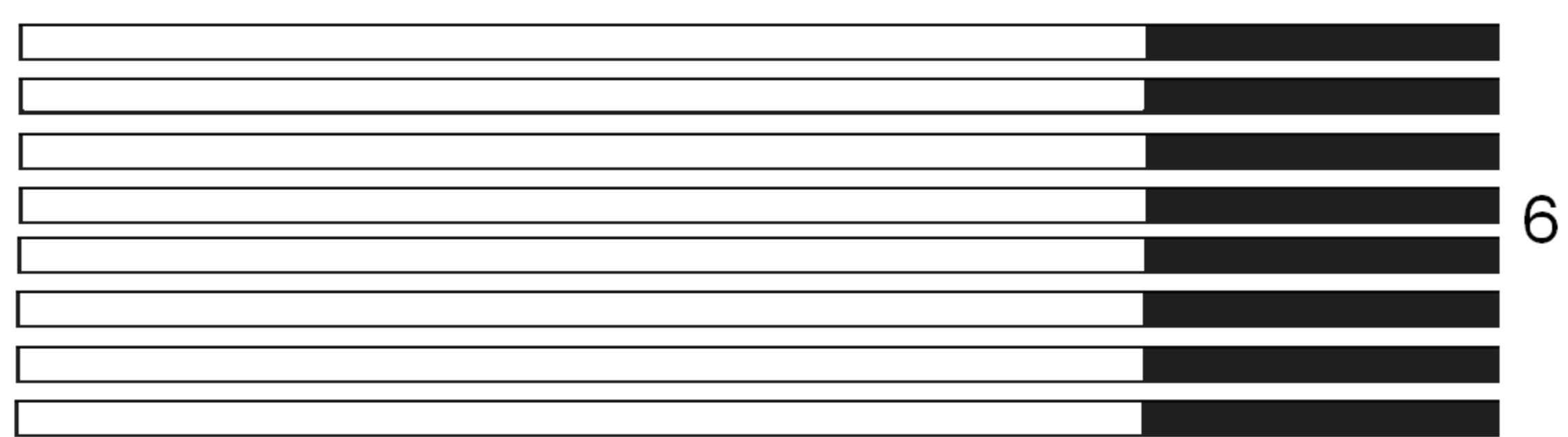
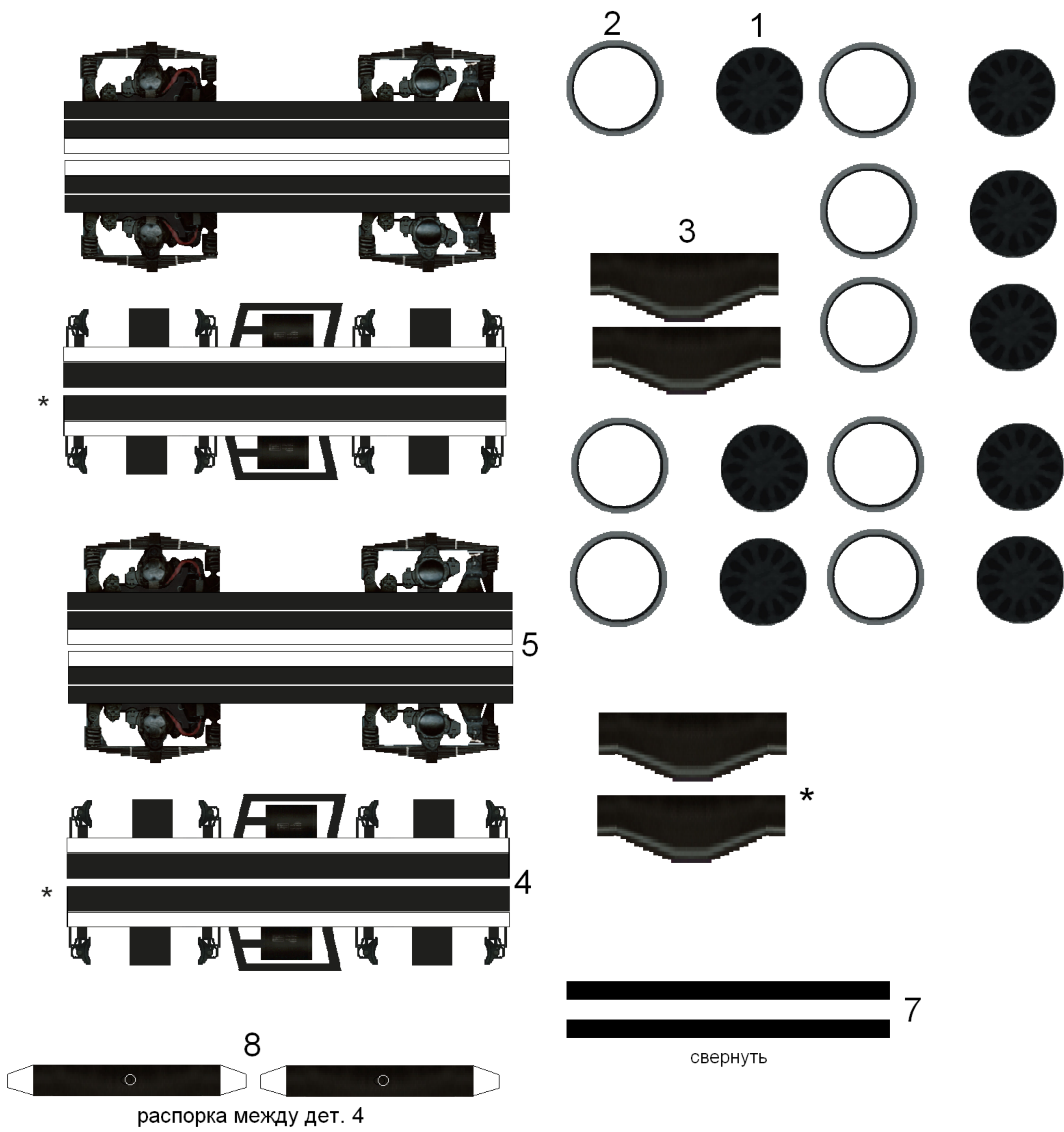

свернуть и одеть на оси между 4 и 5 дет

