

тепловоз с электрической передачей

ТЭП60

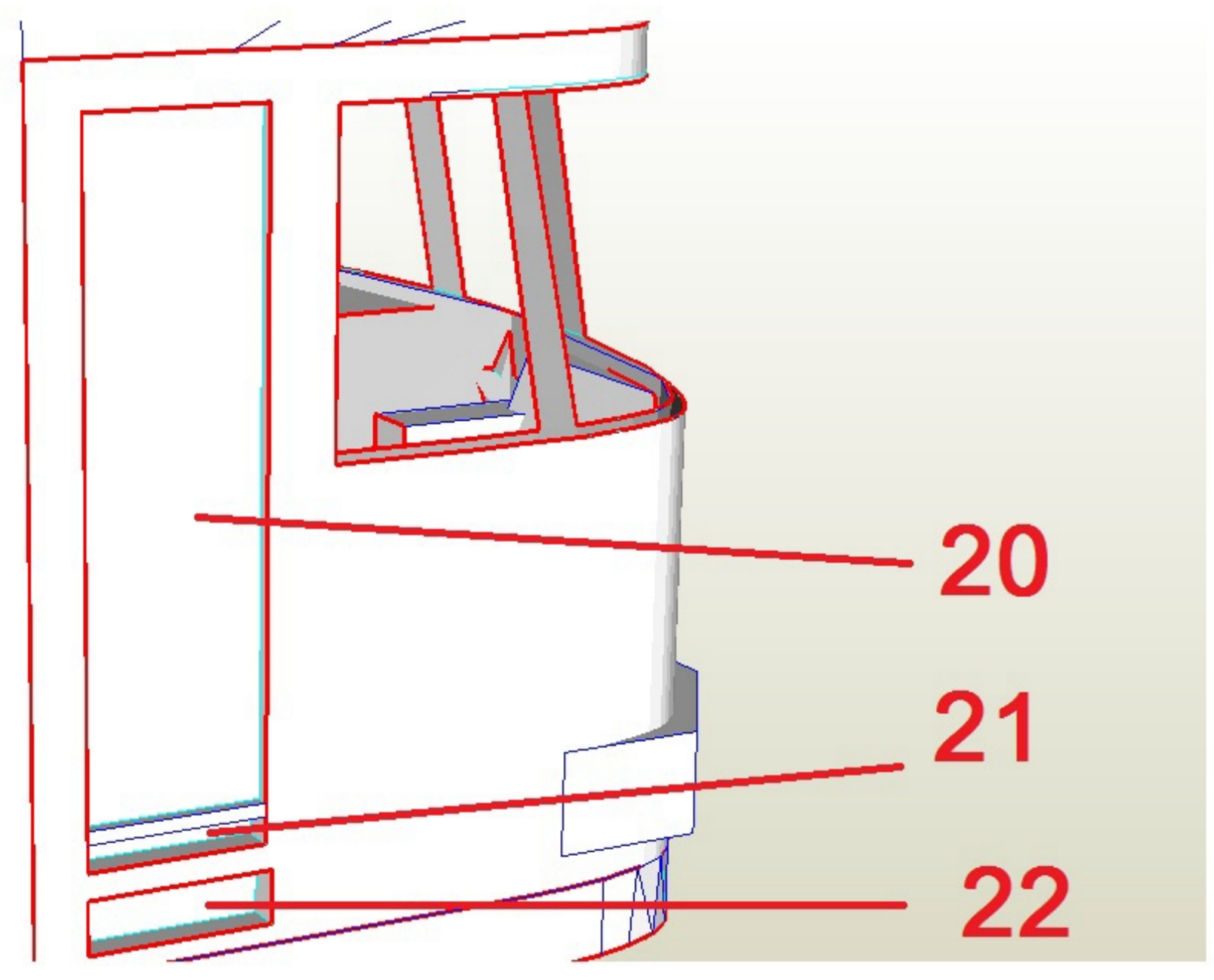

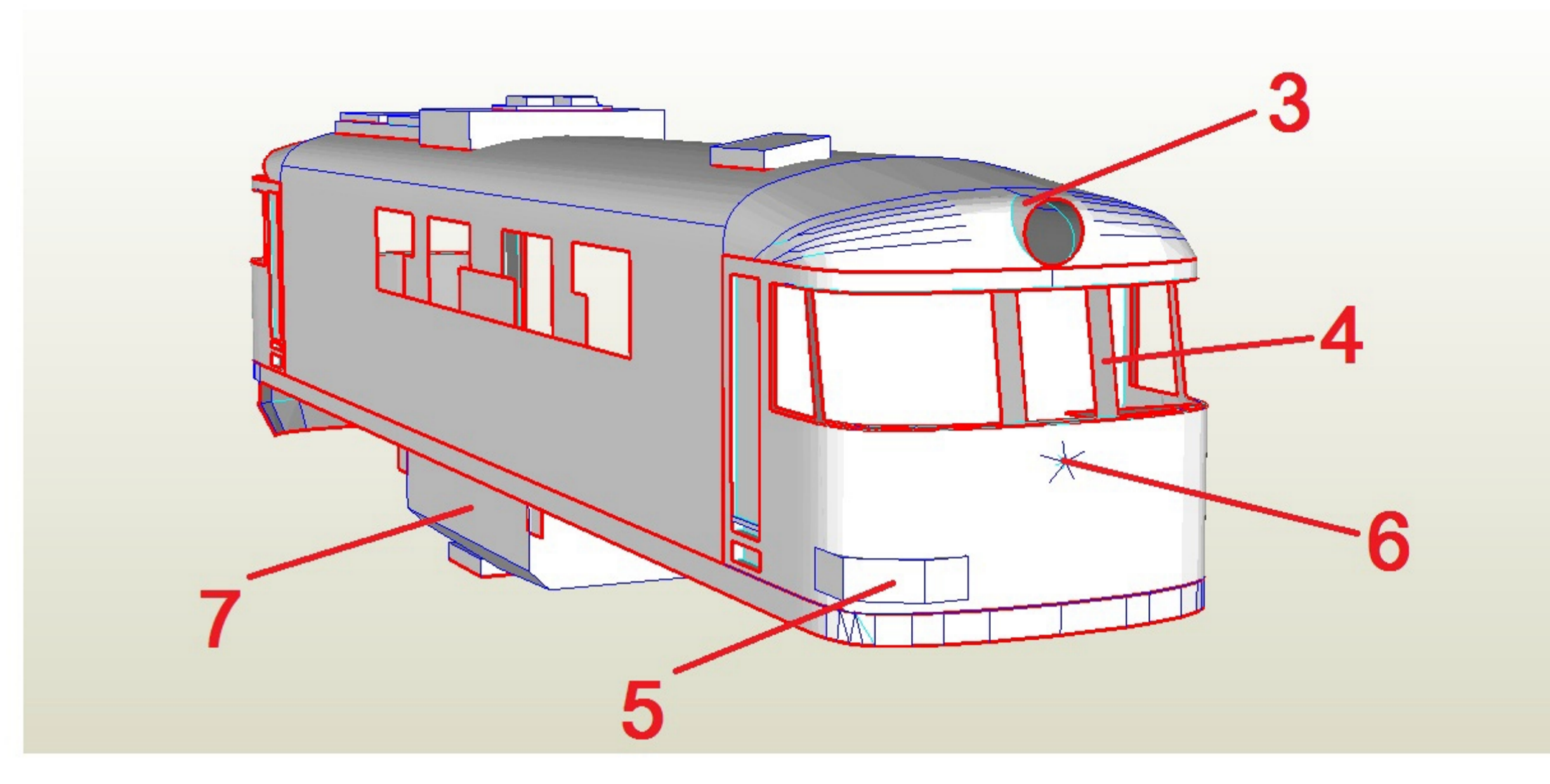

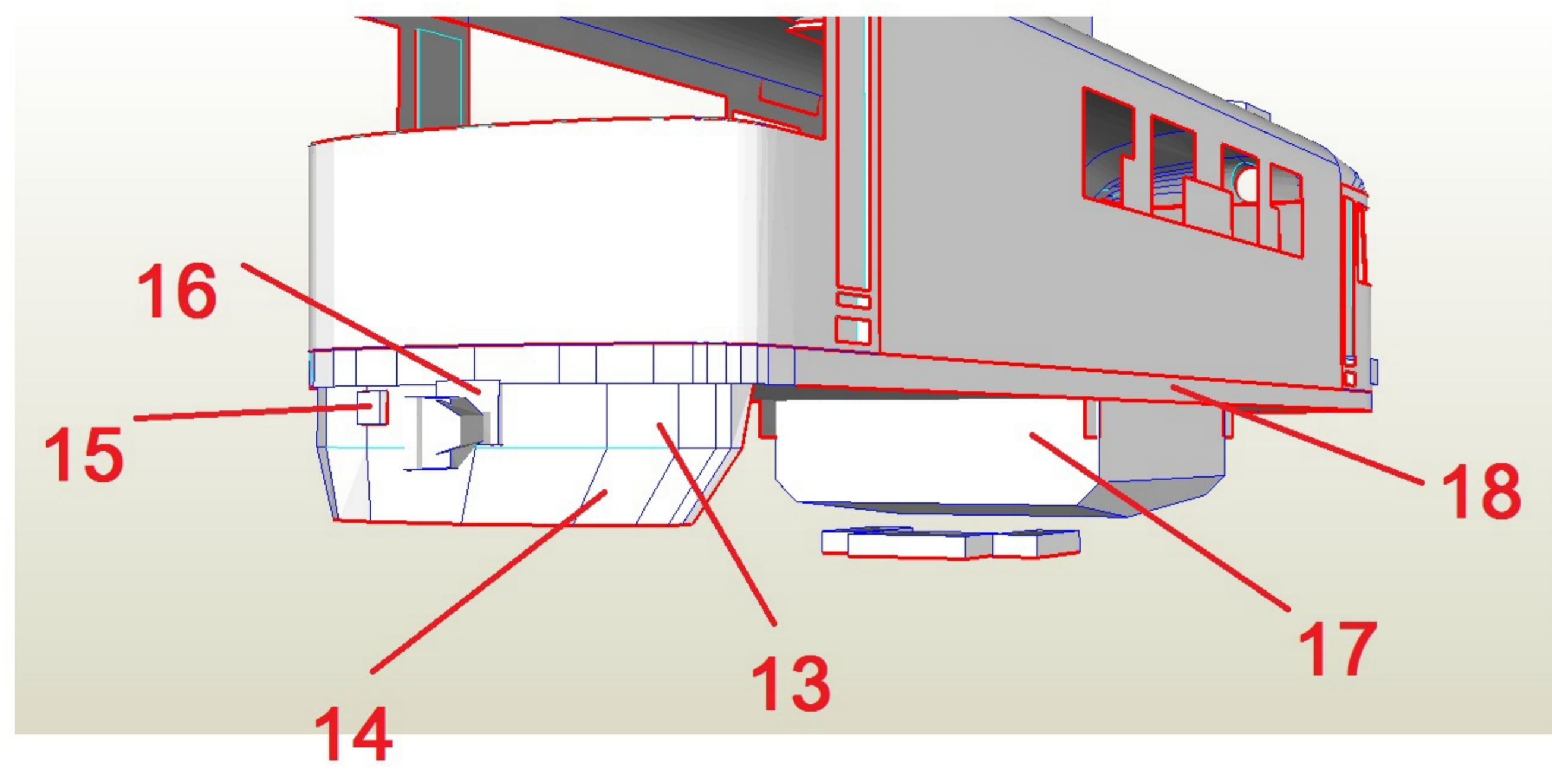
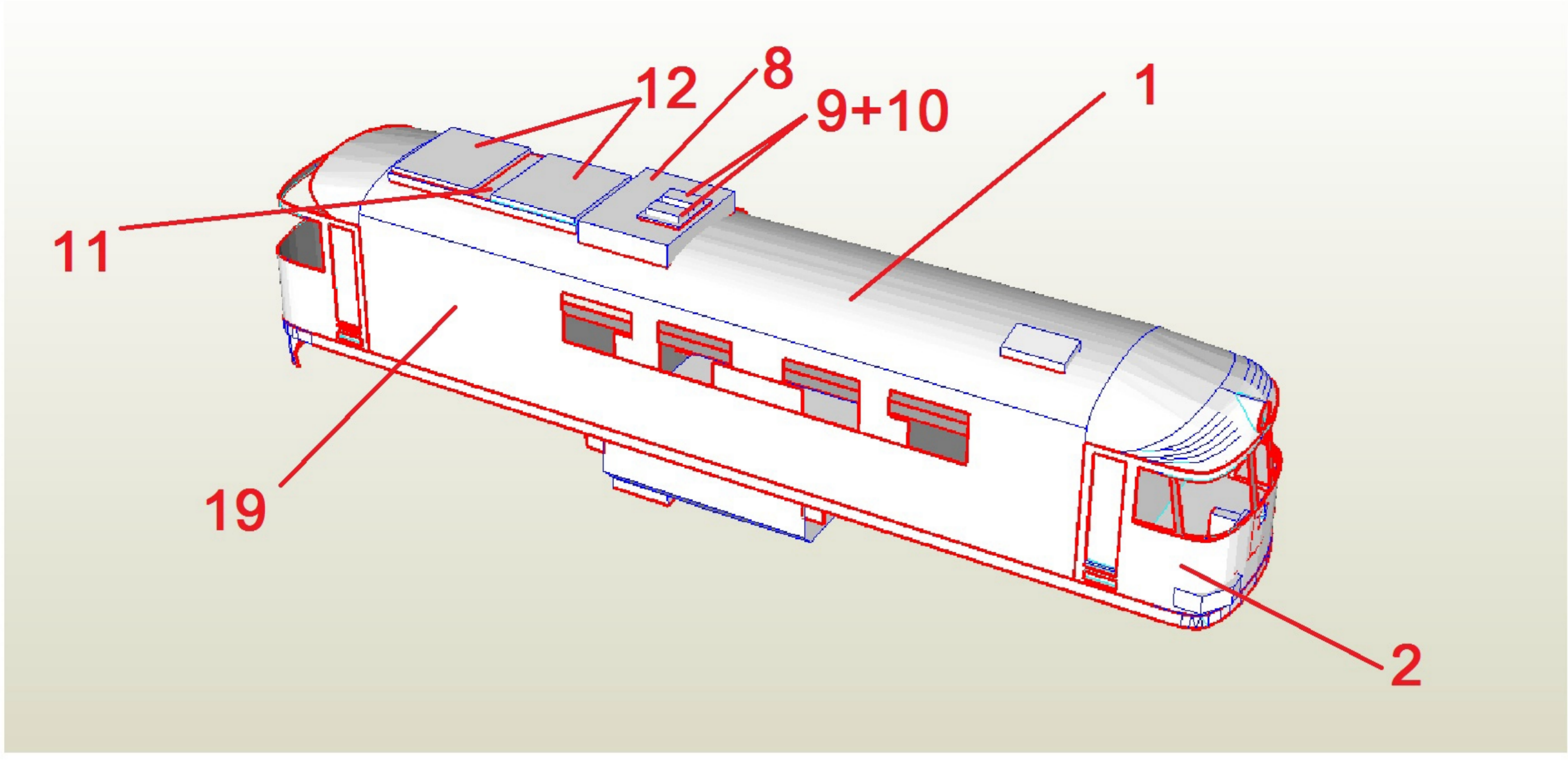
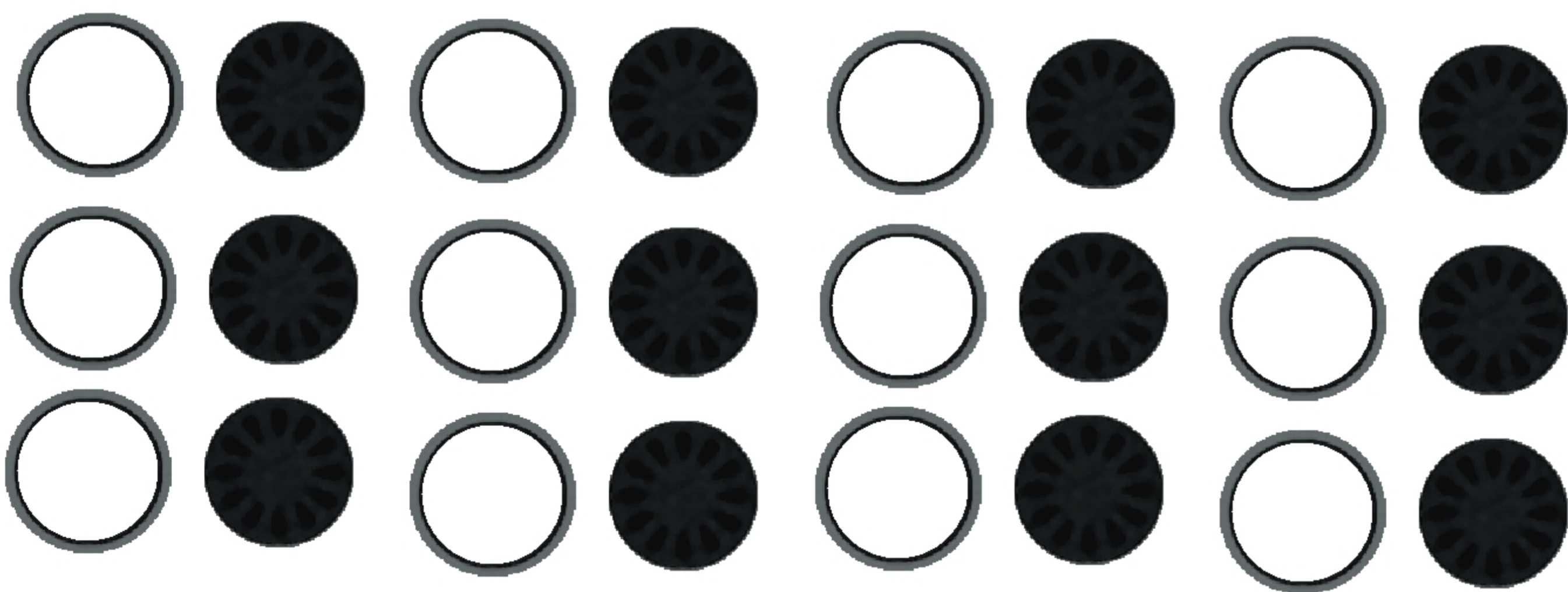
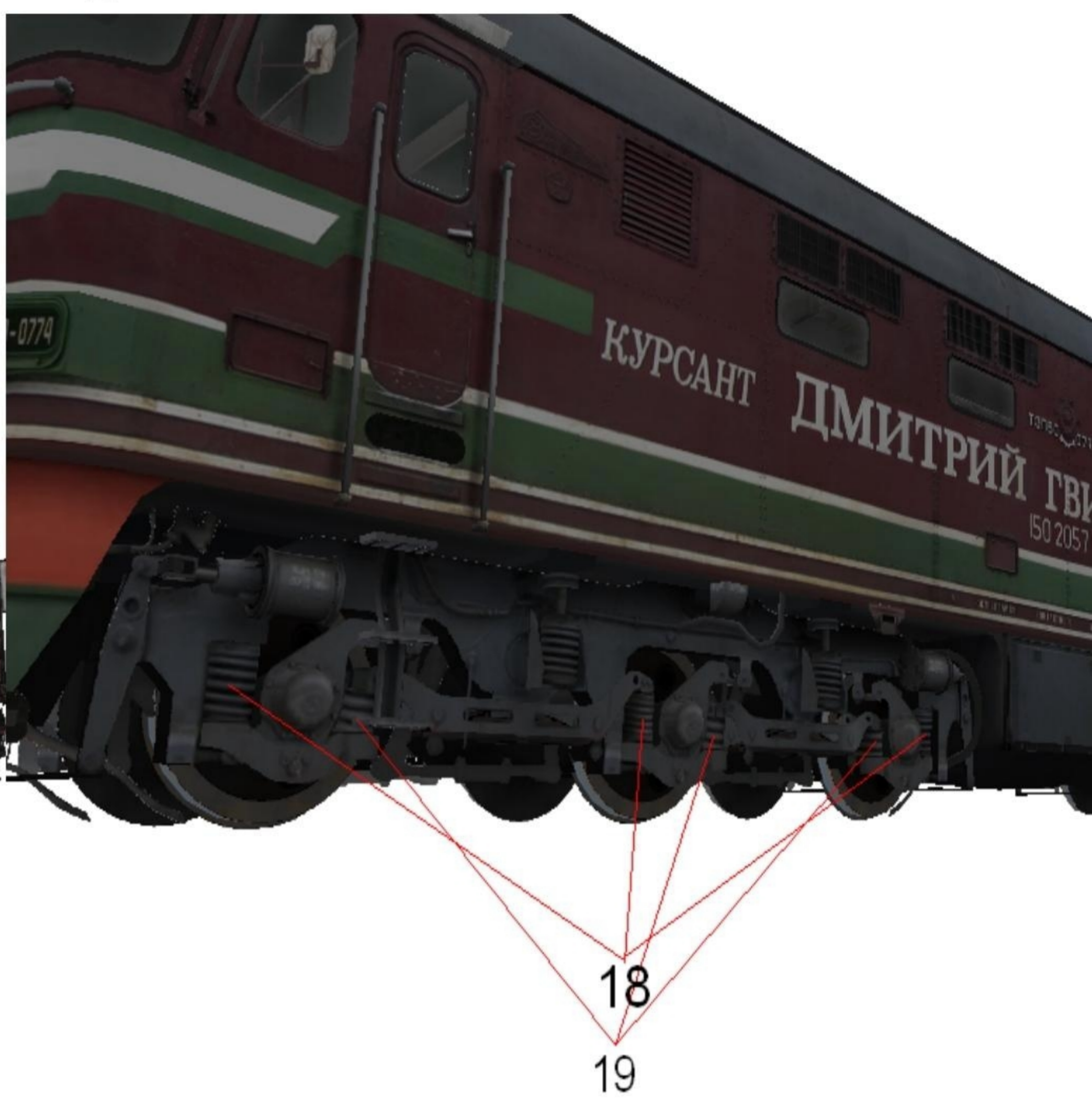
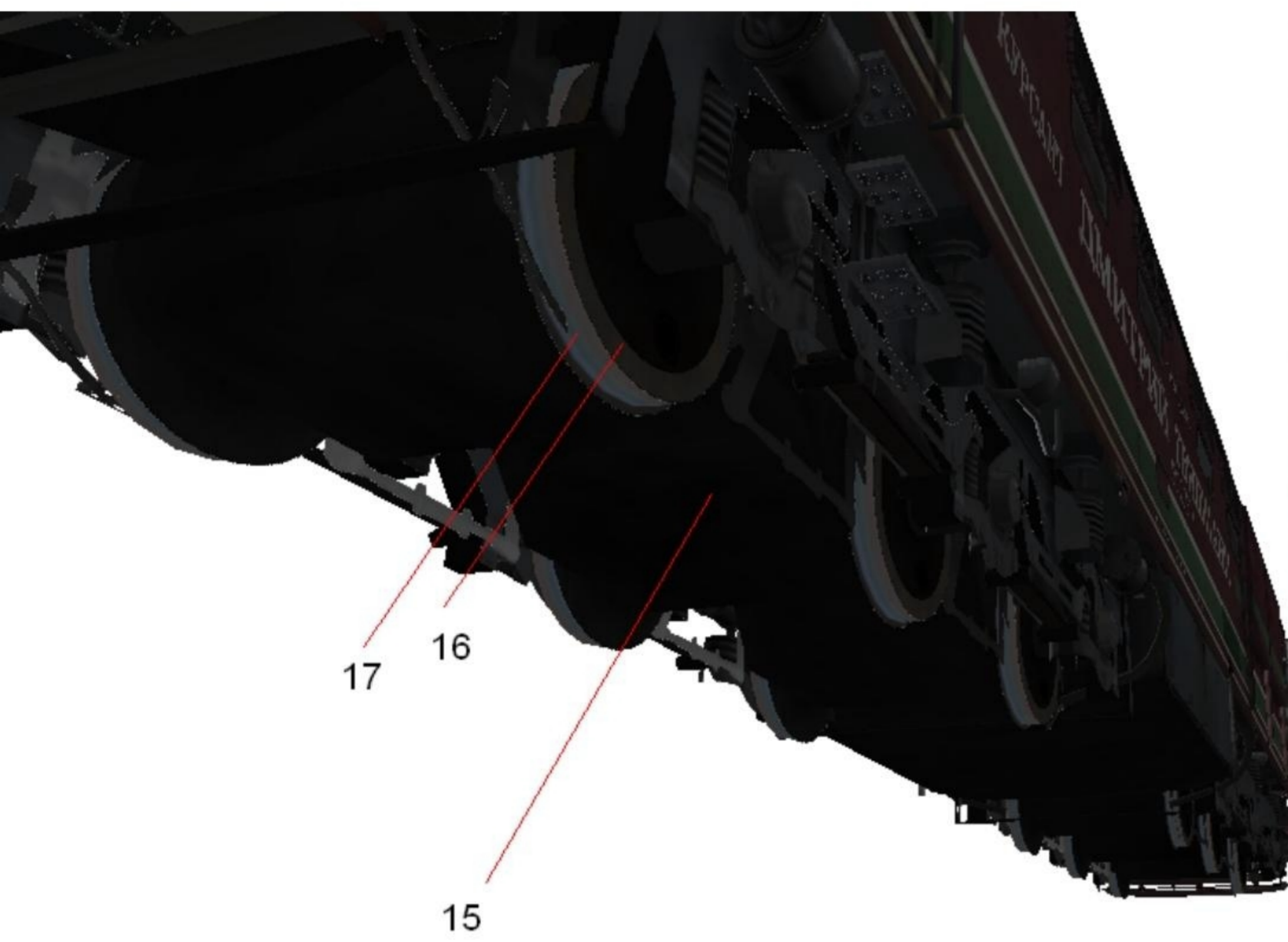
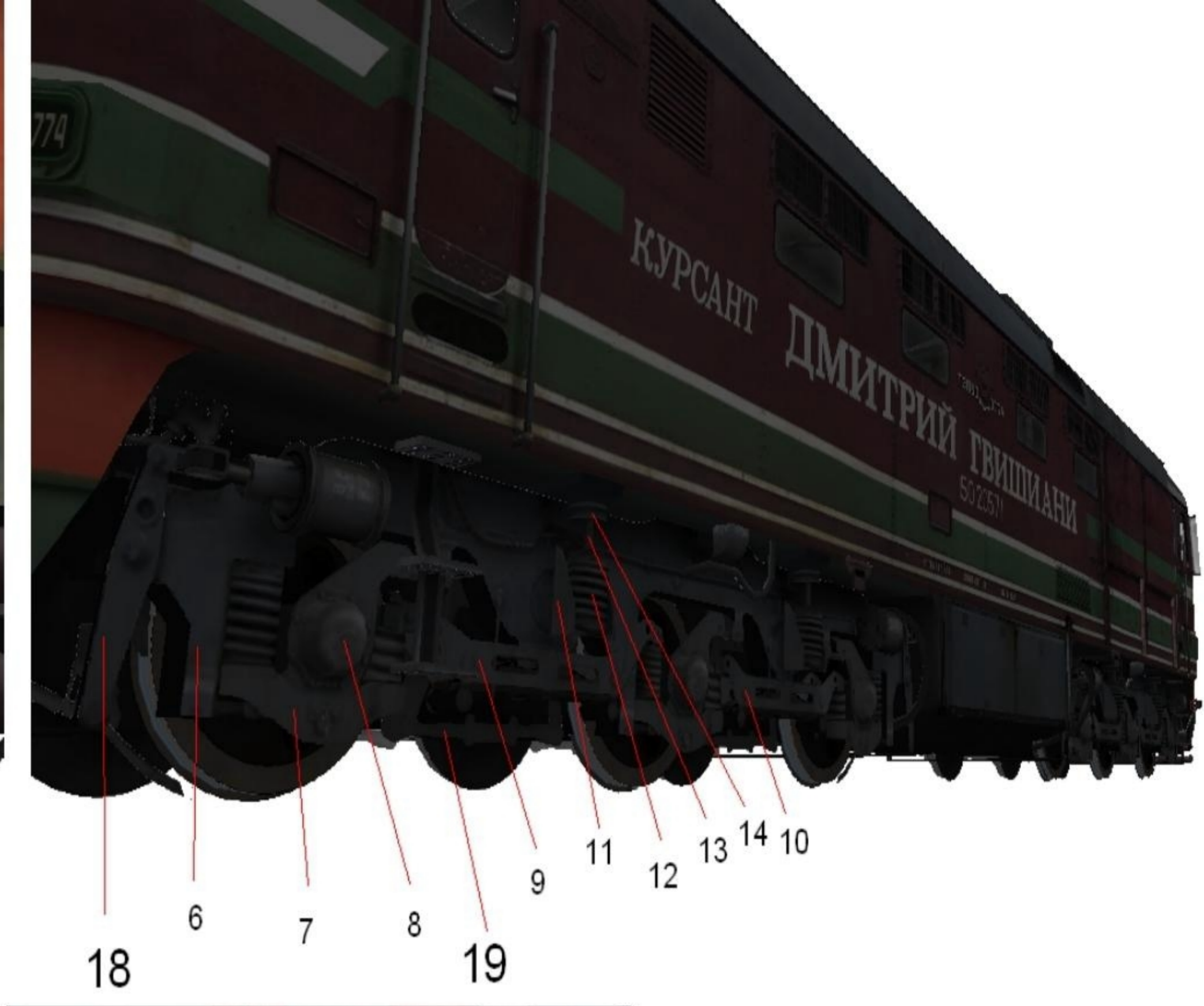
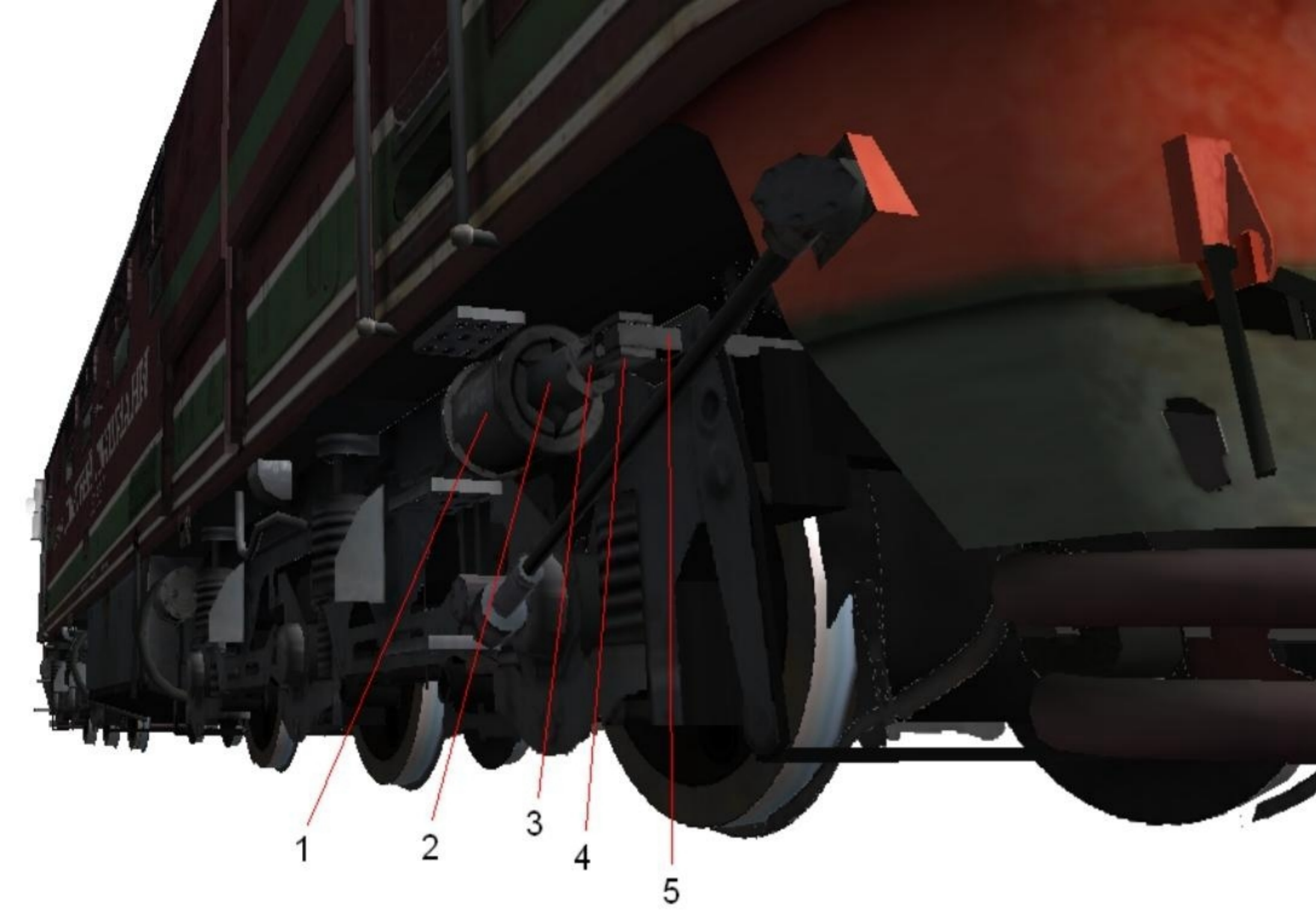

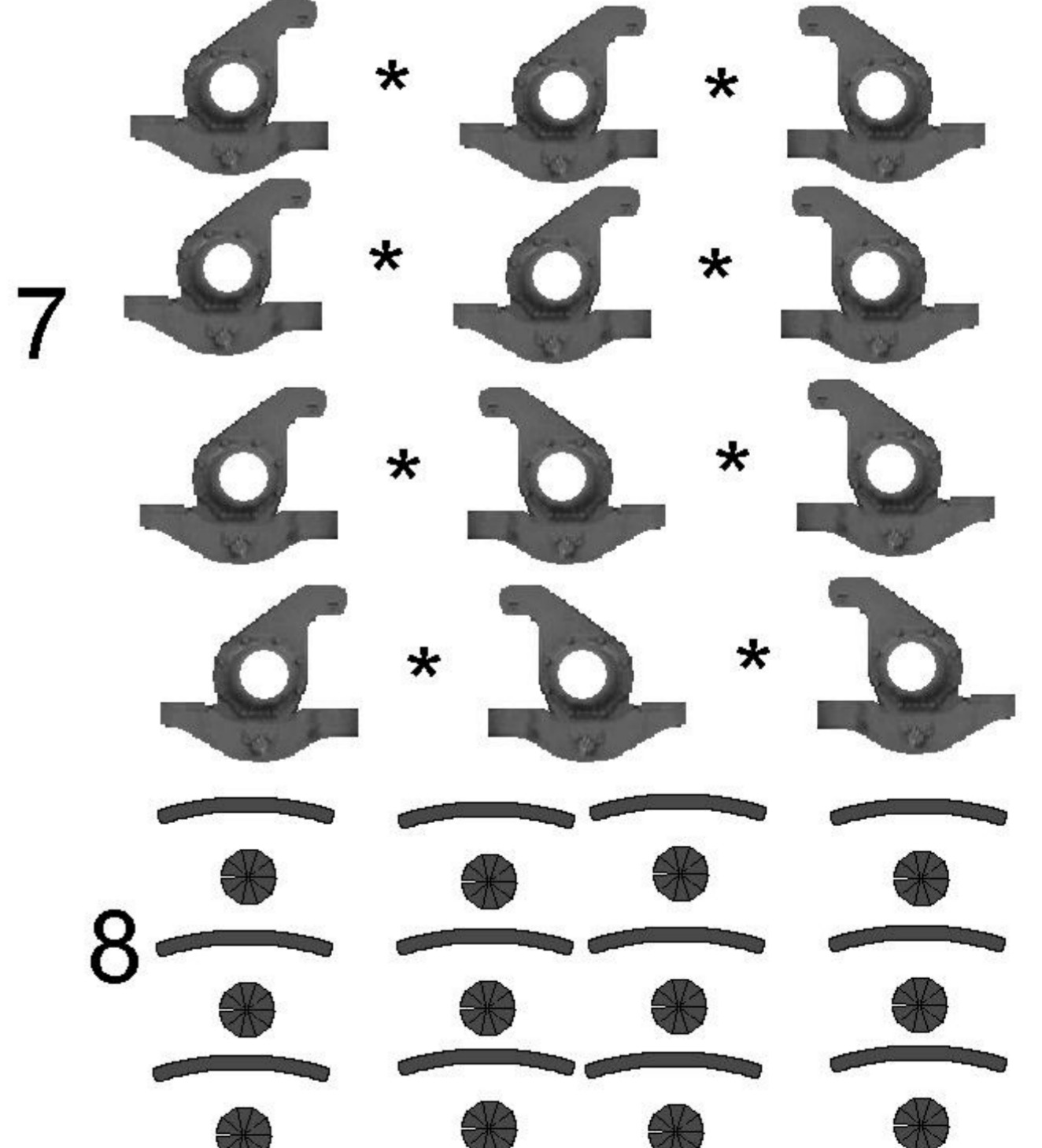
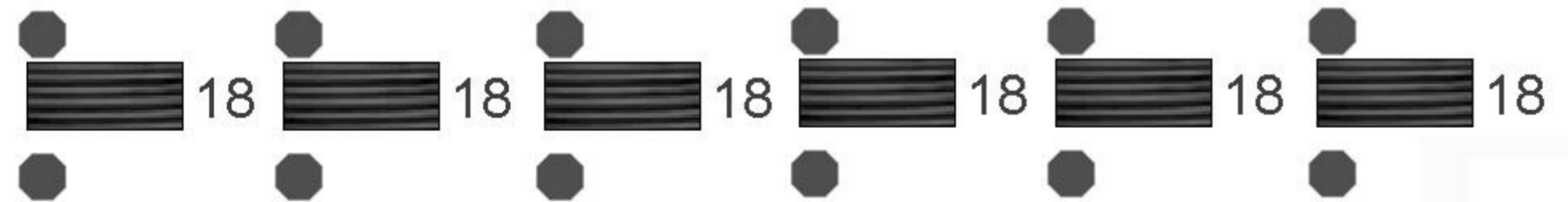
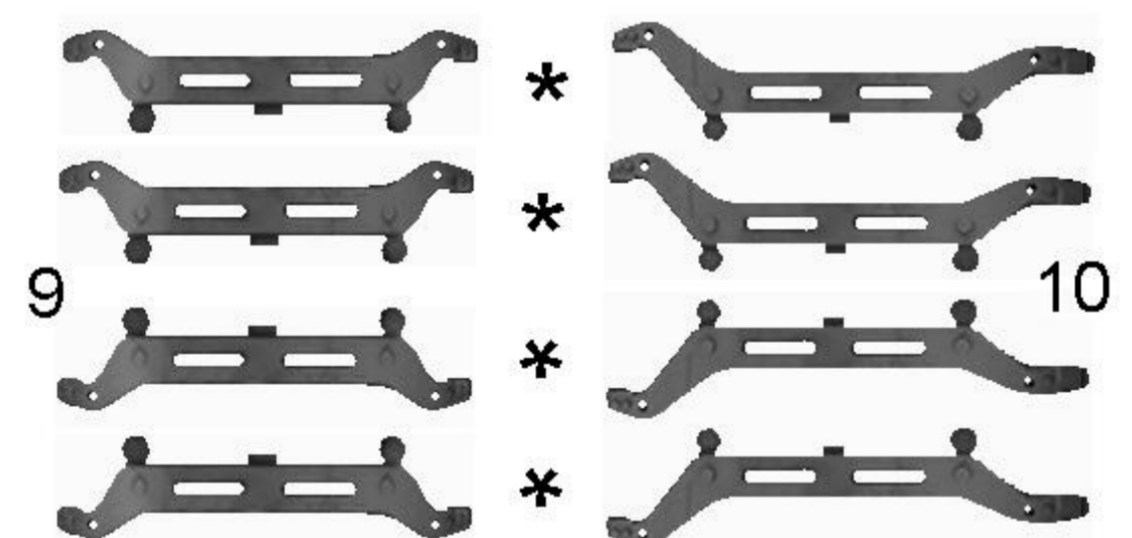
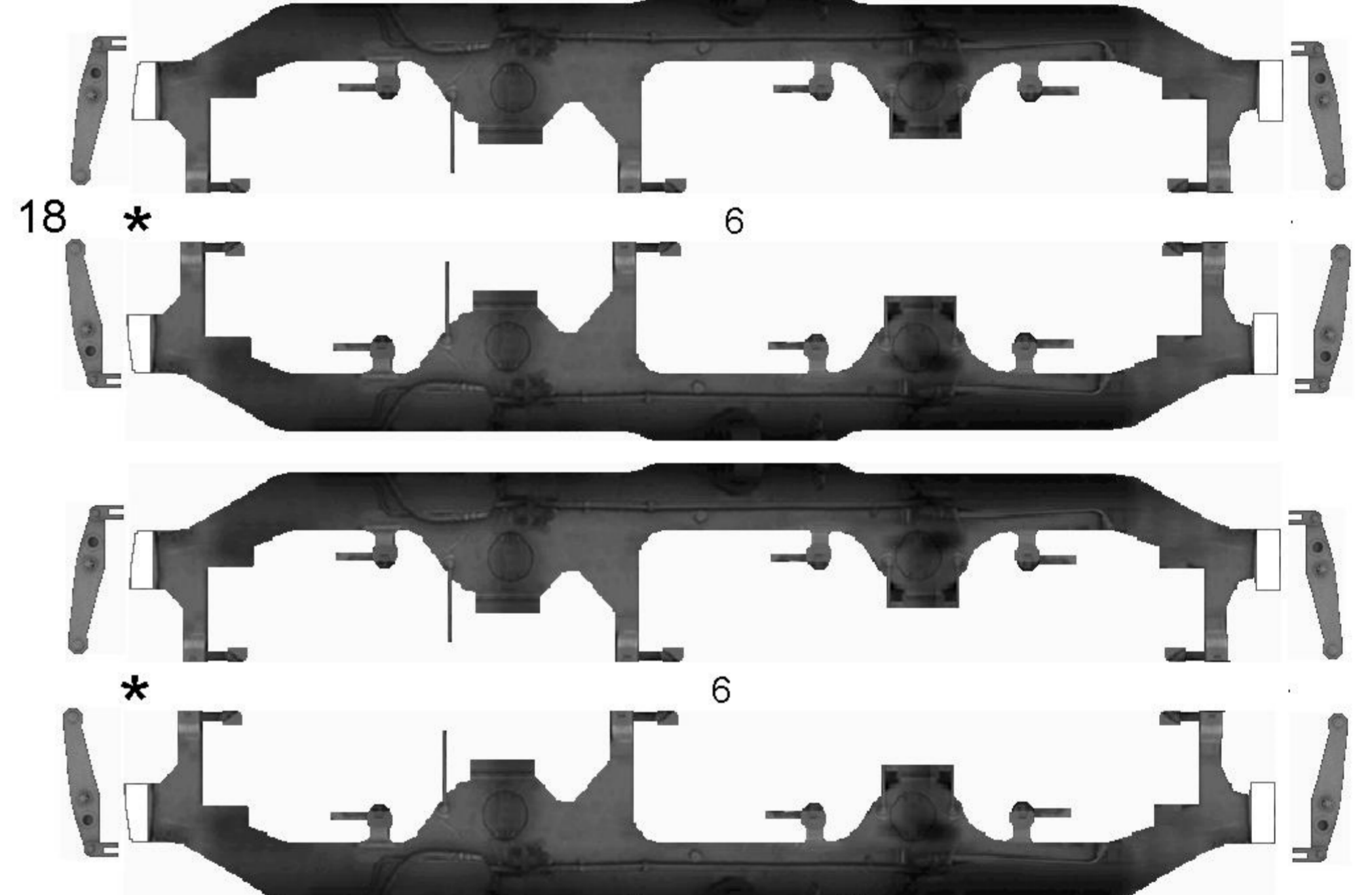
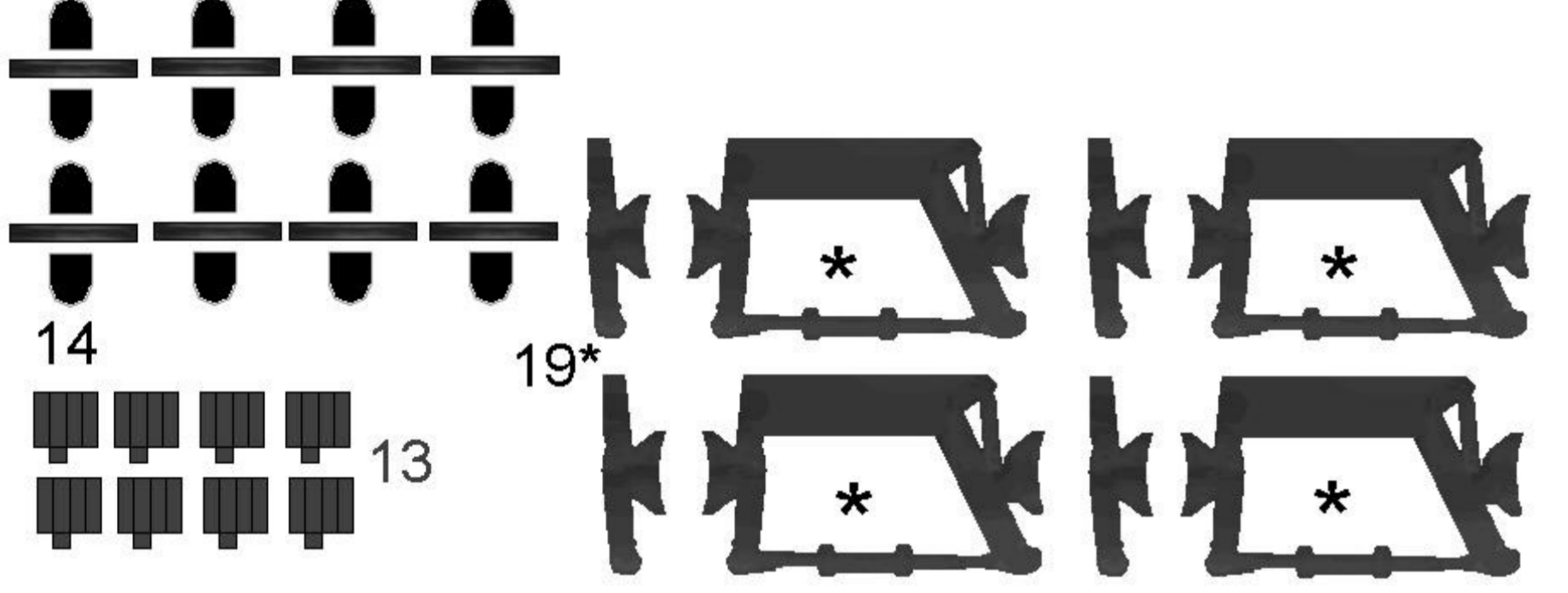
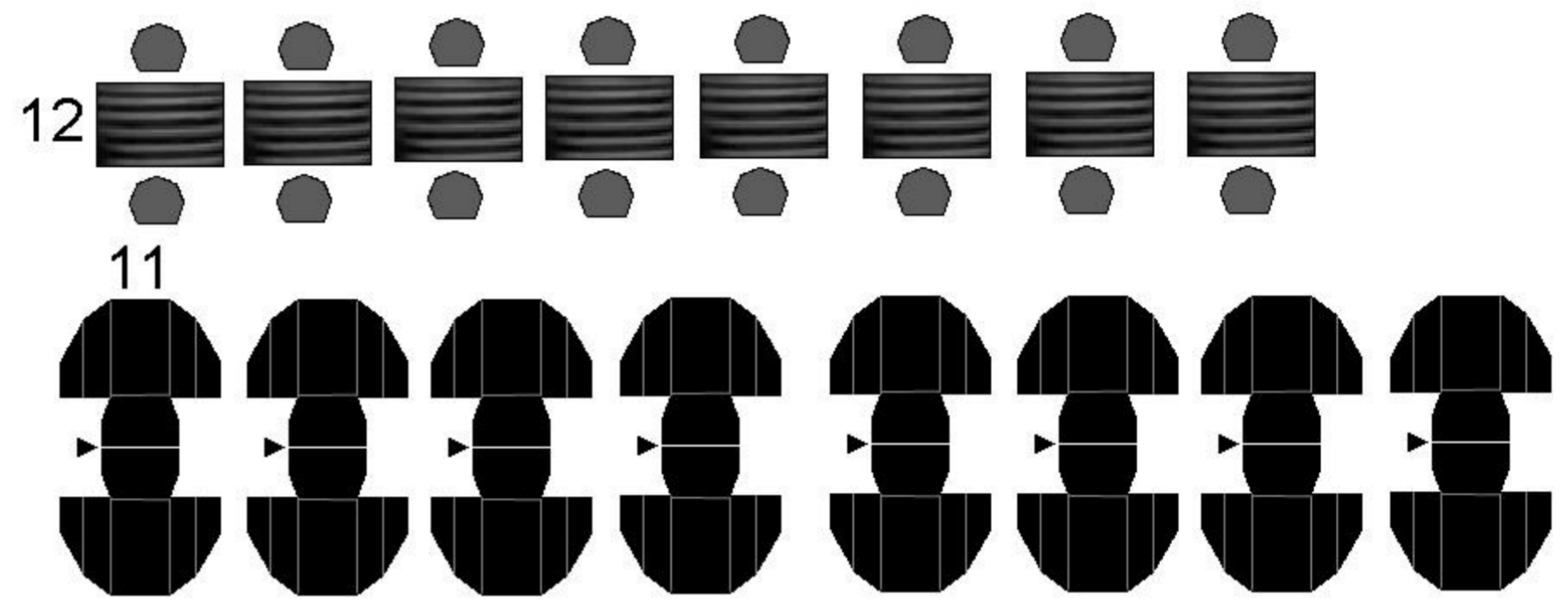
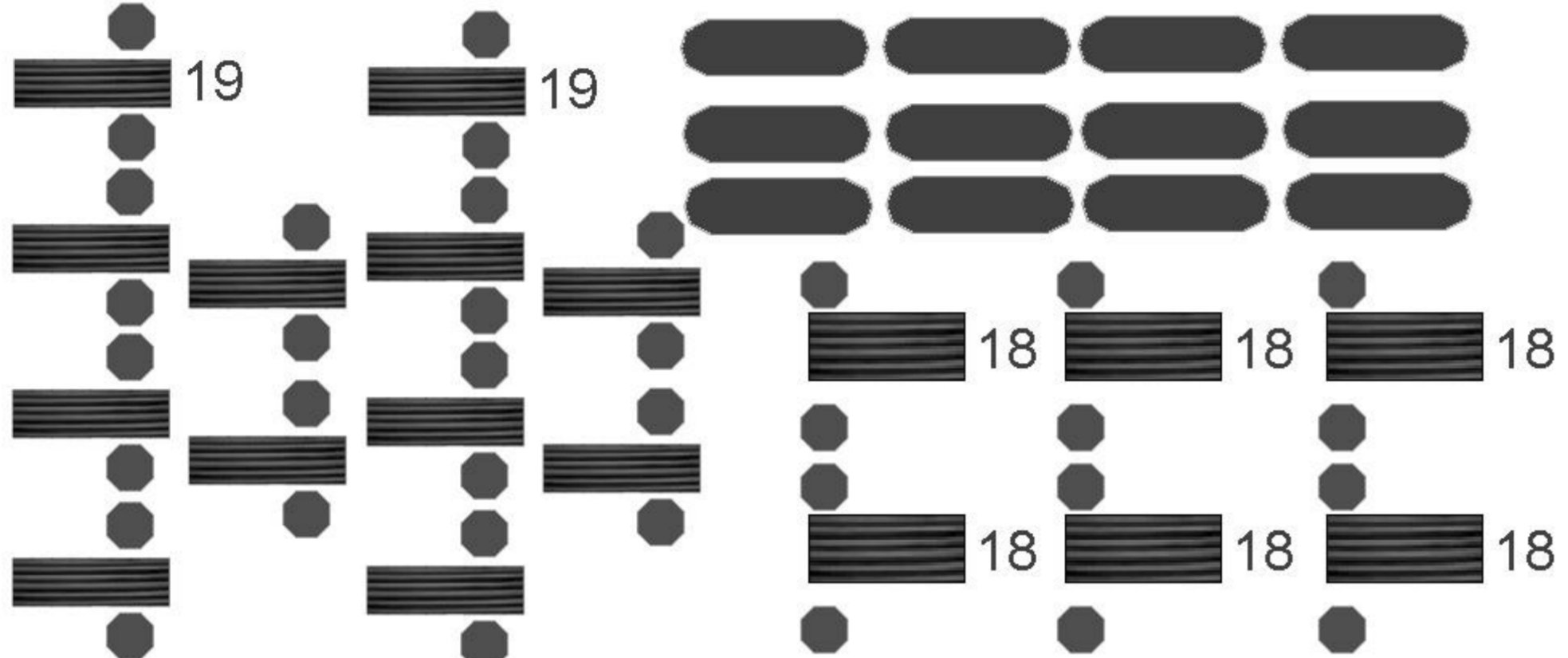
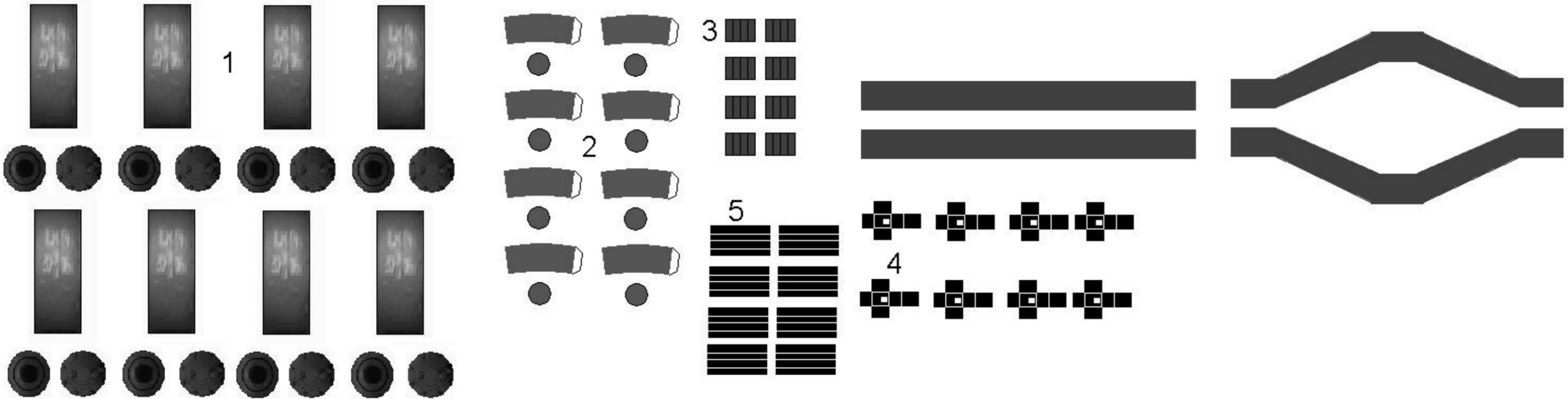
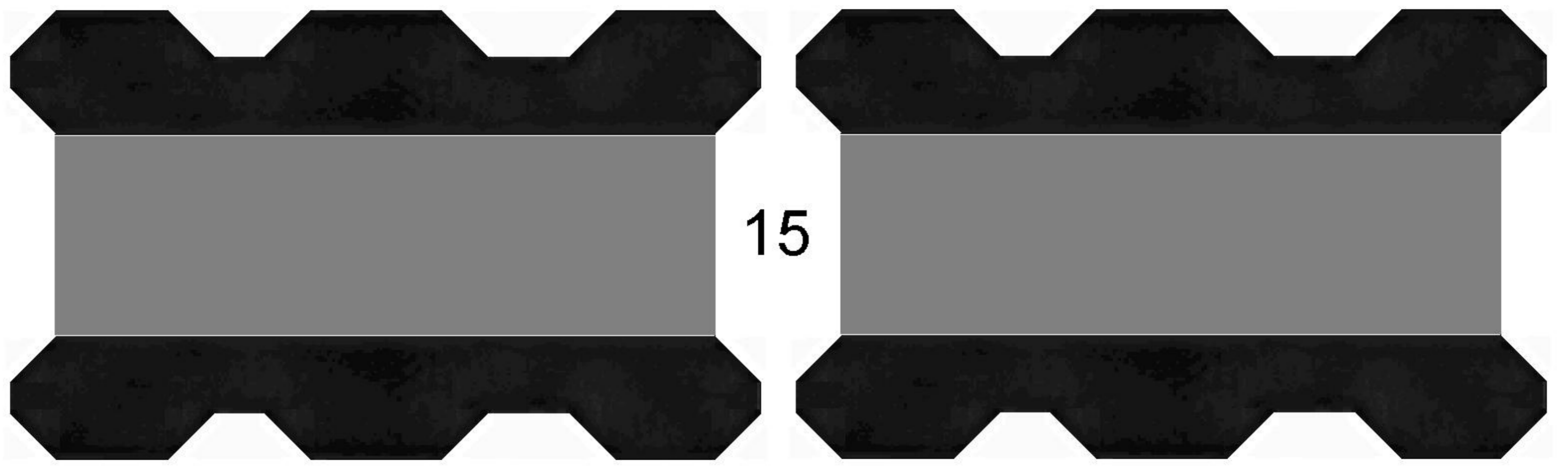

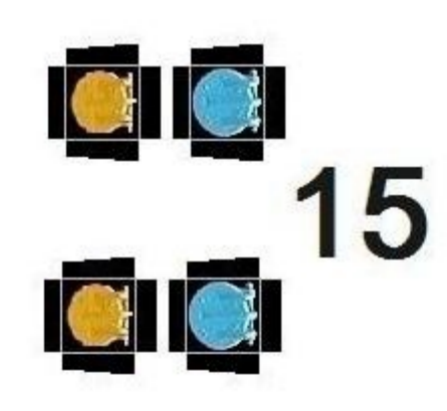
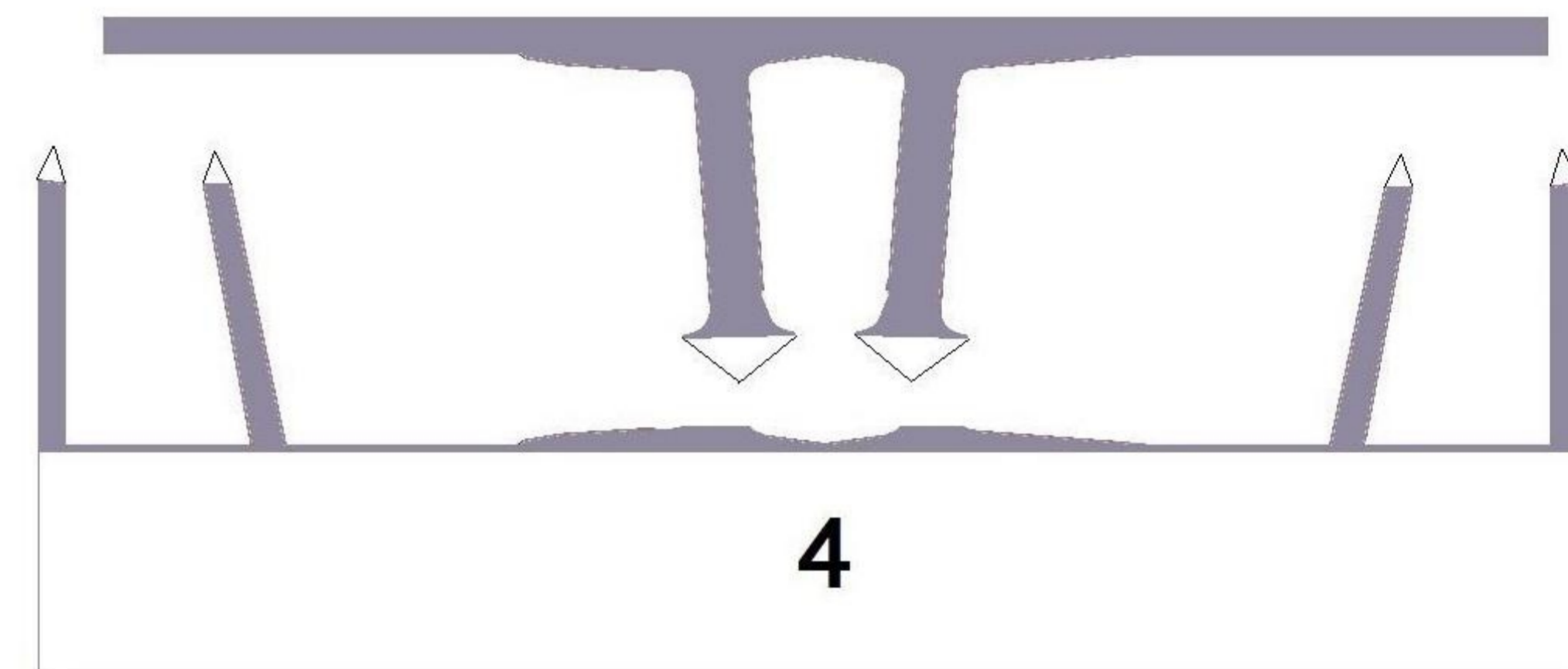
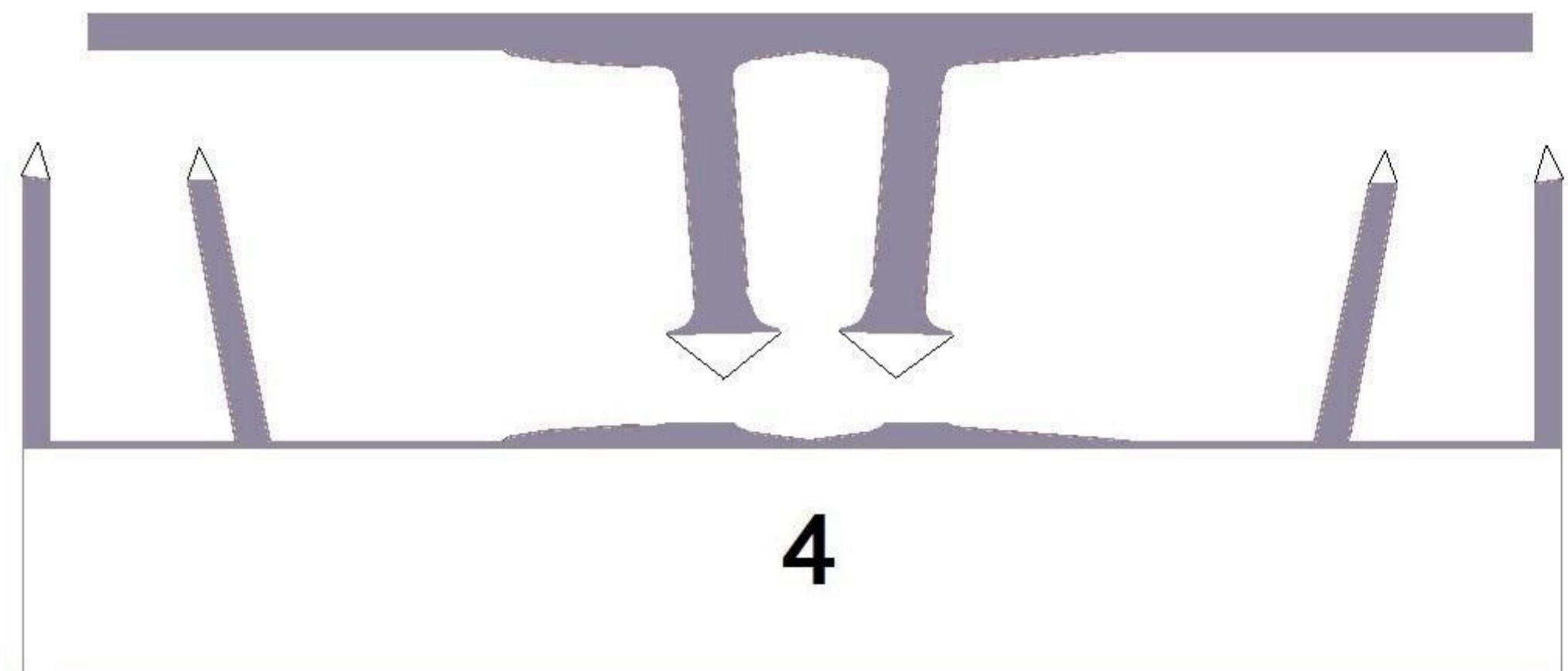
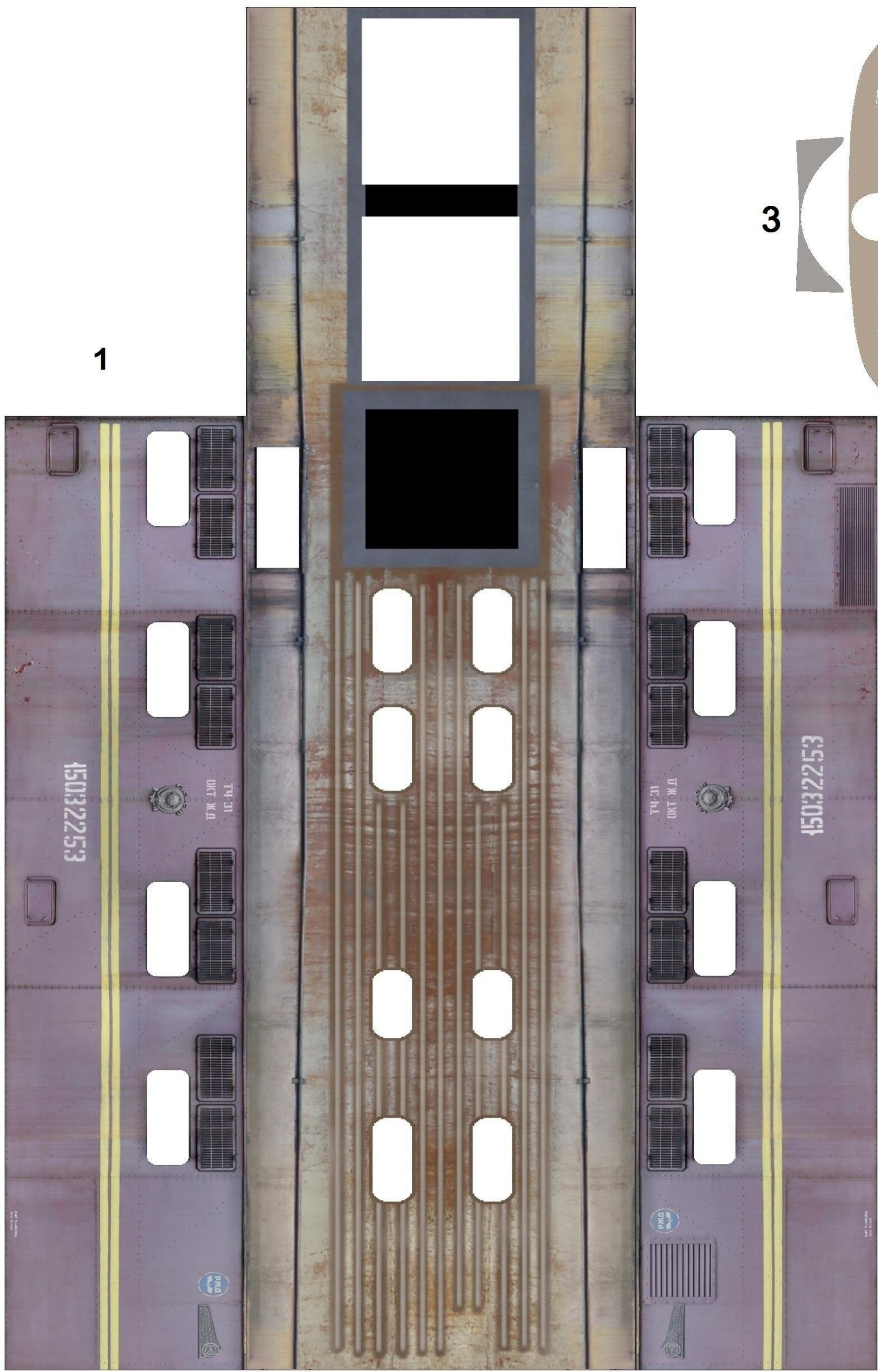

12

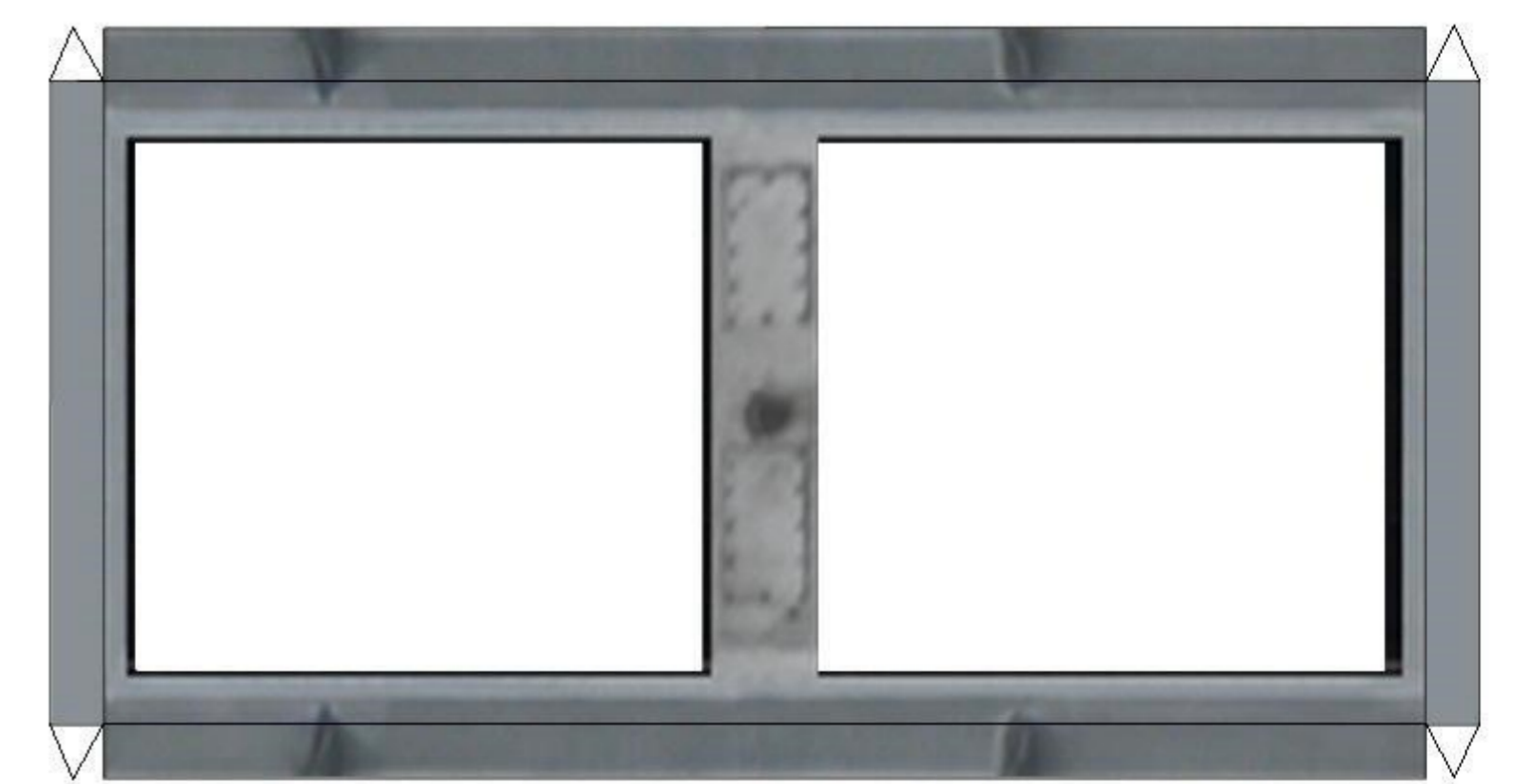

11

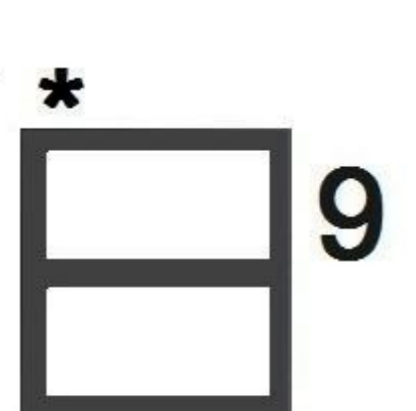
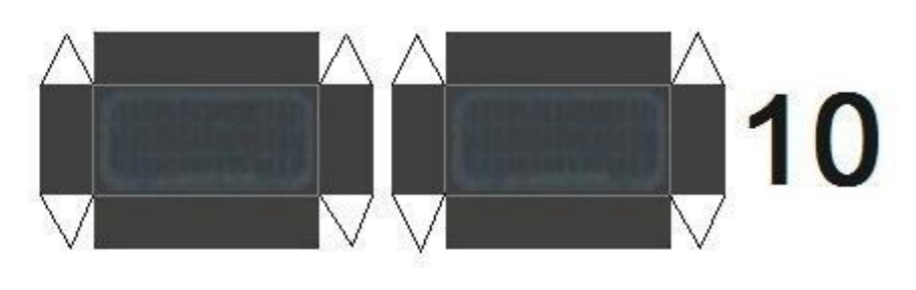
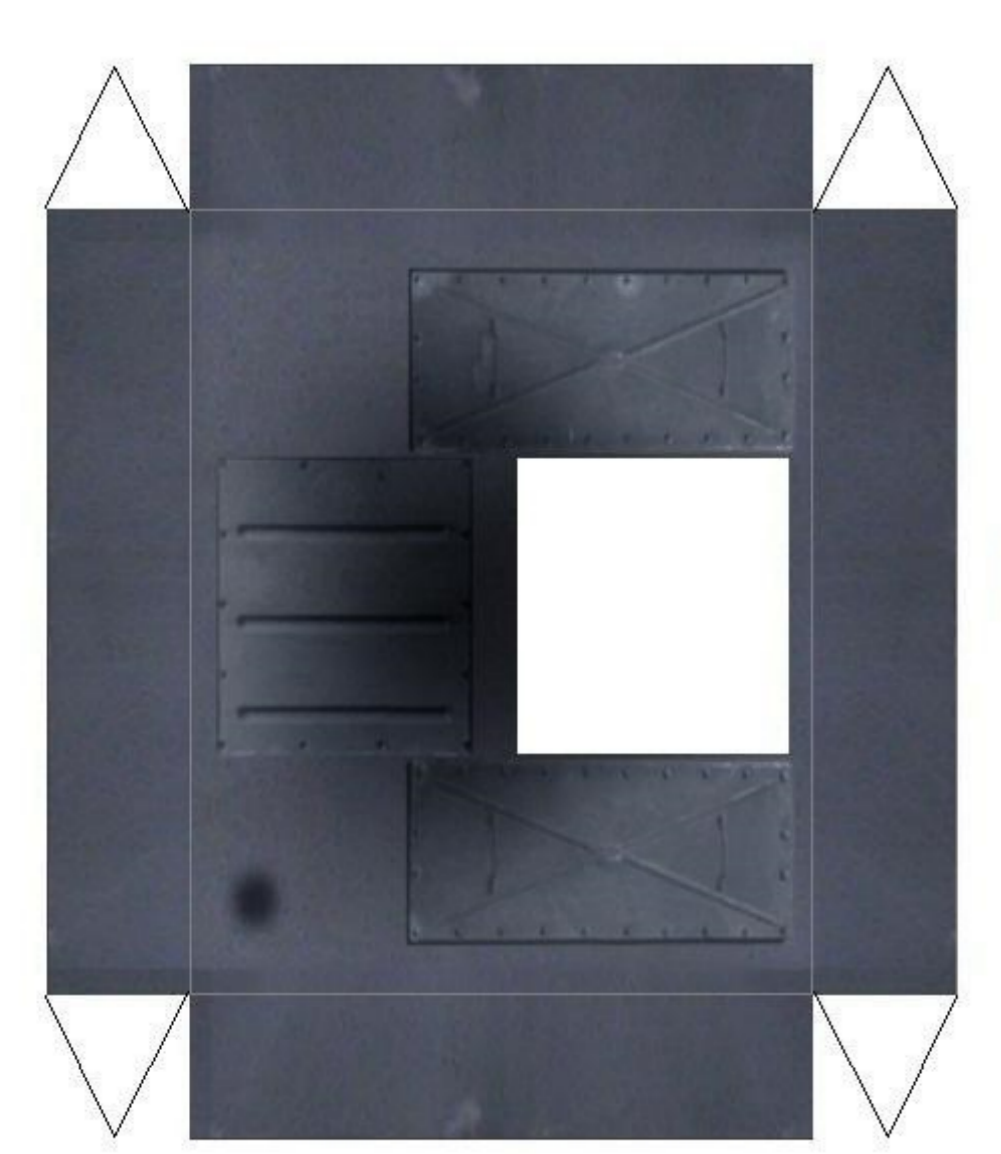
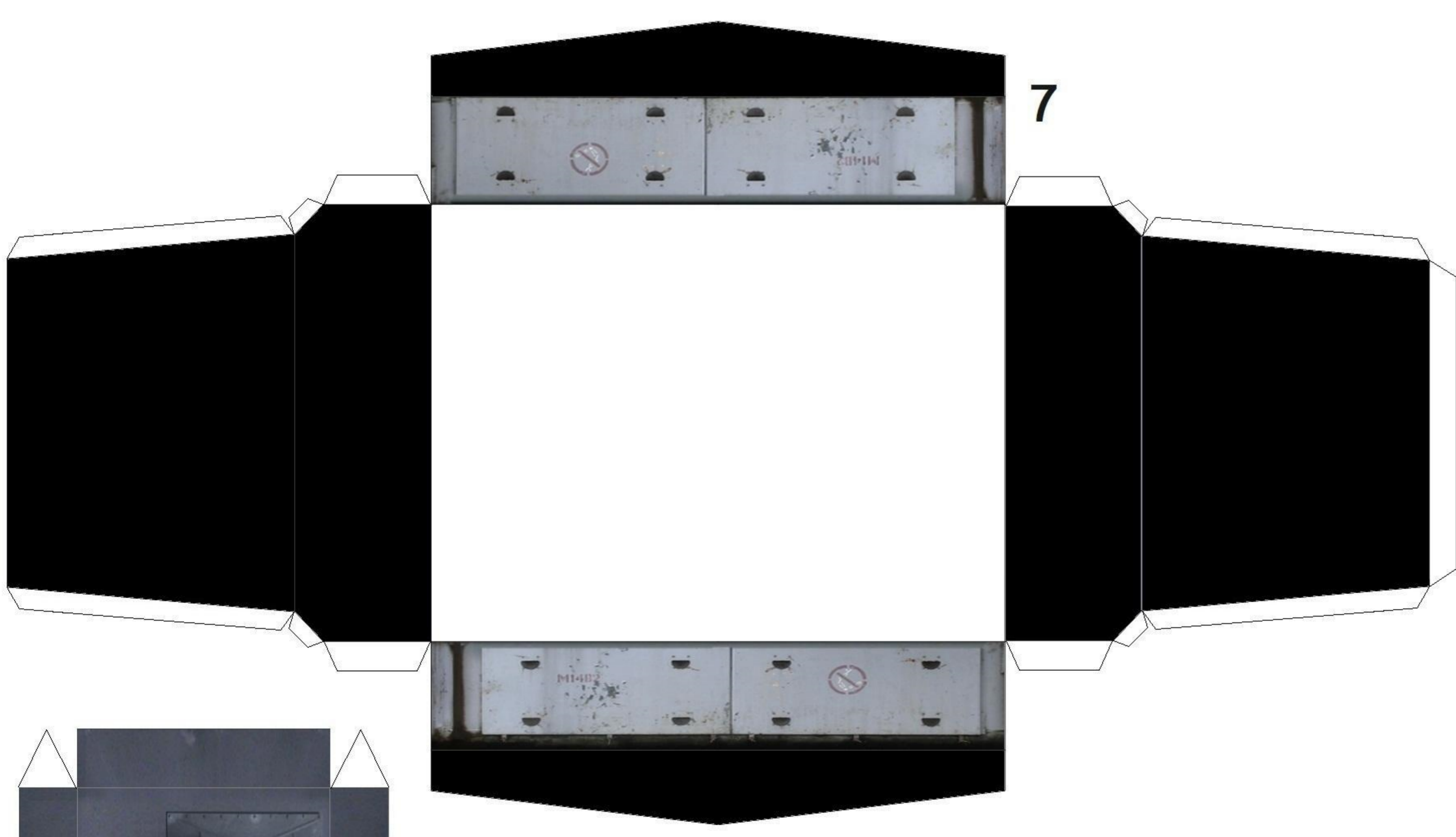

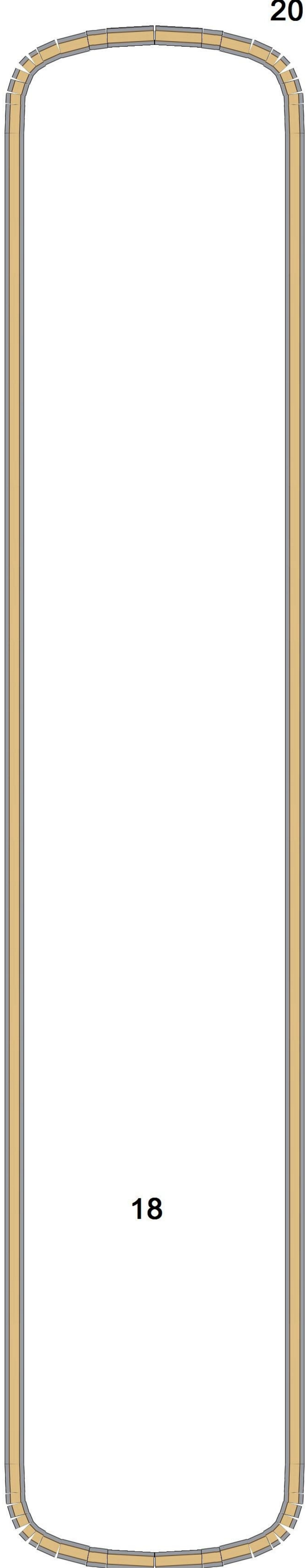

20

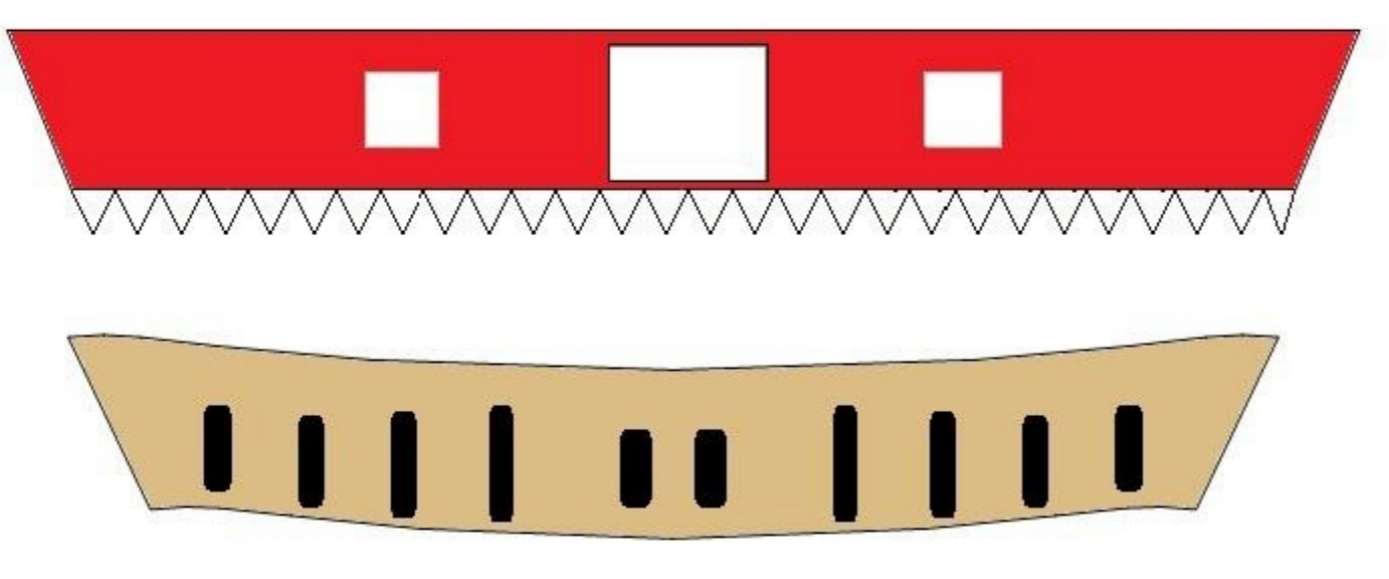
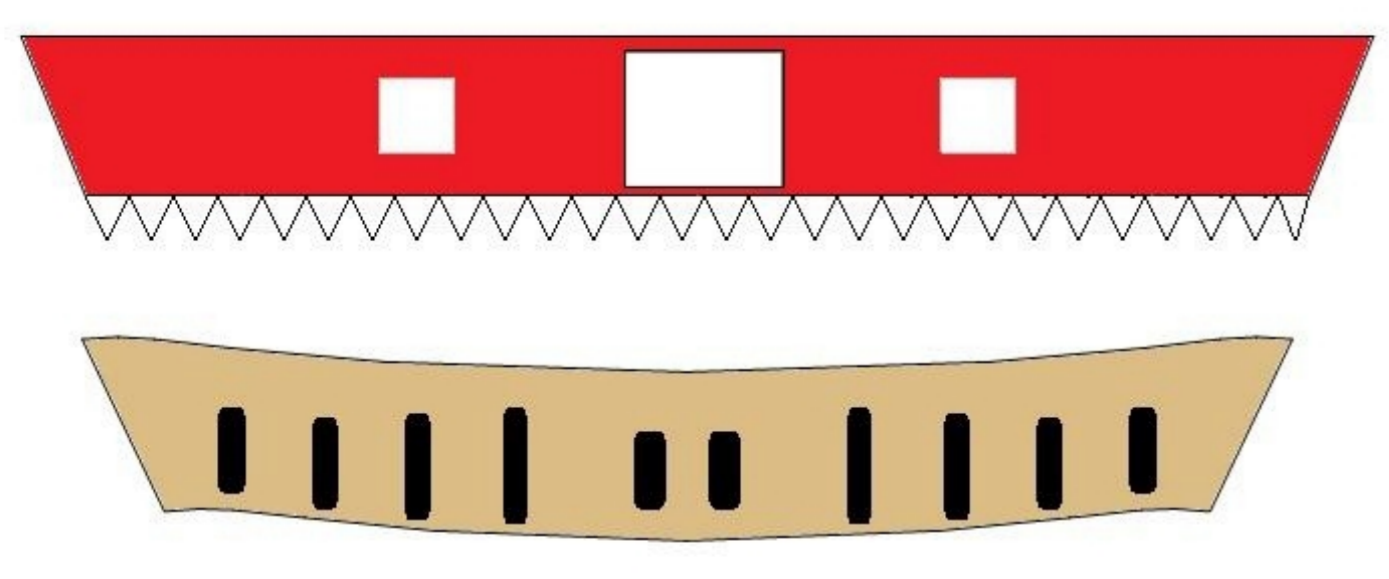
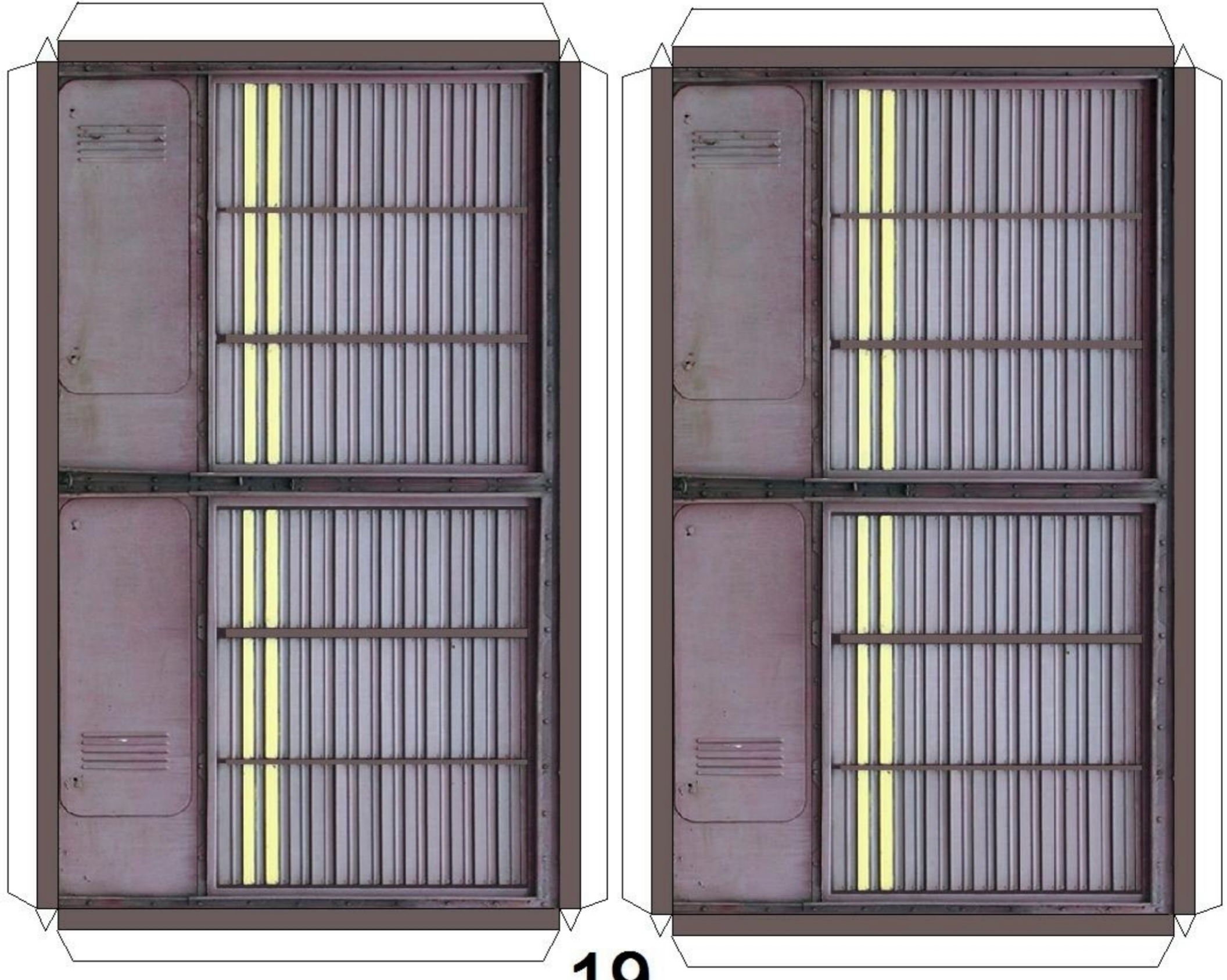
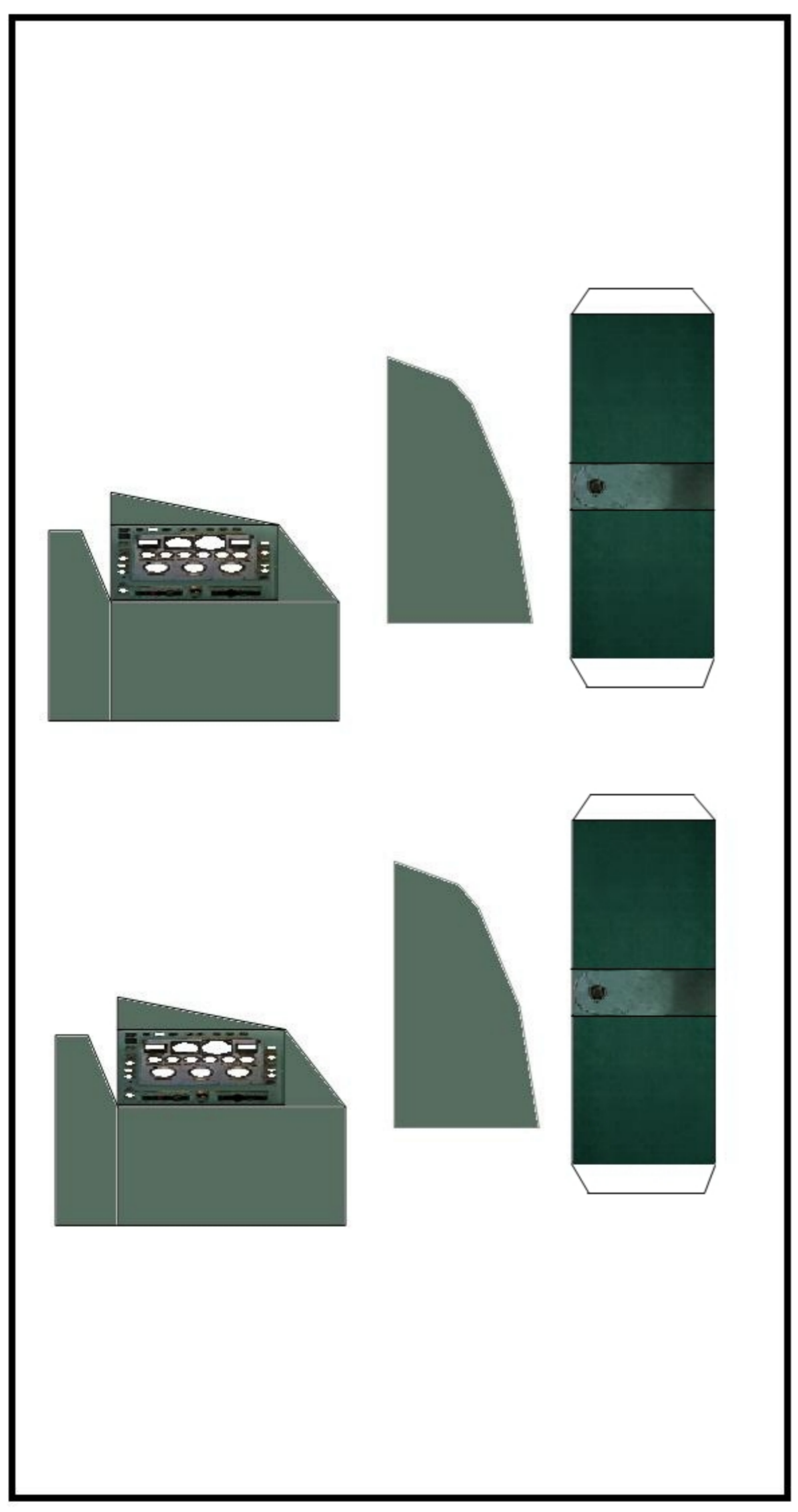
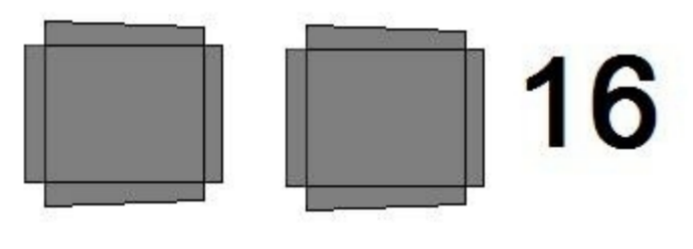
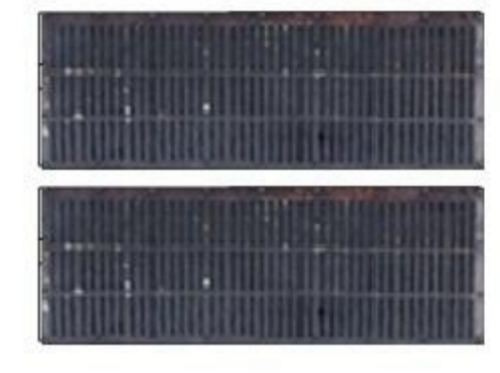
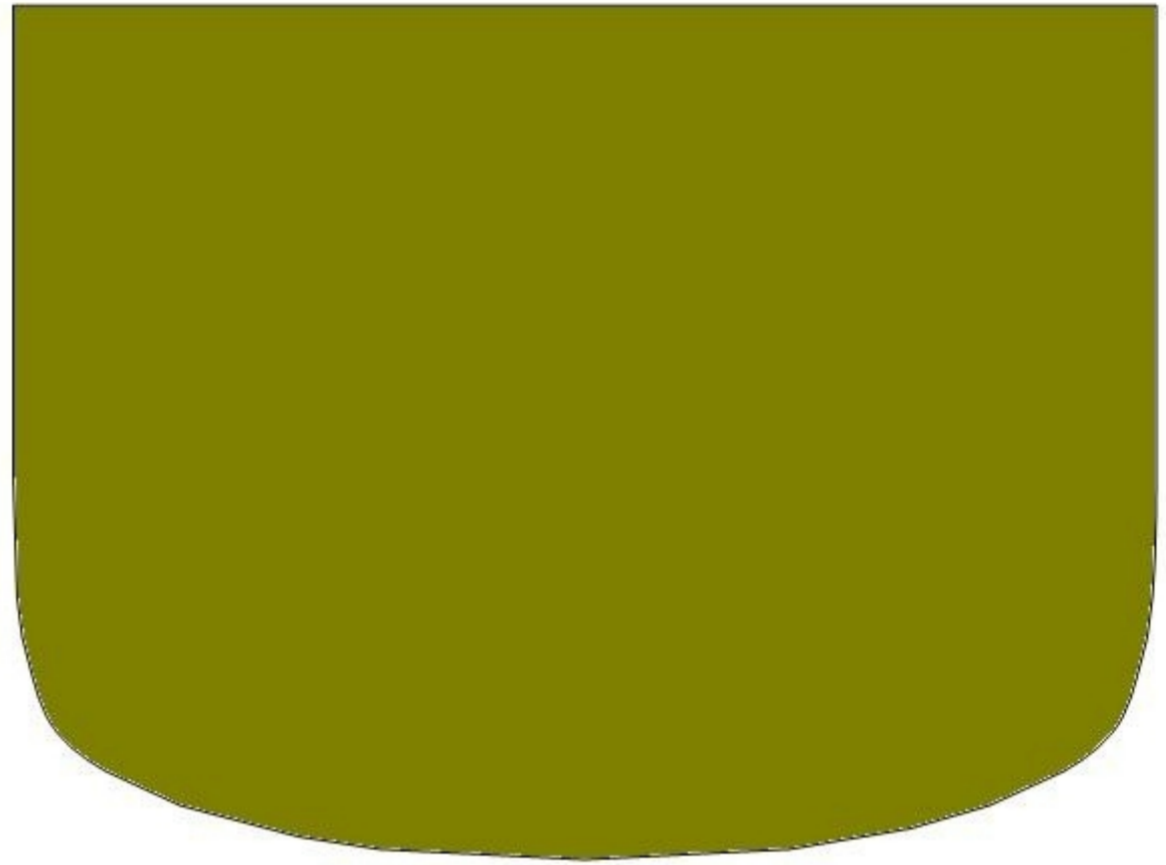
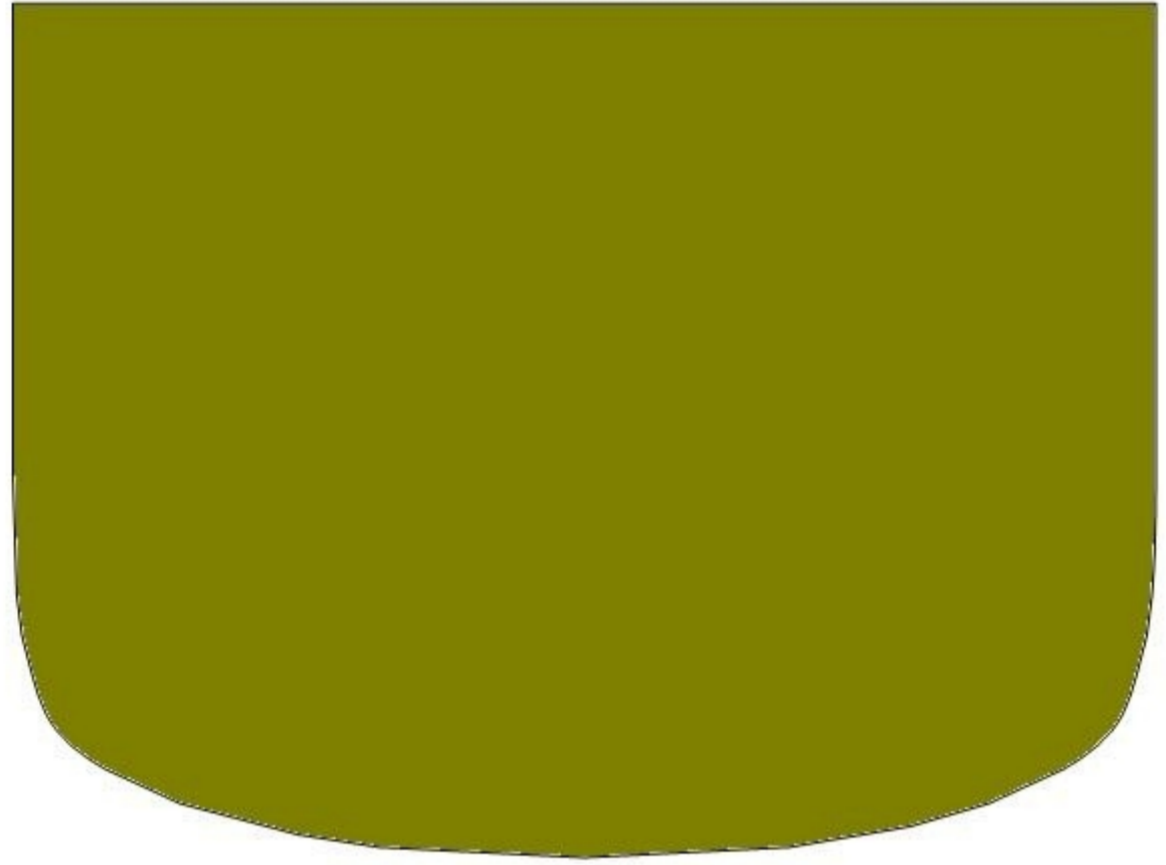
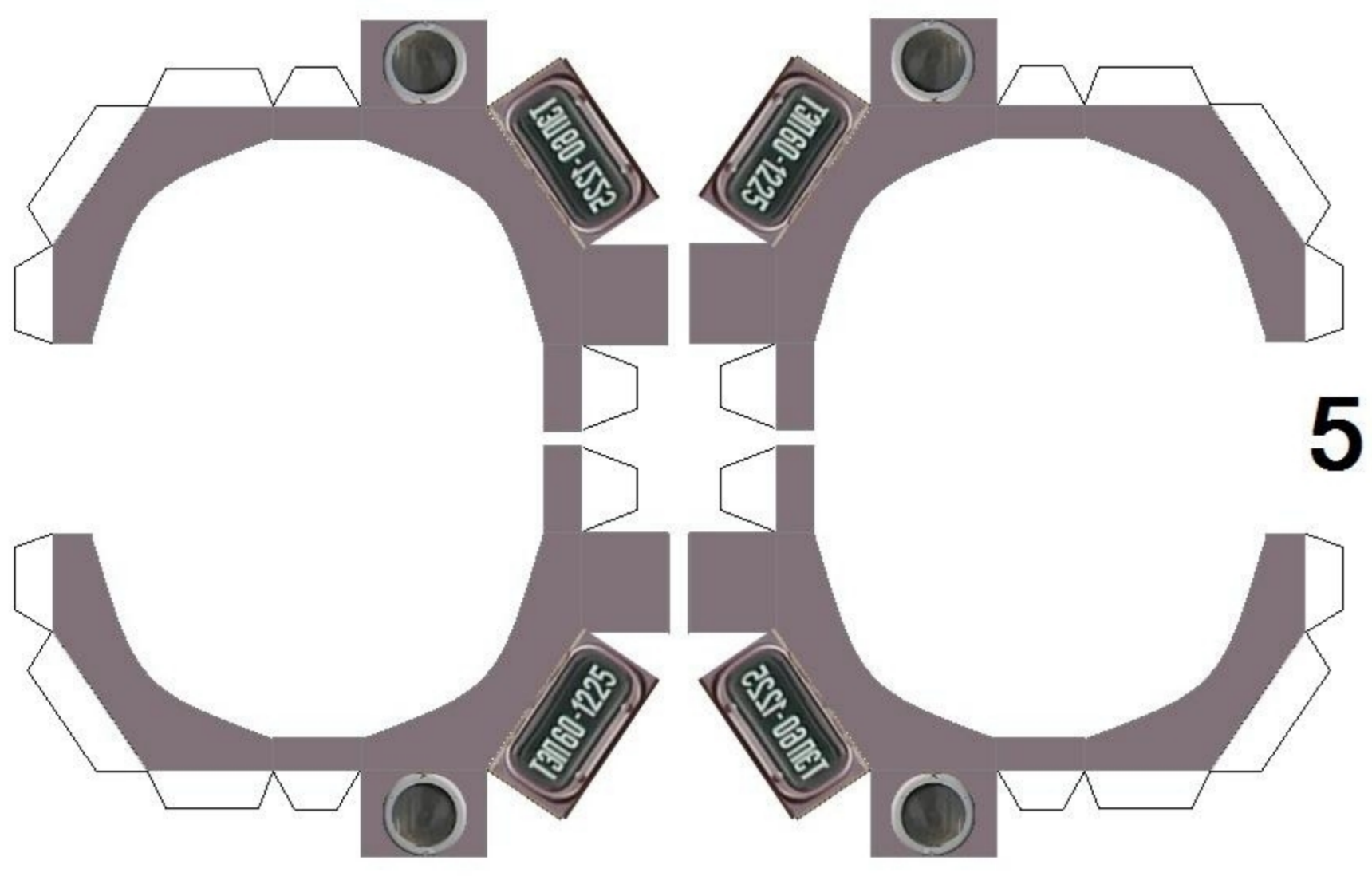
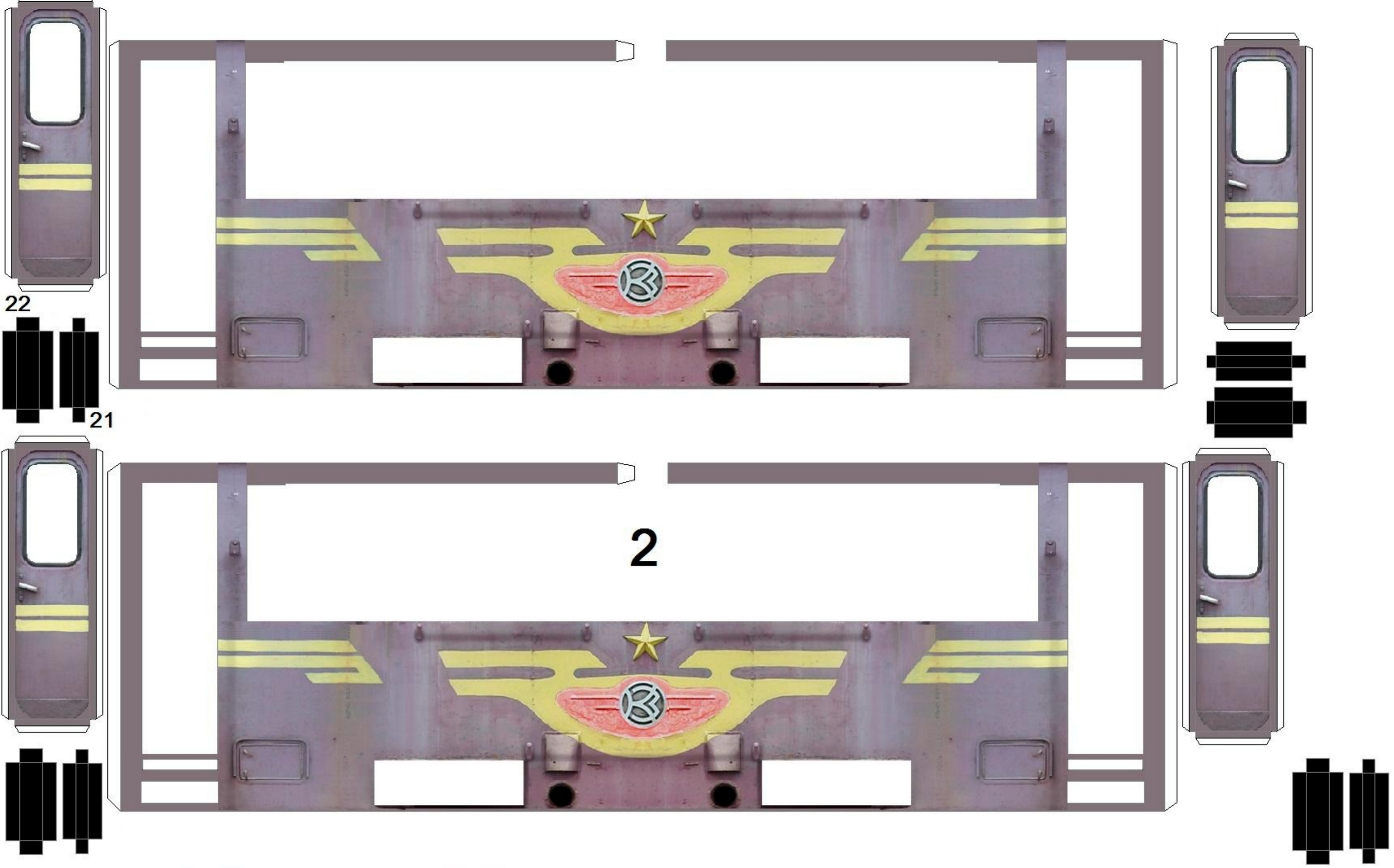

13

14