

3* (подклеить под дет.1)

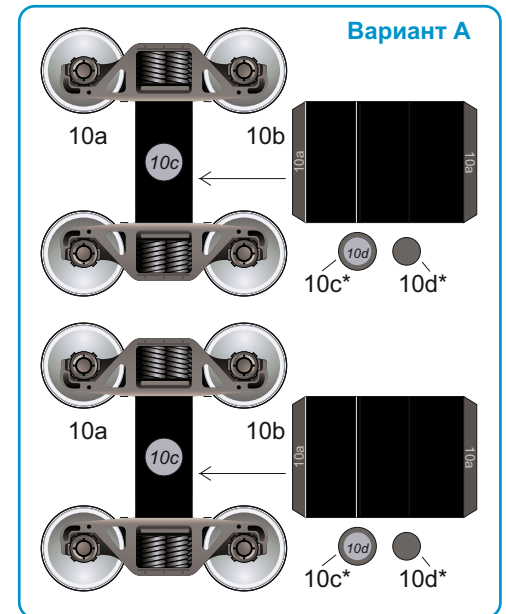

10e - ось колесной пары

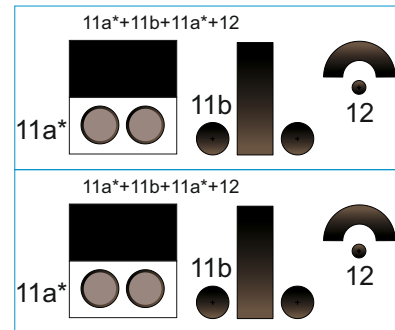

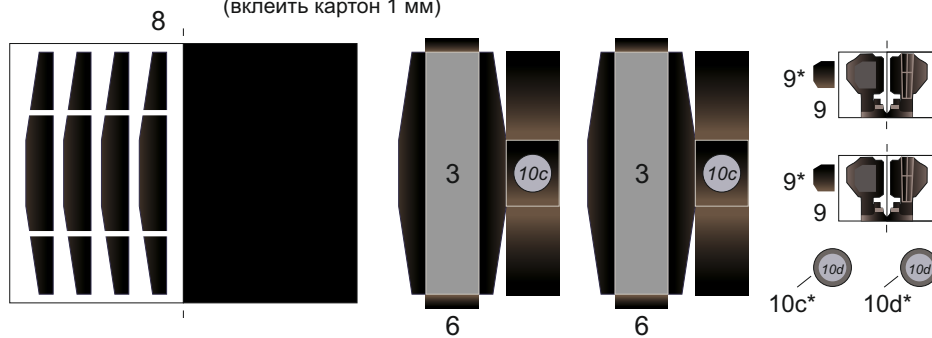
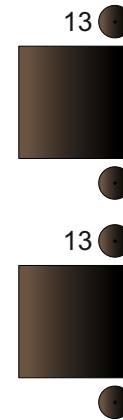
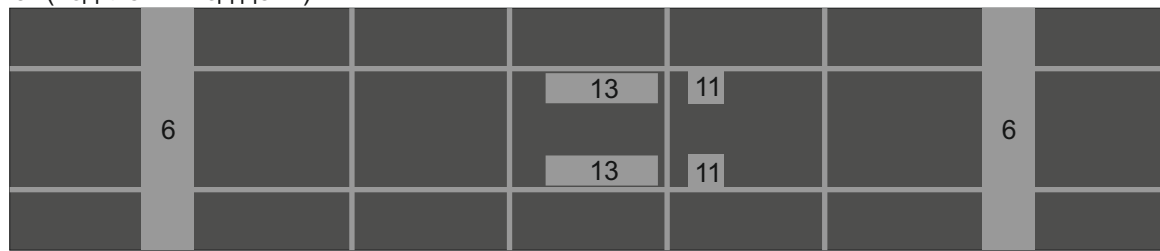
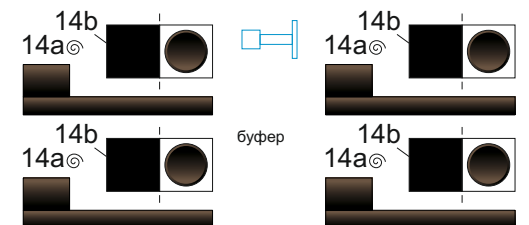
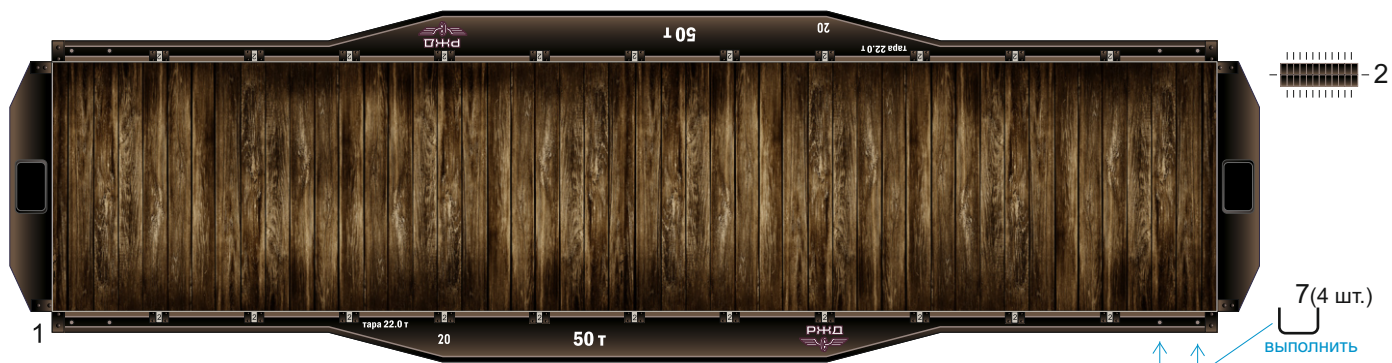

3* (подклеить под дет.1)

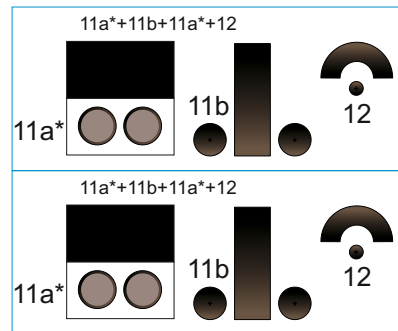
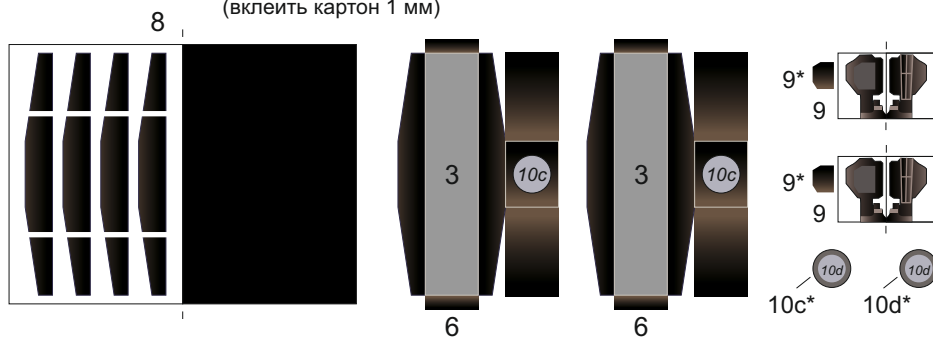
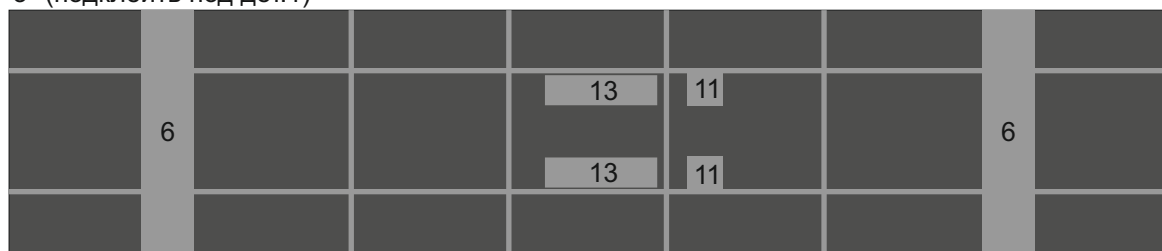

Вариант Б

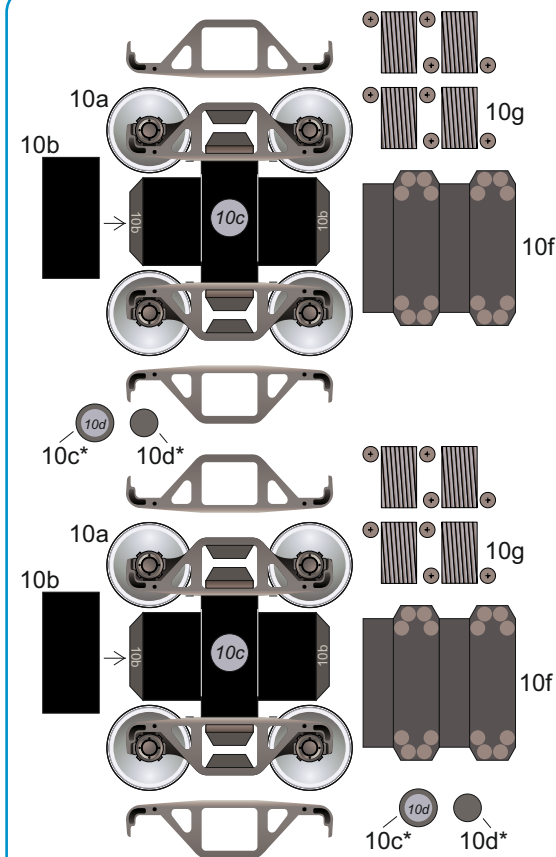

оси 10 е скрутить самостоятельно (разм. 16 x 2,5 мм)

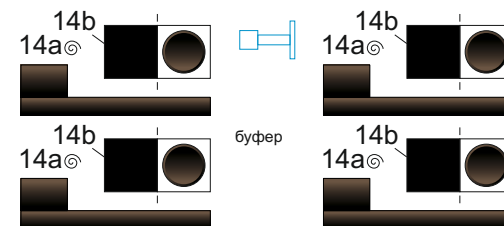
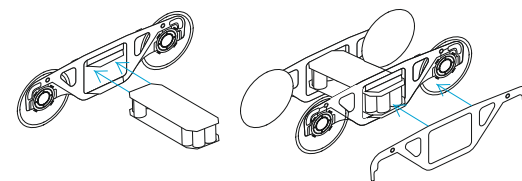

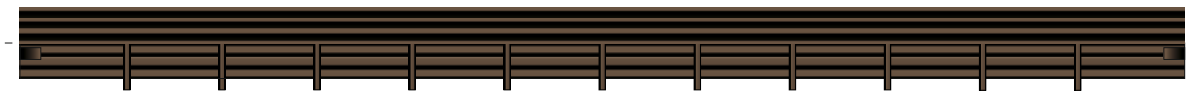
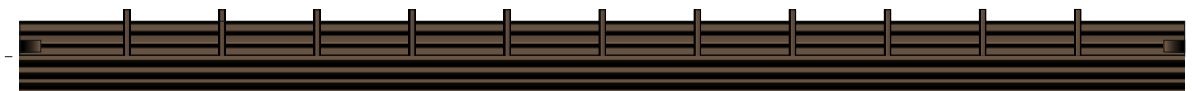

Борта клеить не обязательно,
а если клеить, то убирать
детали №2, а борта клеить
на эти посадочные места.

