

3* (подклеить под дет.1)

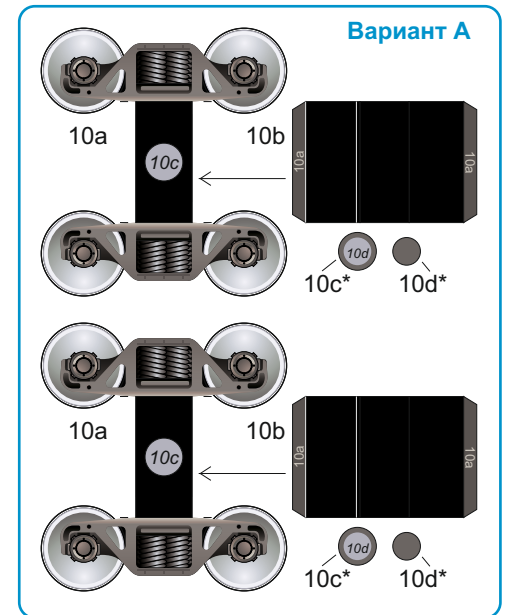

10e - ось колесной пары

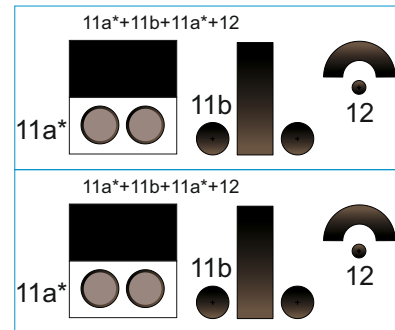

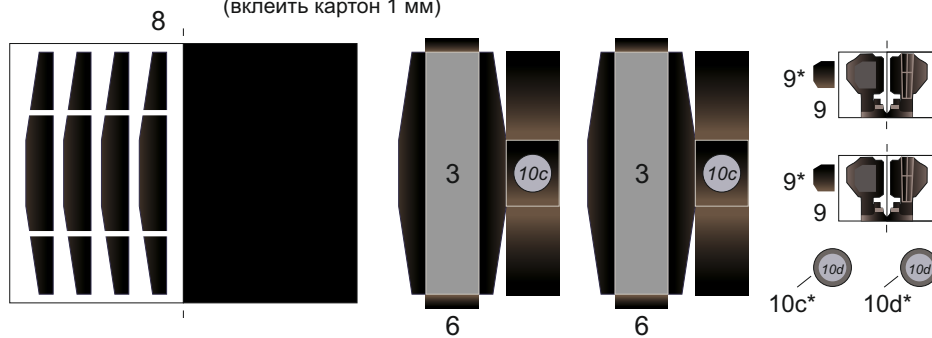
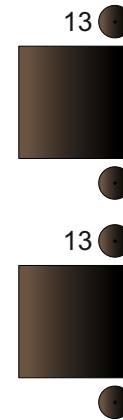
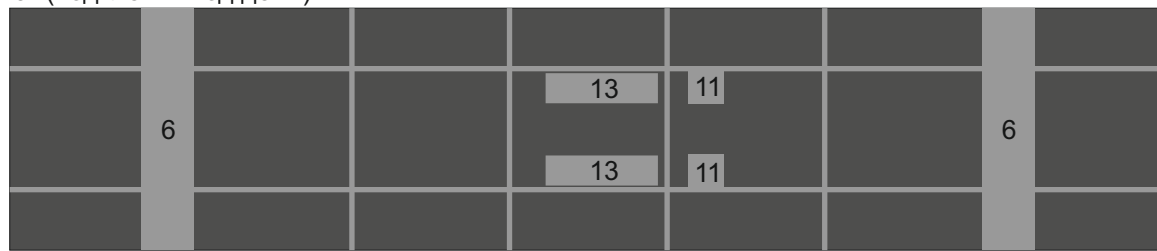
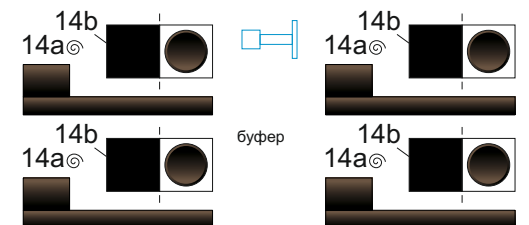
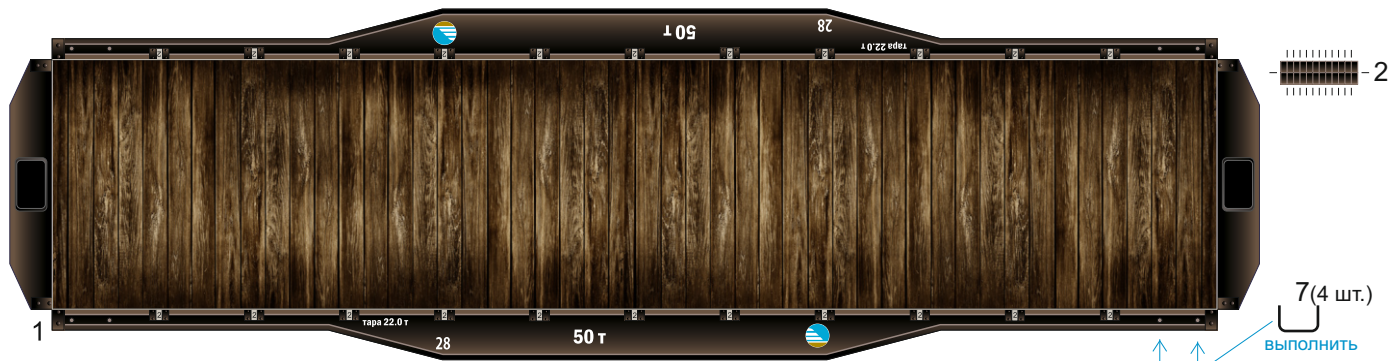

3* (подклеить под дет.1)

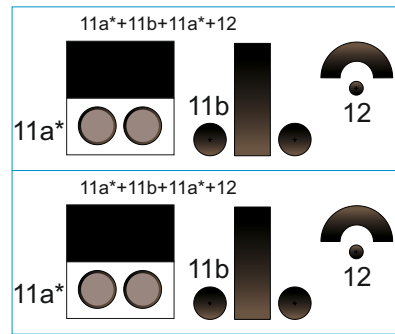
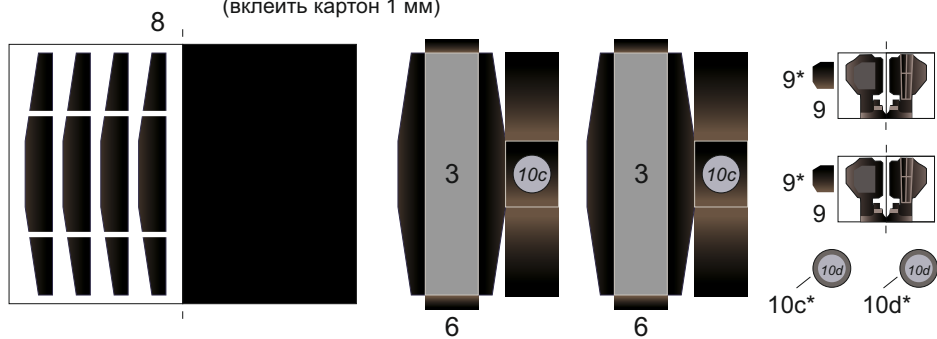
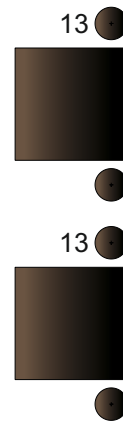
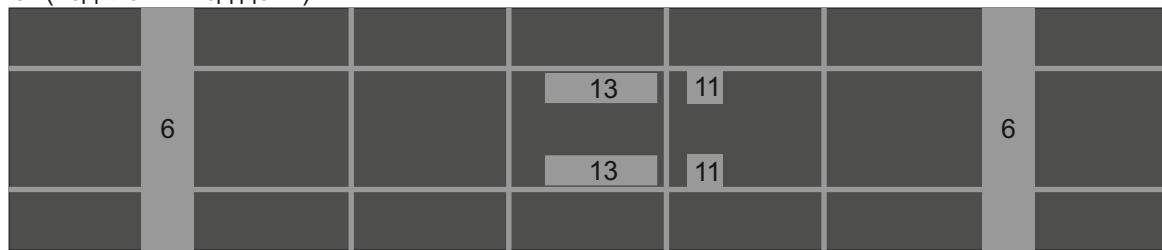

Вариант Б

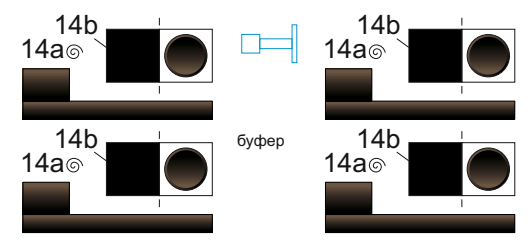
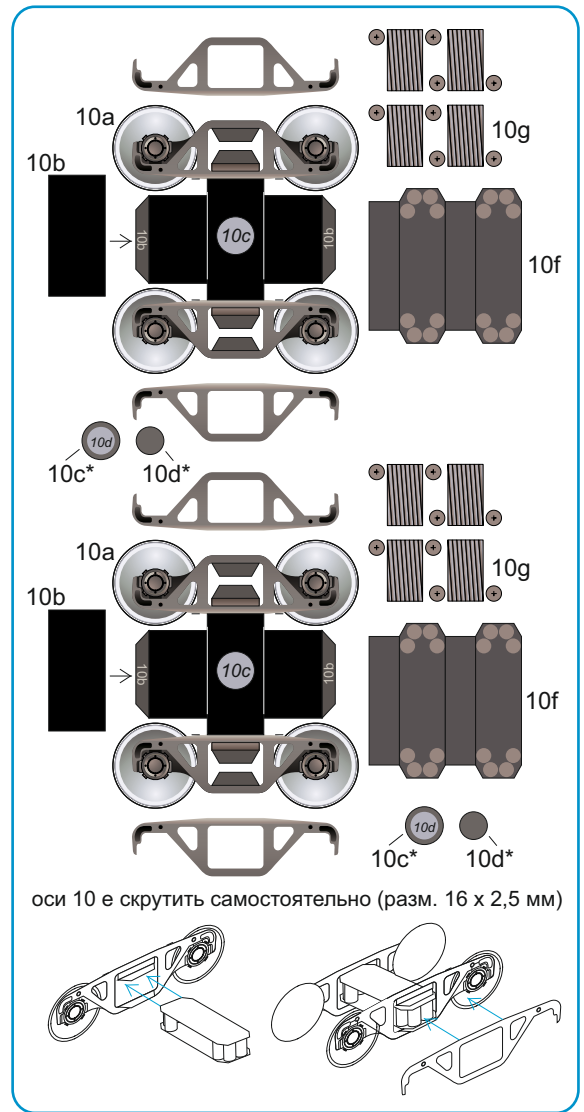

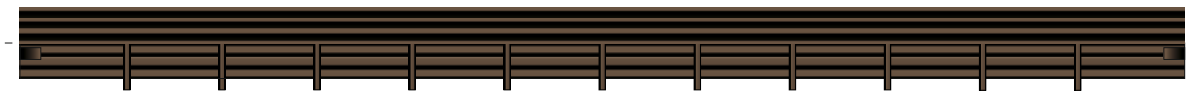
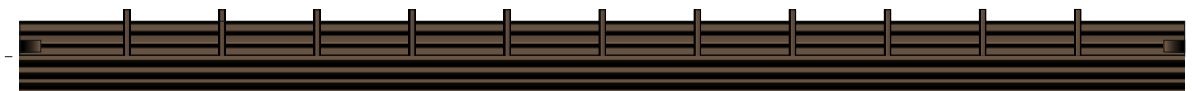

Борта клеить не обязательно,
а если клеить, то убирать
детали №2, а борта клеить
на эти посадочные места.

