

3* (подклеить под дет.1)

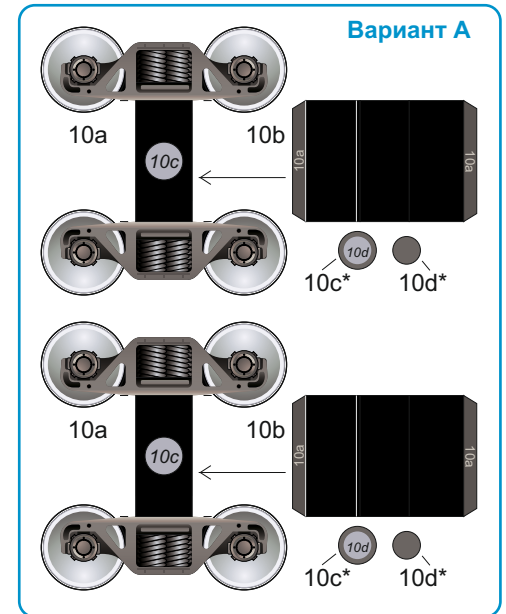

10e - ось колесной пары

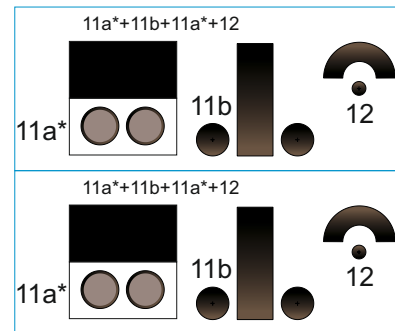

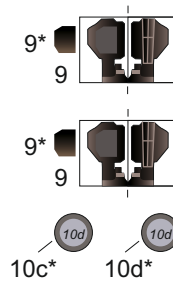
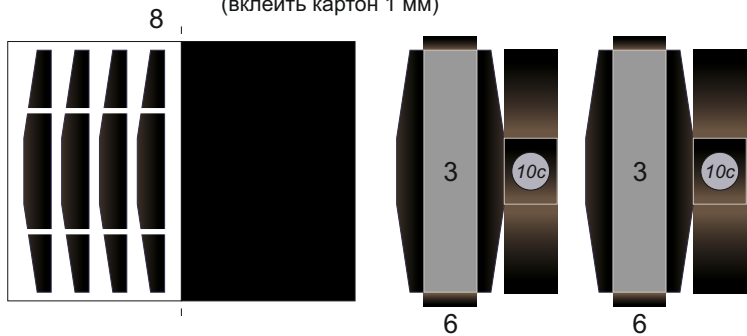
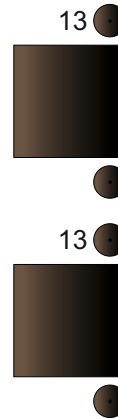
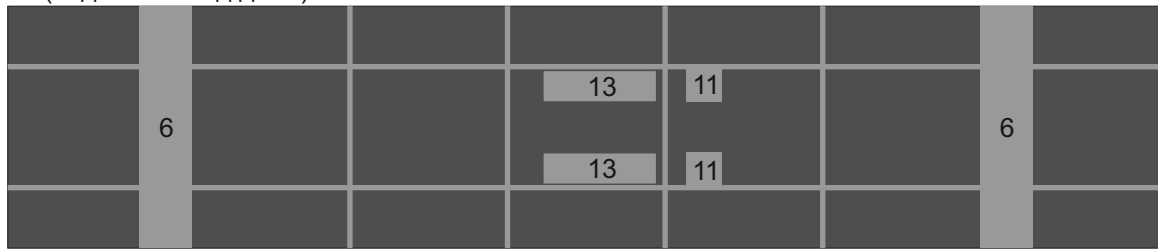
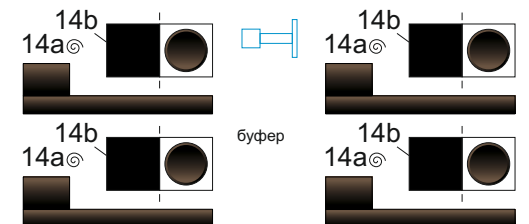
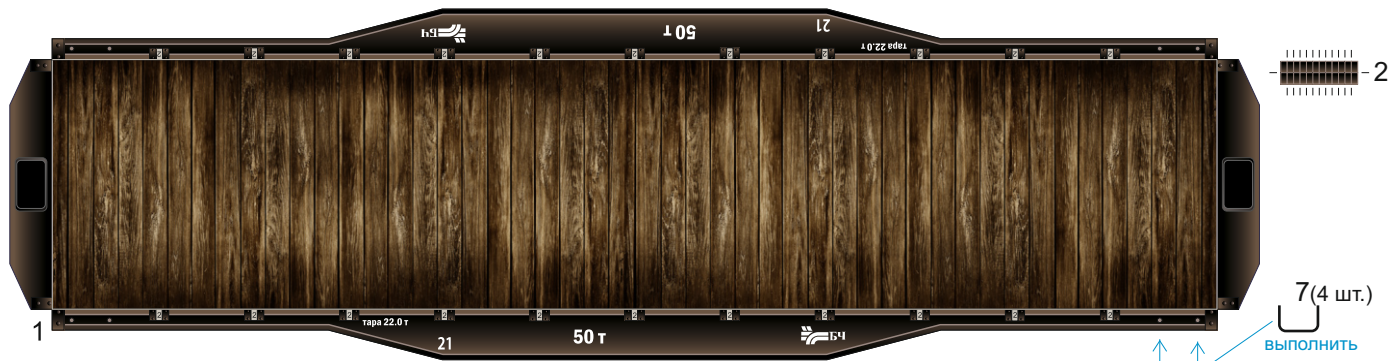

3* (подклеить под дет.1)

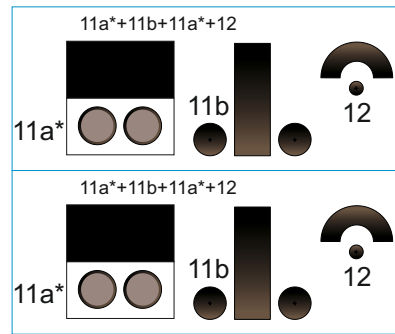
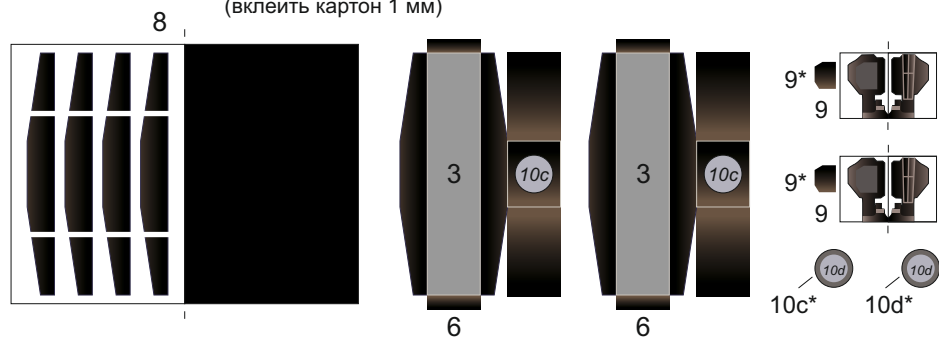
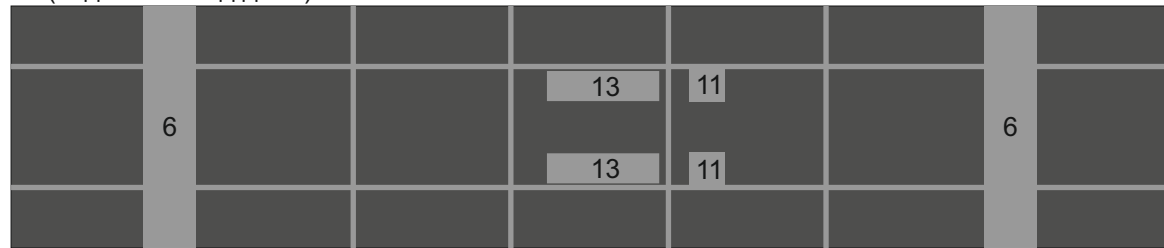

Вариант Б

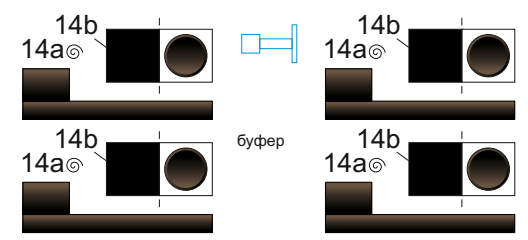
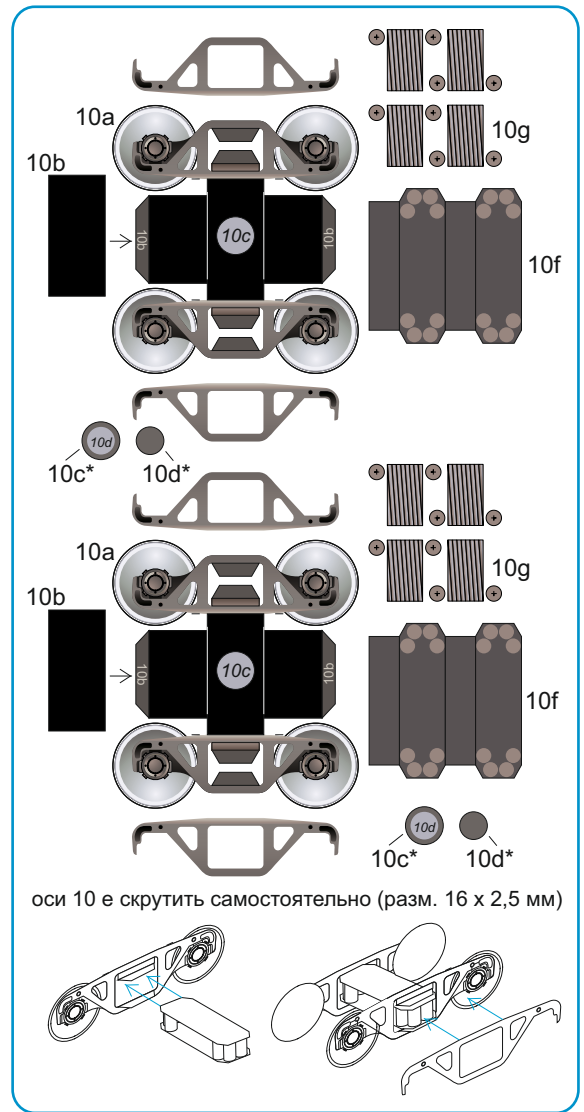

7(4 шт.)
выполнить из проволоки

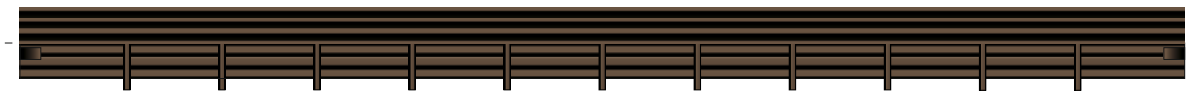
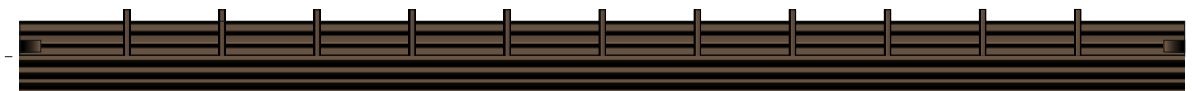

Борта клеить не обязательно,
а если клеить, то убирать
детали №2, а борта клеить
на эти посадочные места.

