

Bauzeichnung

T12

(Berliner Stadtbahnlok)

IN DER REIHENFOLGE DER ZIFFERN VORGEHEN

ZUSÄTZLICHES MATERIAL:

- 2 KNICKBARE STROHHALME
- 2 DÜNNE STROHHALME
- 2 SCHASCHLIKSPIESSE
- 3 ZAHNSTOCHER
- DÜNNER MESSINGDRAHT
0,3 MM - 0,5 MM Ø

→ DAMIT DIE RÄDER ROLLEN:
SCHASCHLIKSPIEß ALS ACHSE UND ALS
ABSTANDSHALTER DÜNNE TRINKHALME
(32 mm LÄNGE) [35 mm SPURWEITE]
STROHHALM KANN DANN IN RADLAGER
209 UND 210 EINGEKLEBT WERDEN

2 SPITZEN
VON
ZAHNSTOCHERN
ALS VENTILE
(GRÜN)

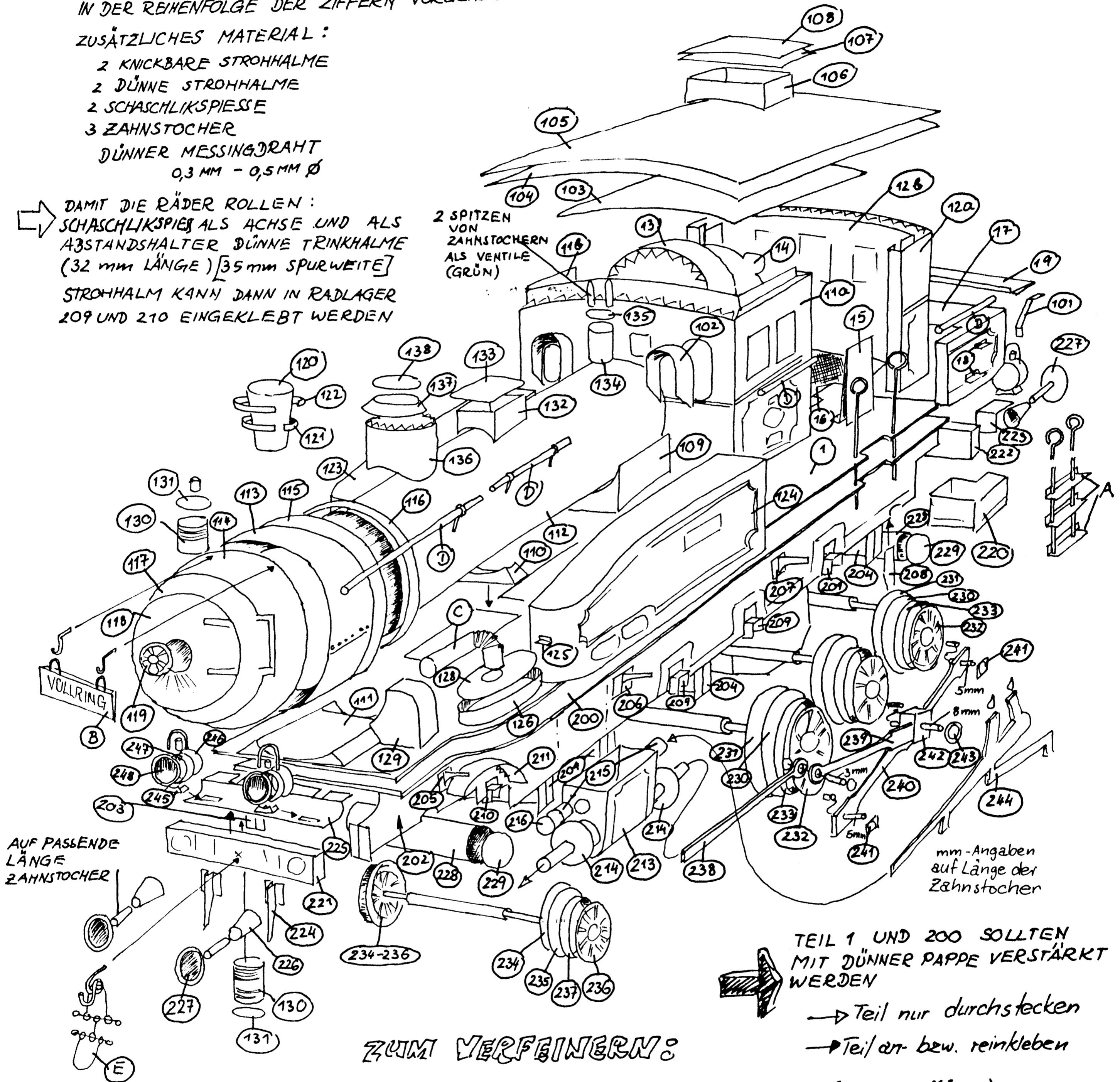

TEIL 1 UND 200 SOLLTEN
MIT DÜNNER PAPPE VERSTÄRKT
WERDEN

→ Teil nur durchstecken
→ Teil an- bzw. reinkleben

ZUM VERFEINERN:

A Treppe: Geländer aus Messingdraht biegen (oben Griffösen)
Treppe-stufen aufstecken

B Richtungsschild: vor dem Zusammenkleben 2 Haken aus Messingdraht
dazwischen kleben, 2 kleine Haken biegen und an der
Rauchkammer (x Markierung) einkleben

C Knickteil vom Strohhalme schwarz bemalen und in Teil 128
und 129 einkleben

D Griffstangen: Zahnstocher auf Länge zurechtschneiden und an-
kleben, eventuell kleine Ringe aus Messingdraht zurechtbiegen
vorne am Kessel als Abstandhalter (ca 5mm)

E Kupplung: wie abgebildet aus dünnen Draht biegen und
schwarz bemalen (2x vorn und hinten)

LAMPEN:

Tragebügel aus Draht
Belüftung: passendes
Teil eines Zahnstochers

UND ALS KRÖNUNG FIGUREN
(LOKOMOTIVPERSONAL)
BAUGRÖSSE (1:43)



© 2001 Lahe/Berlin www.bastelbogen-online.de

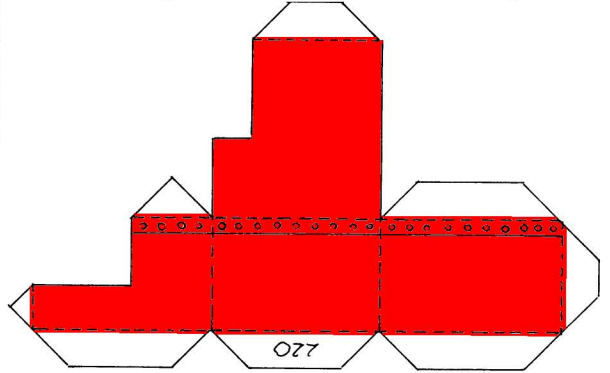
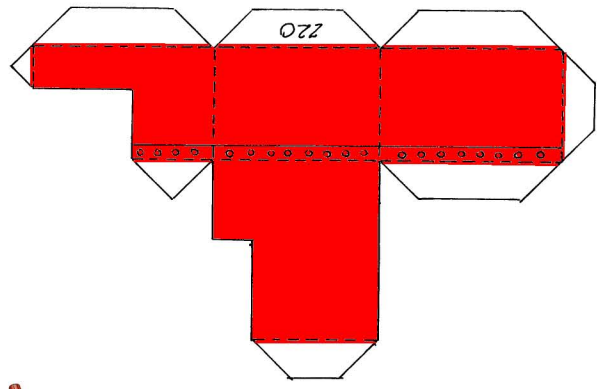

8

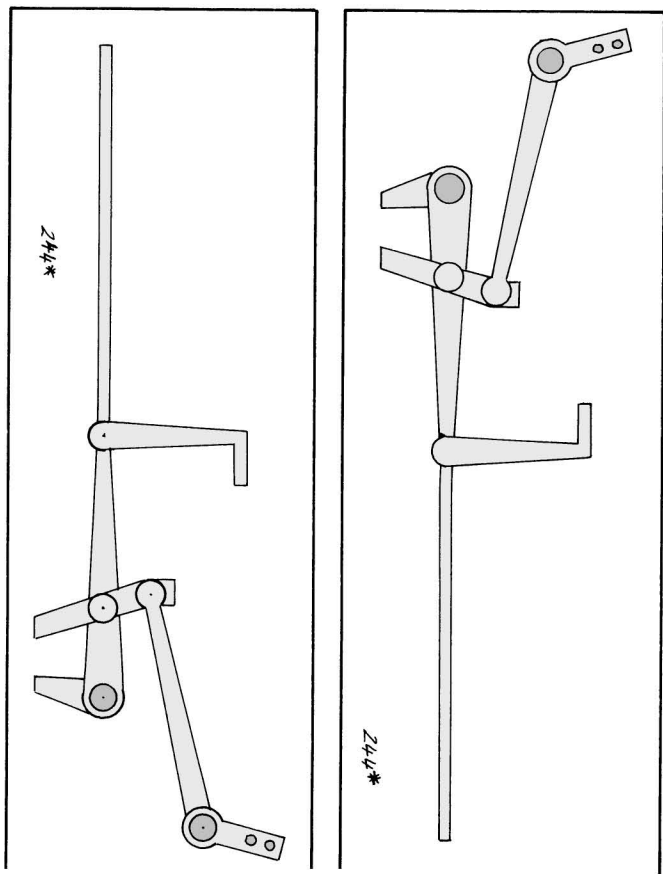
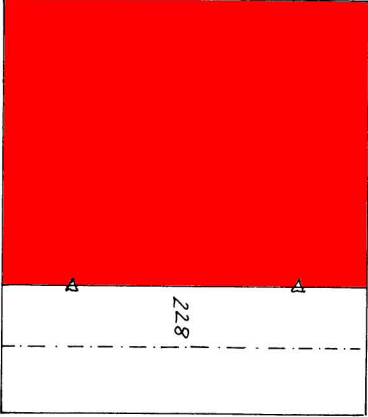
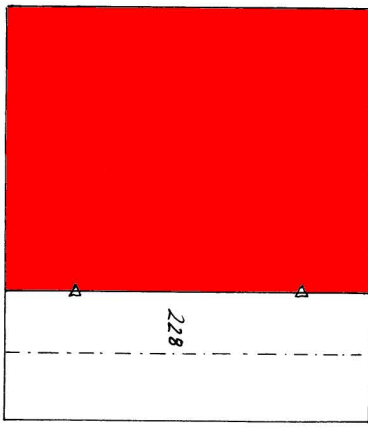

244*

244*

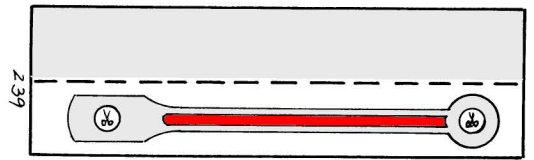

239

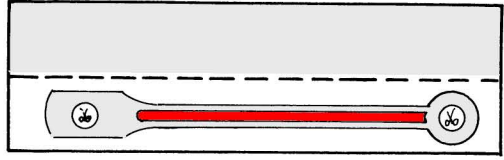

239

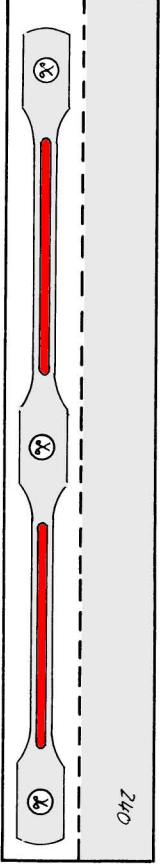

240

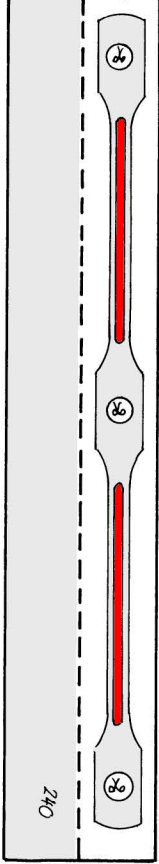

240

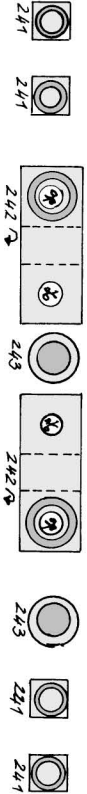

241

241

242

243

242

243

241

241

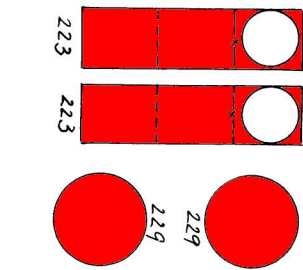

223

223

229

229

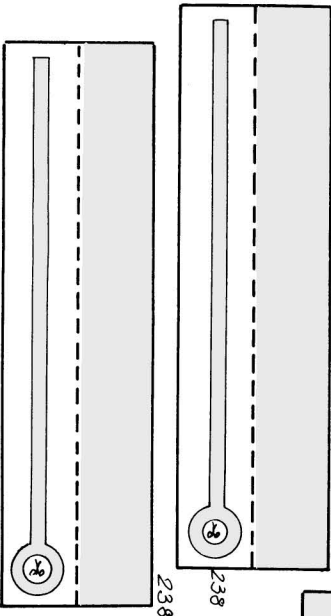

238

238

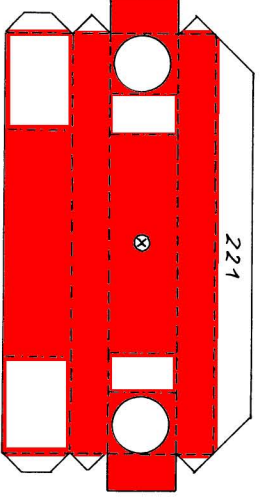

221

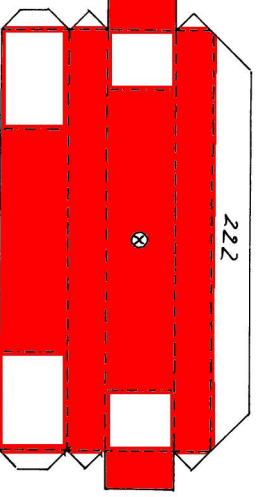

222

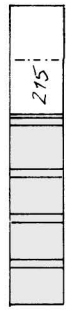
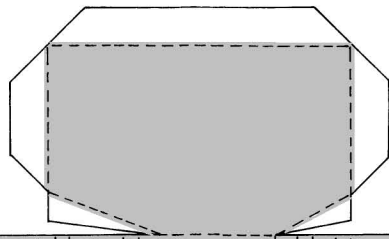
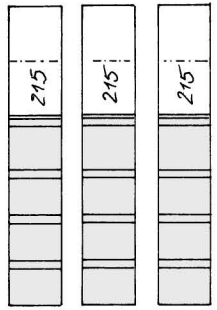
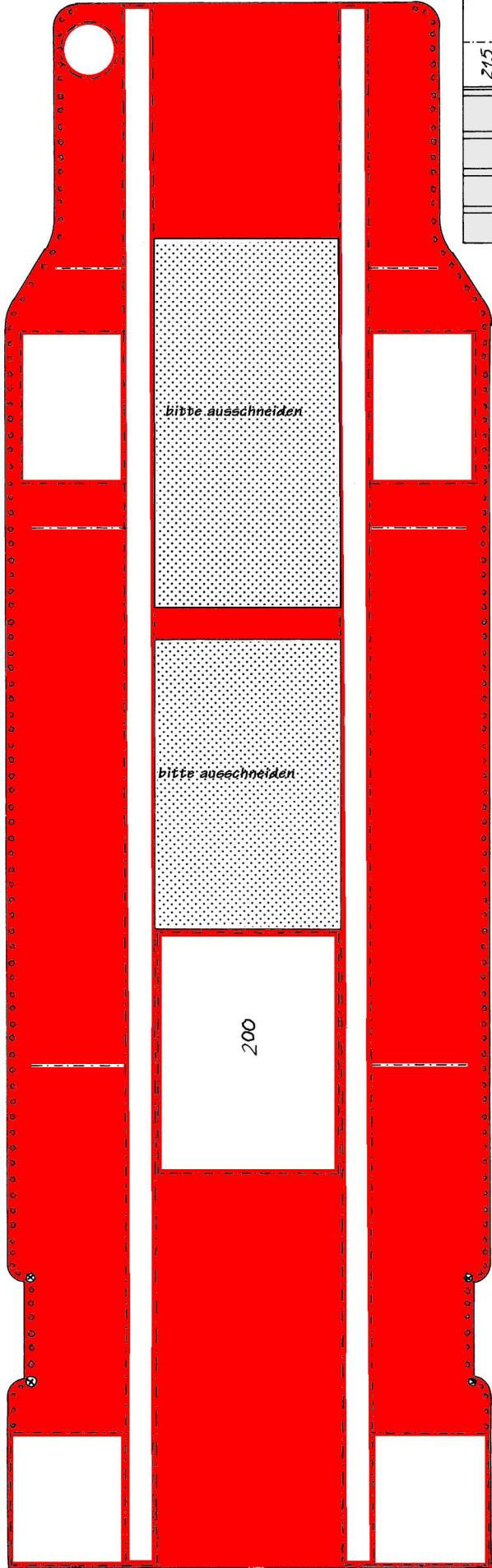

© 2001 Lahe/Berlin www.bastelbogen-online.de

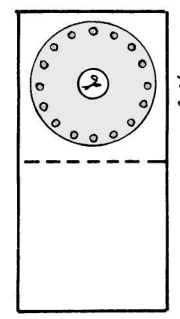
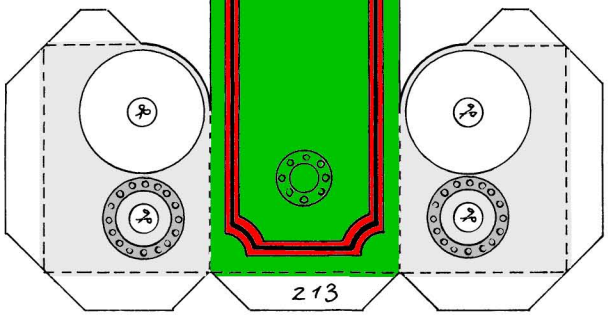
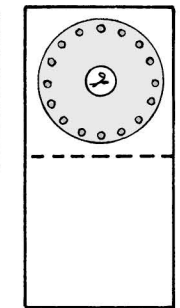
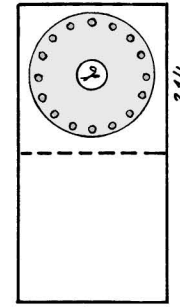
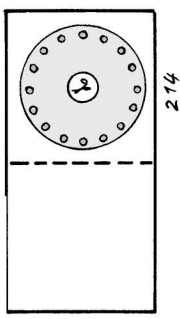
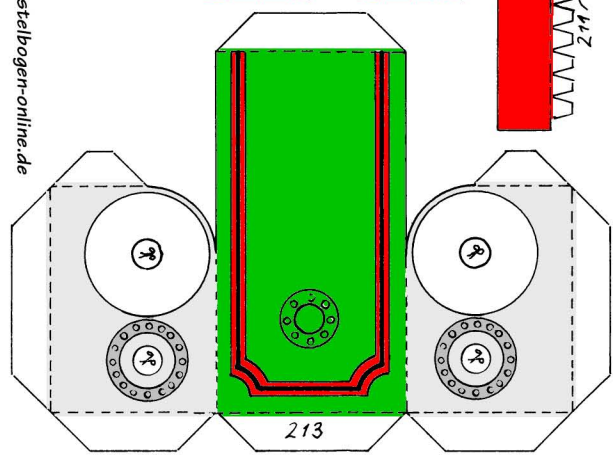
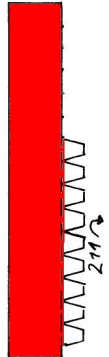
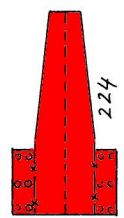
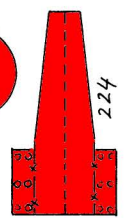
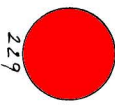
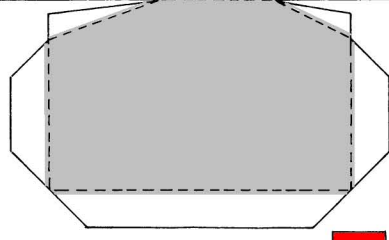
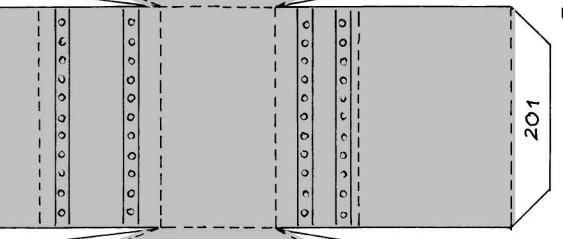



© 2001 Lahe/Berlin www.bastelbogen-online.de

