

Page001 to Page161 are printed on 67lb/147gsm/7.5mil paper.  
Page162 to Page195 are printed on 20lb/75gsm/4mil paper.

Scaling 100%

Don't use fit to paper

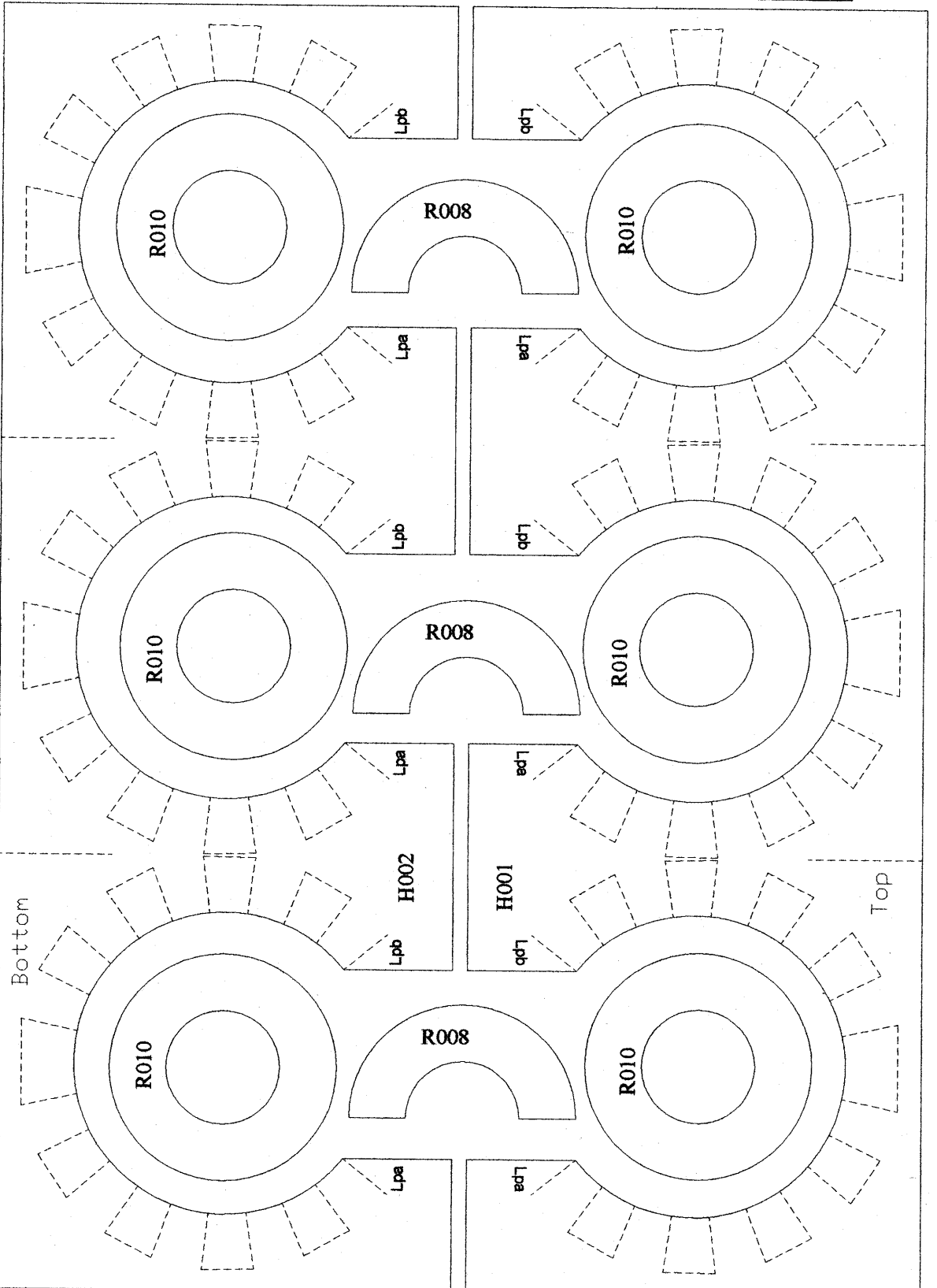

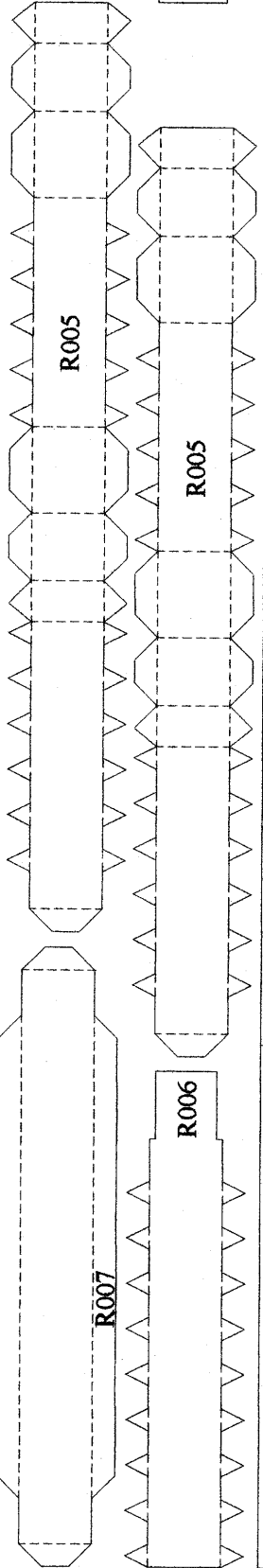
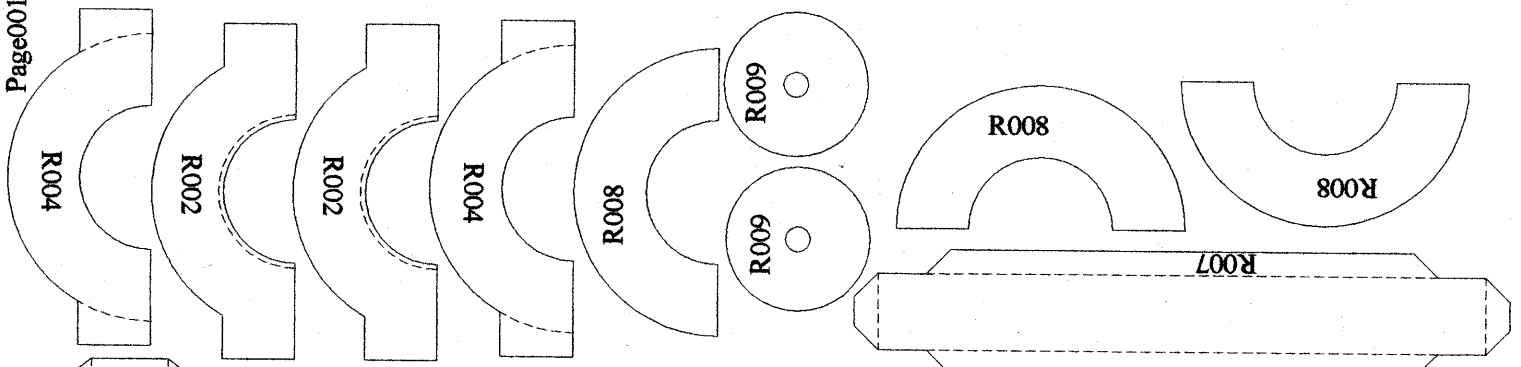
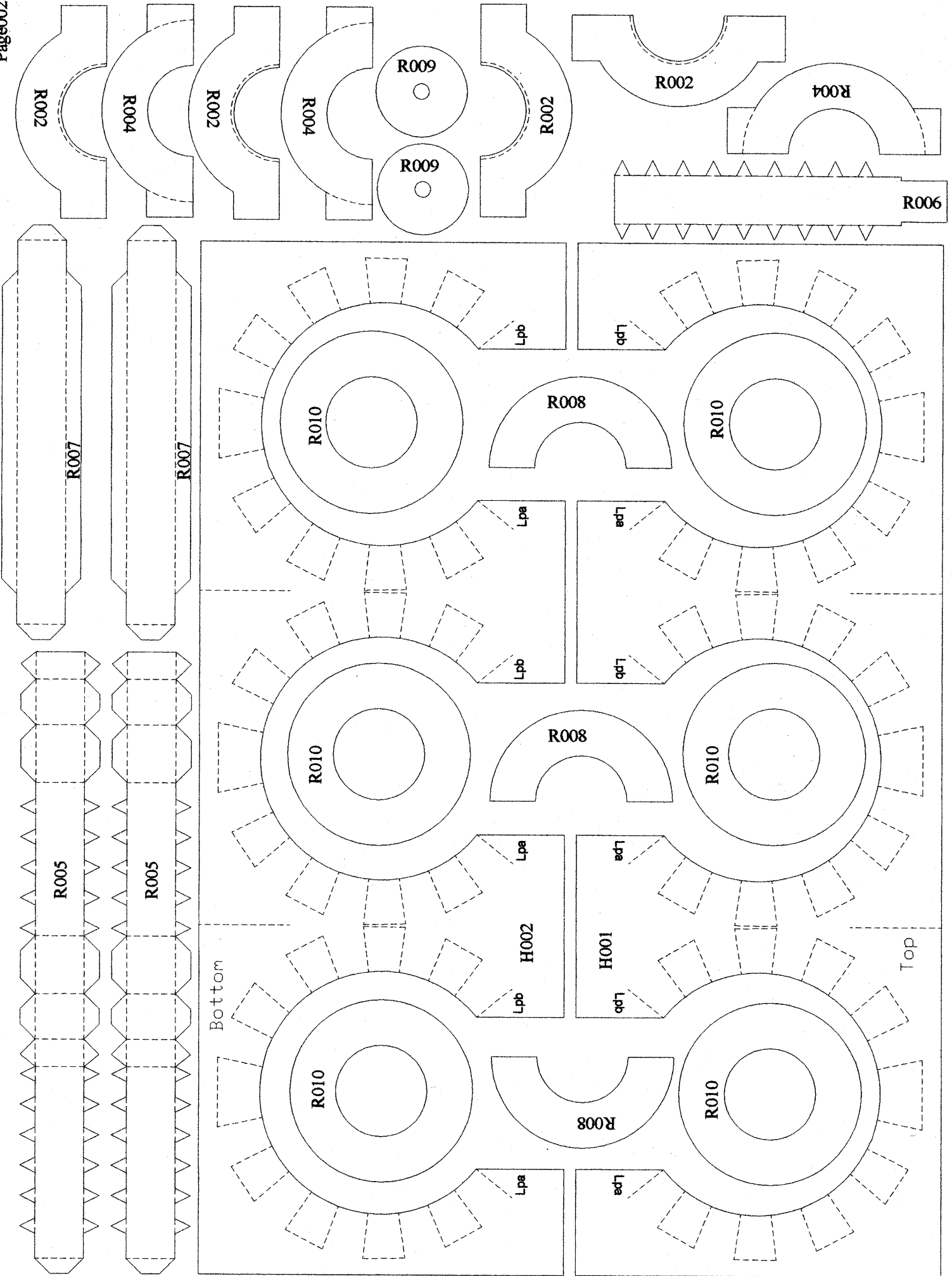

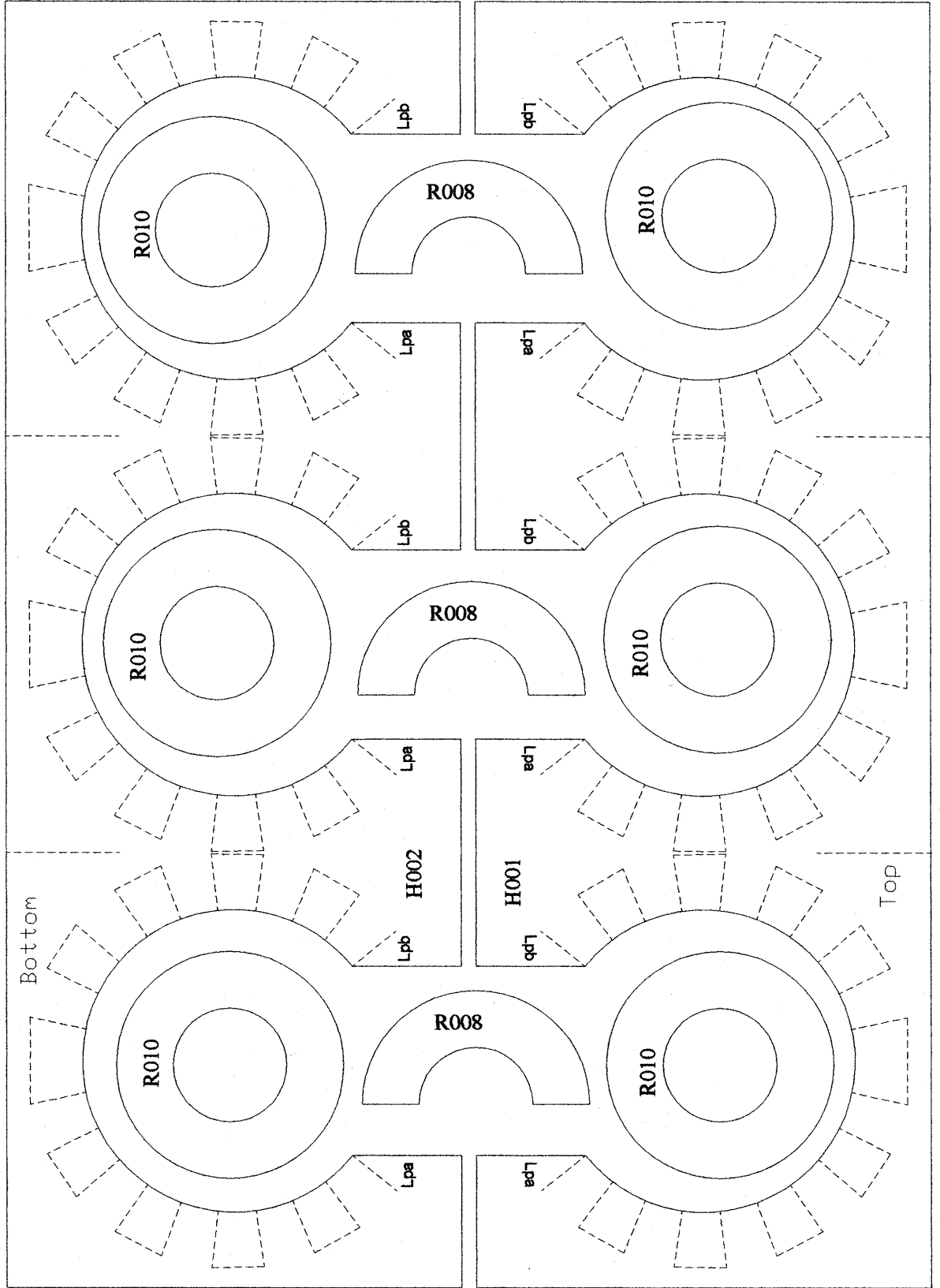
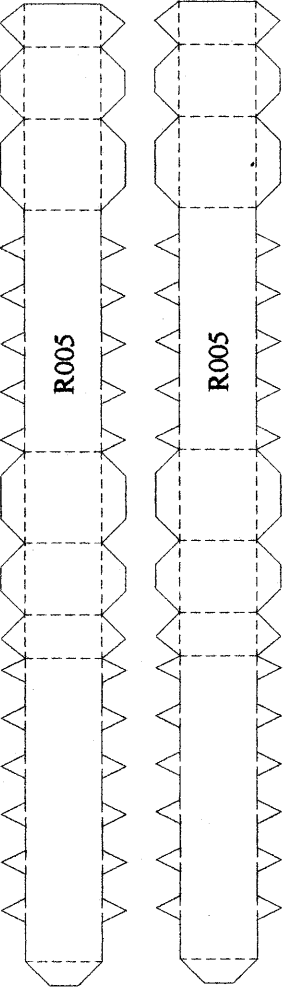
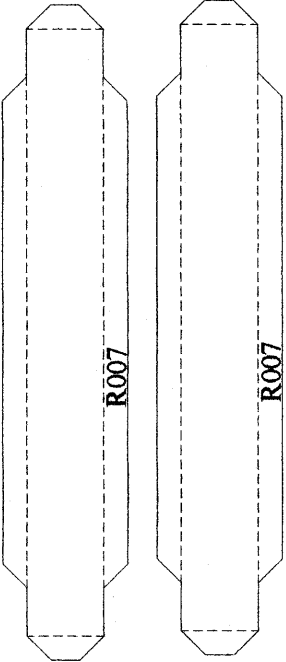
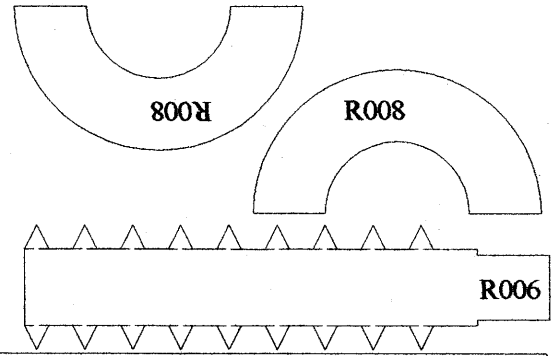
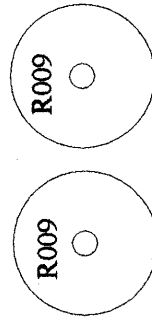
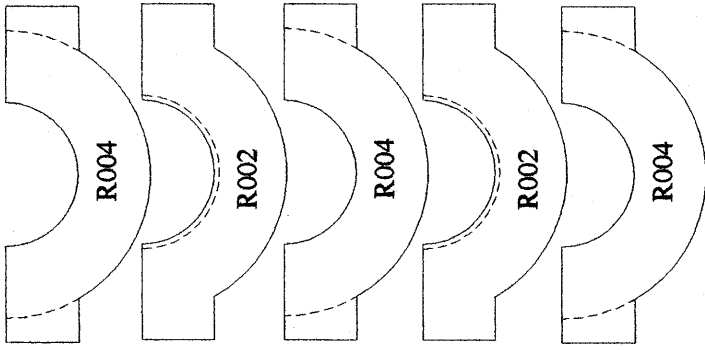



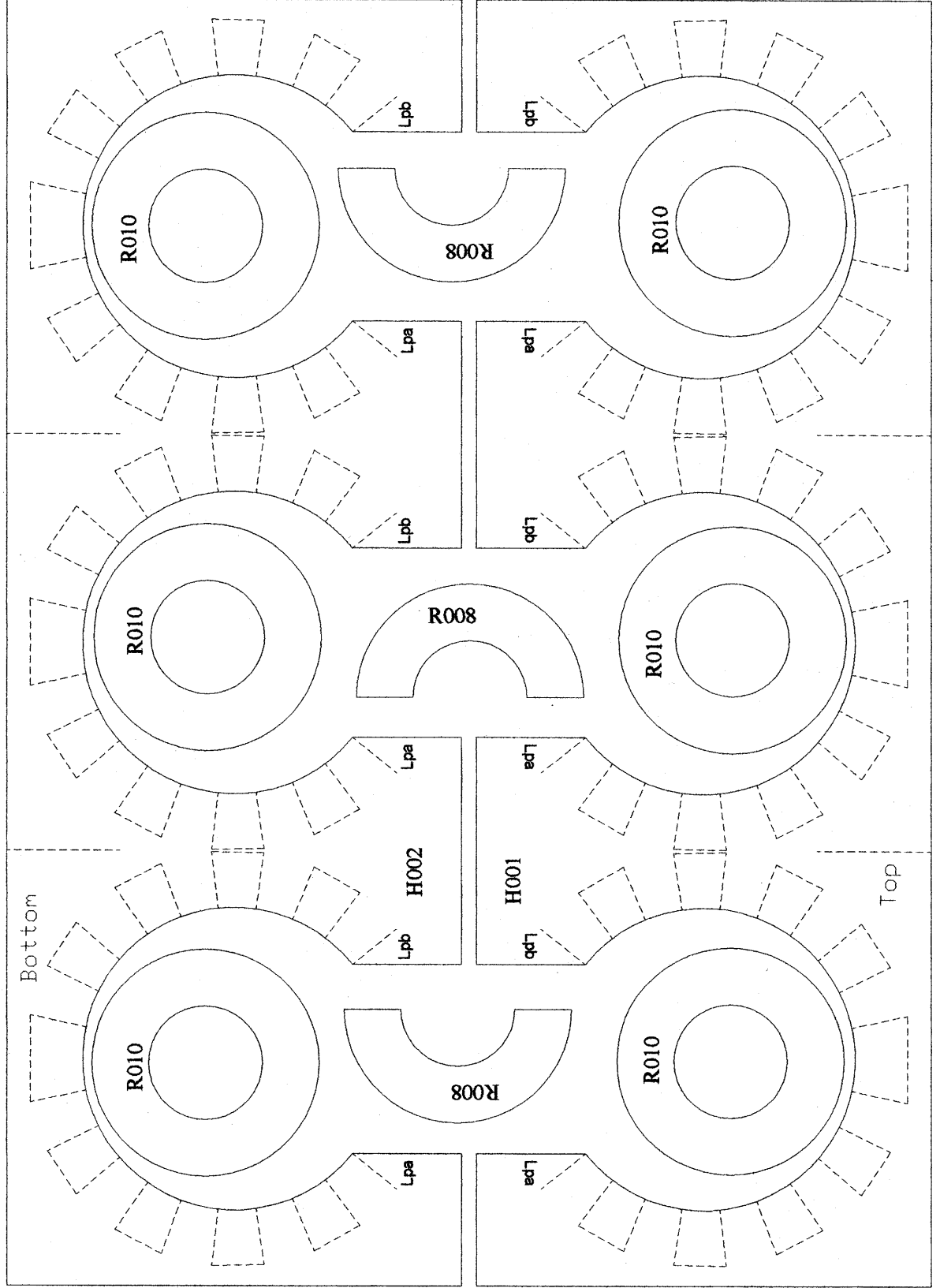
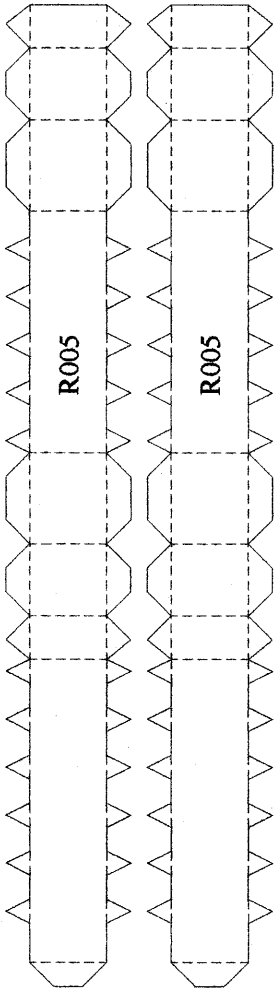
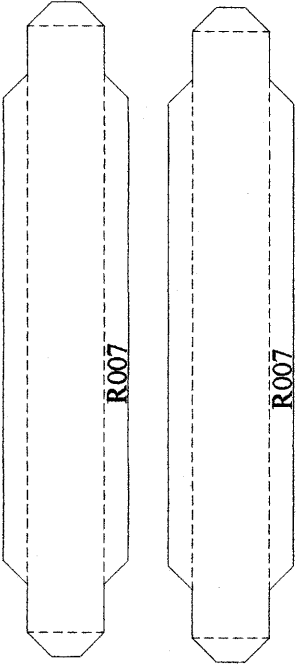
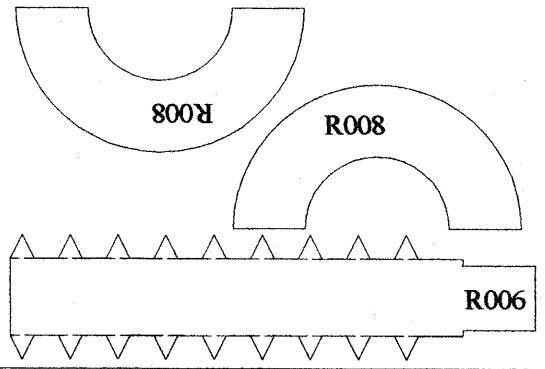
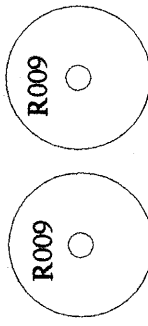
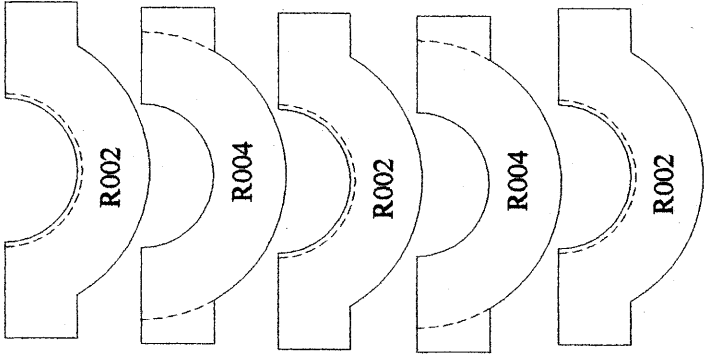

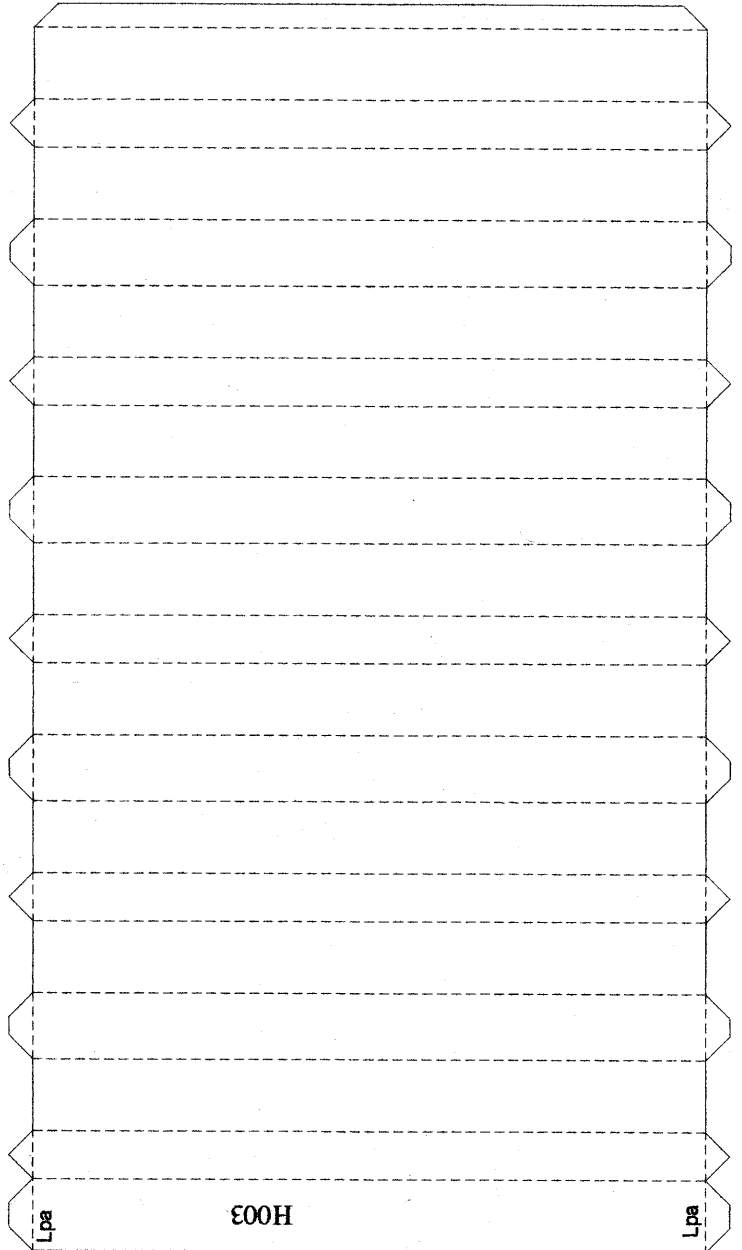
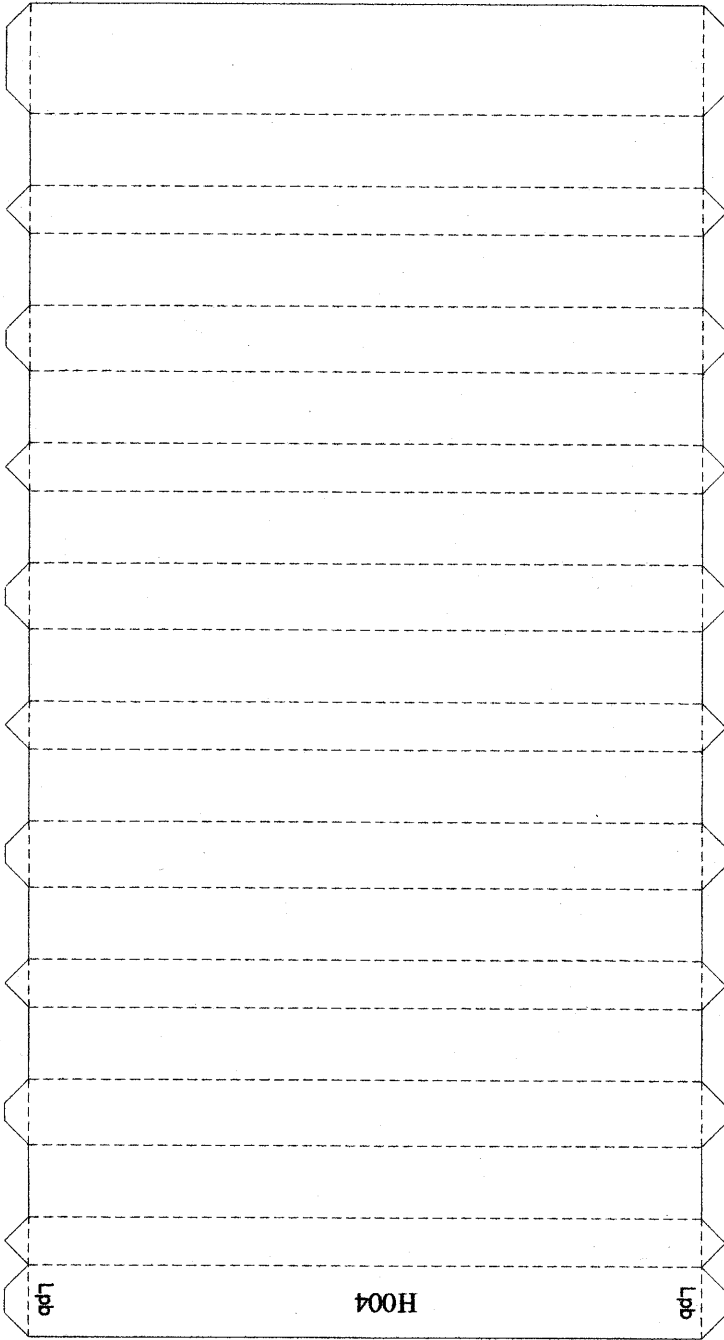
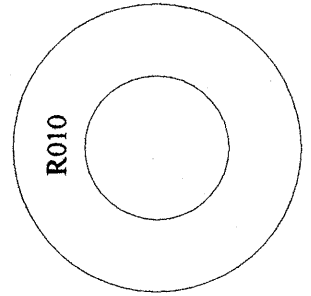
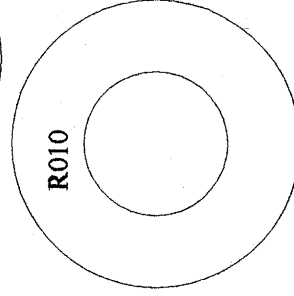
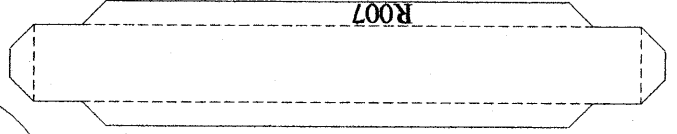
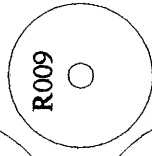
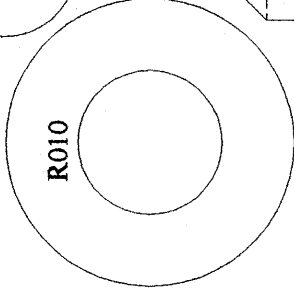
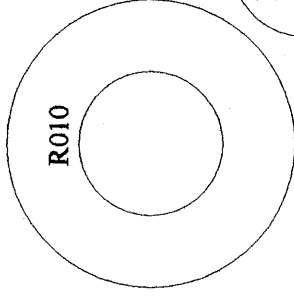
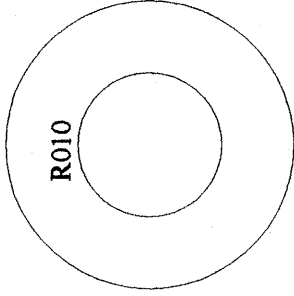
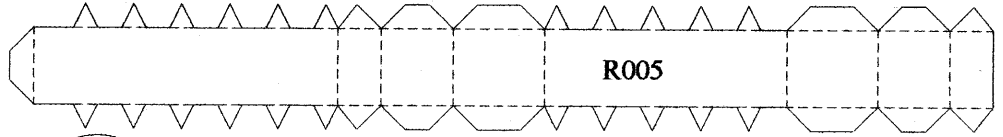
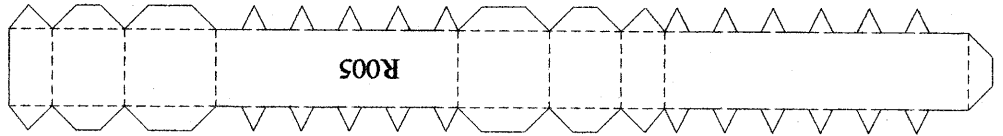
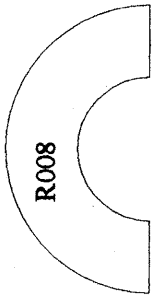
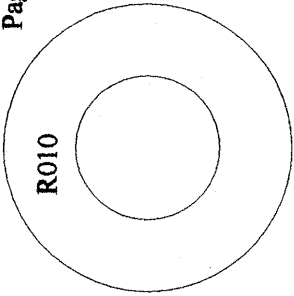

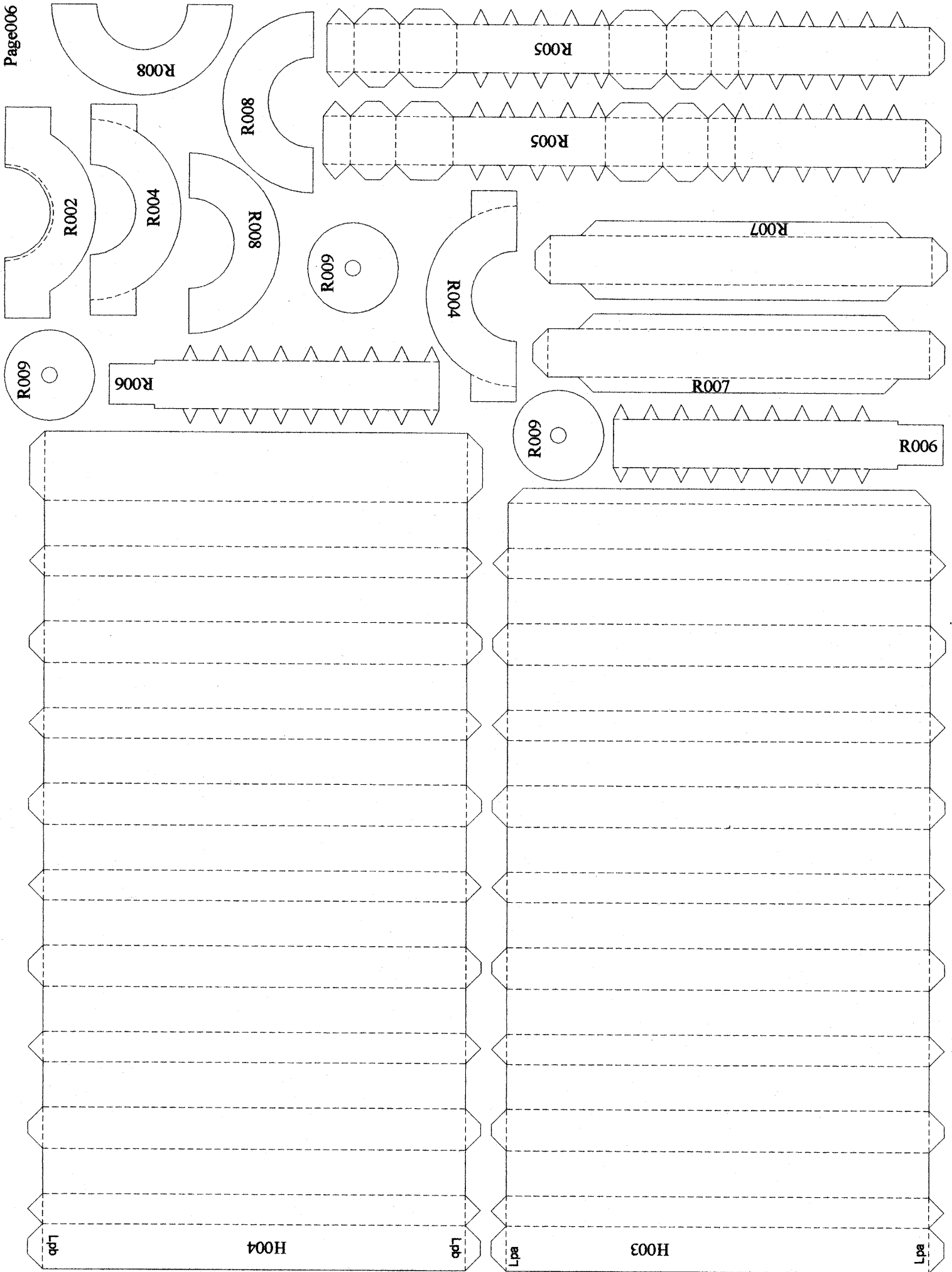

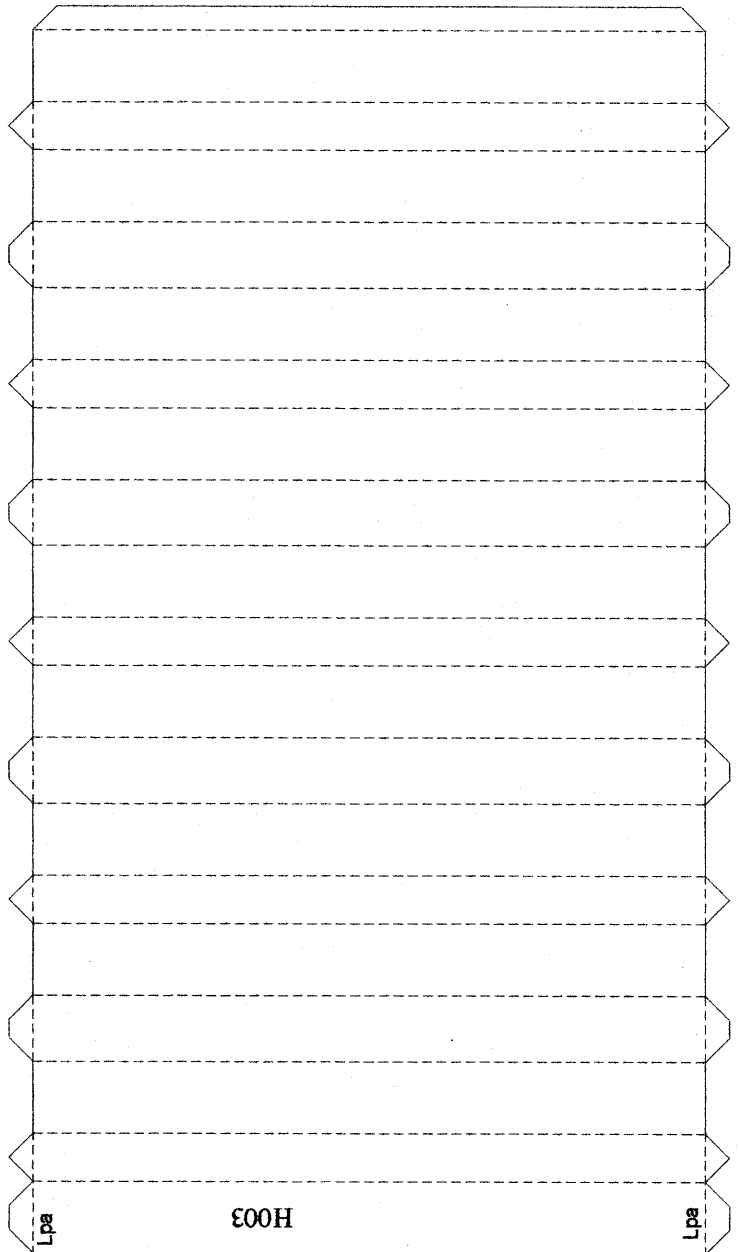
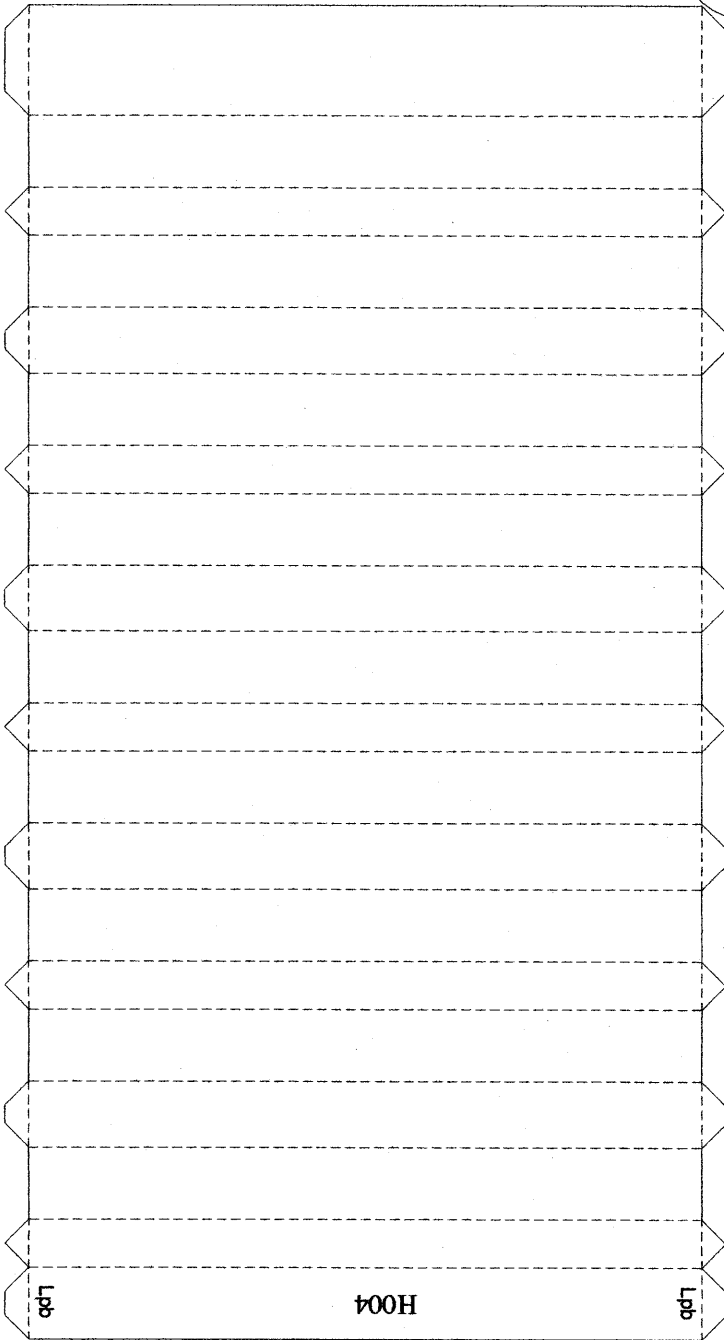
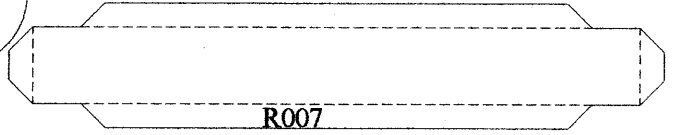
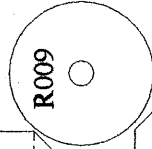
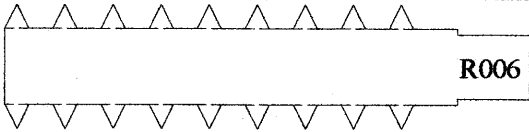
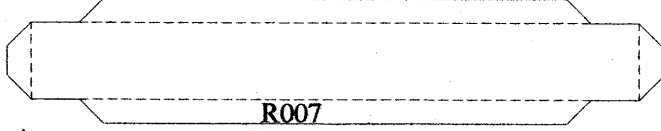
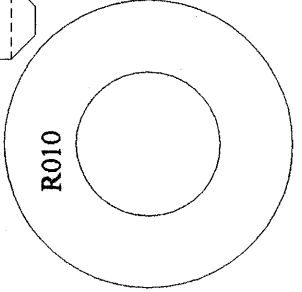
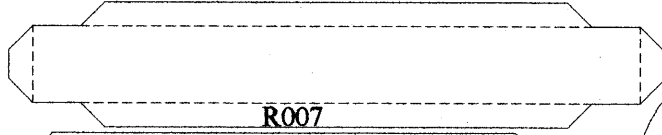
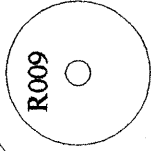
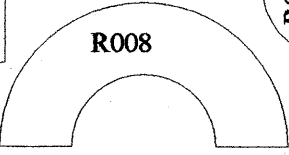
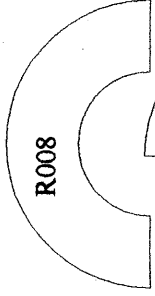
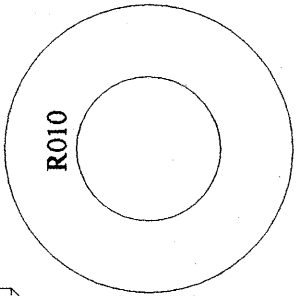
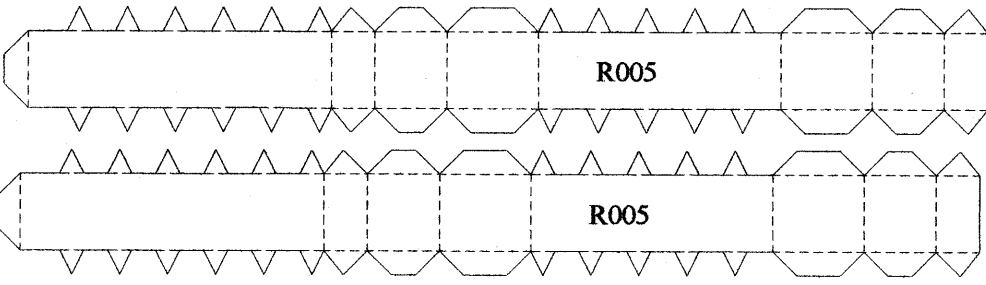
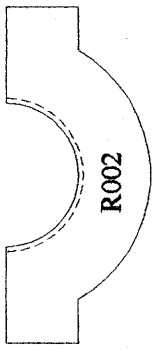

H004

H003

Lpb

Lpb

Lpa

Lpa

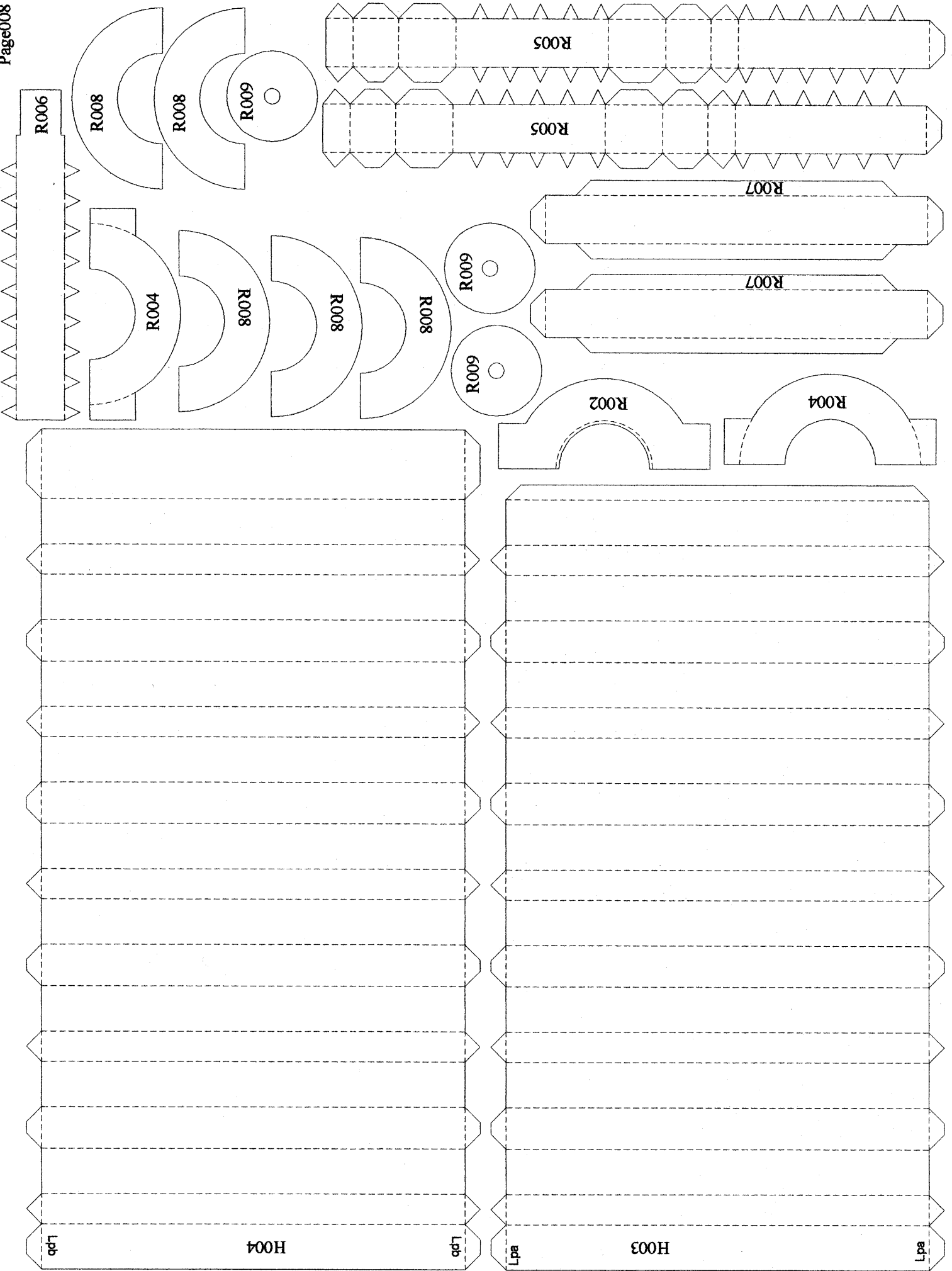

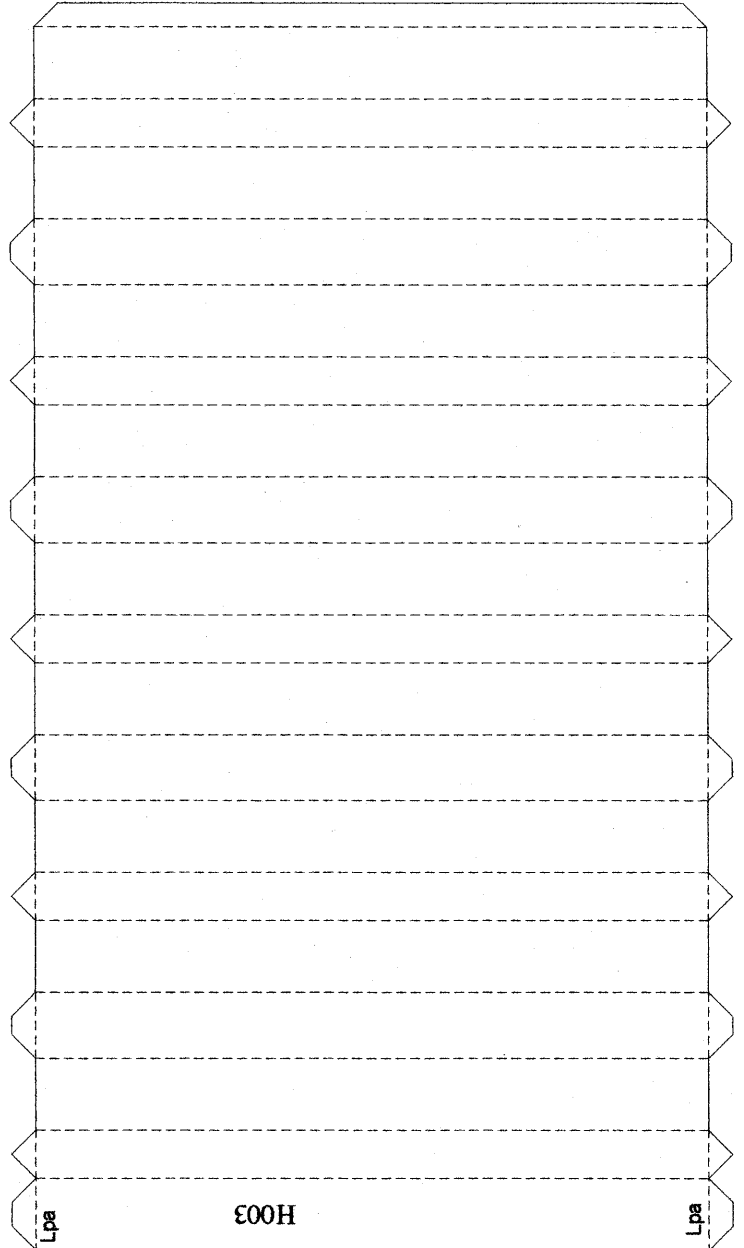
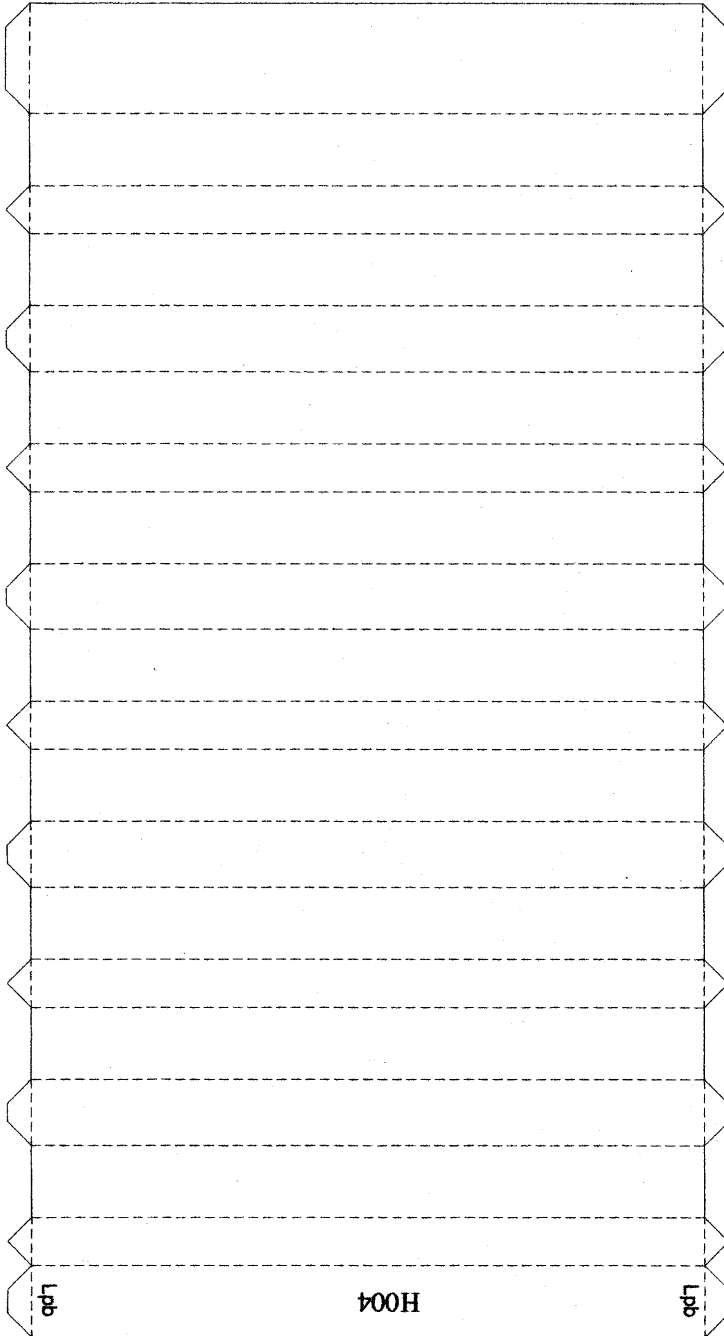
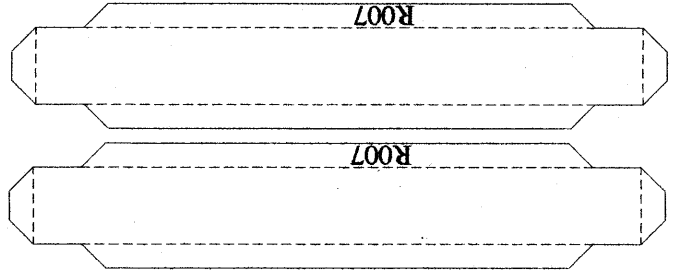
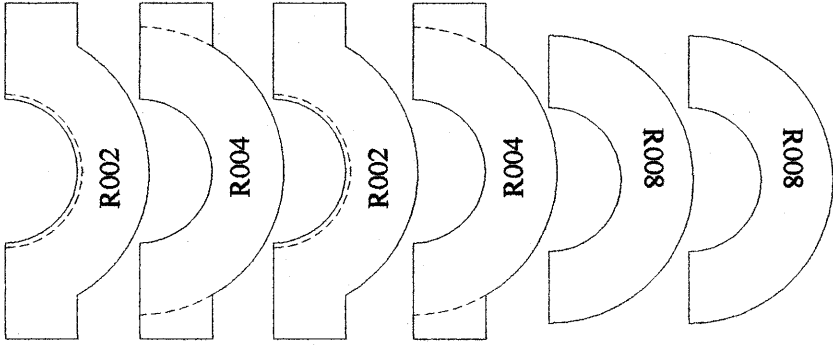
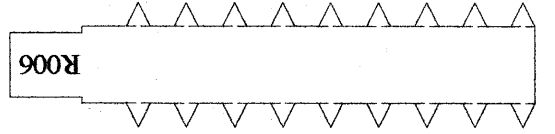
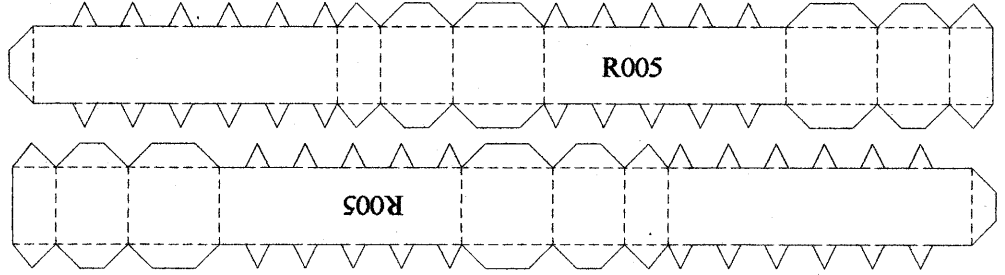
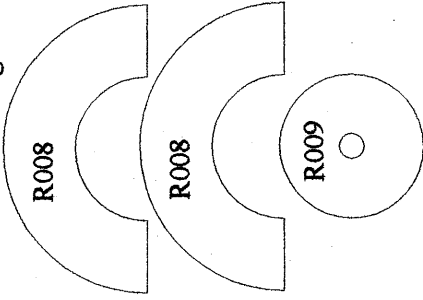

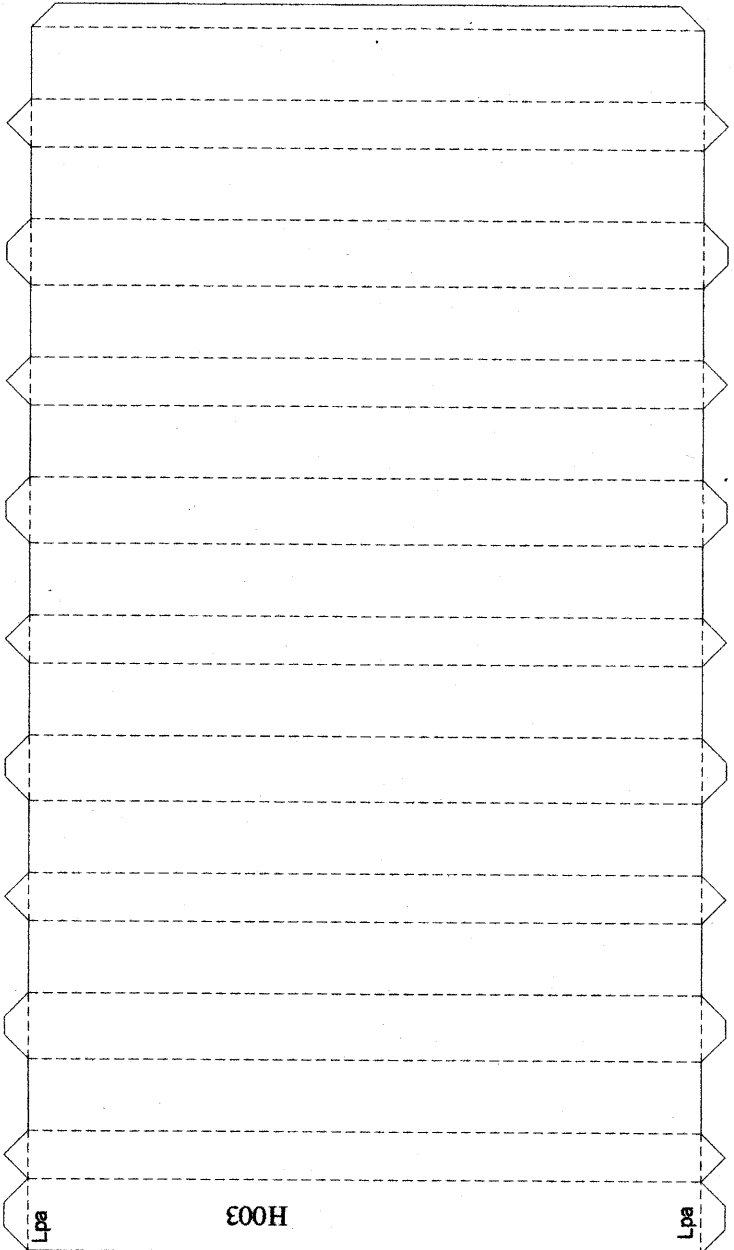
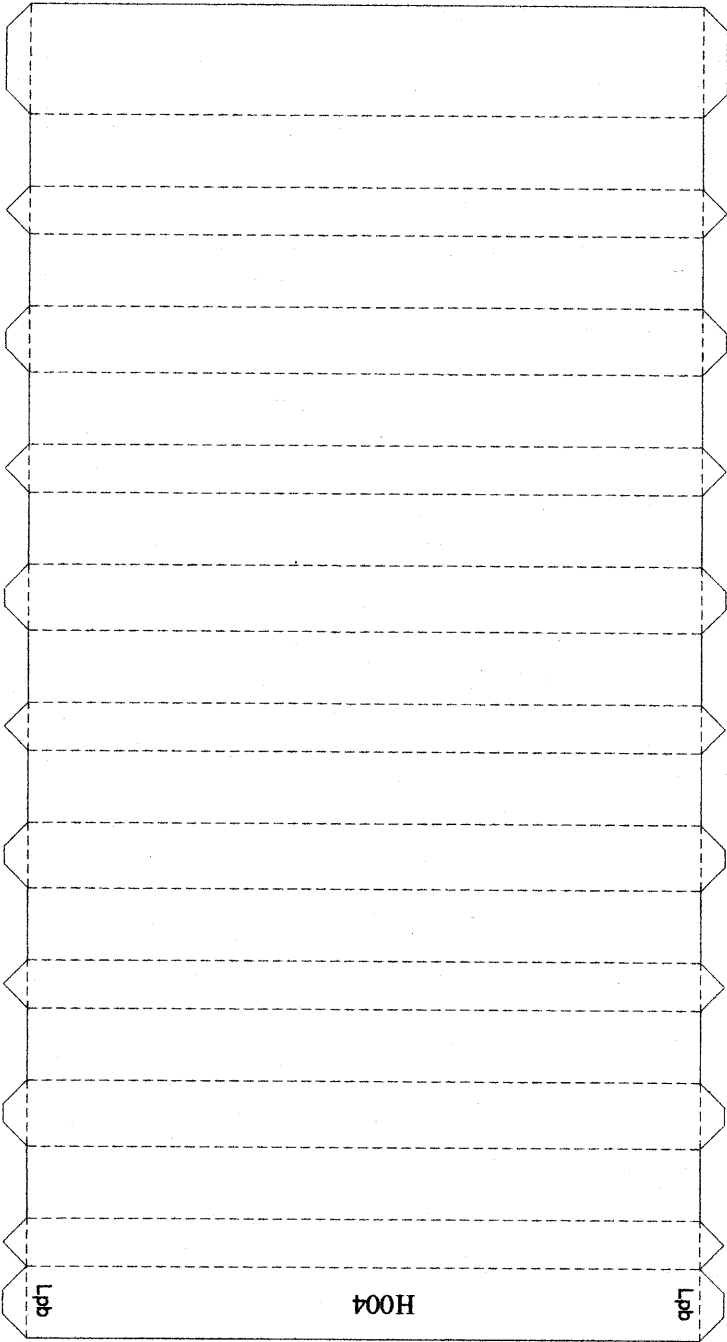
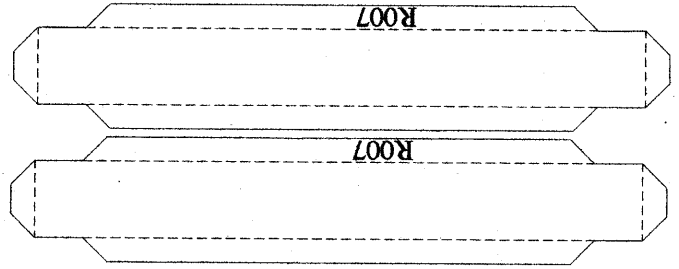
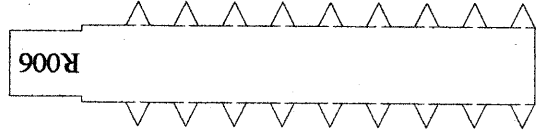
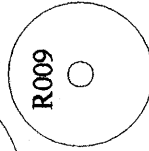
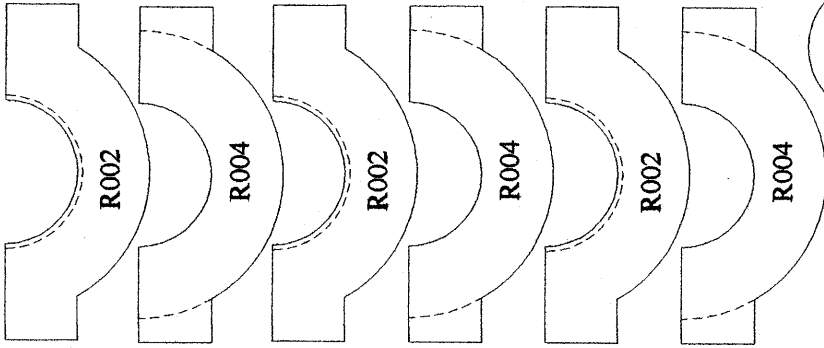
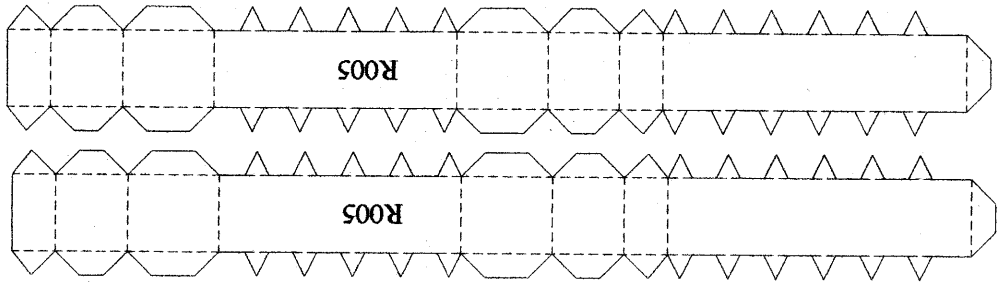
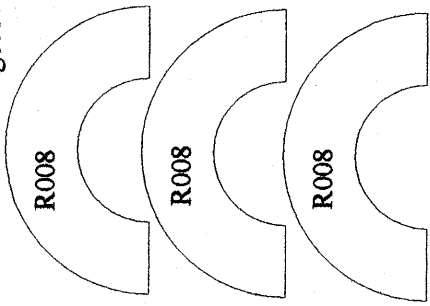

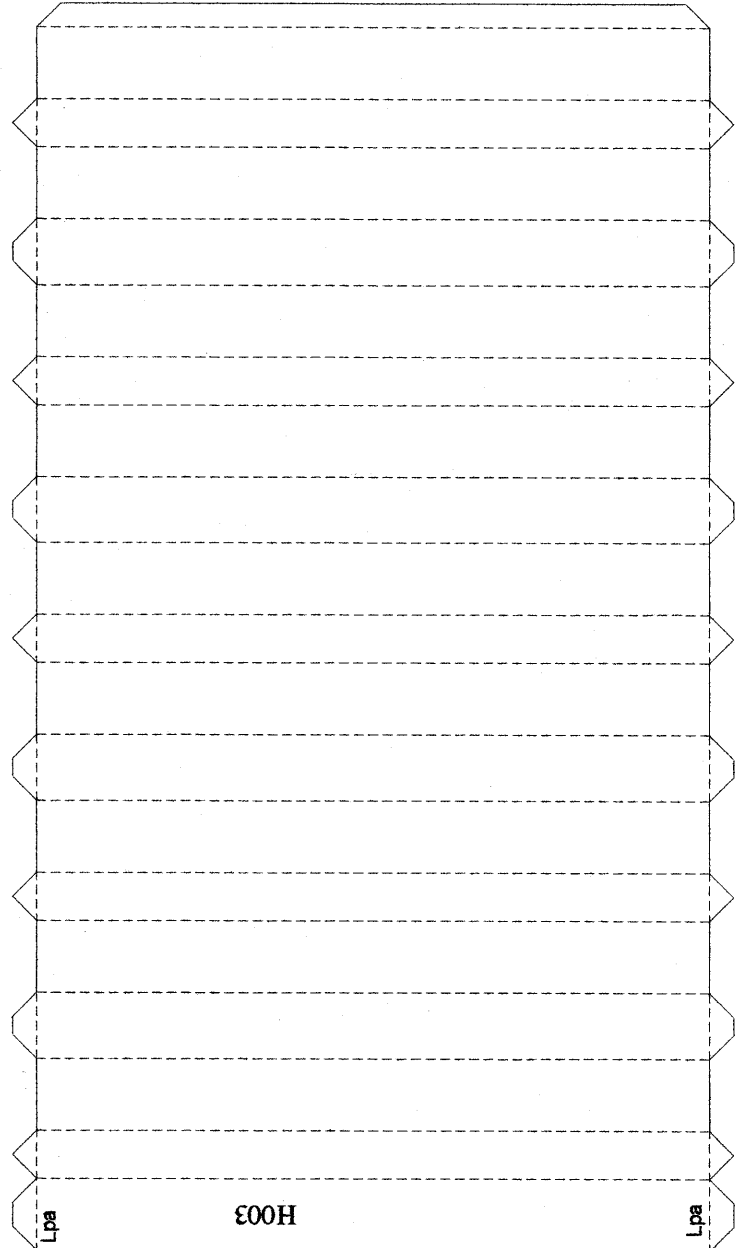
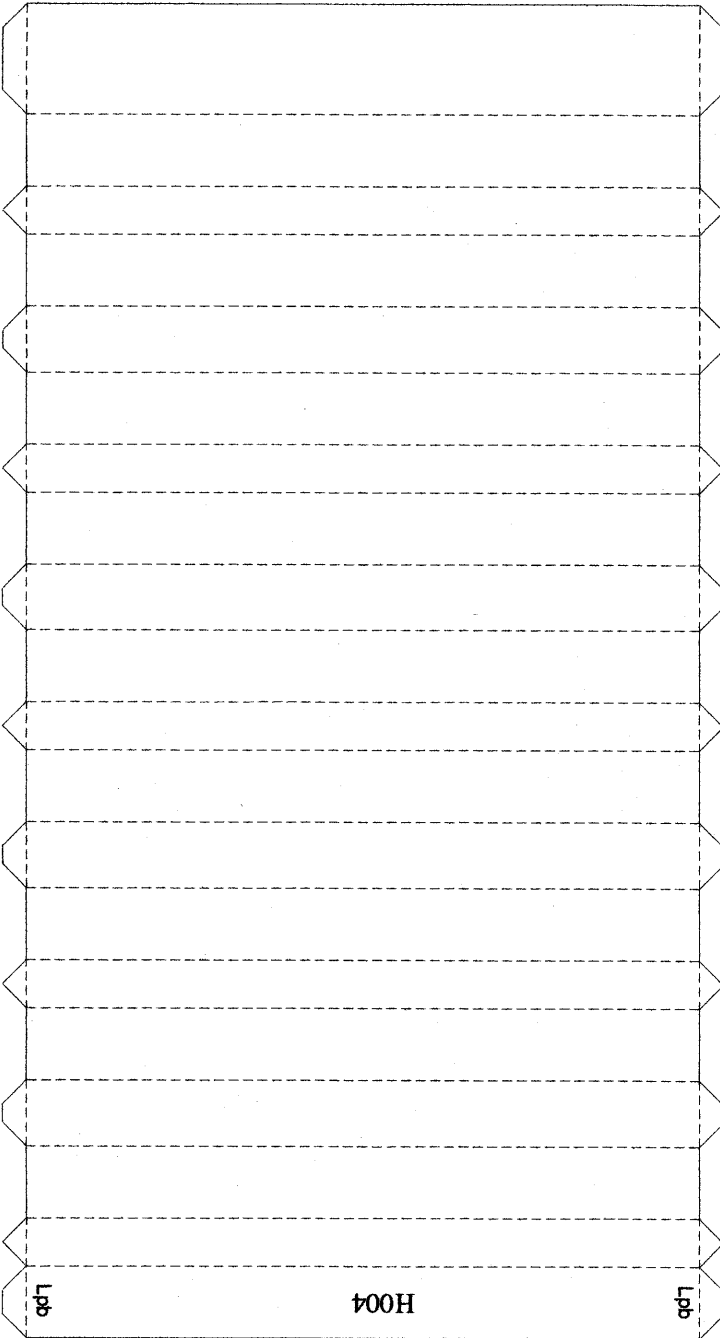
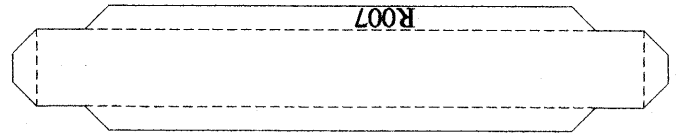
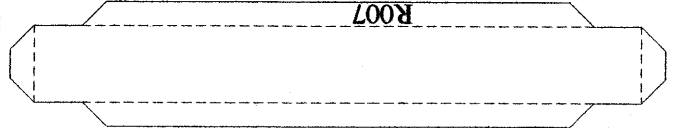
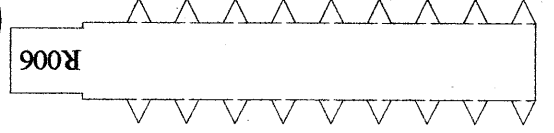
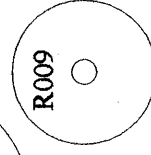
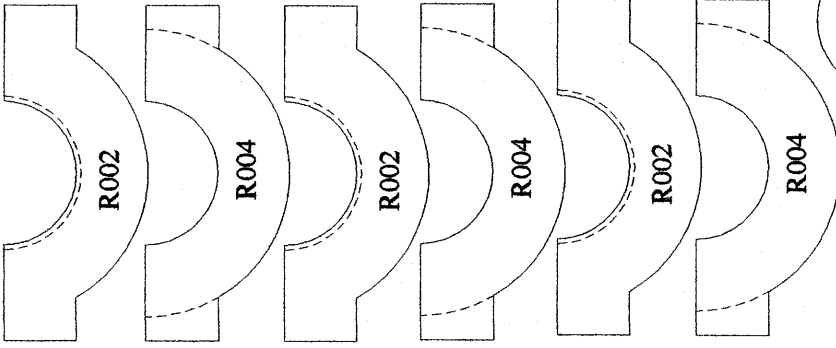
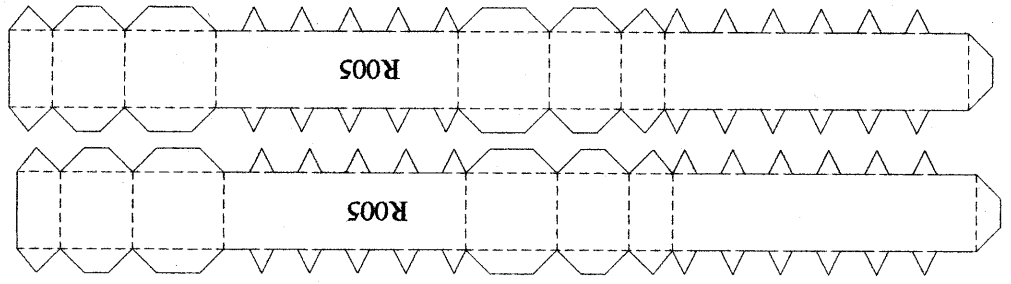
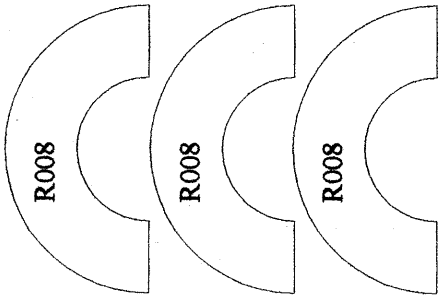



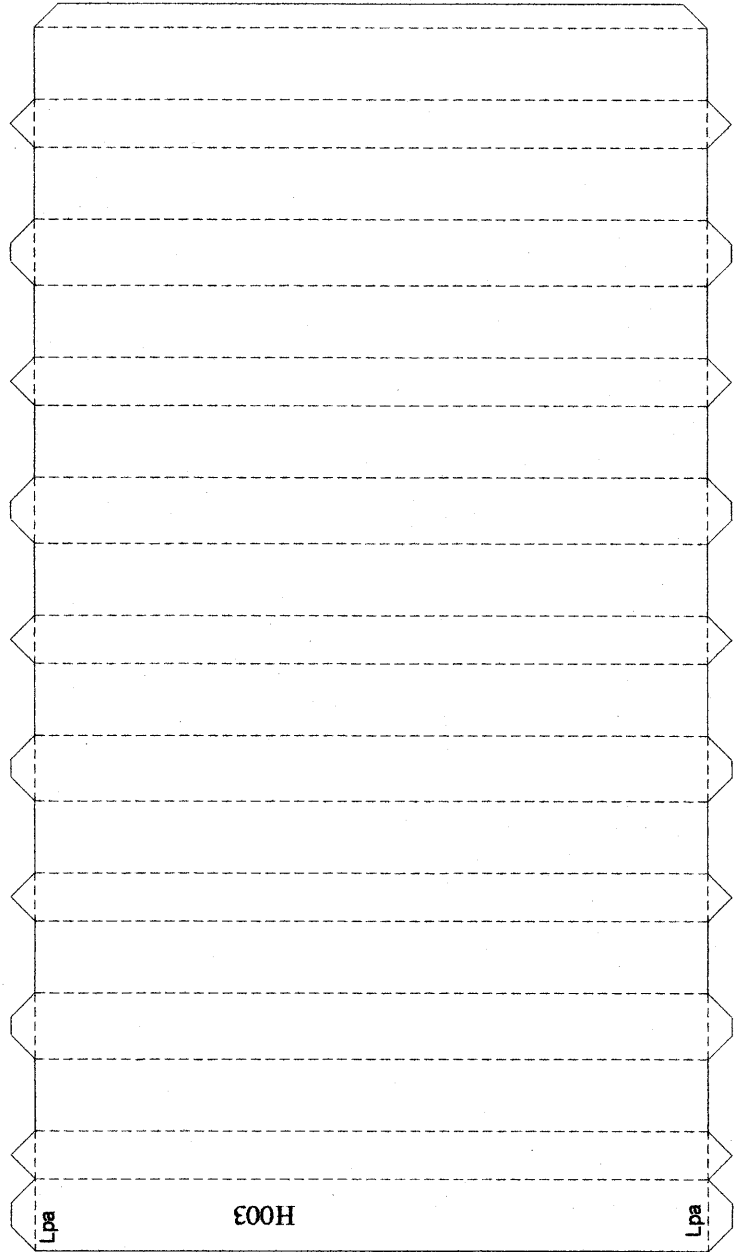
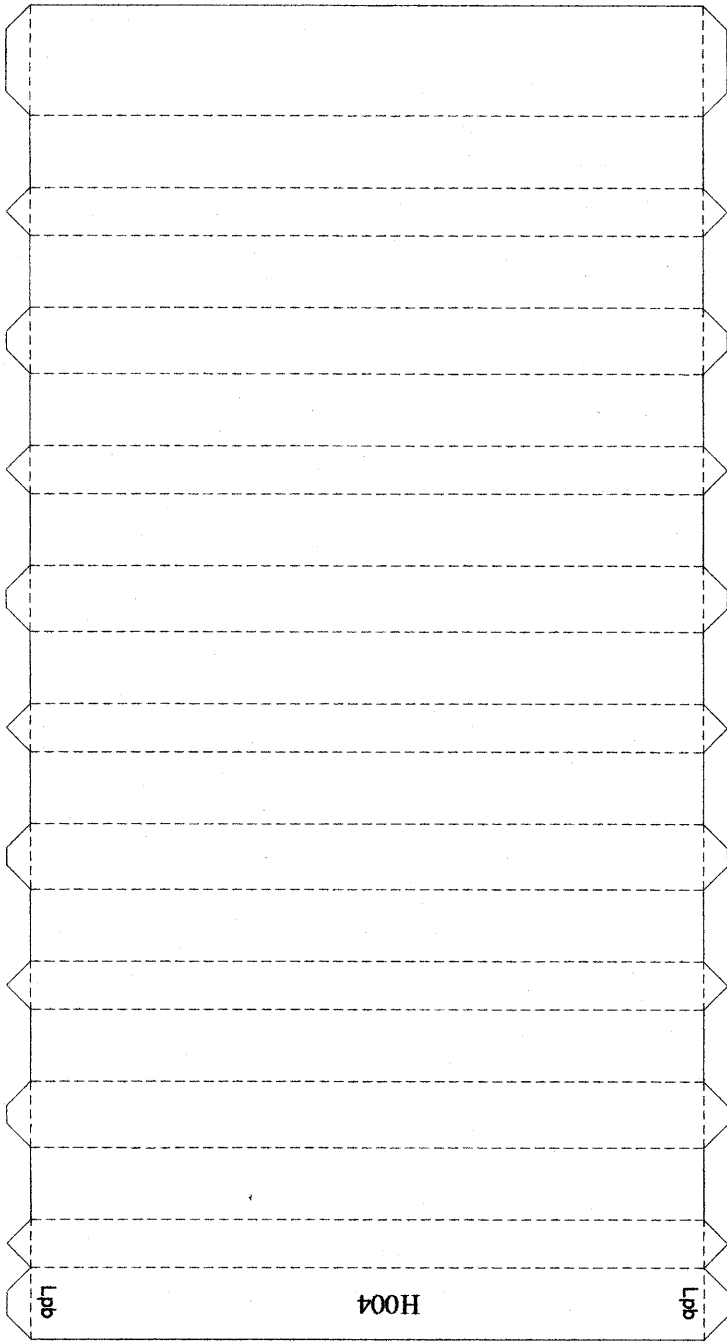
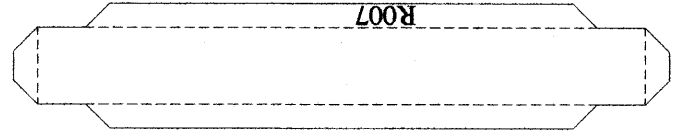
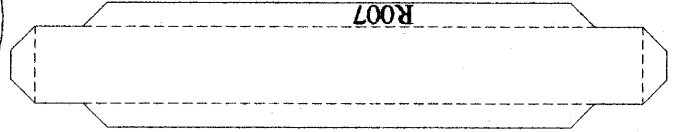
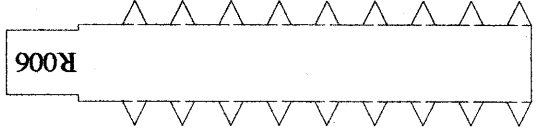
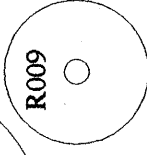
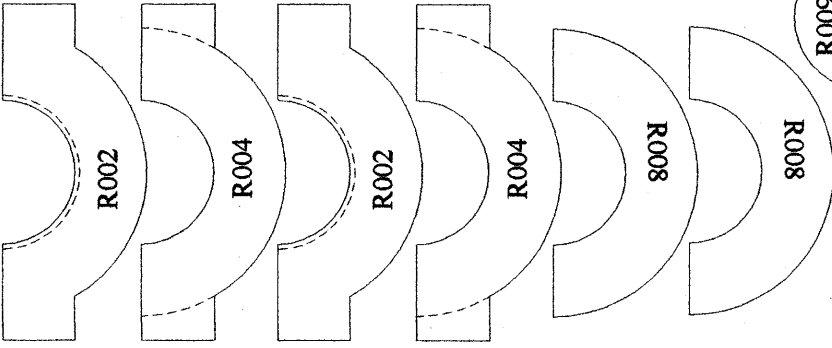
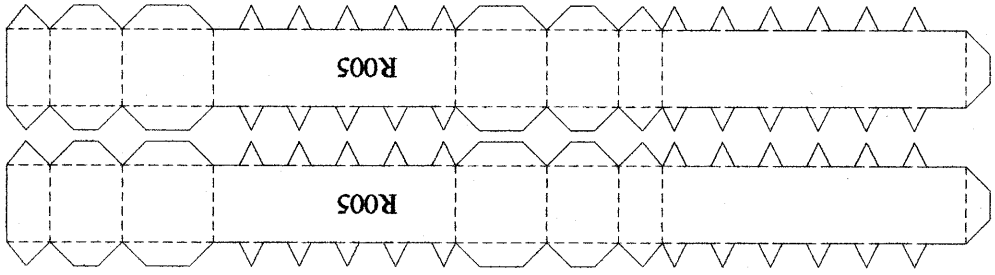
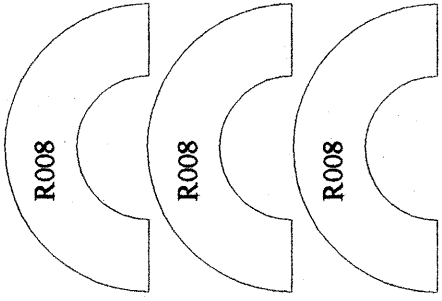

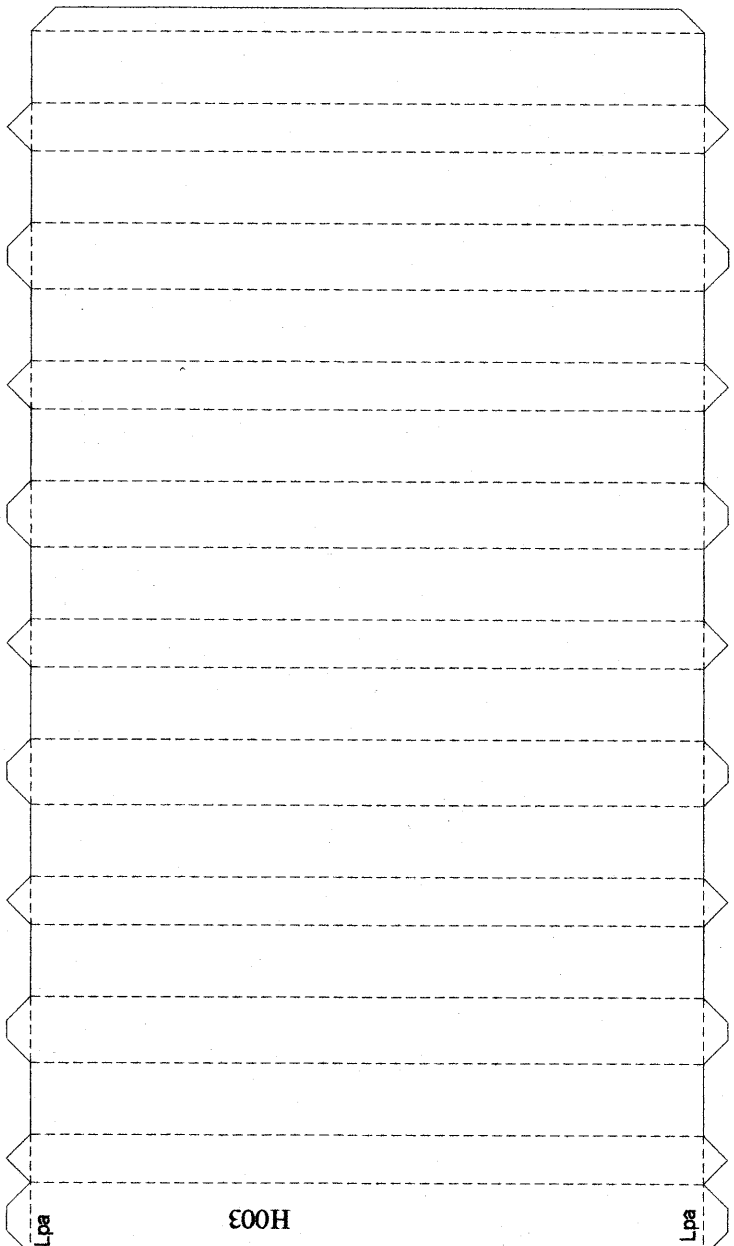
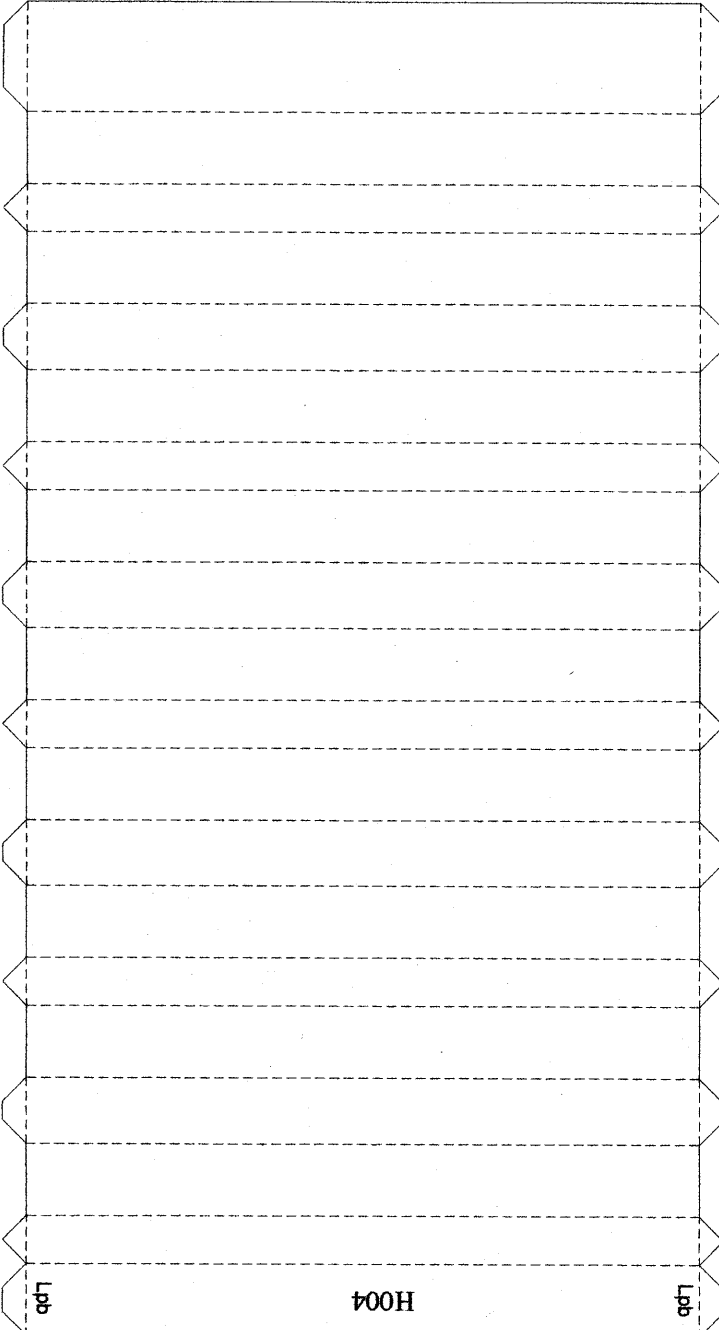
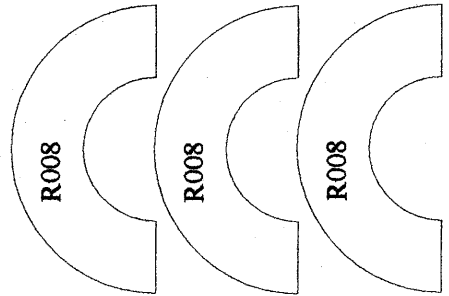
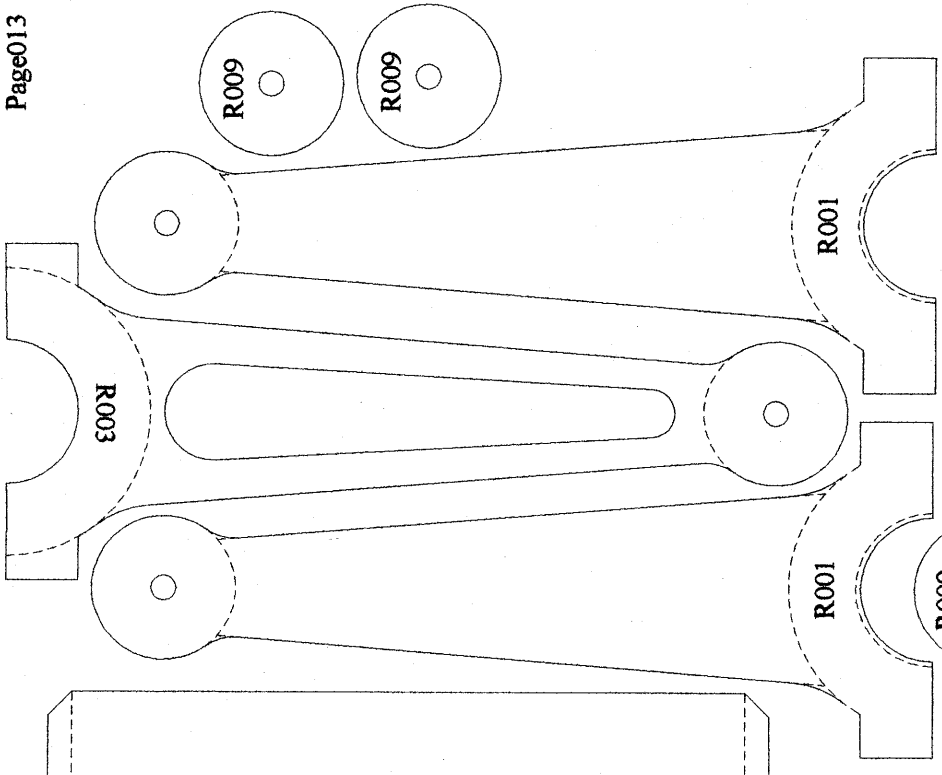

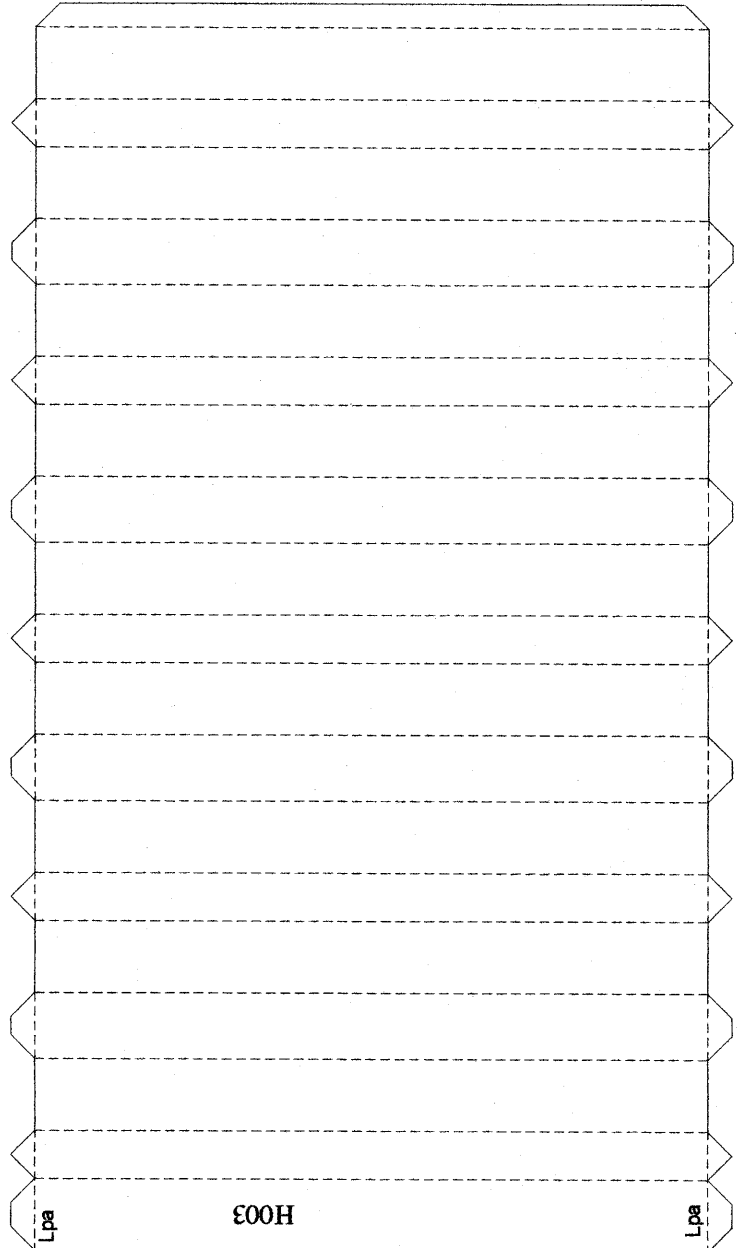
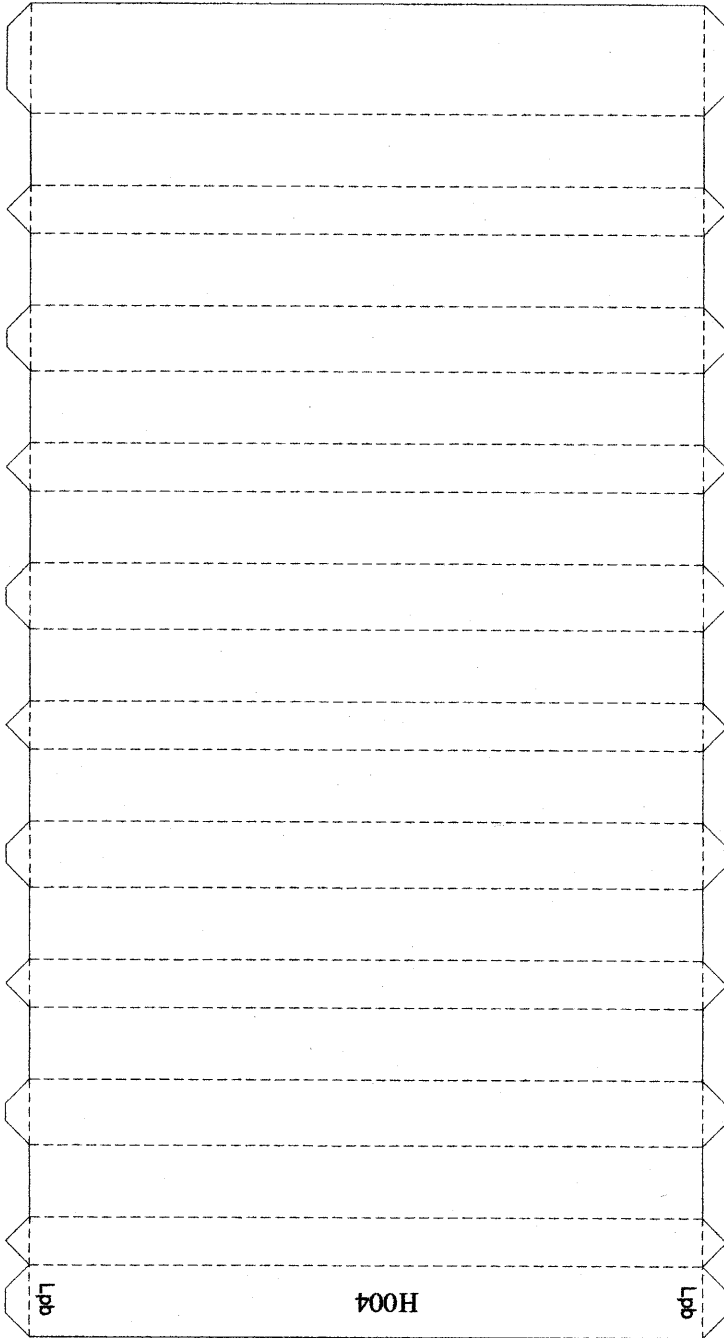
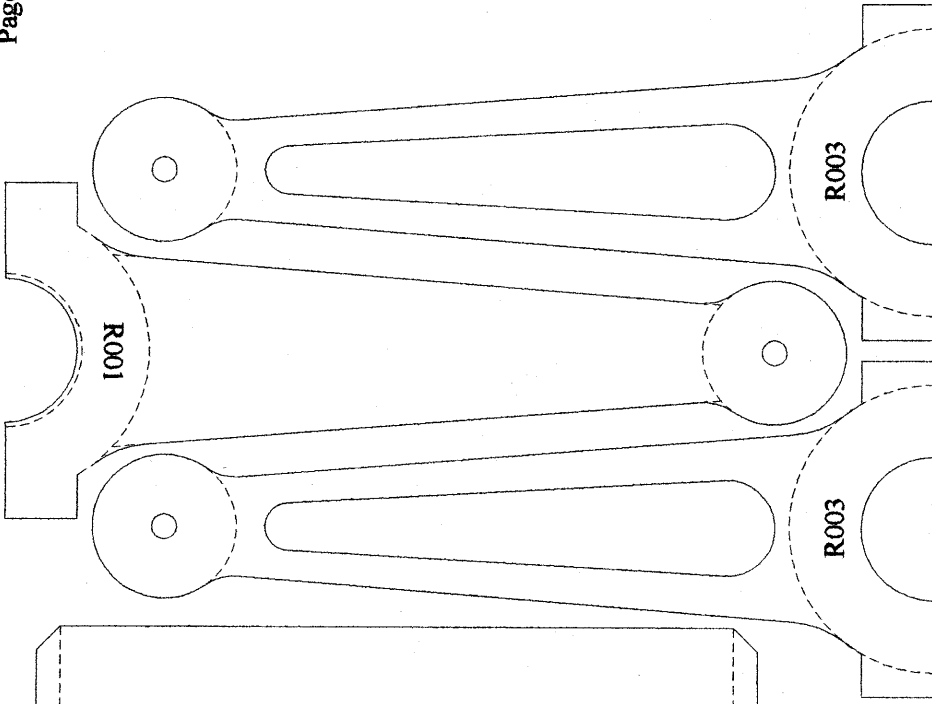

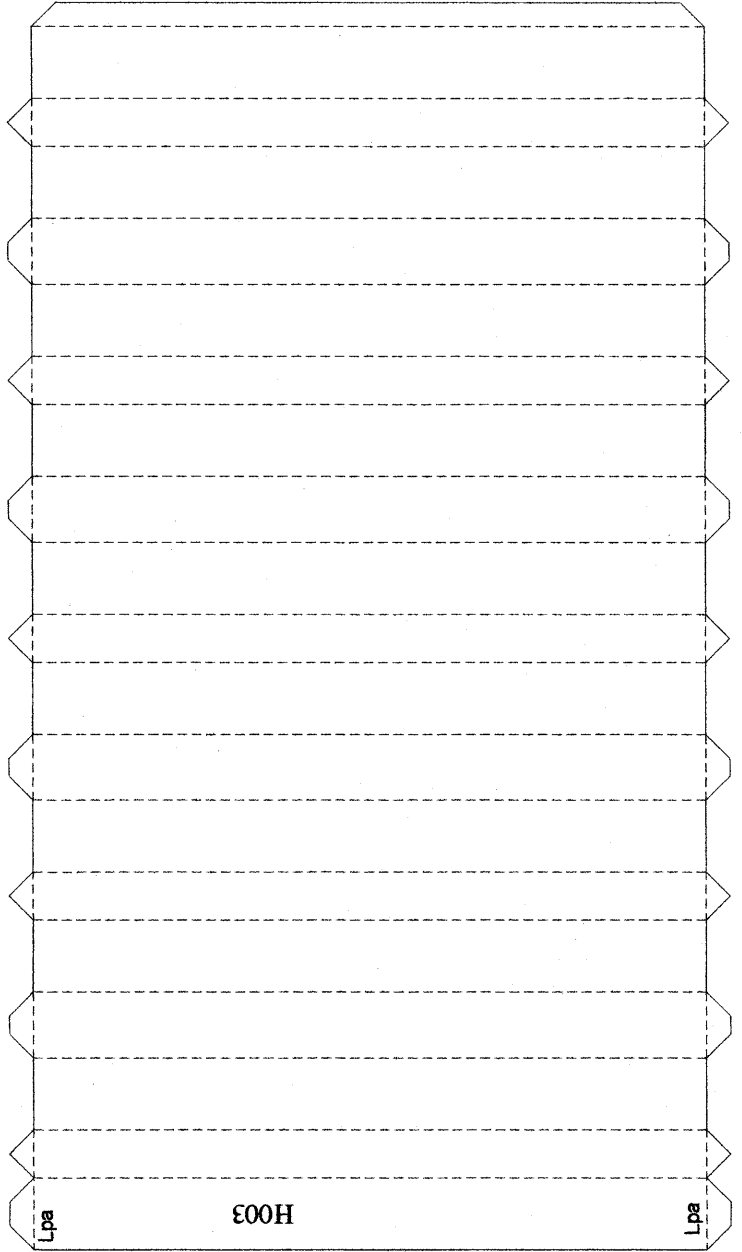
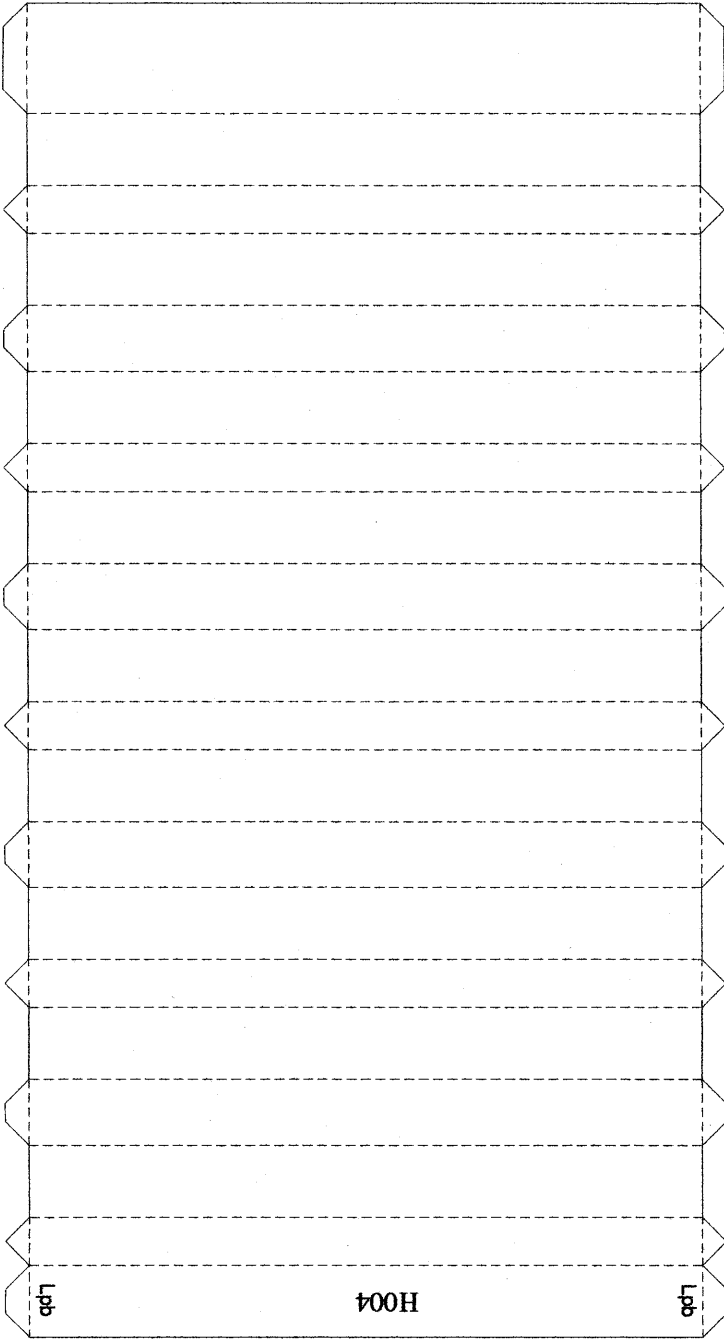
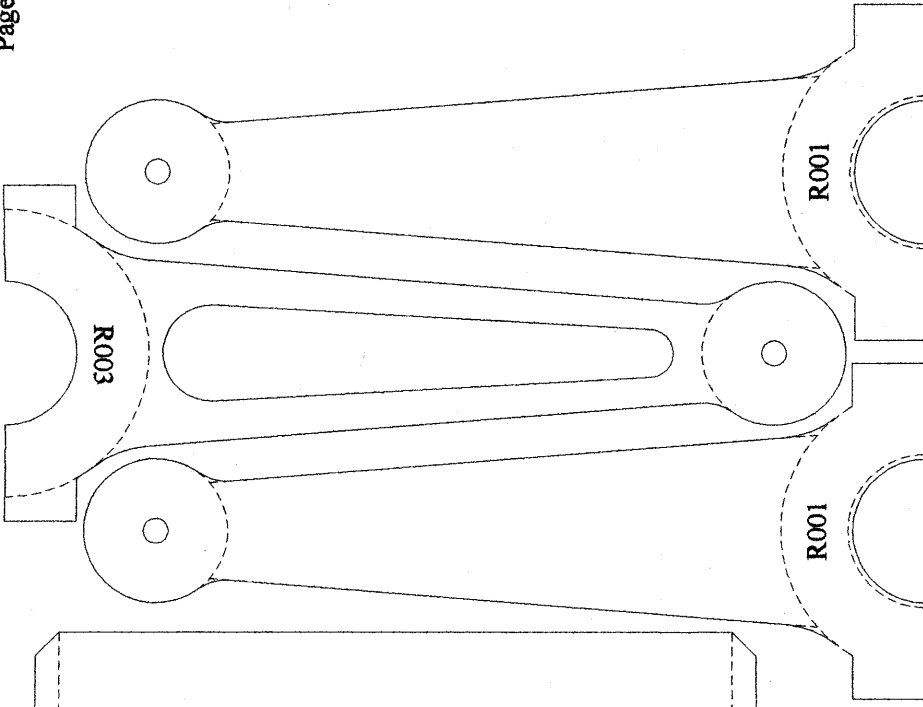

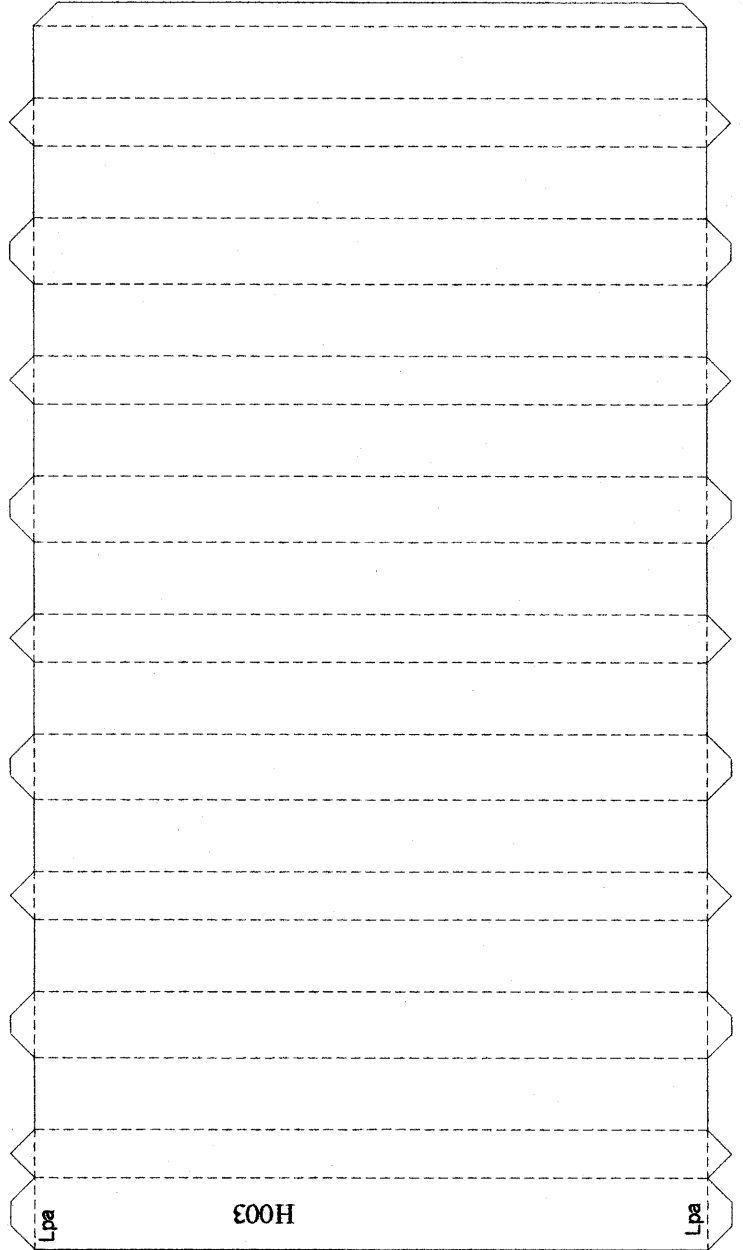
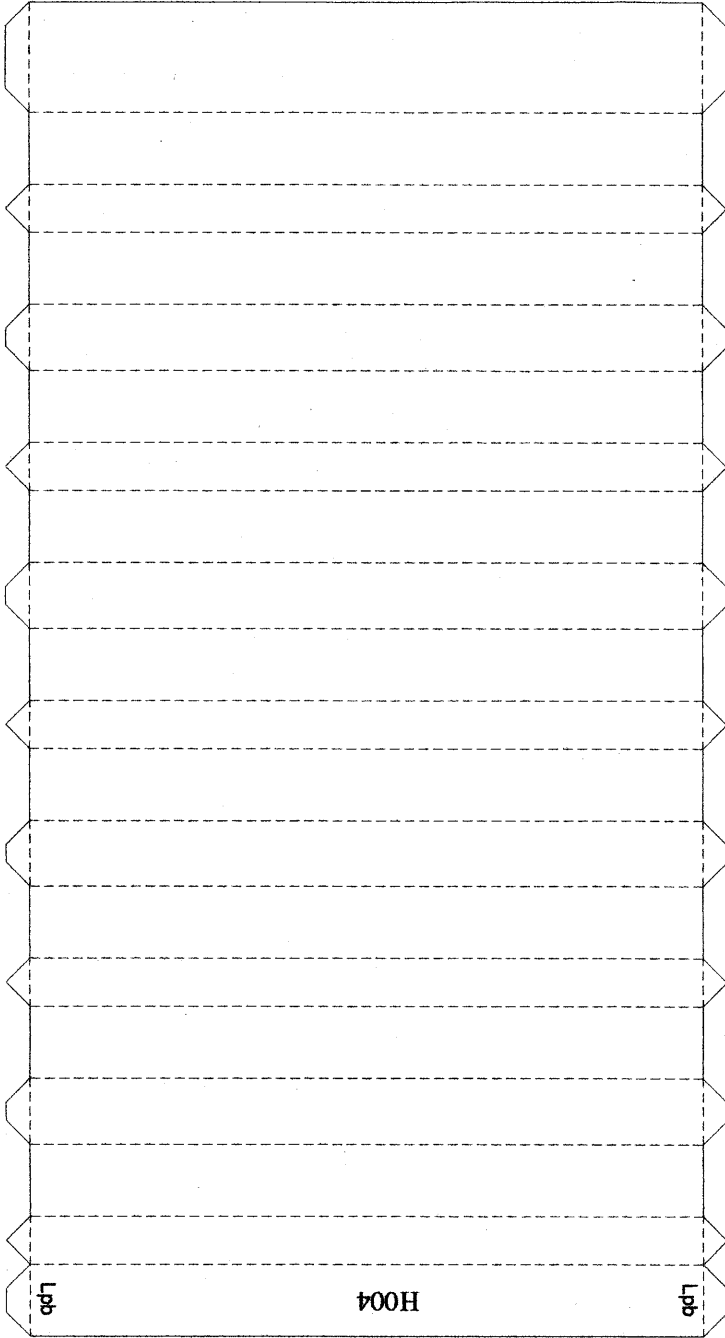
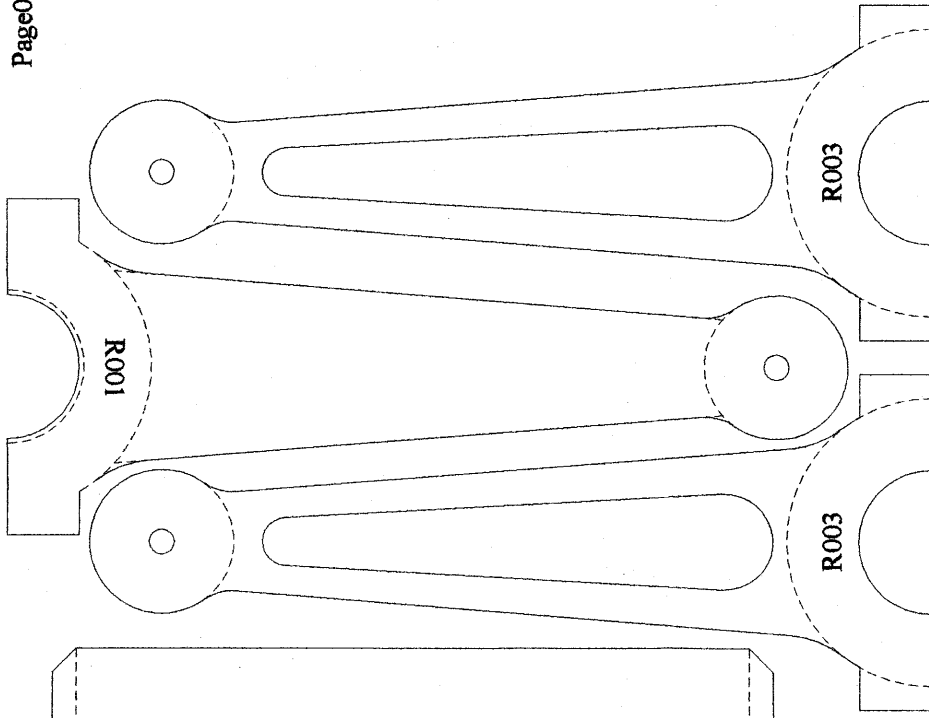

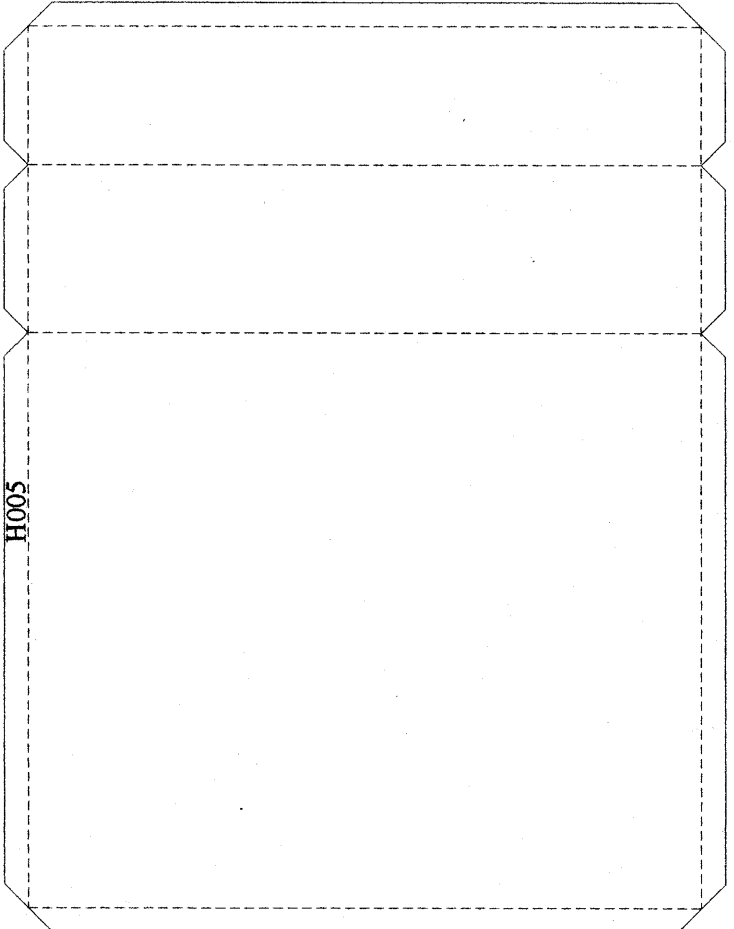
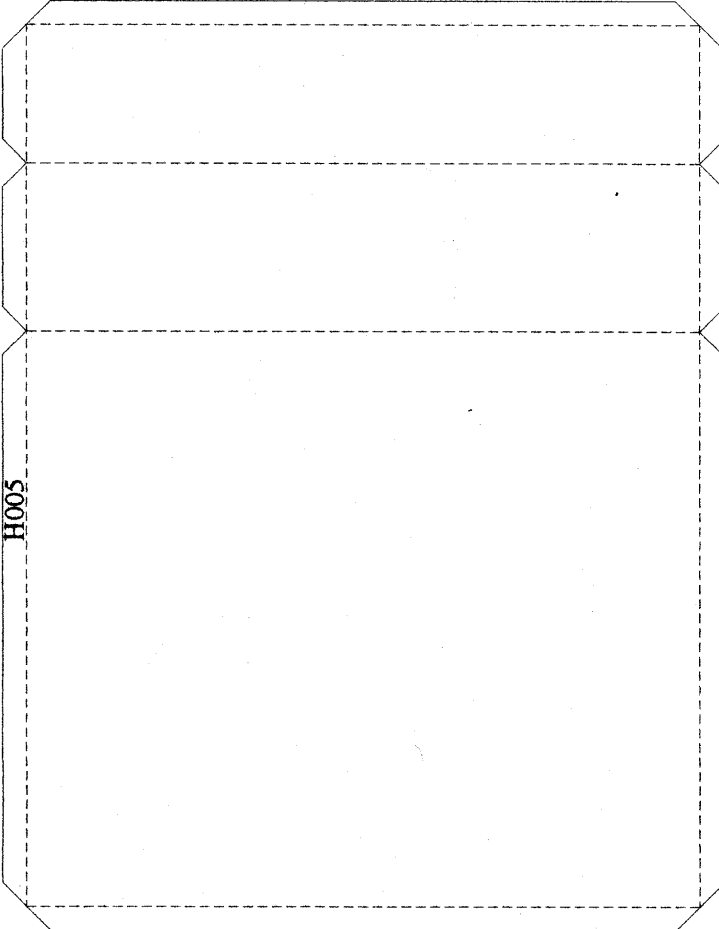
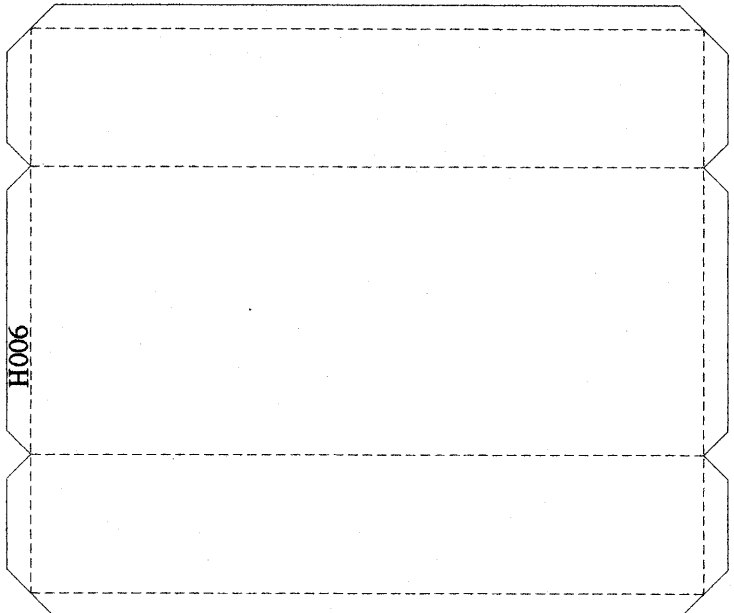
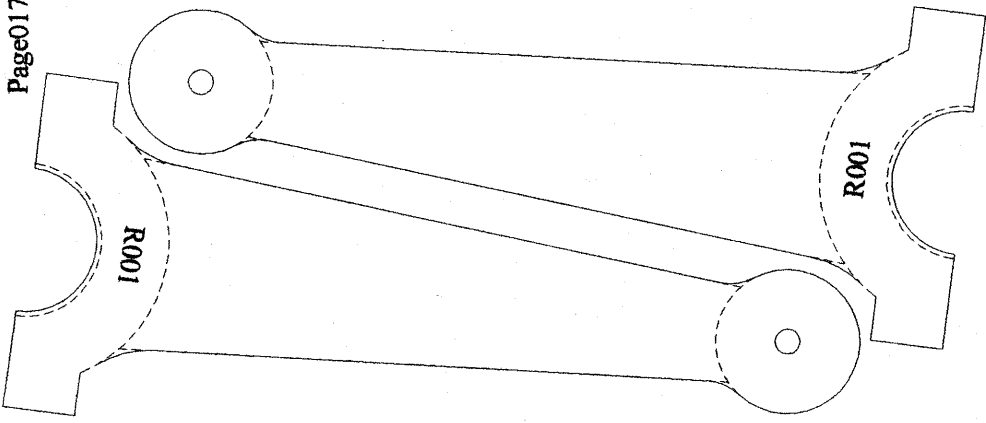

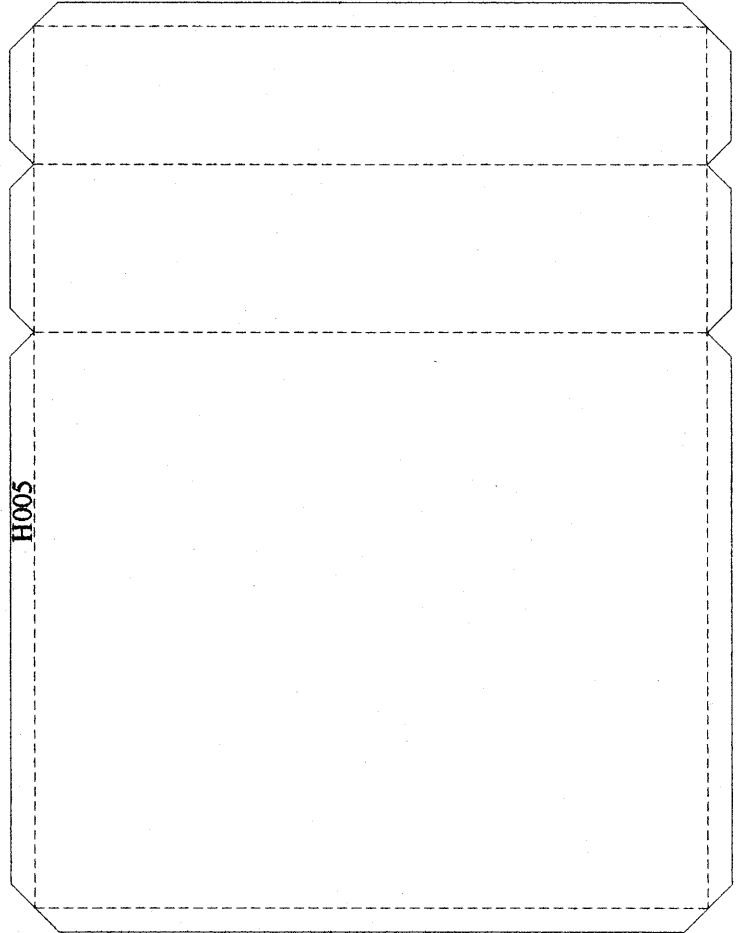
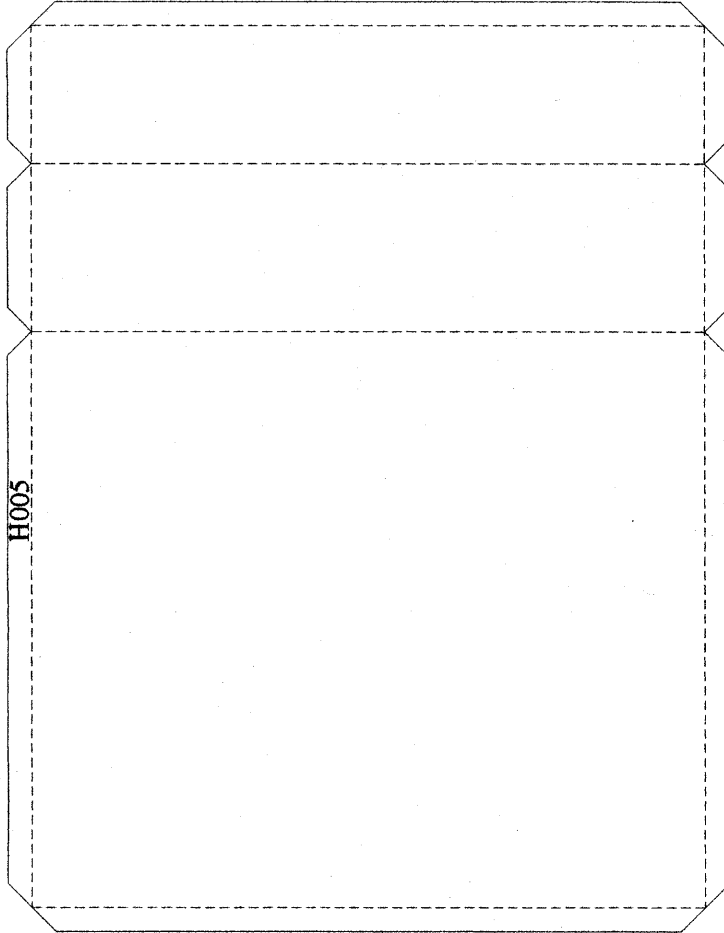
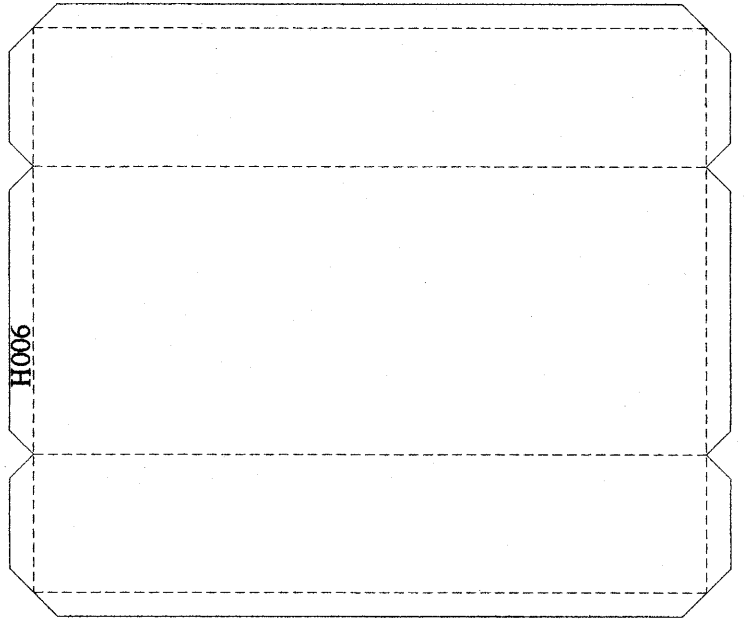
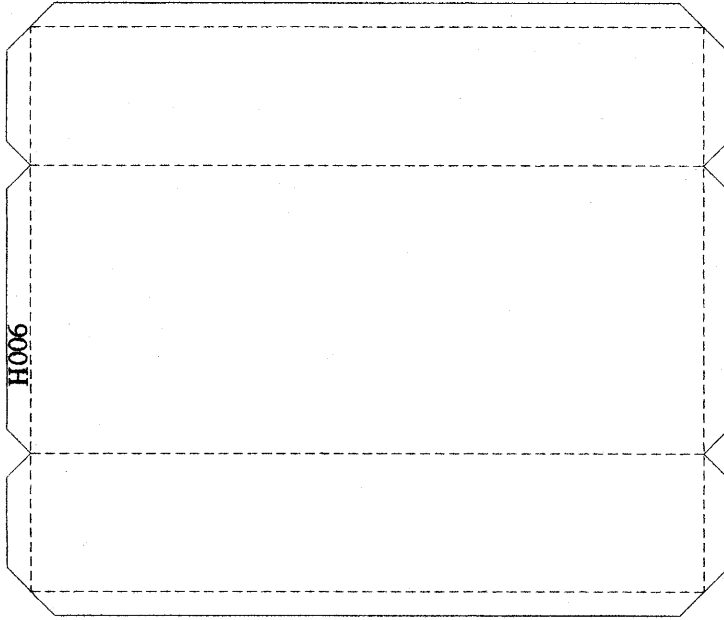
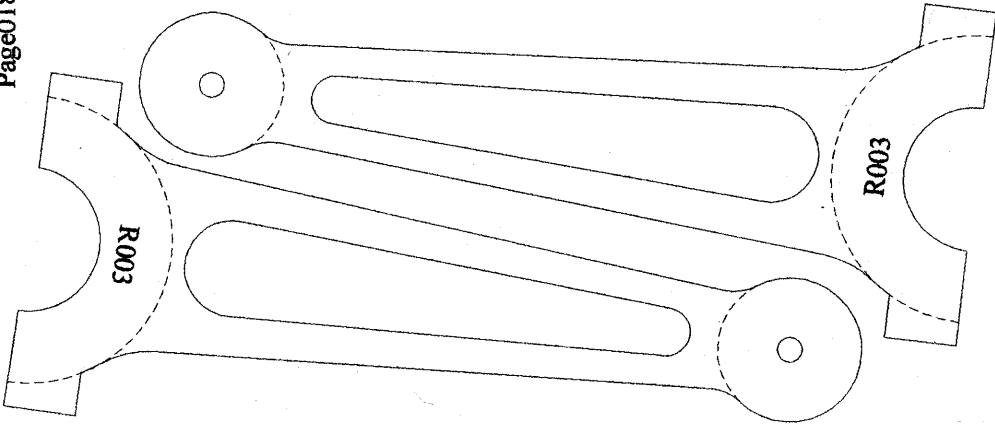

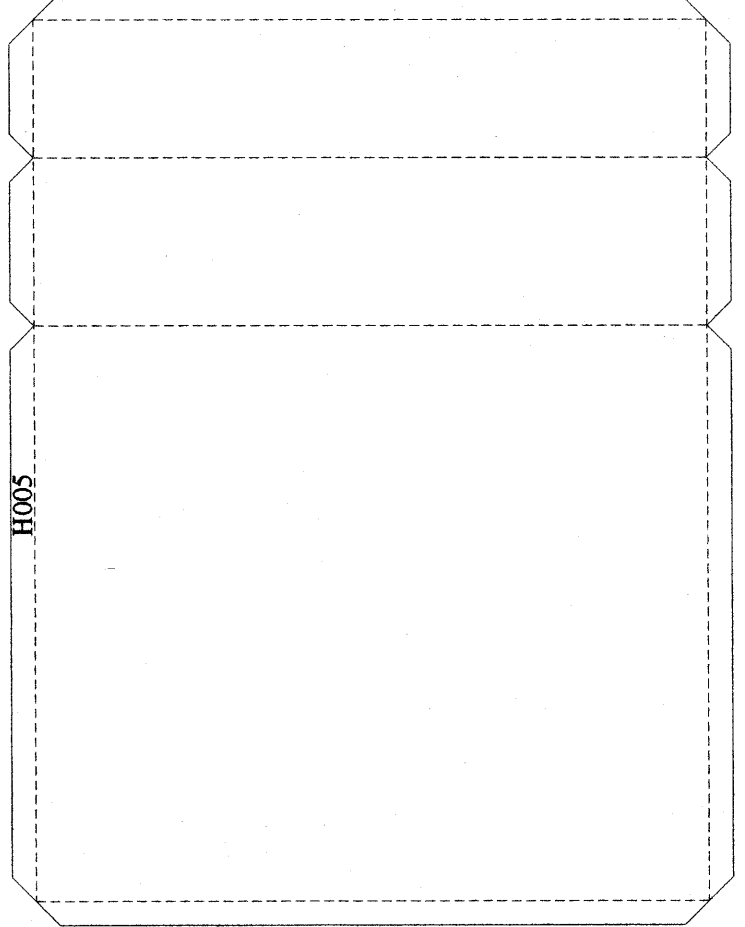
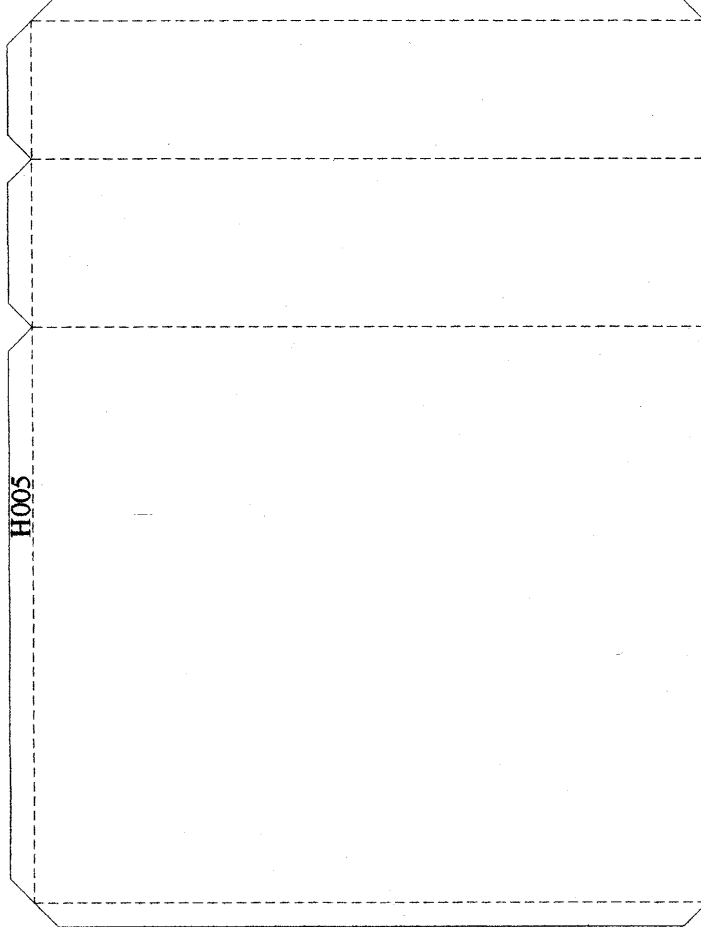
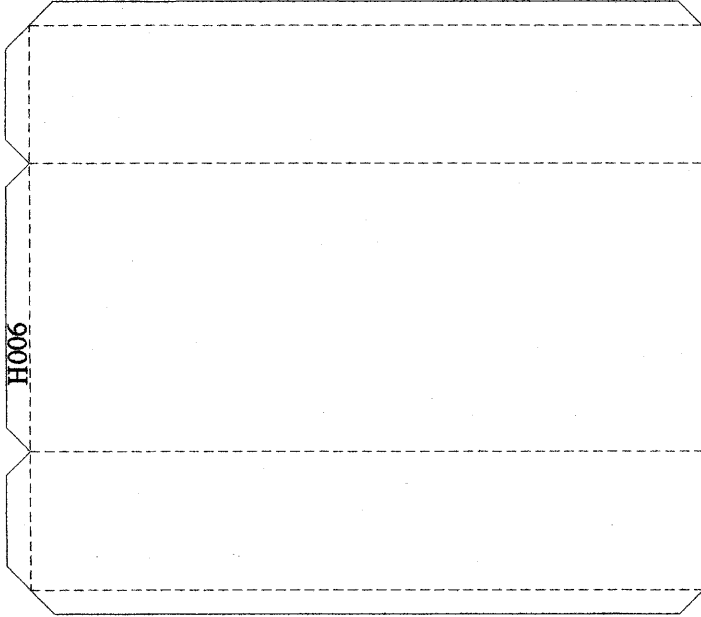
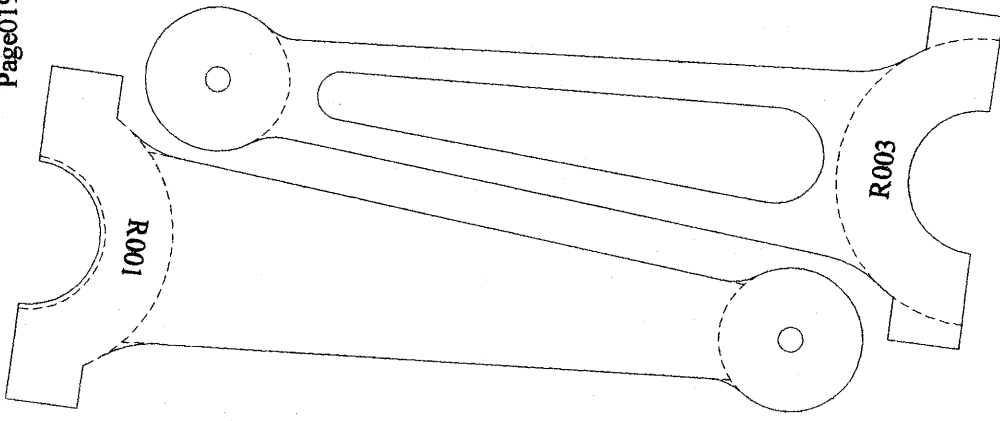



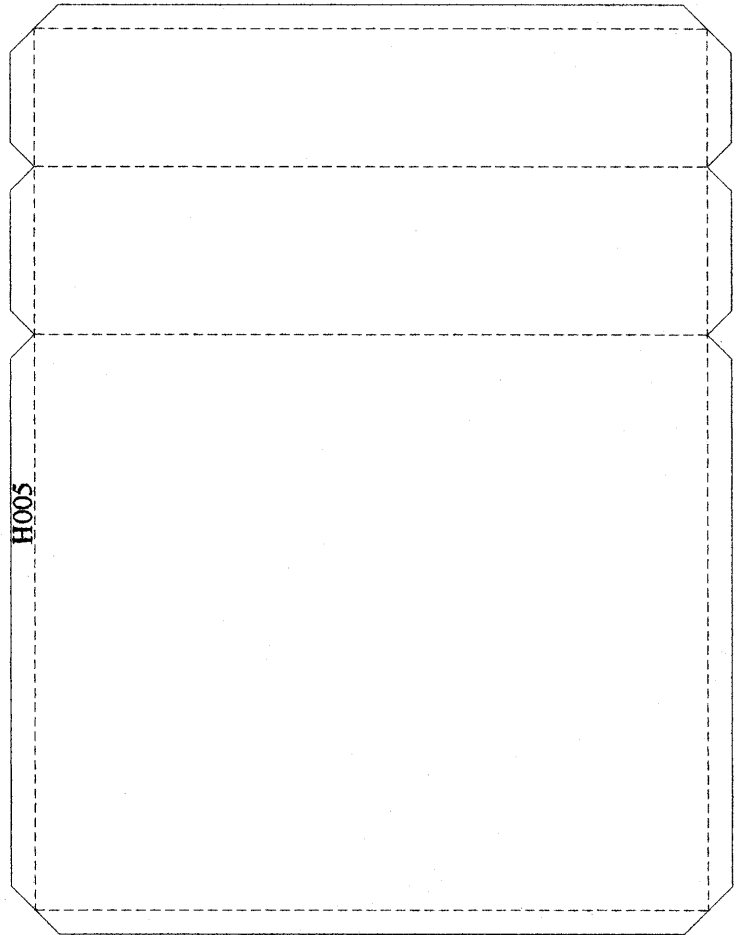
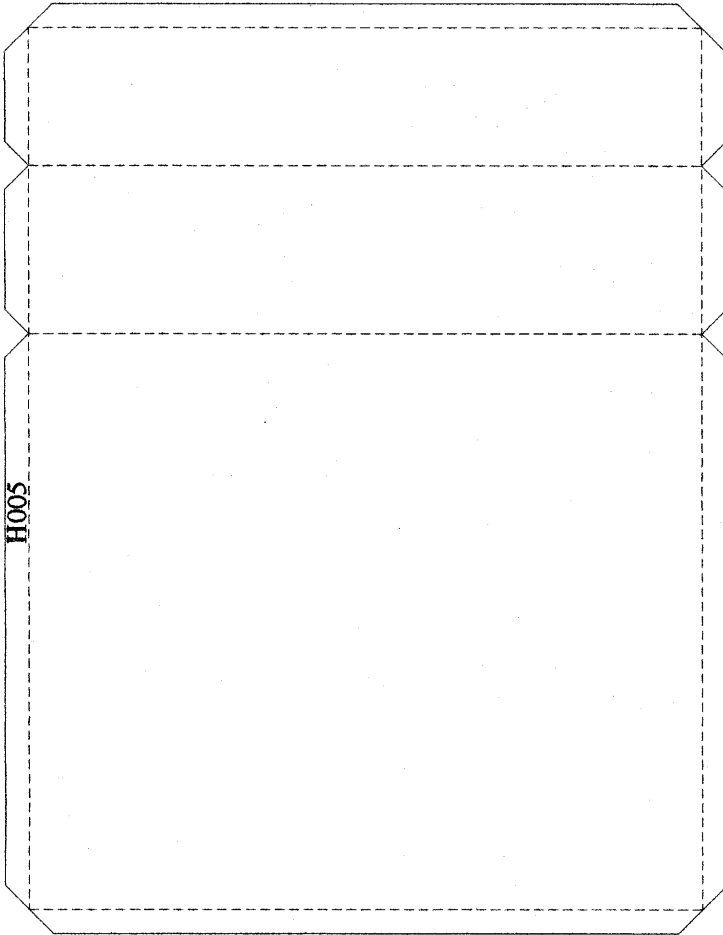
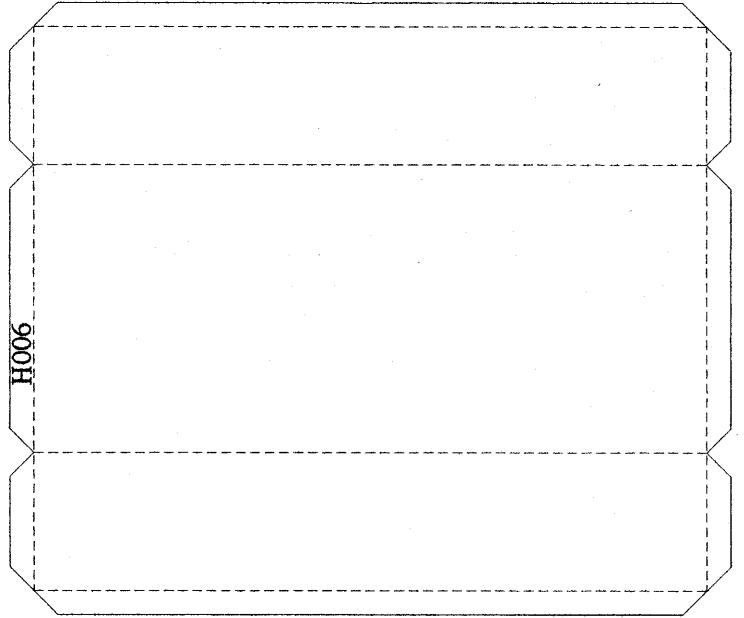
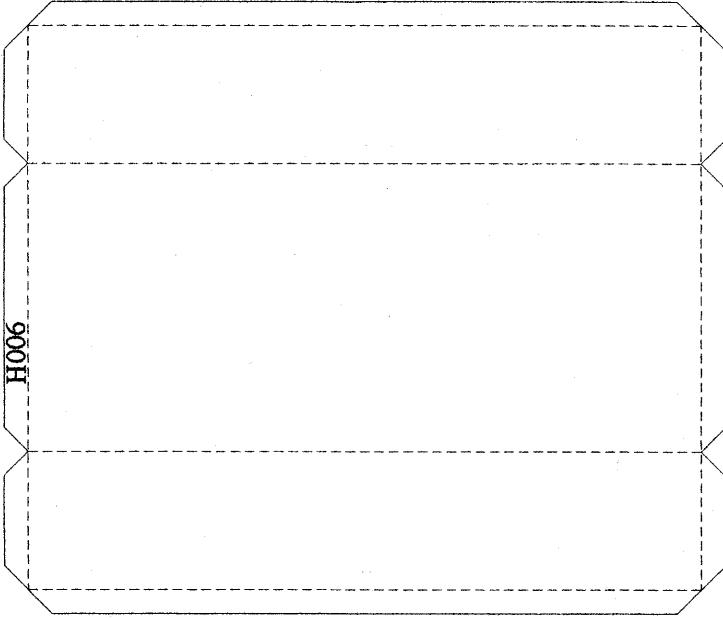
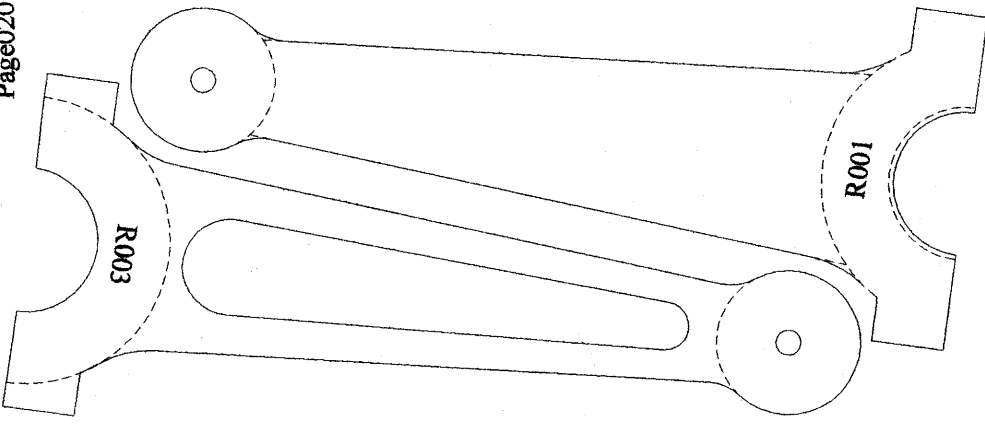

R001

R003

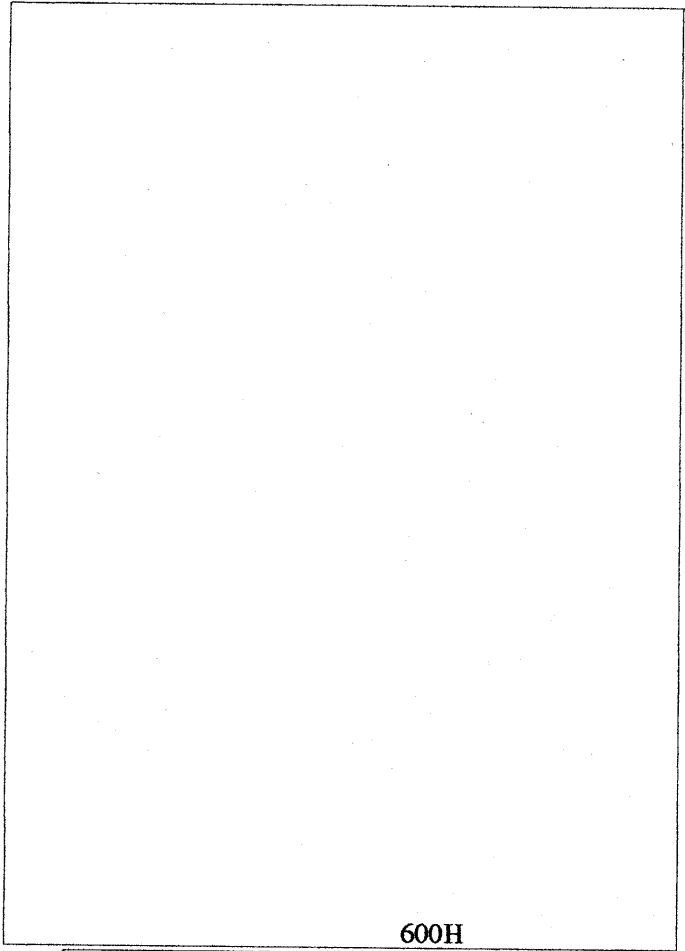

H009

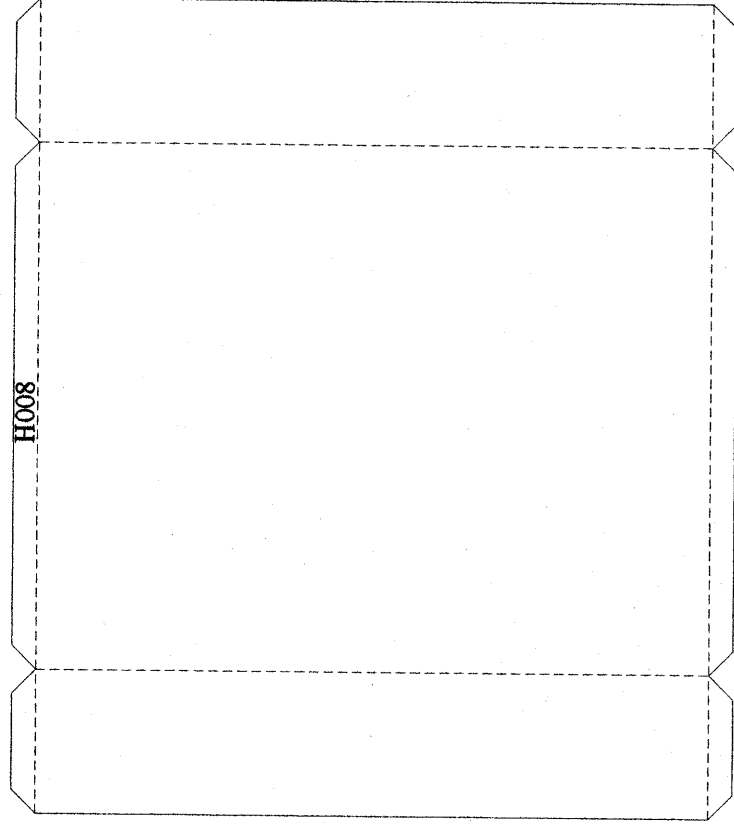

H008

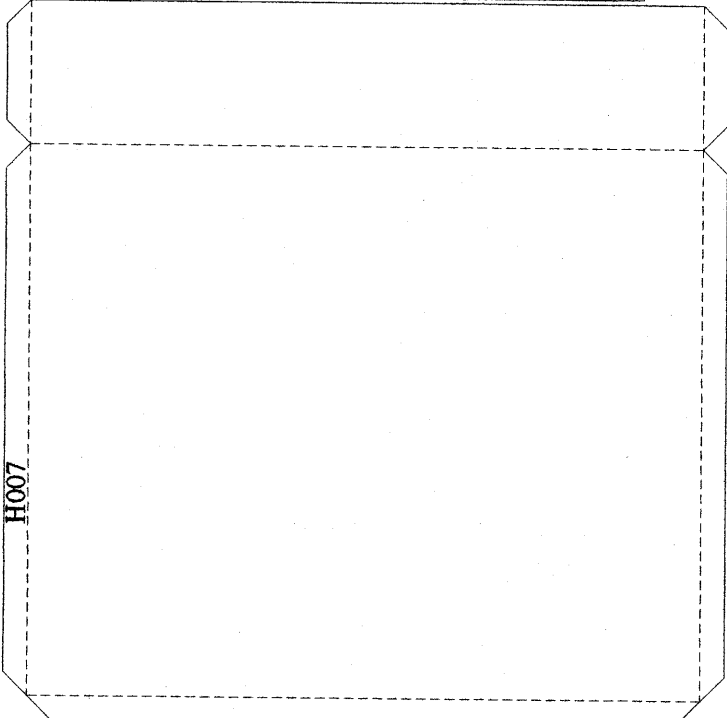

H007

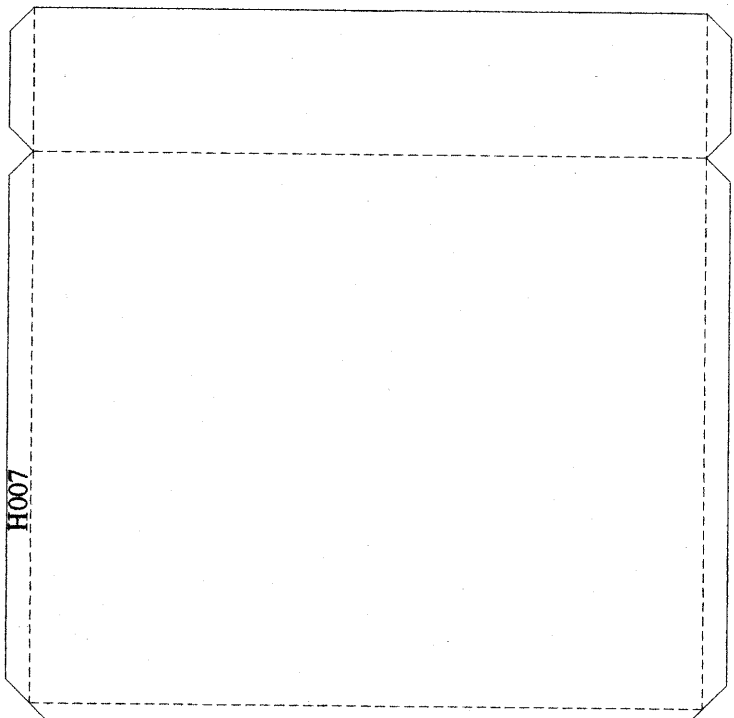

H007

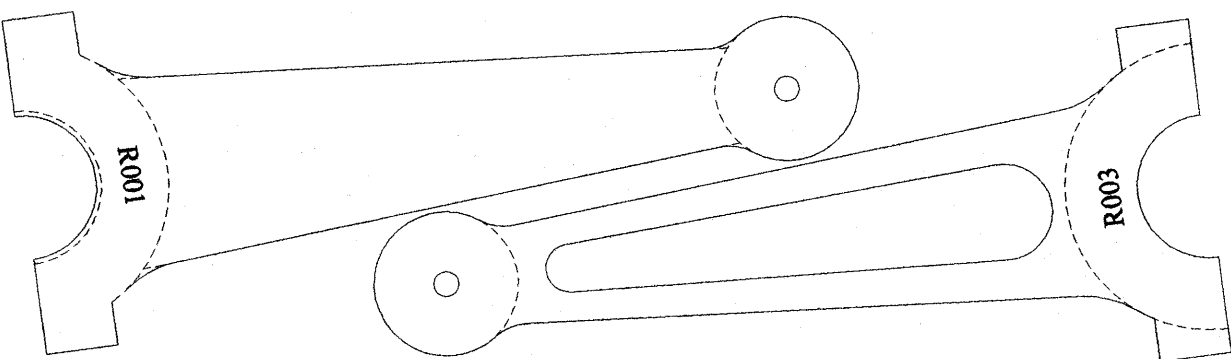

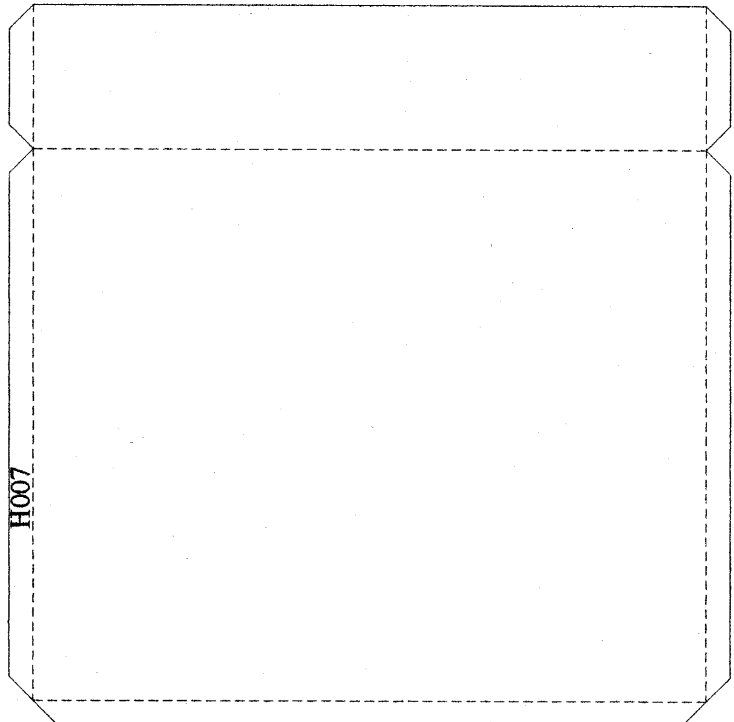
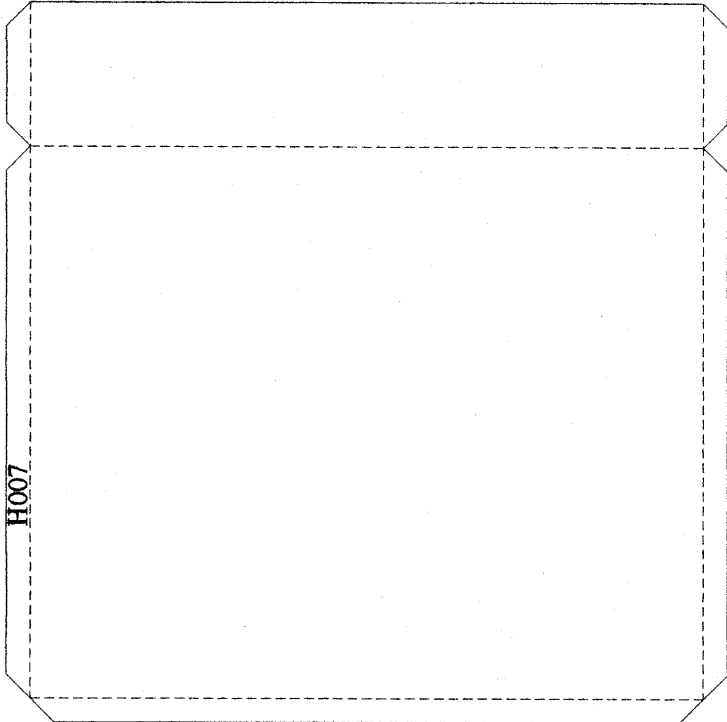
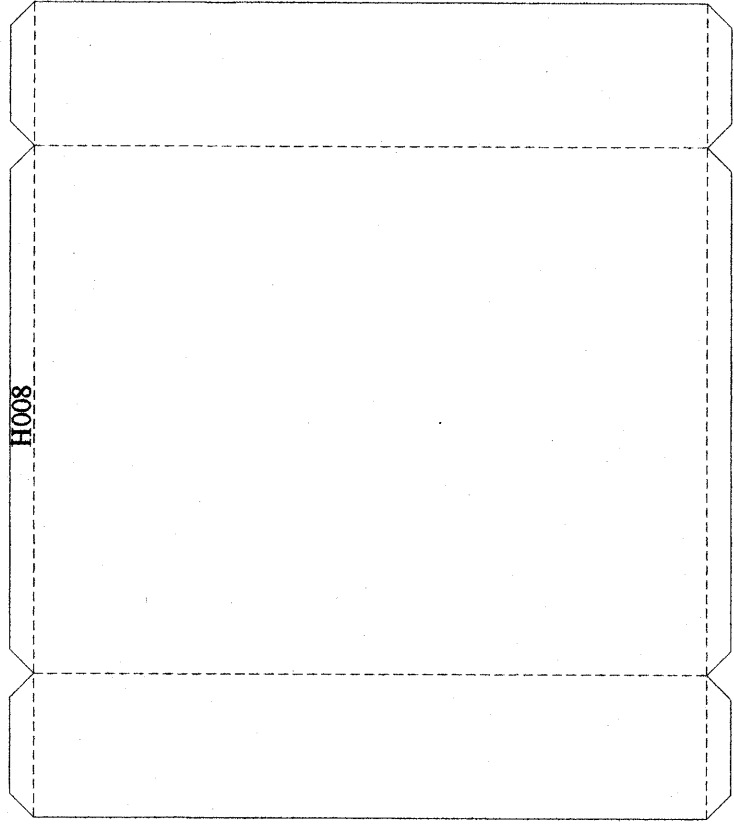
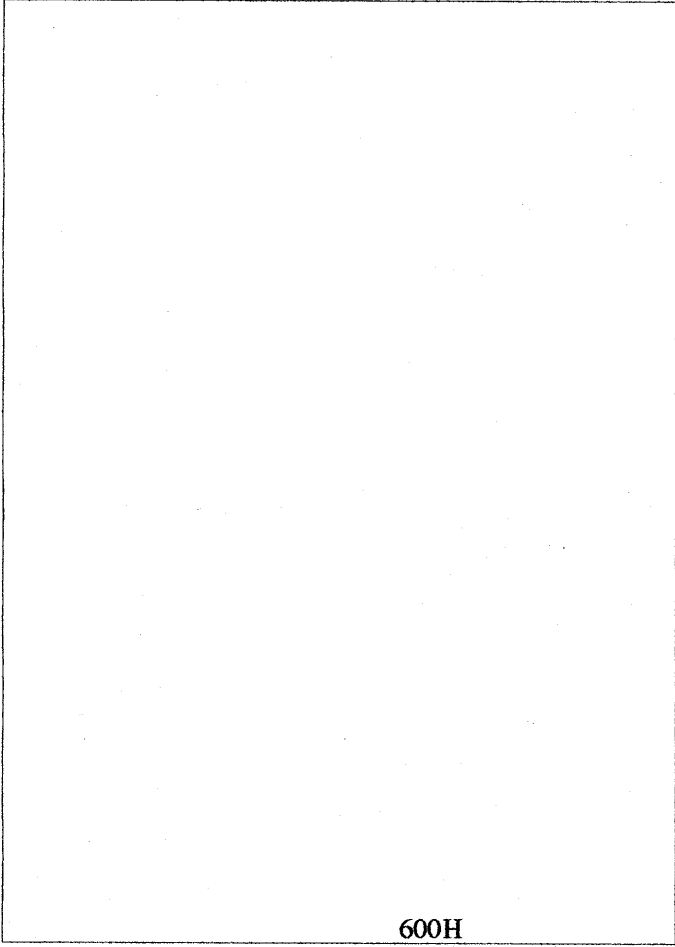
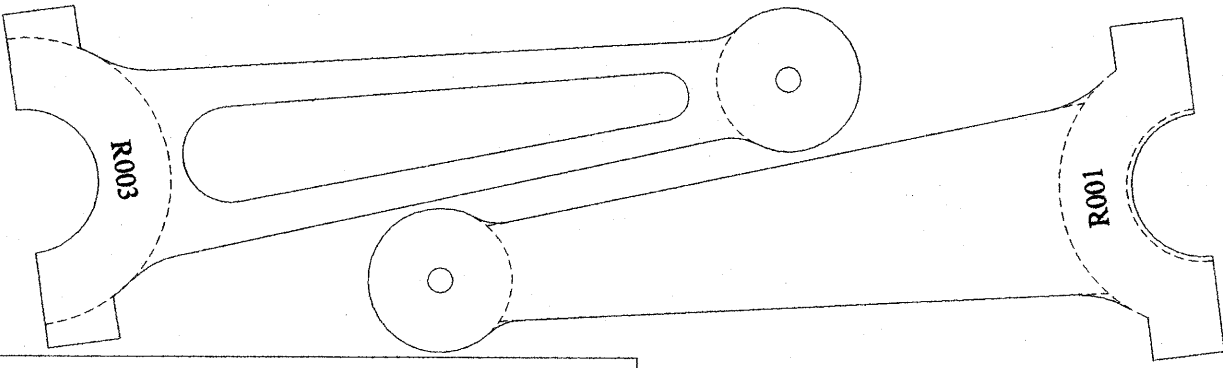

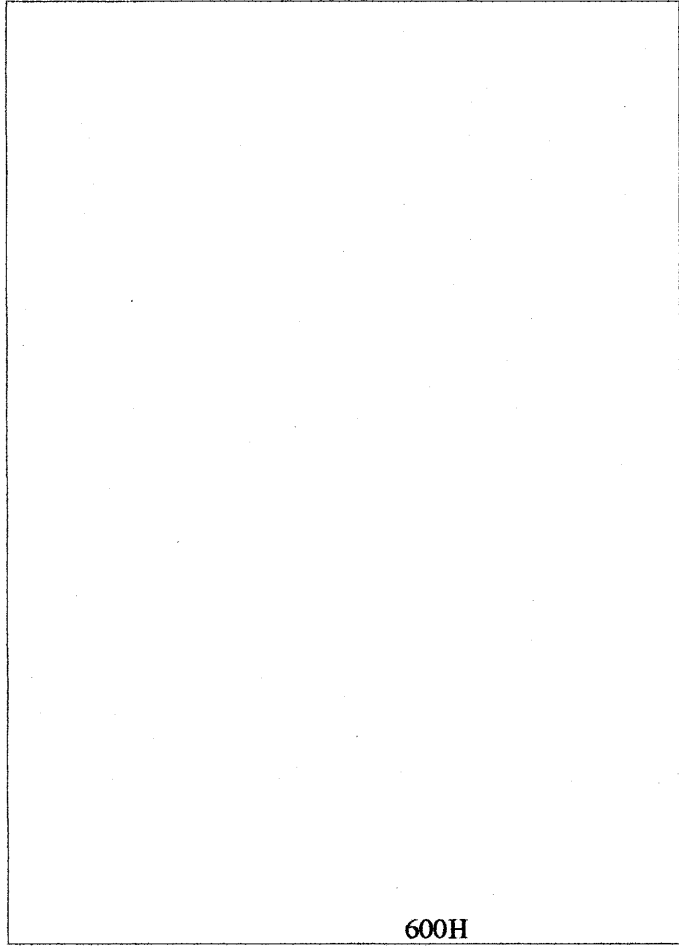

600H

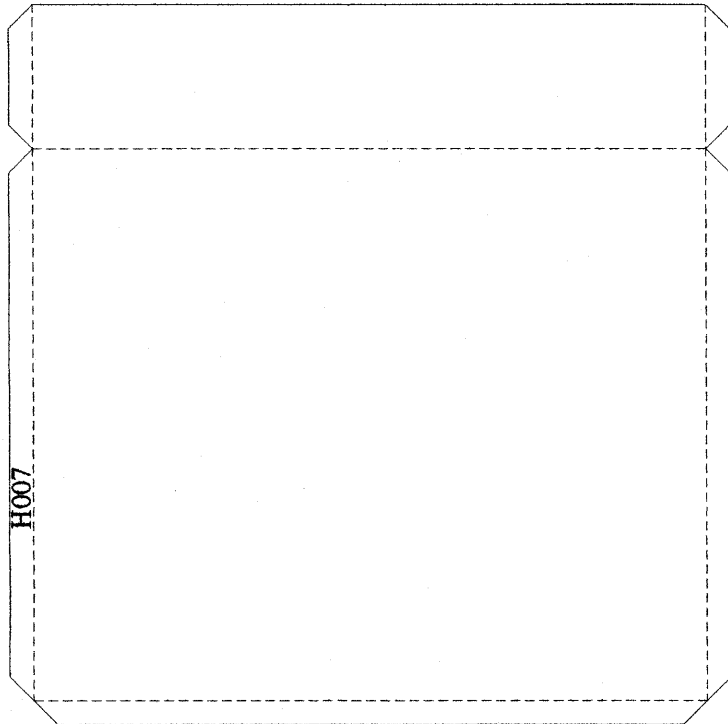

H007

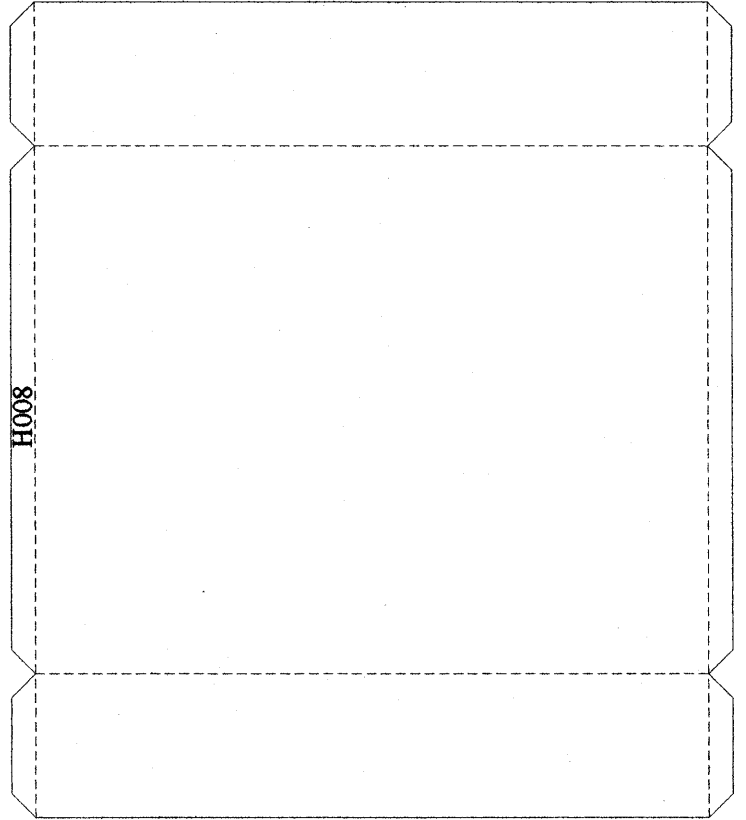

H008

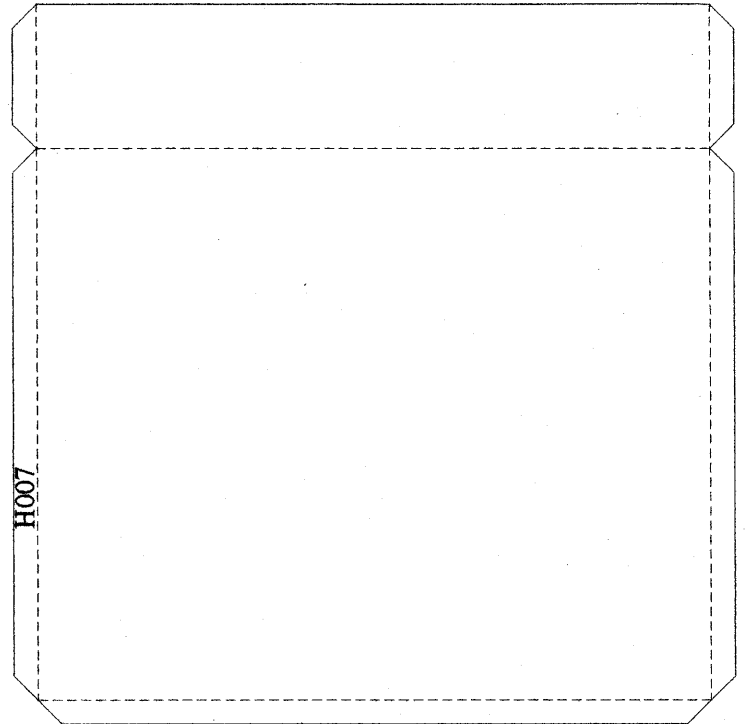

H007

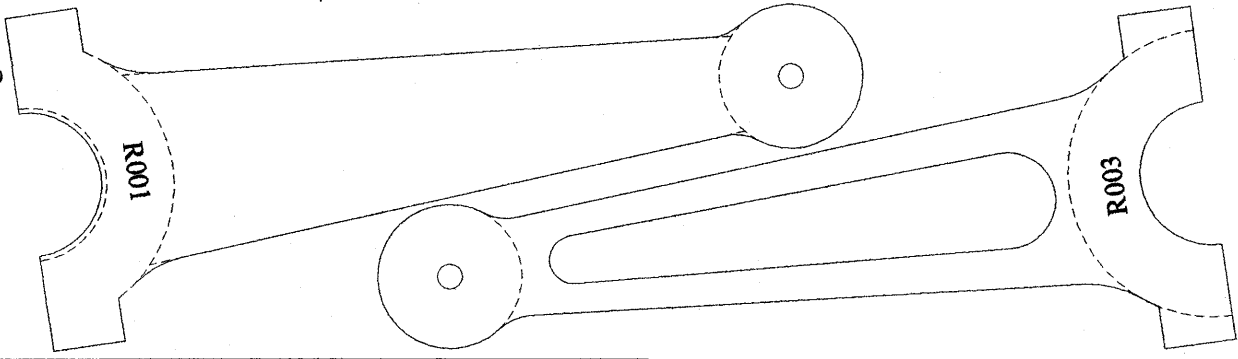

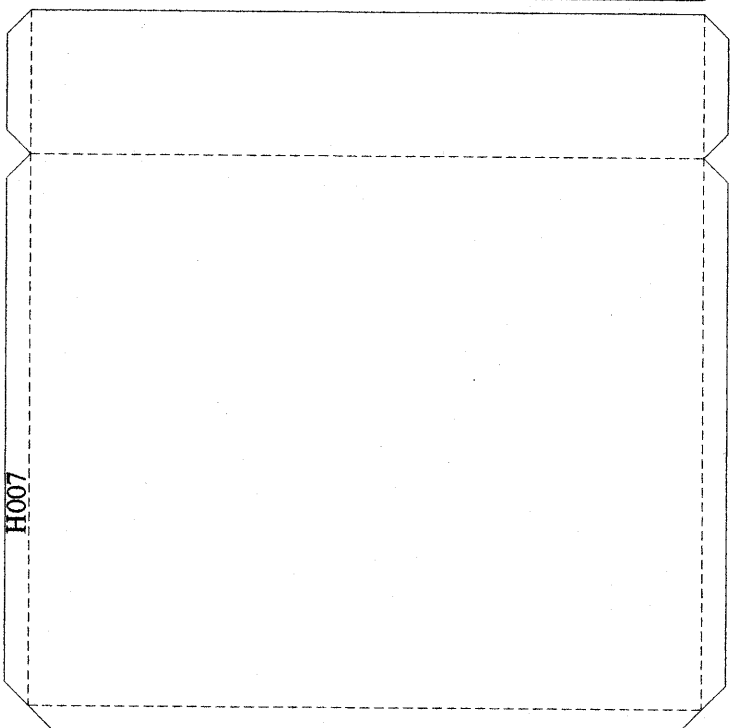
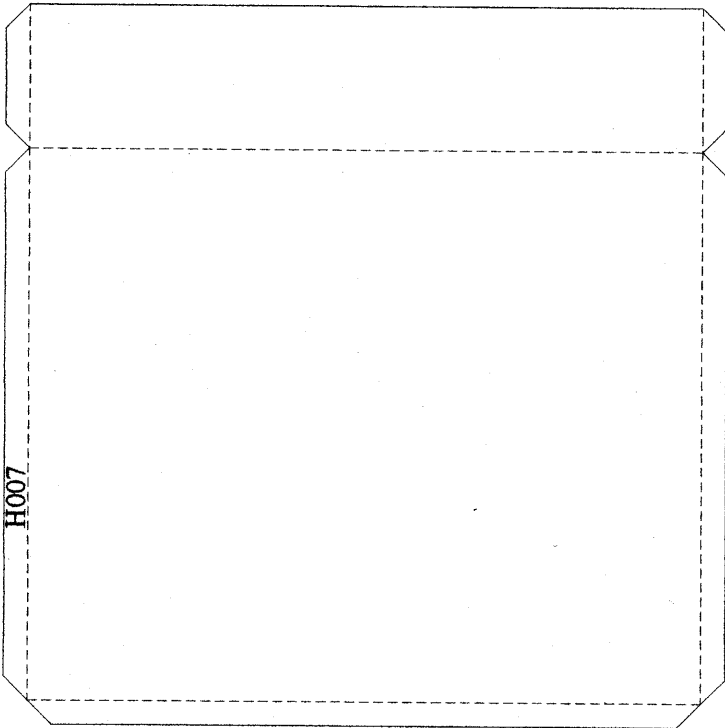
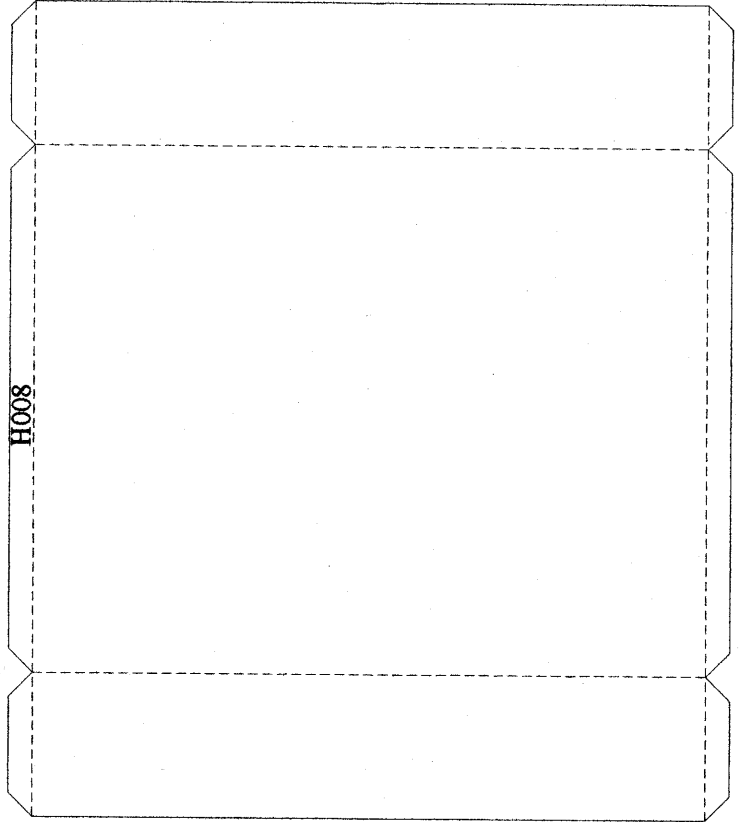
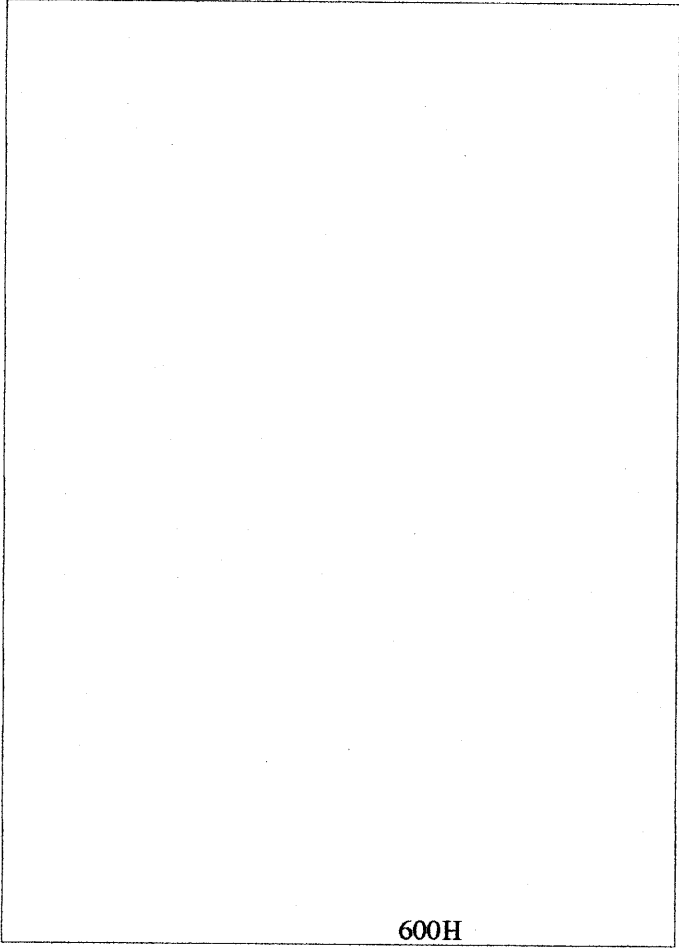
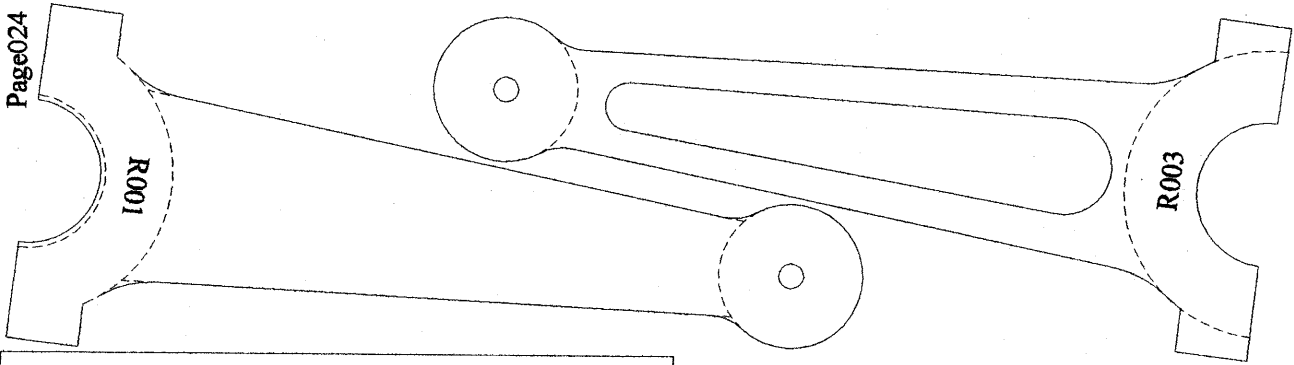

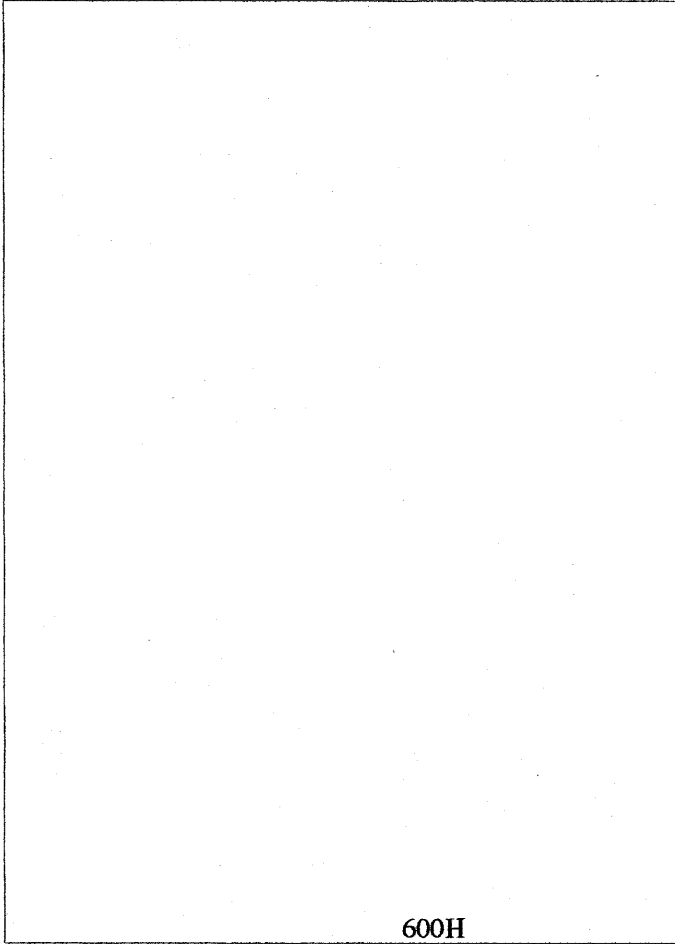
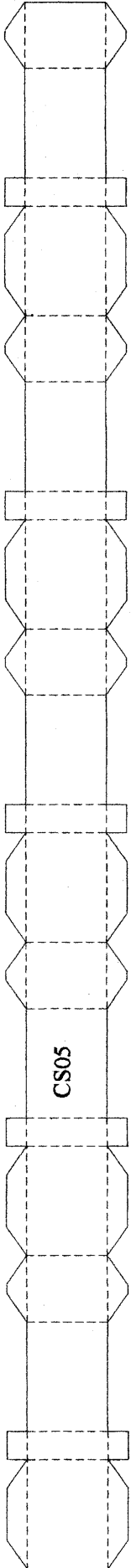

600H

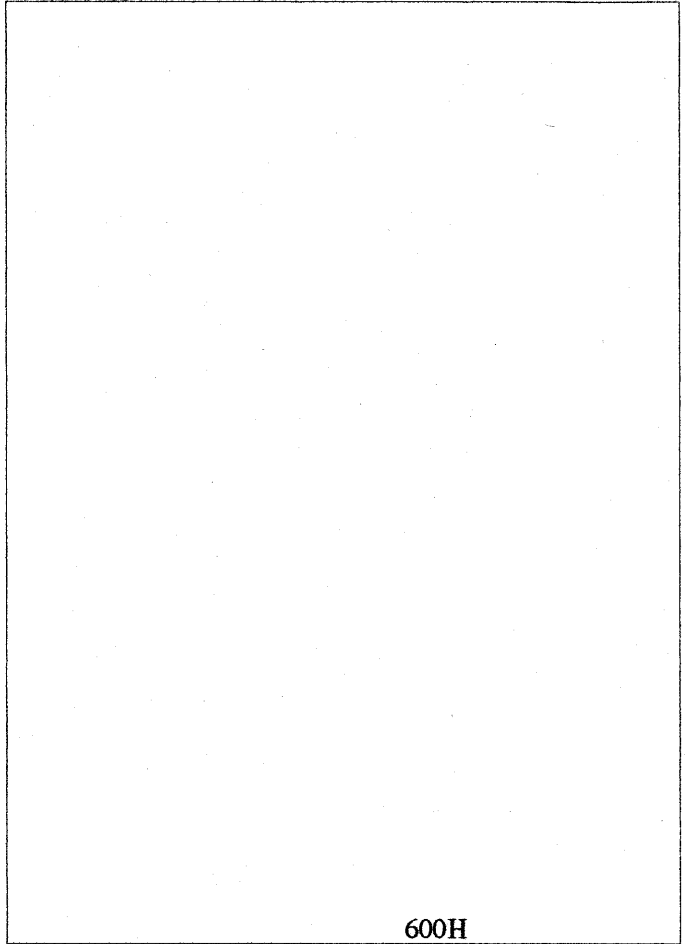

600H

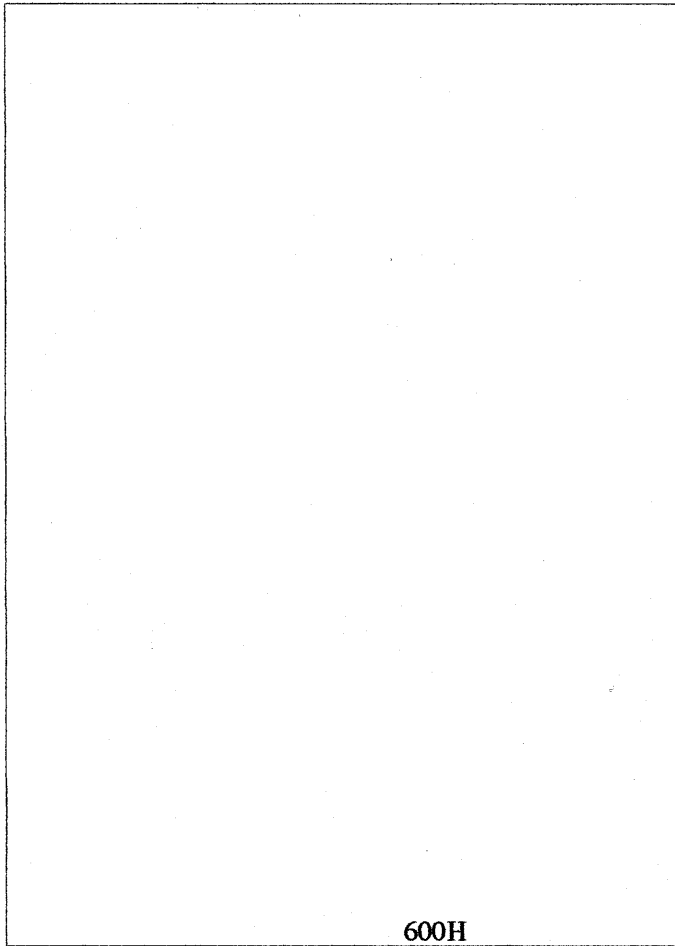

600H

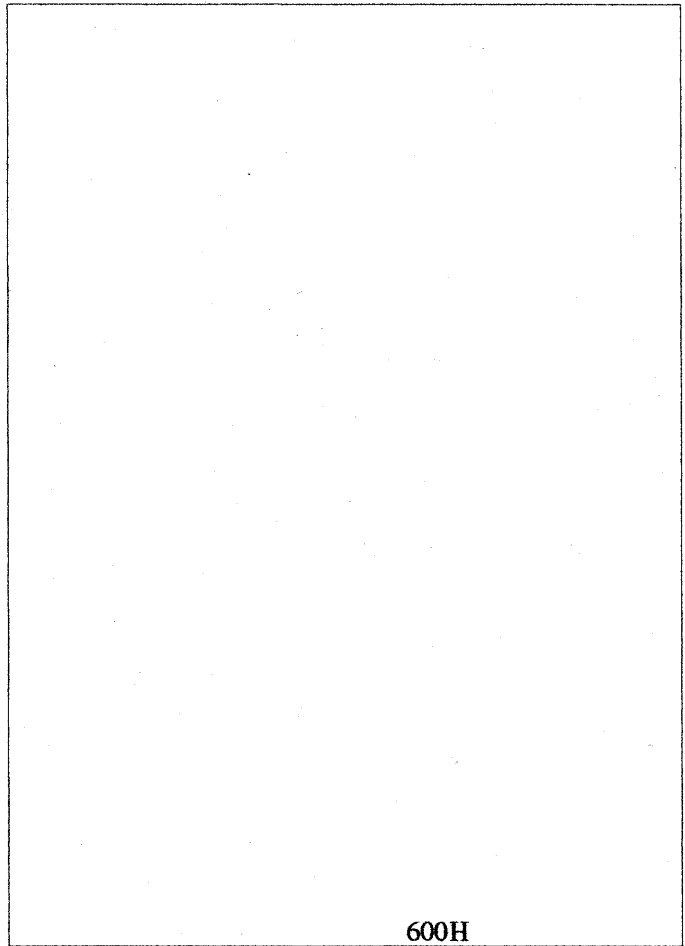

600H

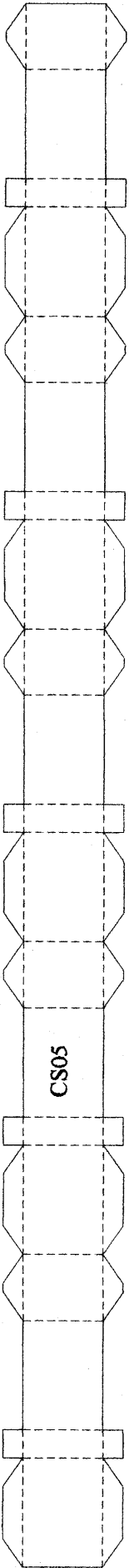

CS05

600H

600H

600H

600H

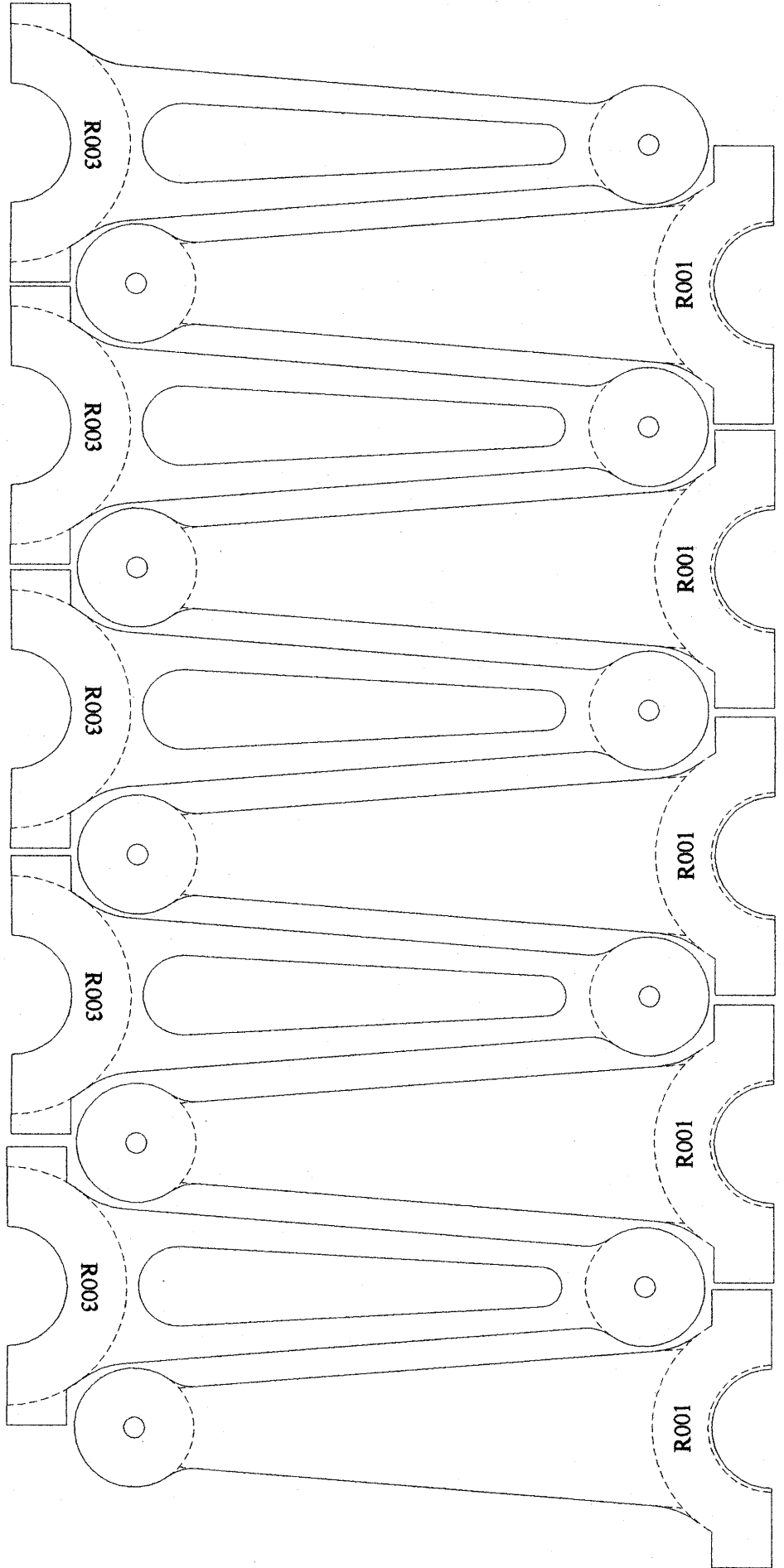
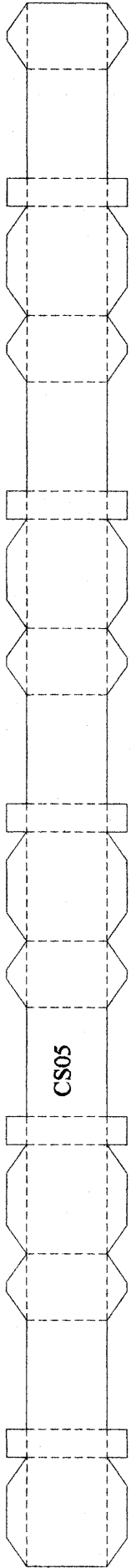
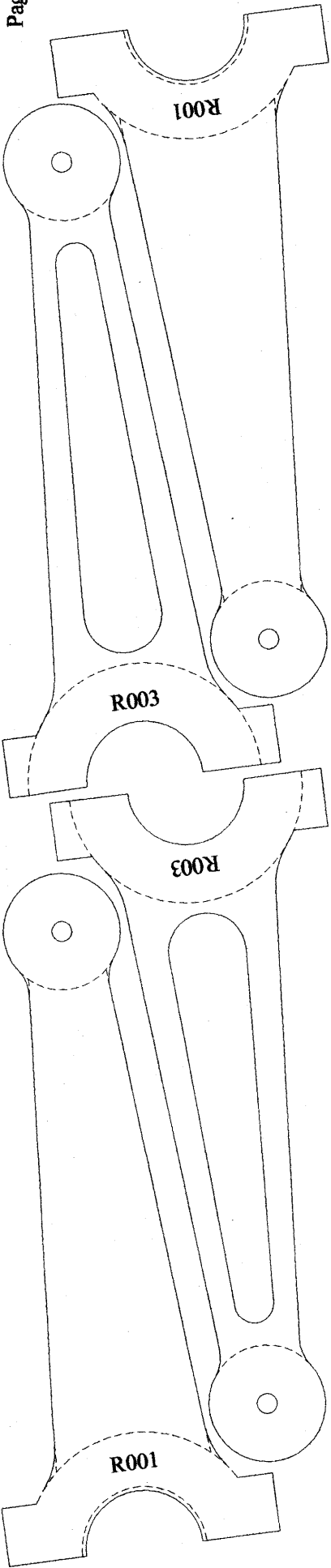



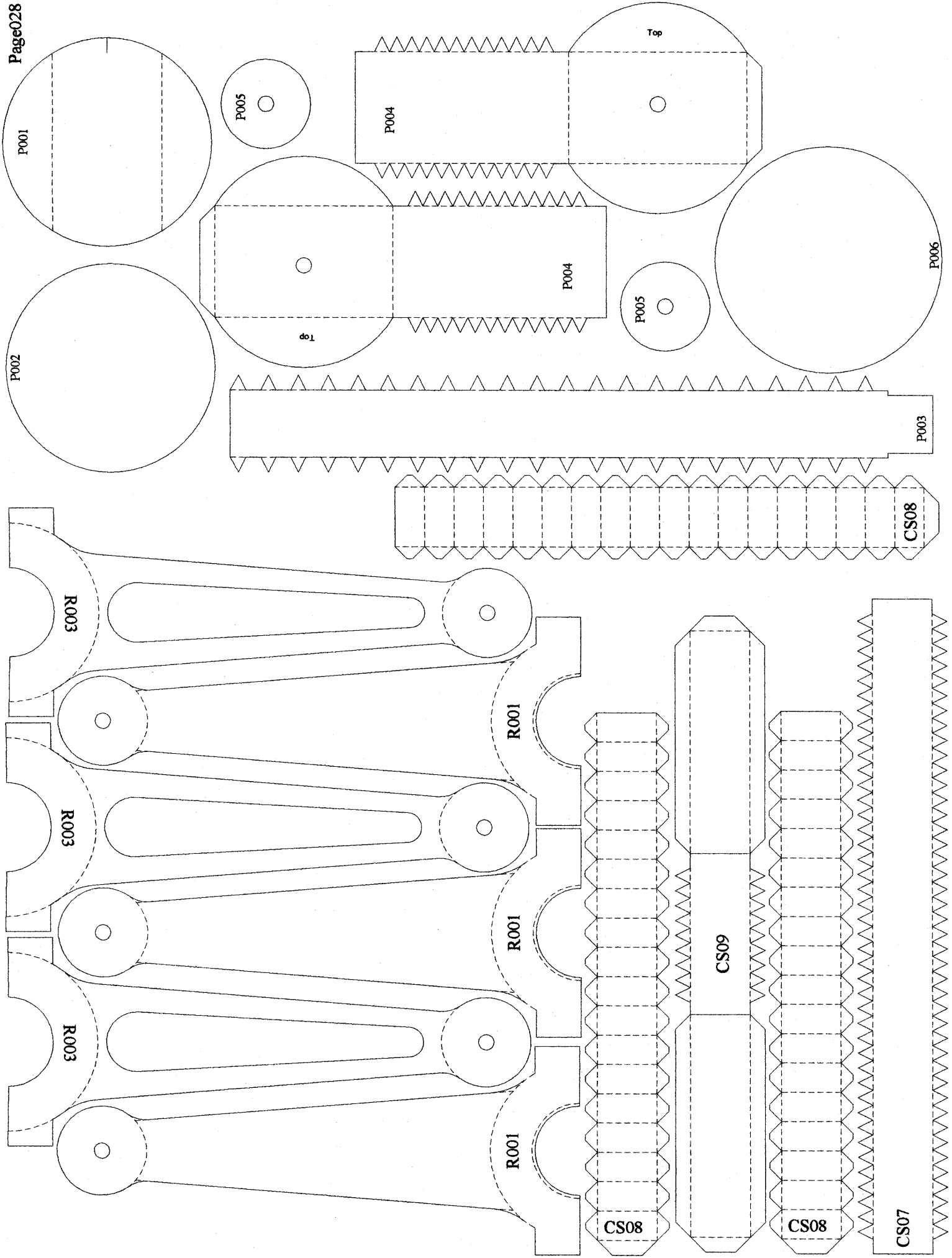

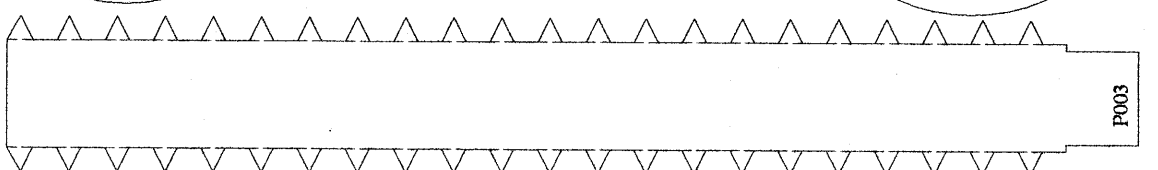
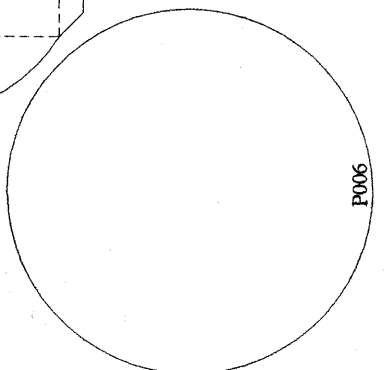
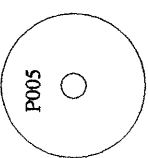
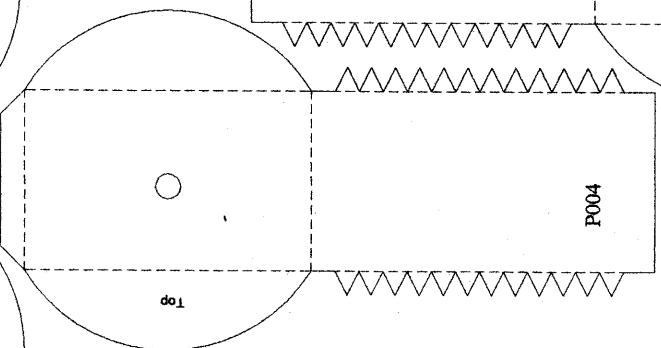
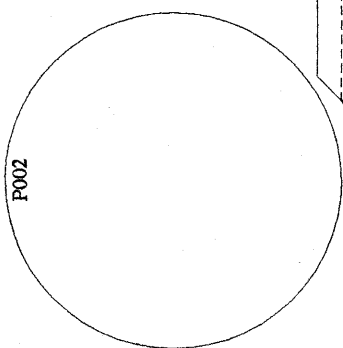
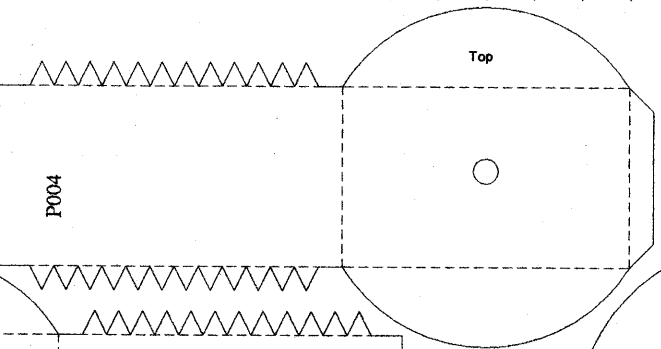
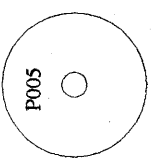
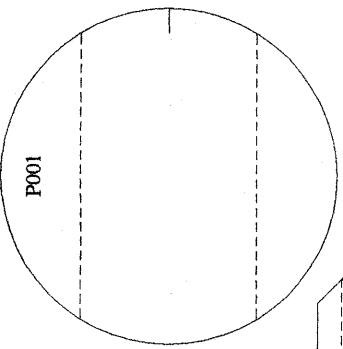
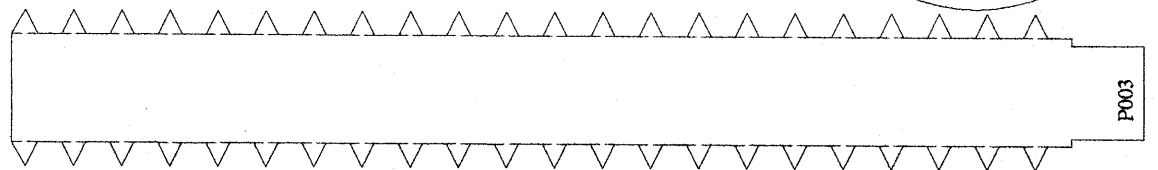
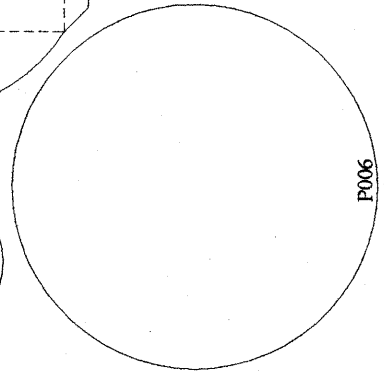
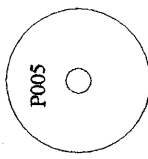
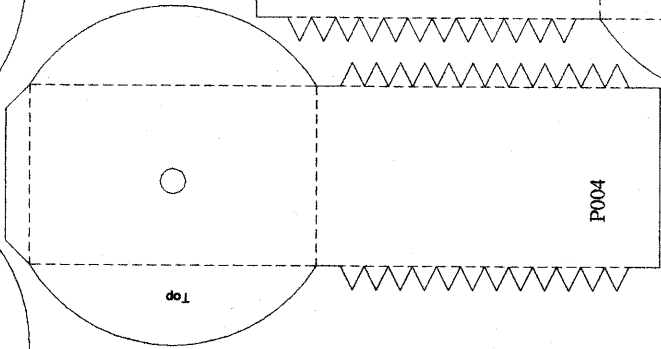
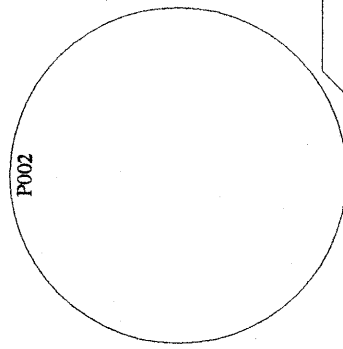
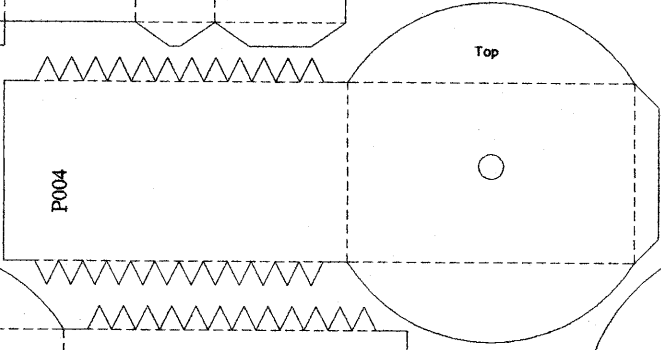
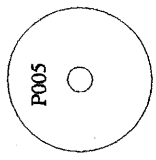
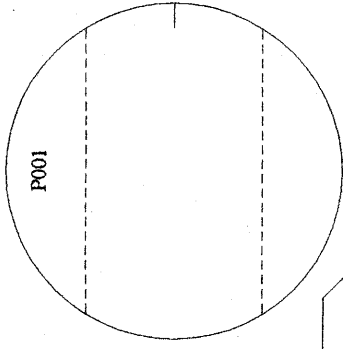
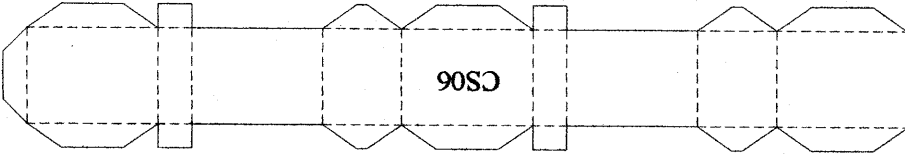
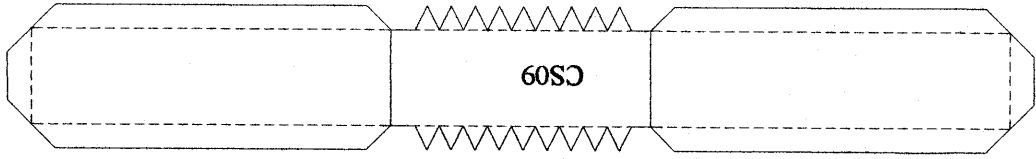
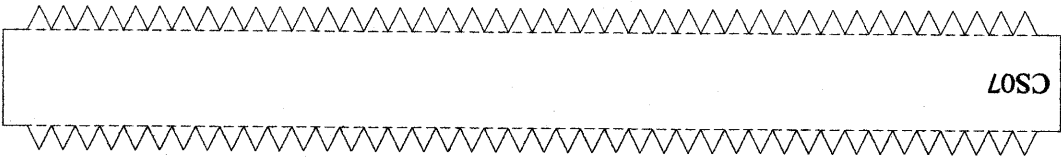

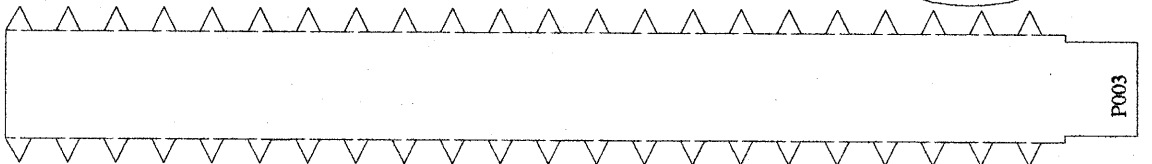
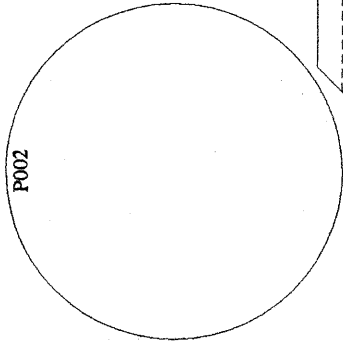
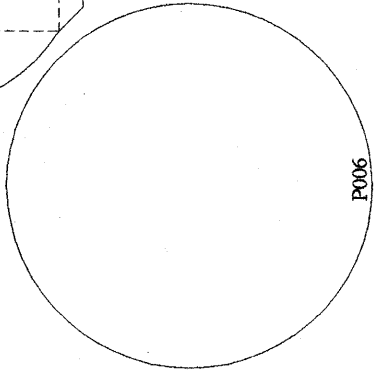
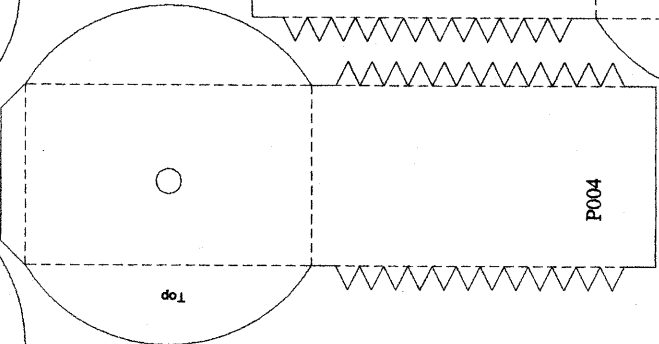
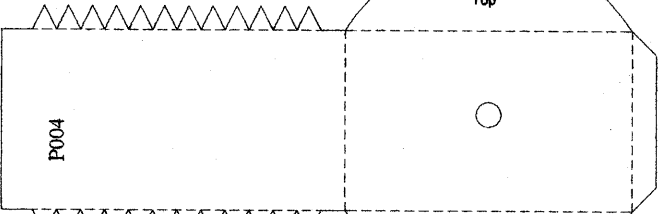
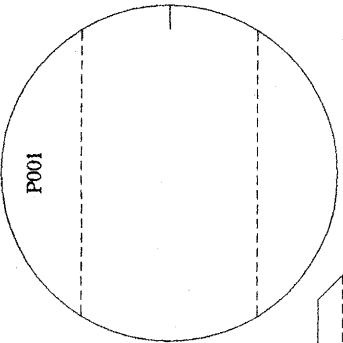
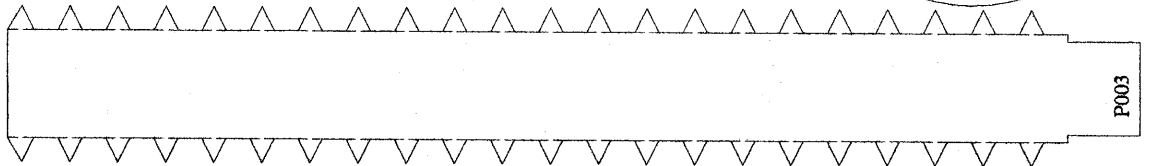
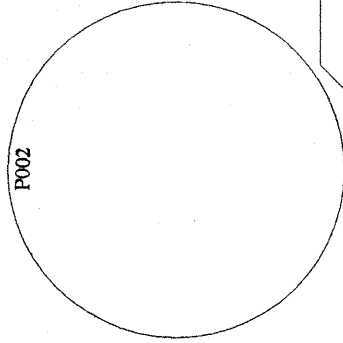
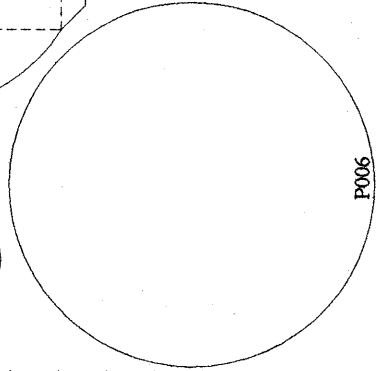
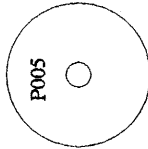
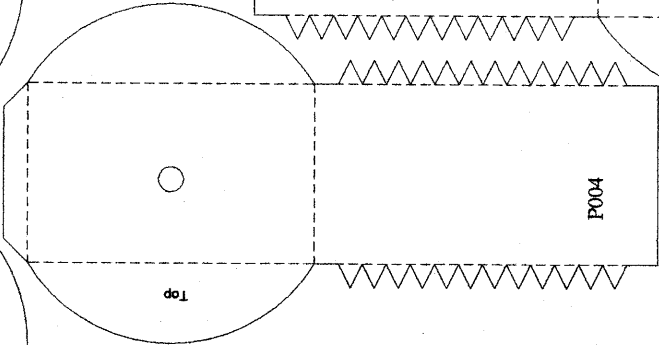
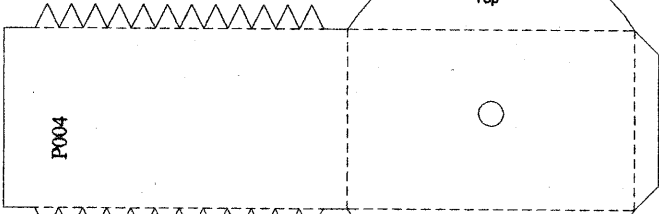
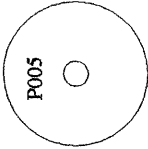
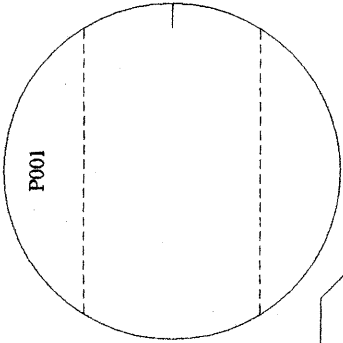
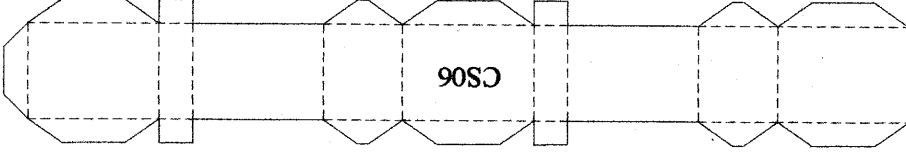
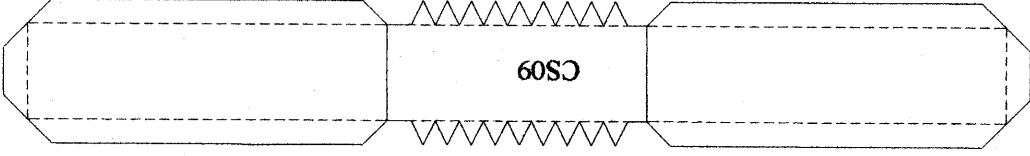
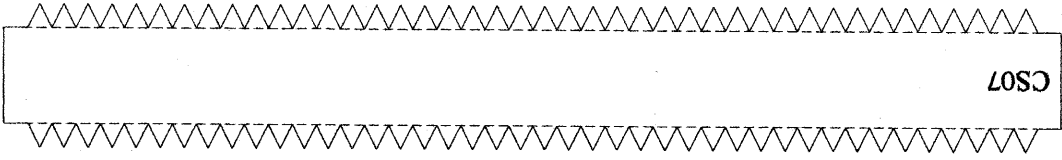

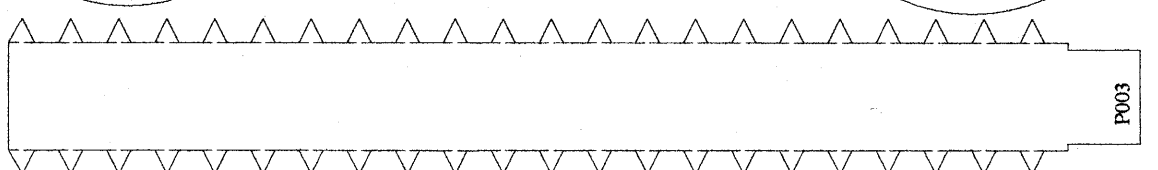
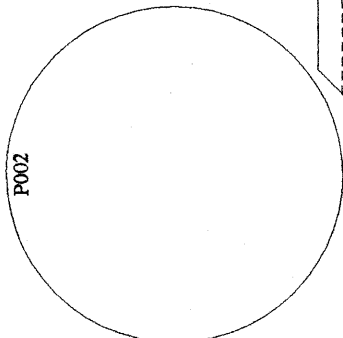
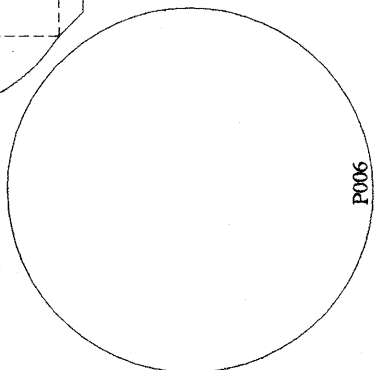
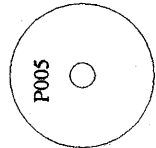
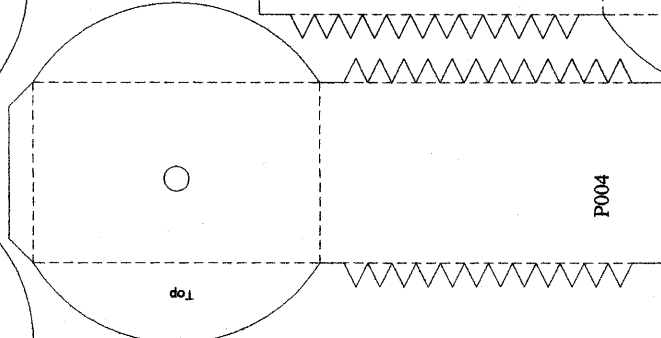
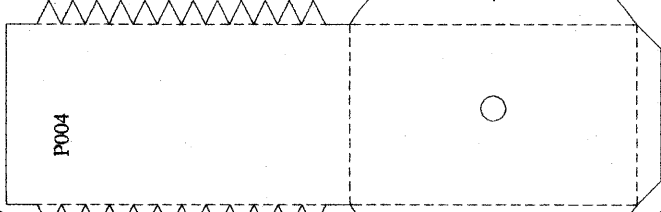
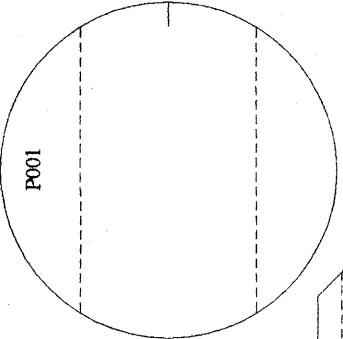
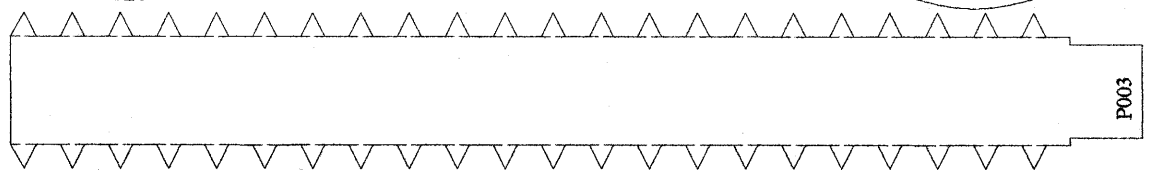
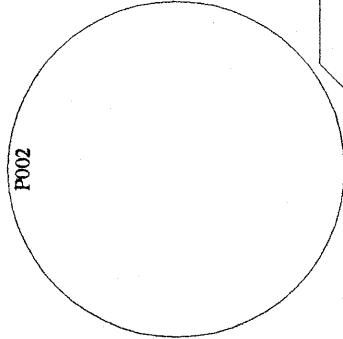
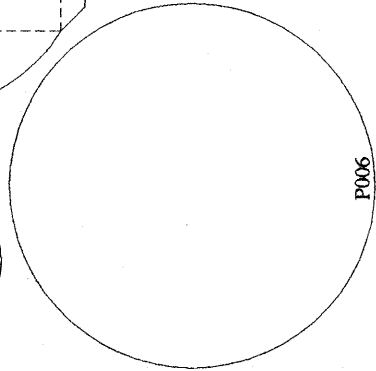
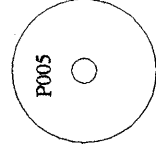
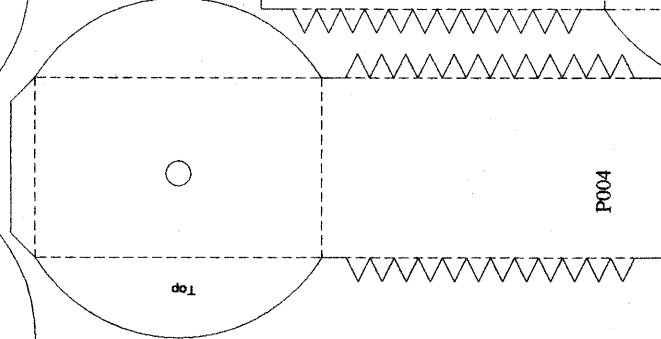
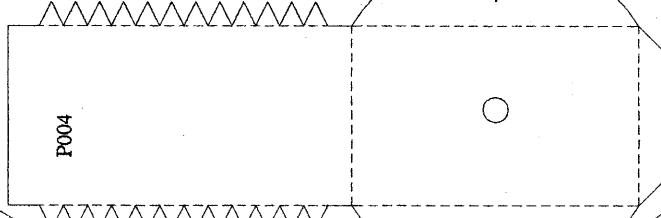
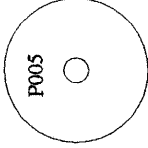
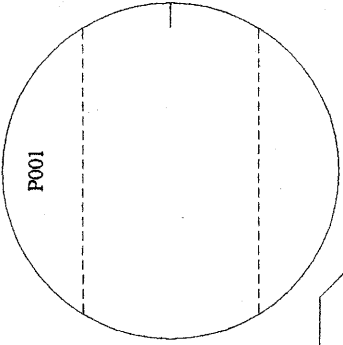
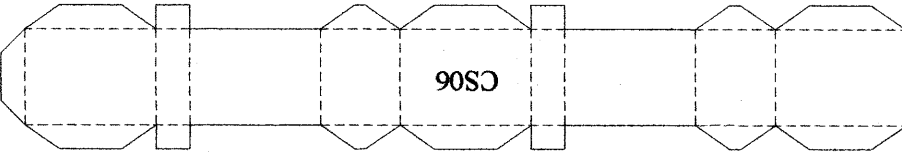
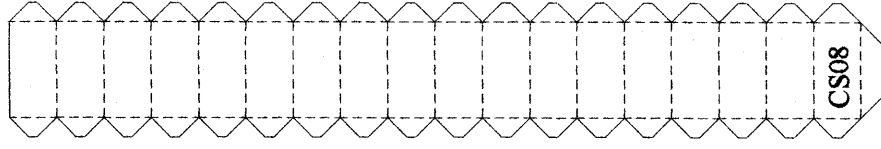
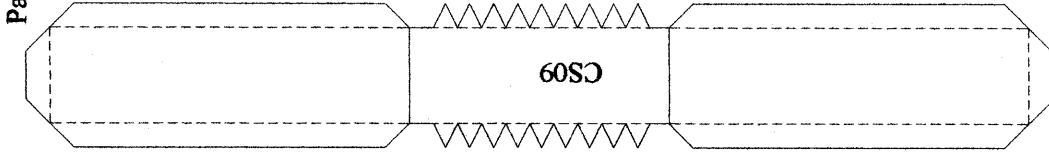

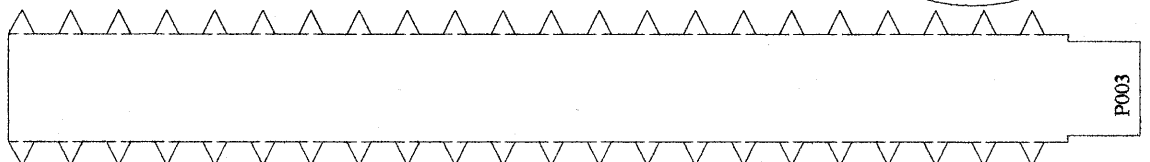
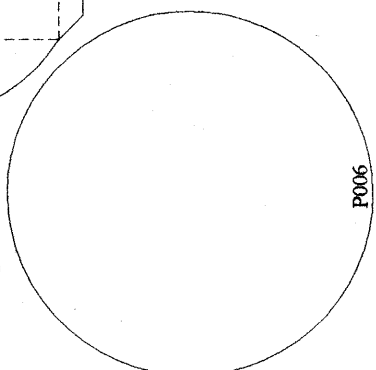
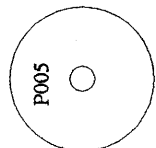
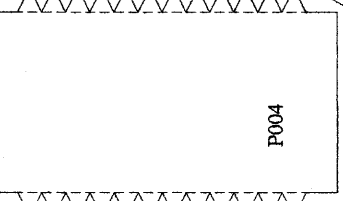
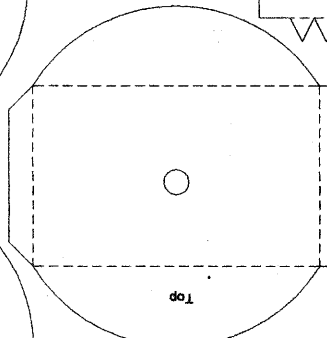
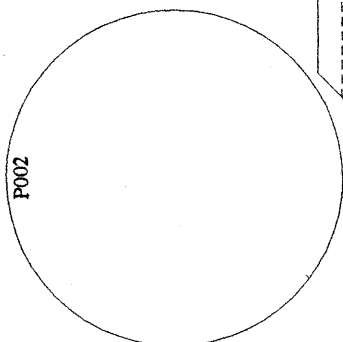
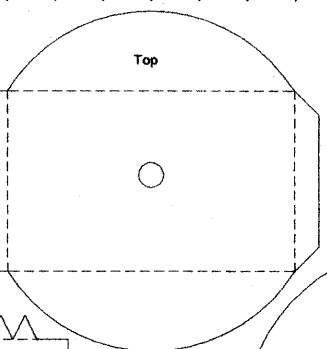
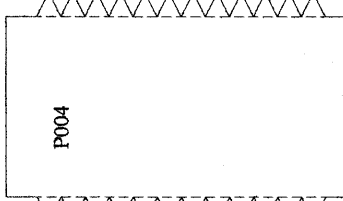
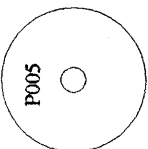
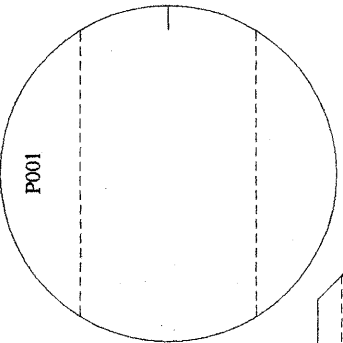
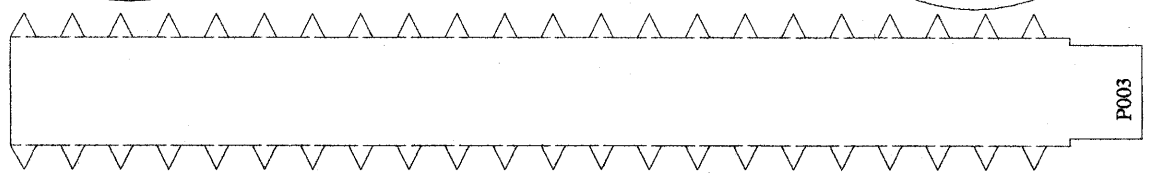
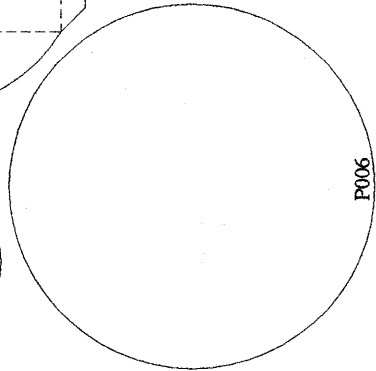
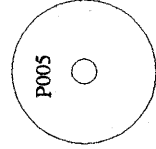
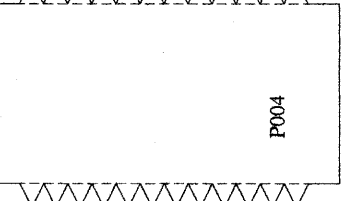
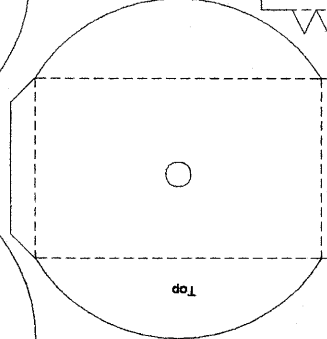
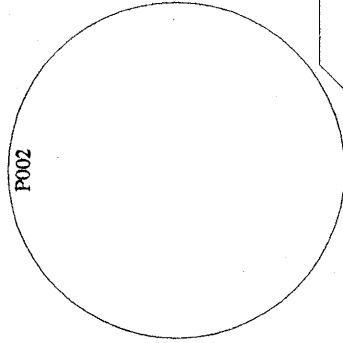
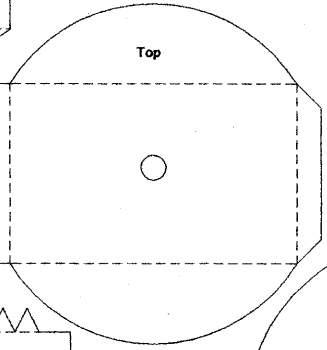
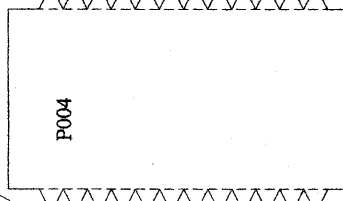
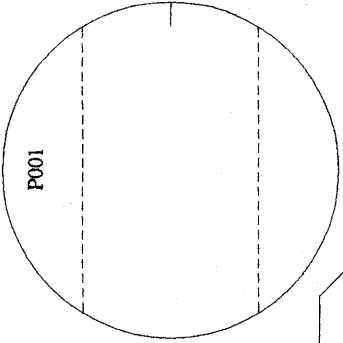
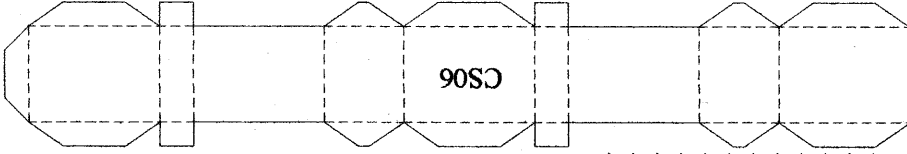
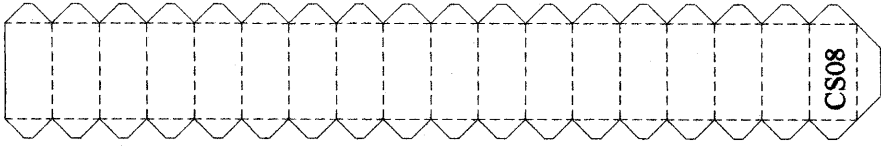
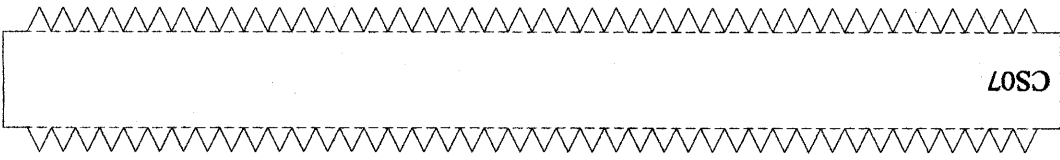

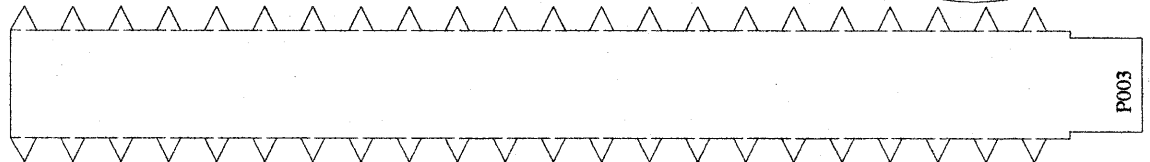
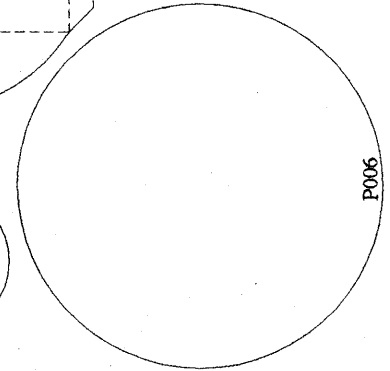
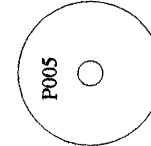
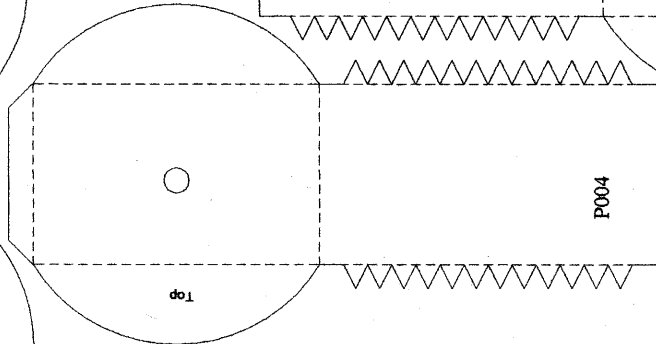
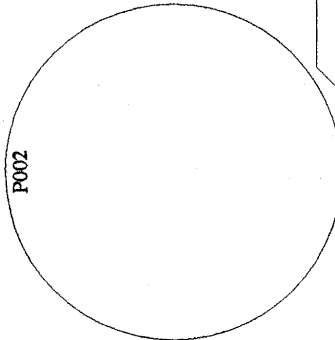
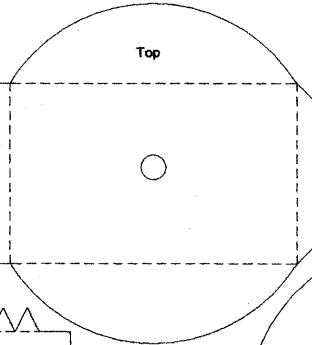
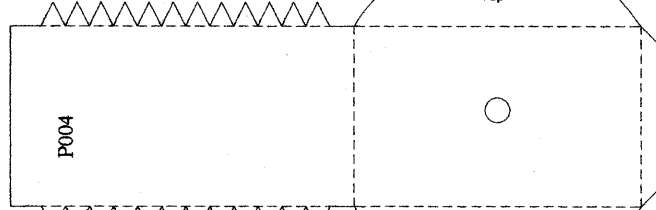
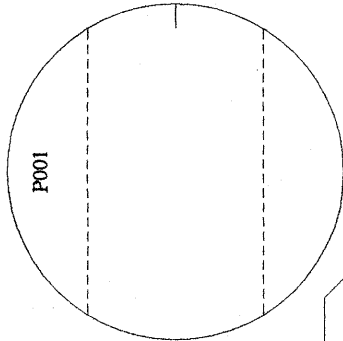
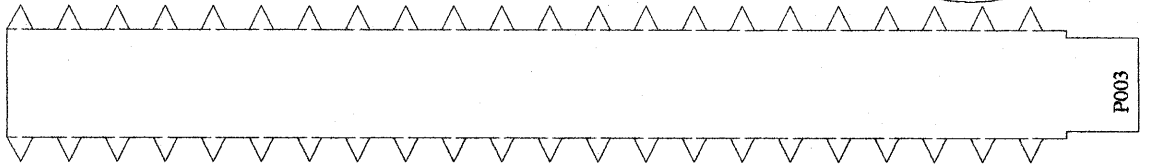
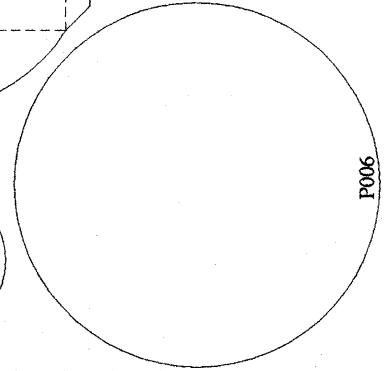
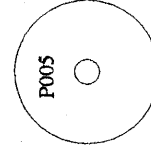
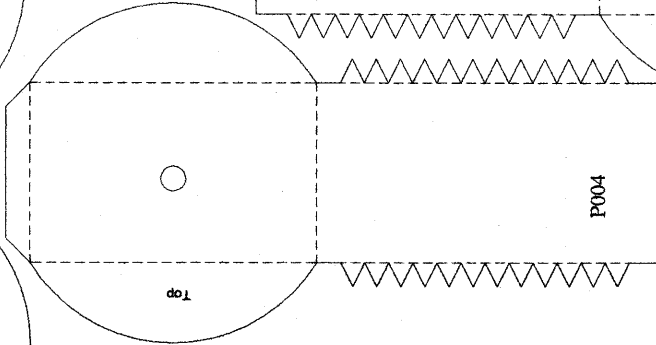
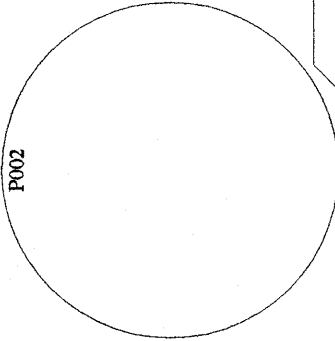
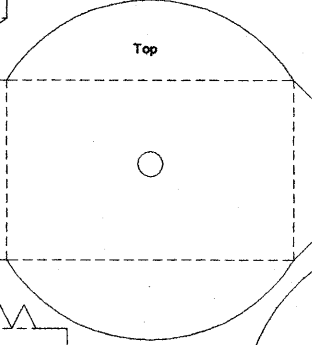
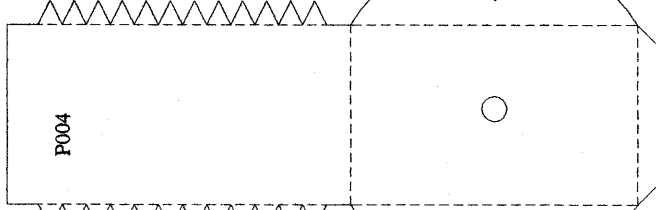
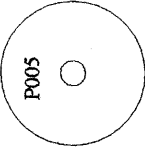
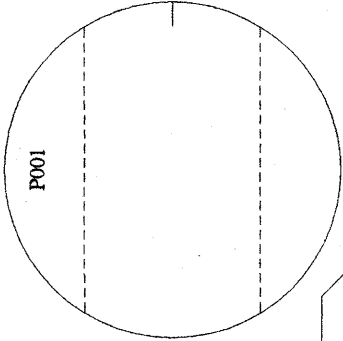
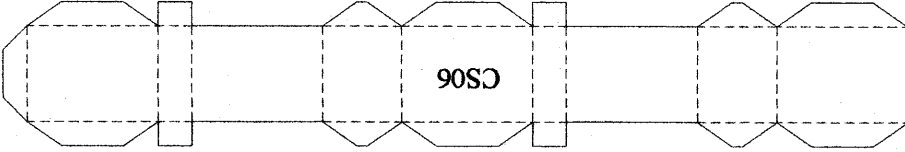
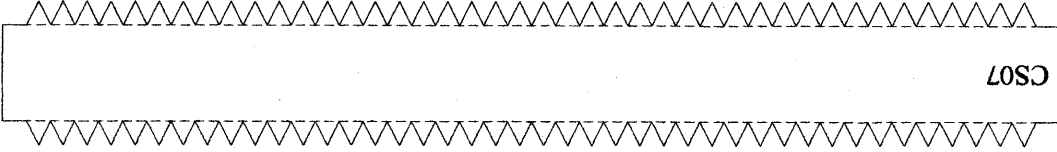
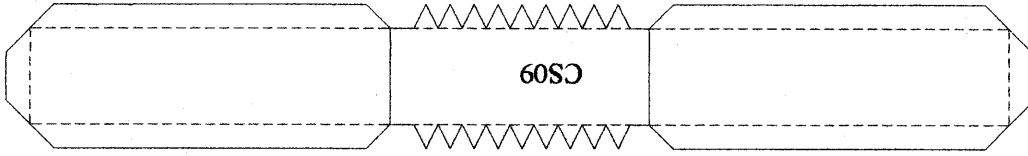

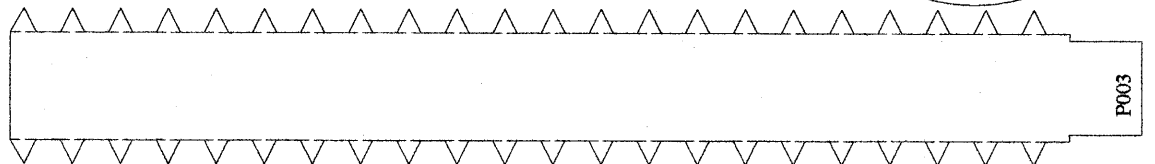
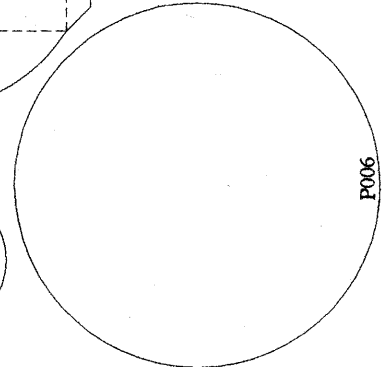
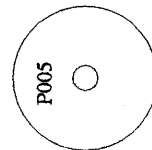
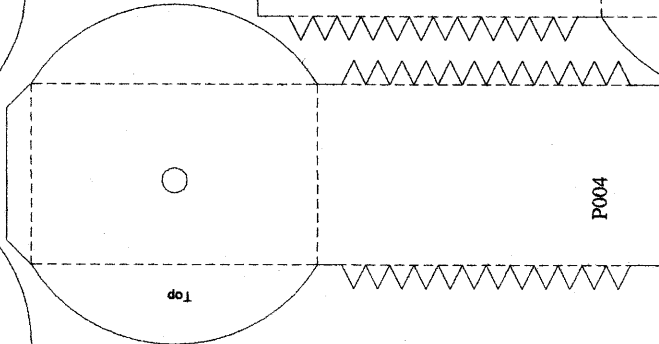
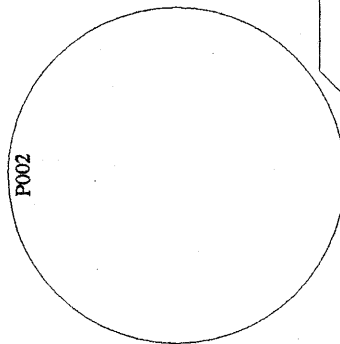
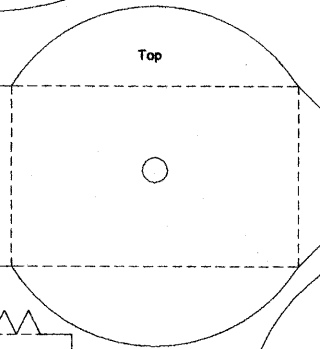
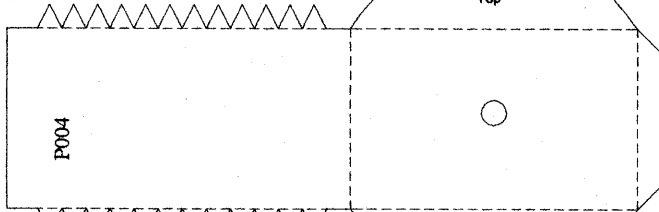
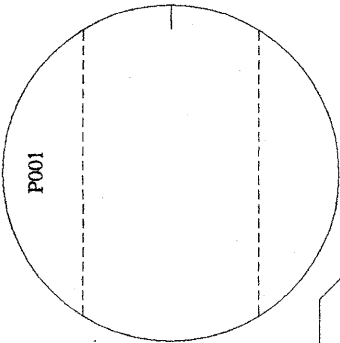
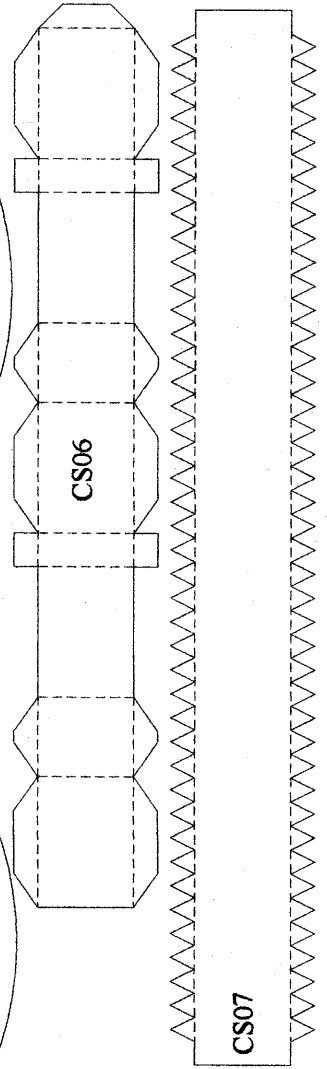
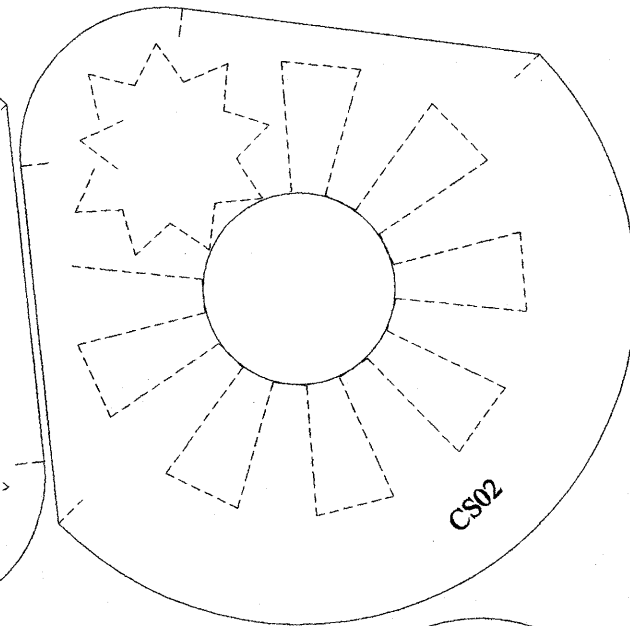
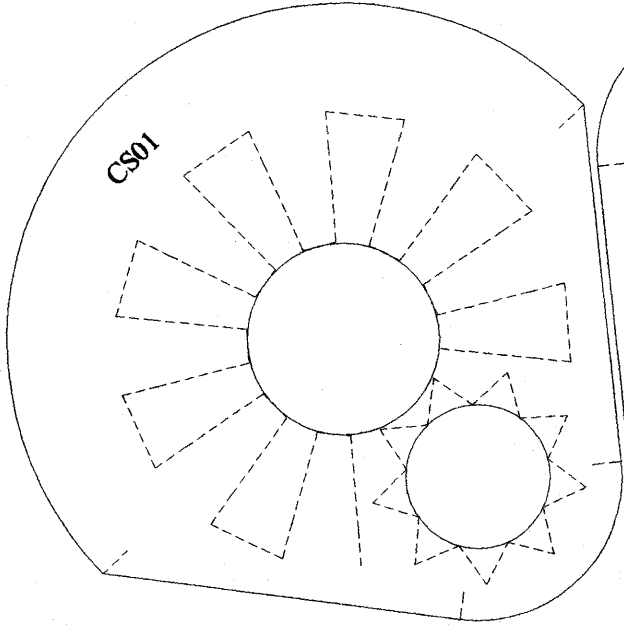
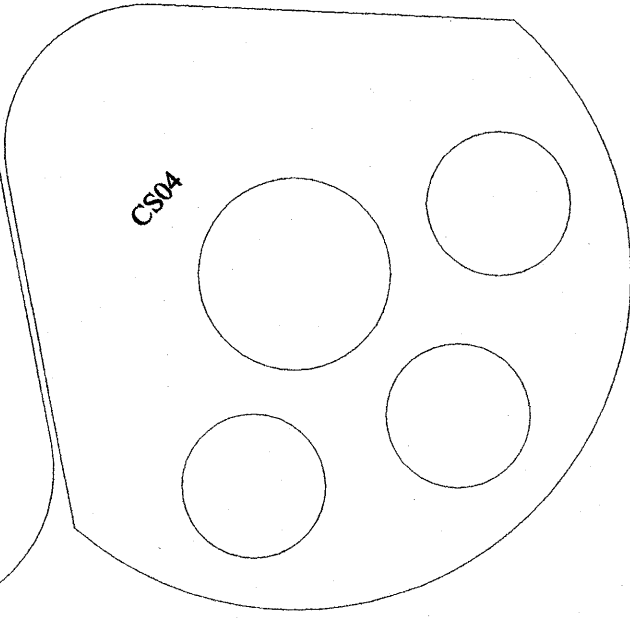
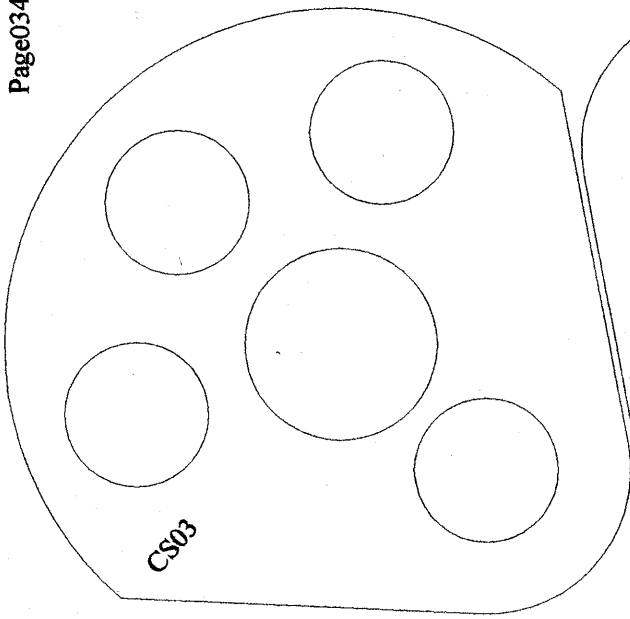

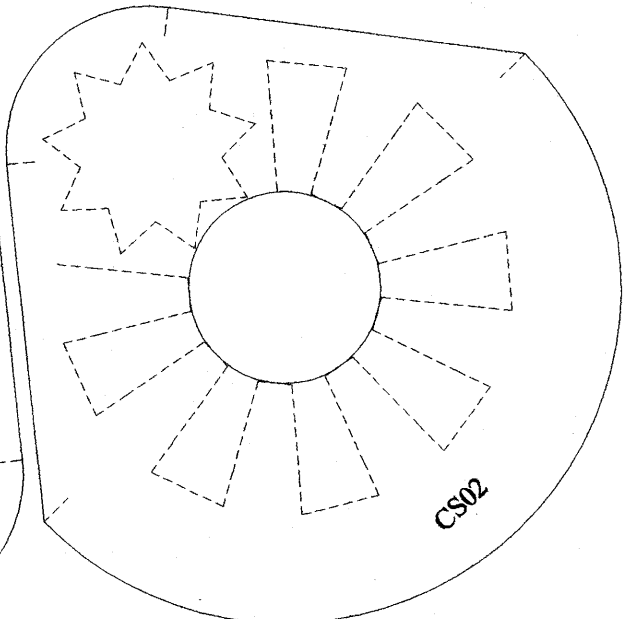
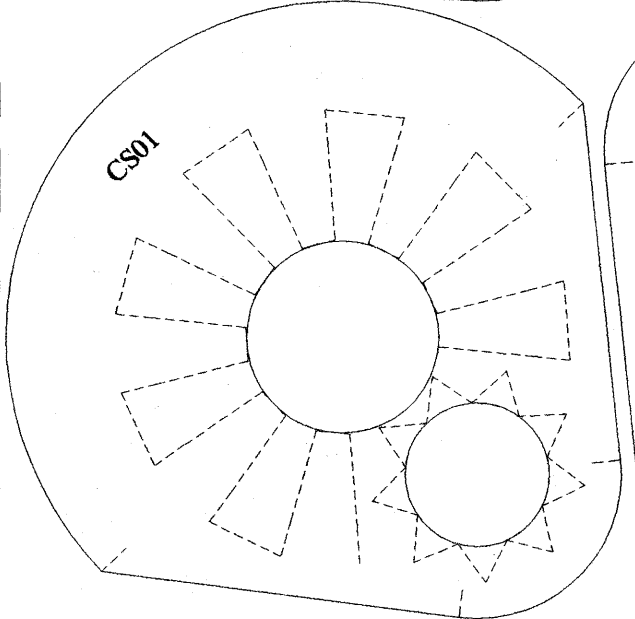
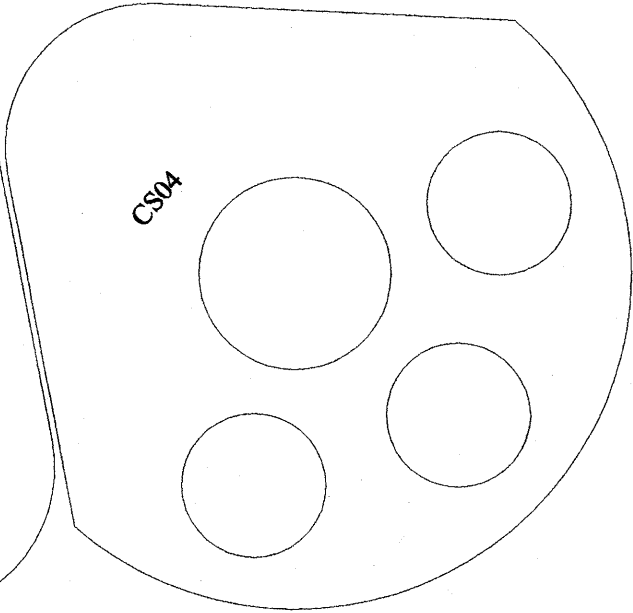
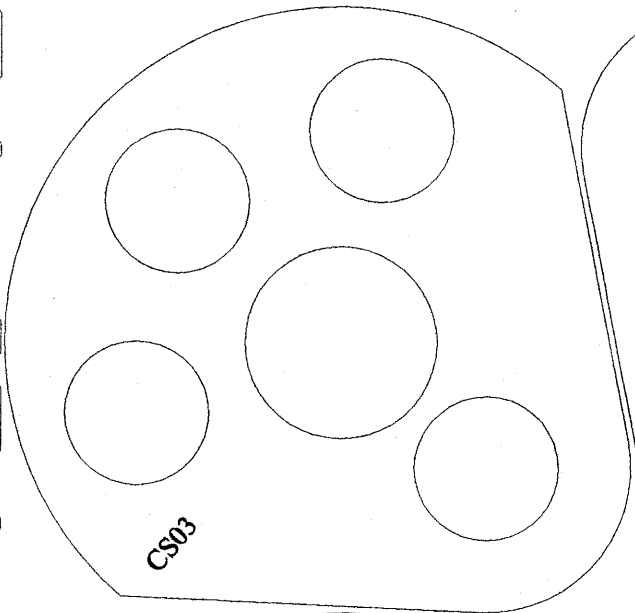
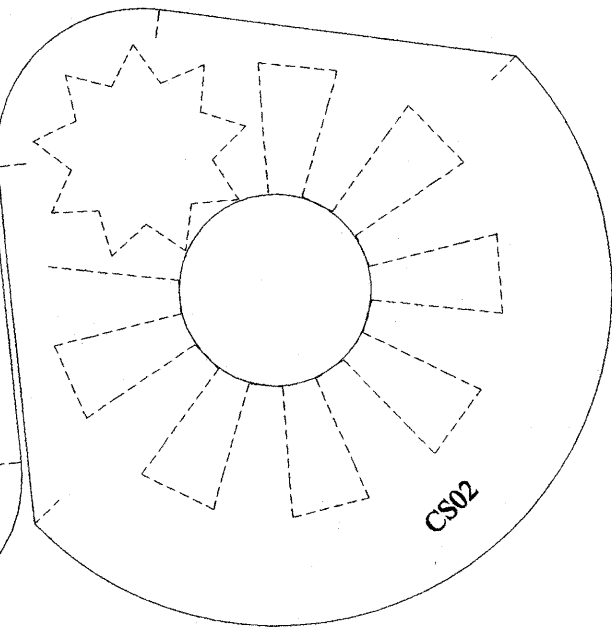
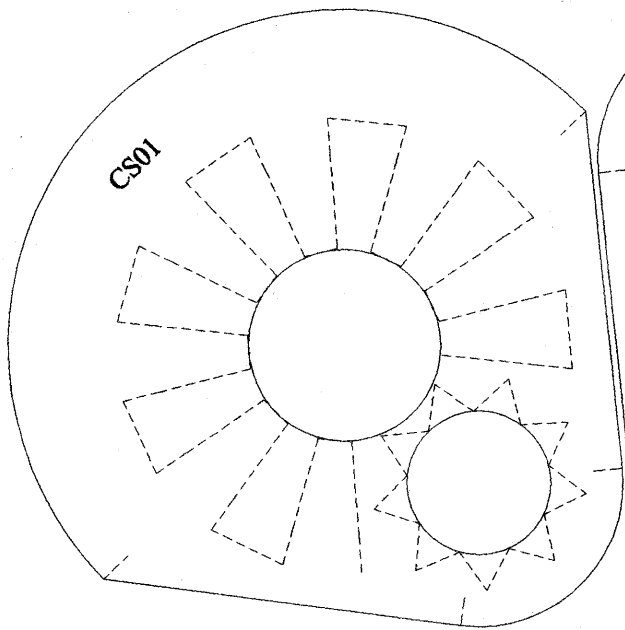
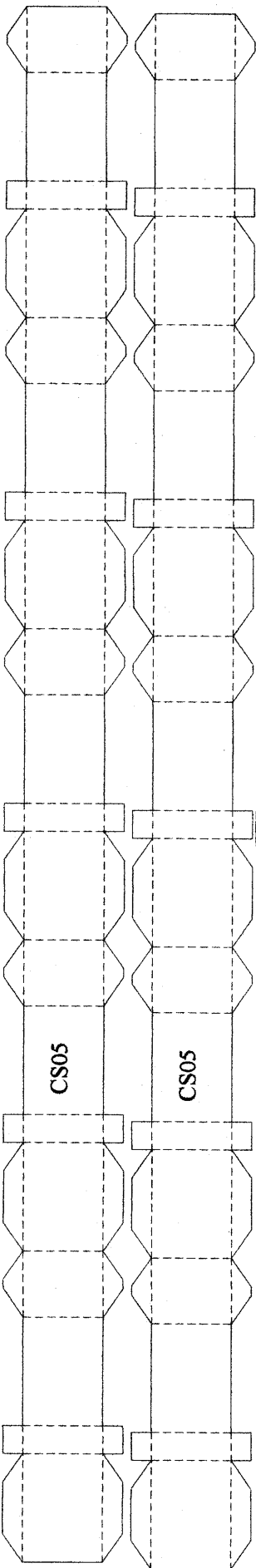
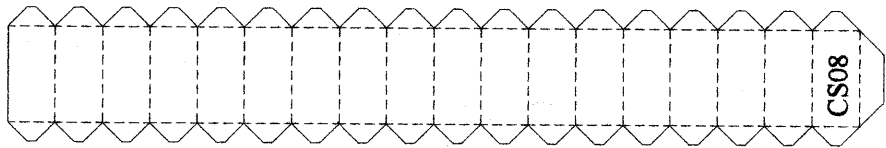



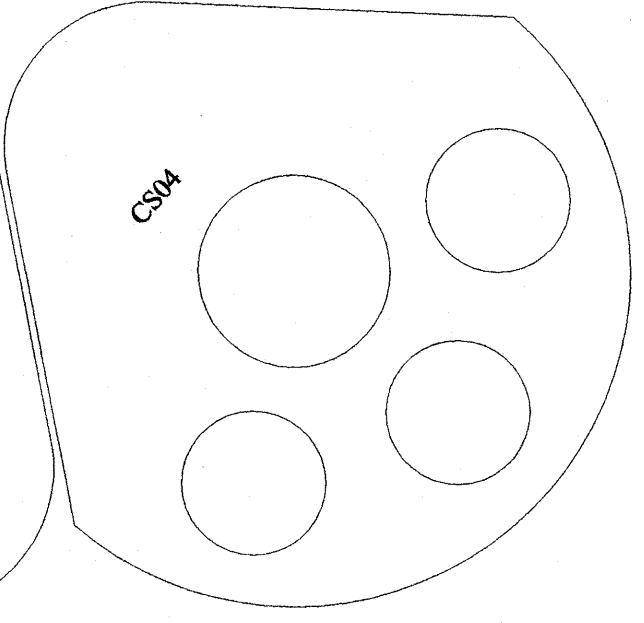
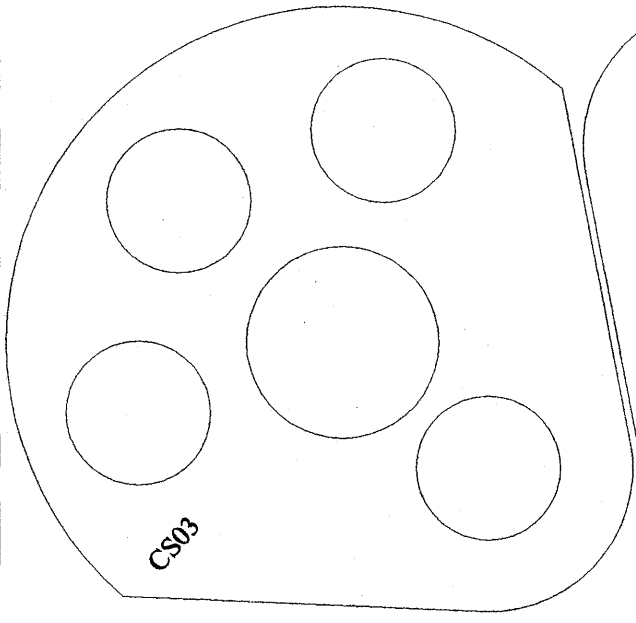
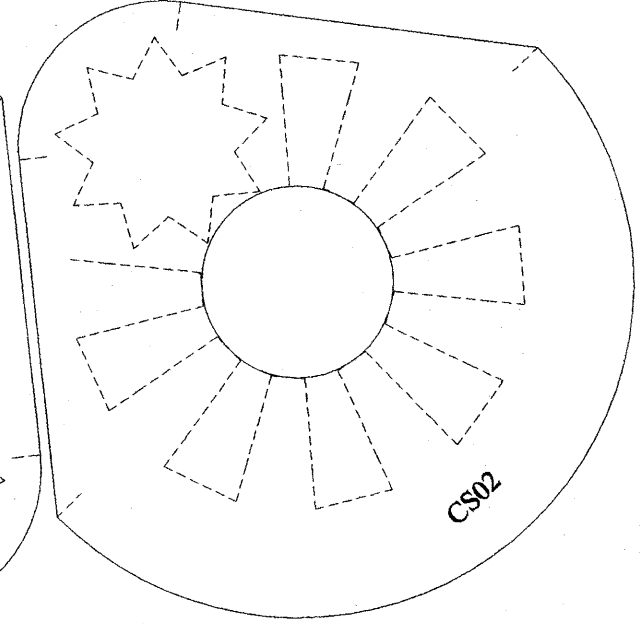
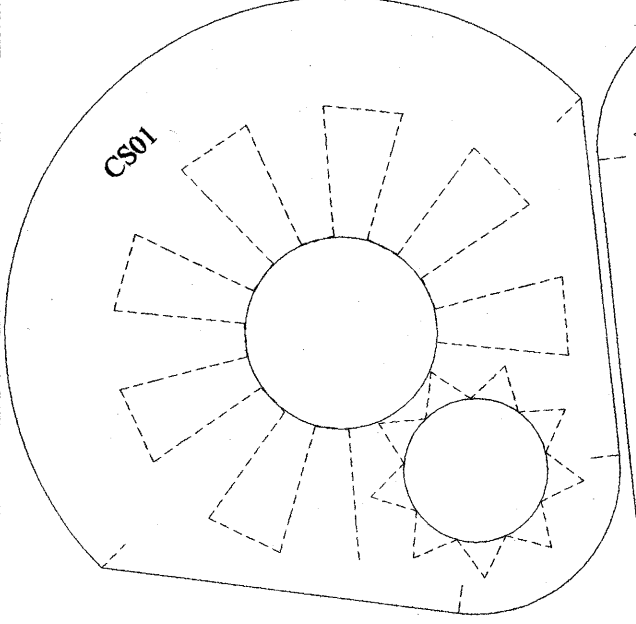
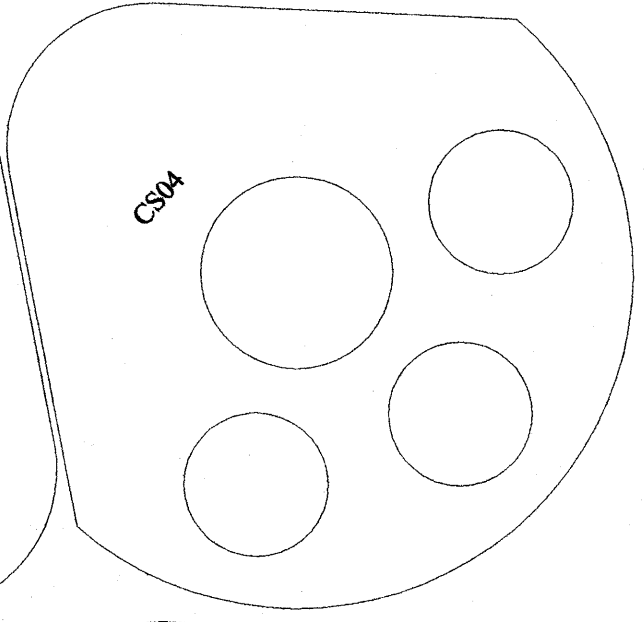
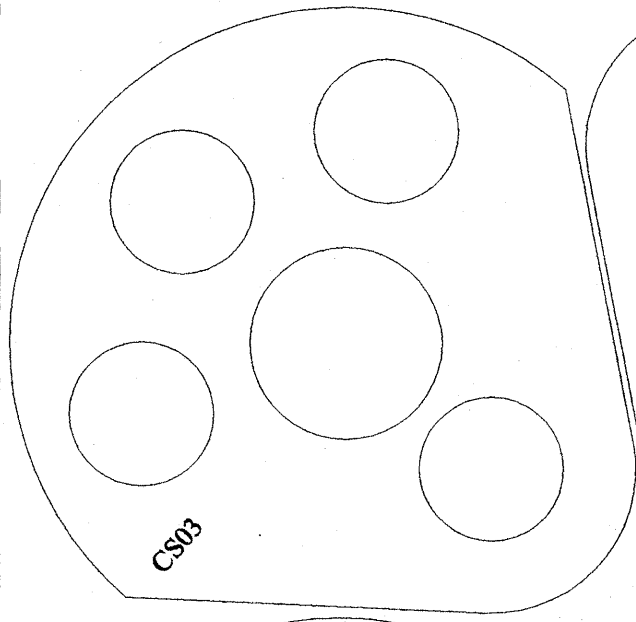
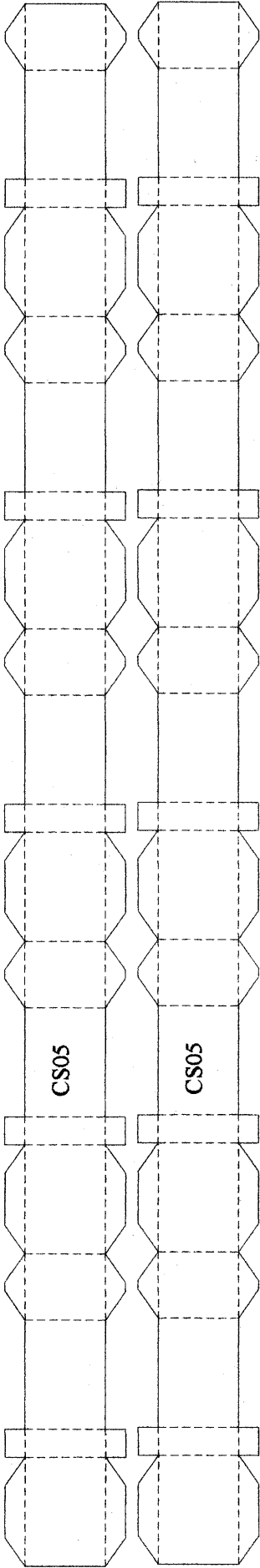
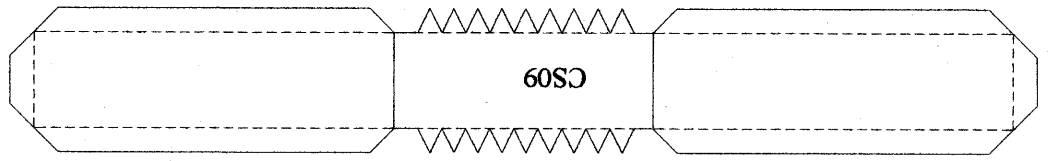

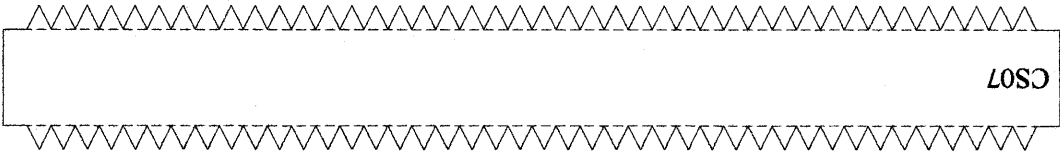

CS07

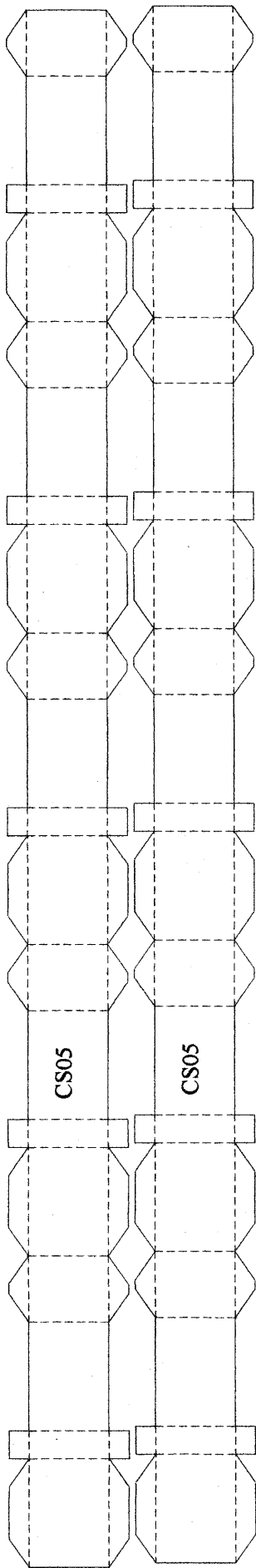

CS05

CS05

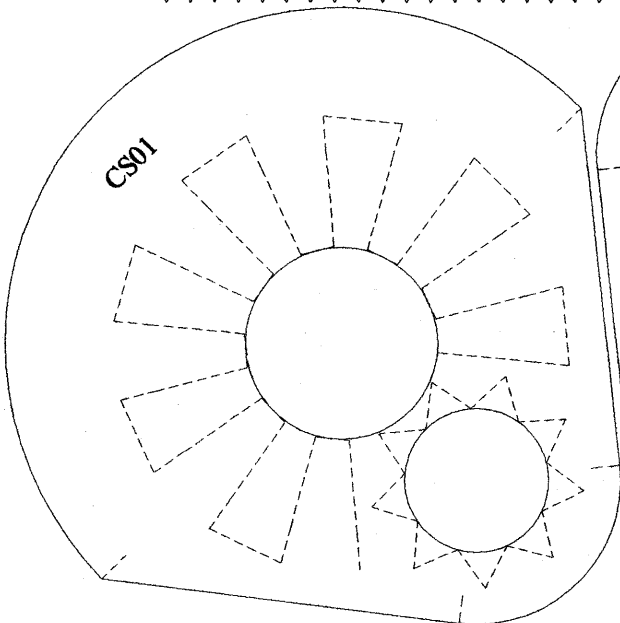

CS01

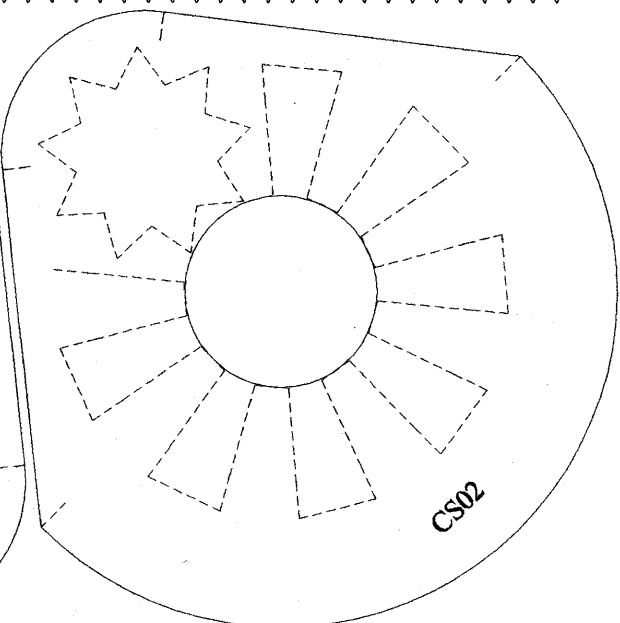

CS02

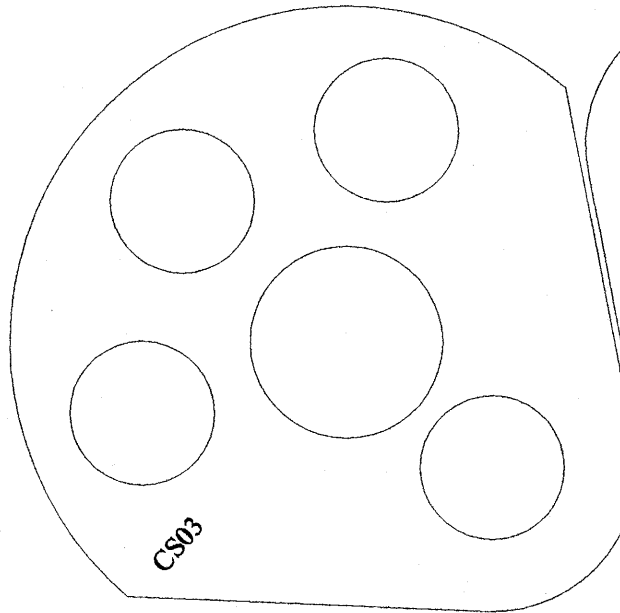

CS03

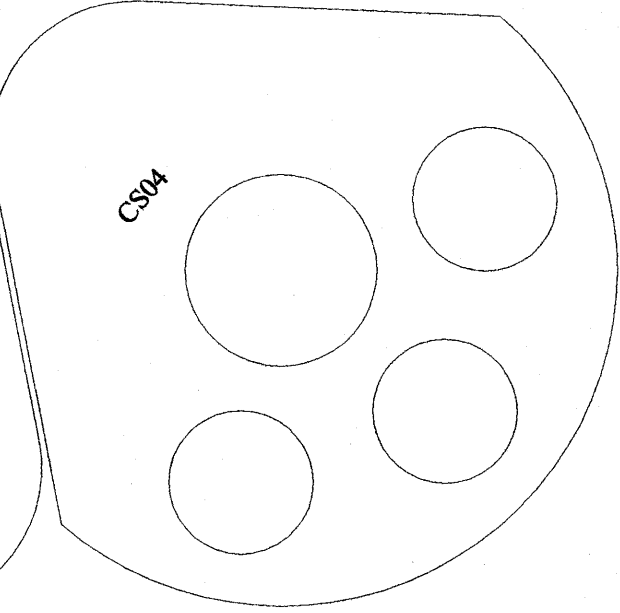

CS04

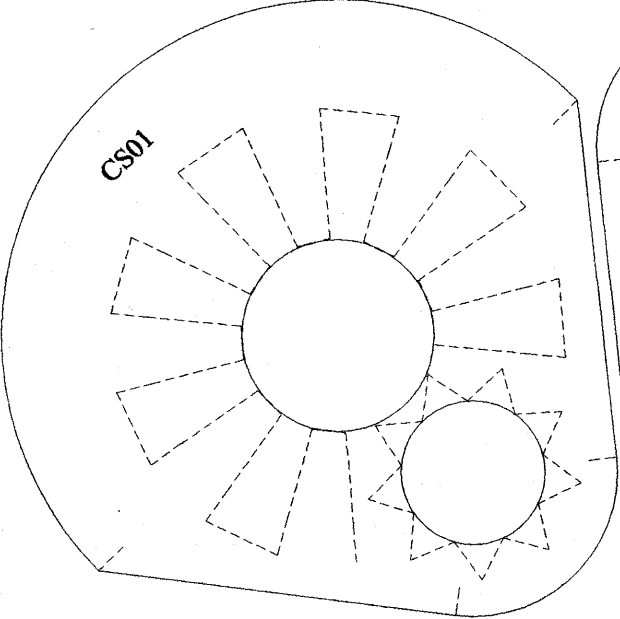

CS01

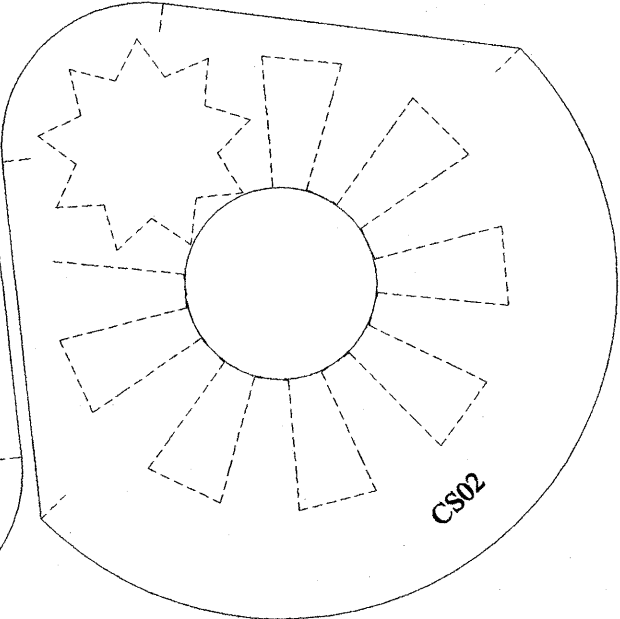

CS02

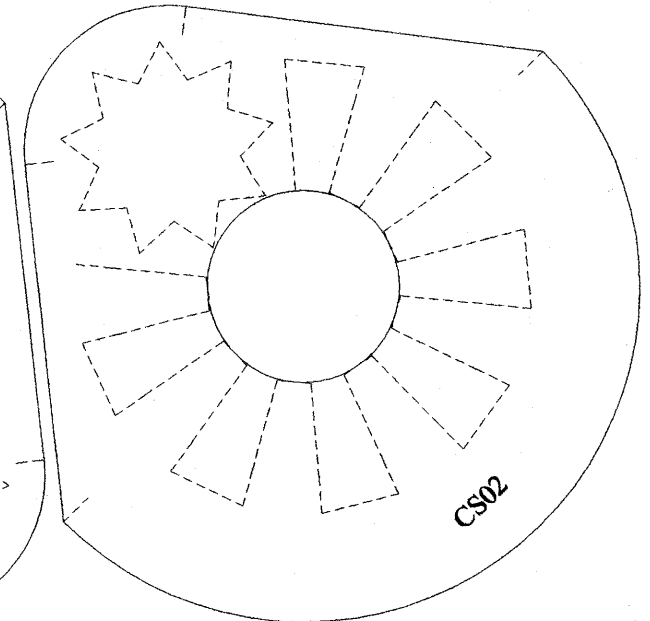
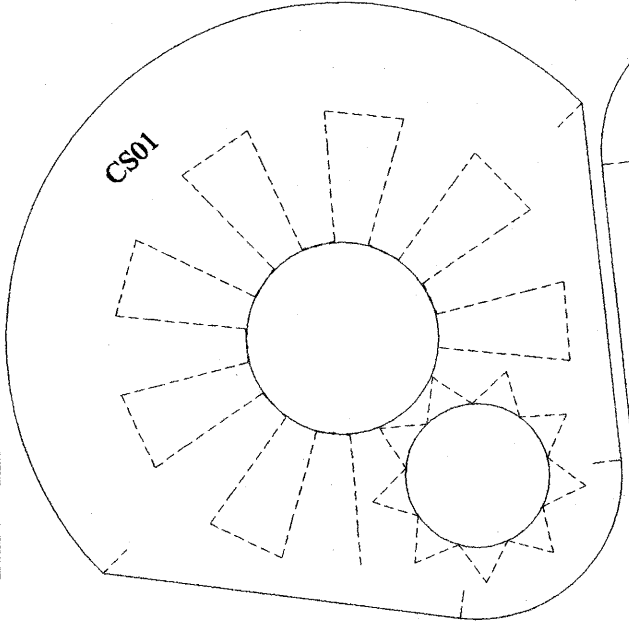
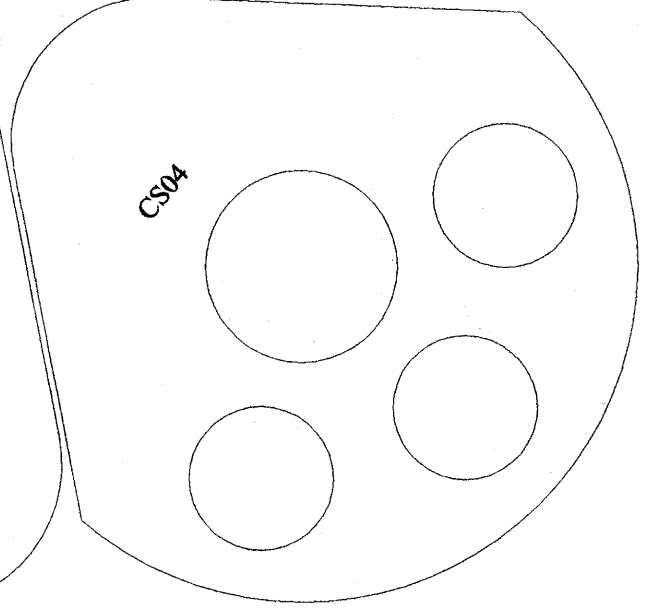
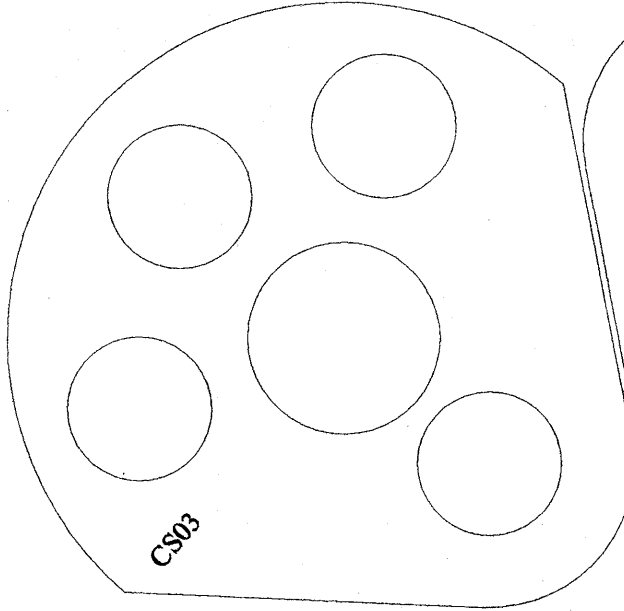
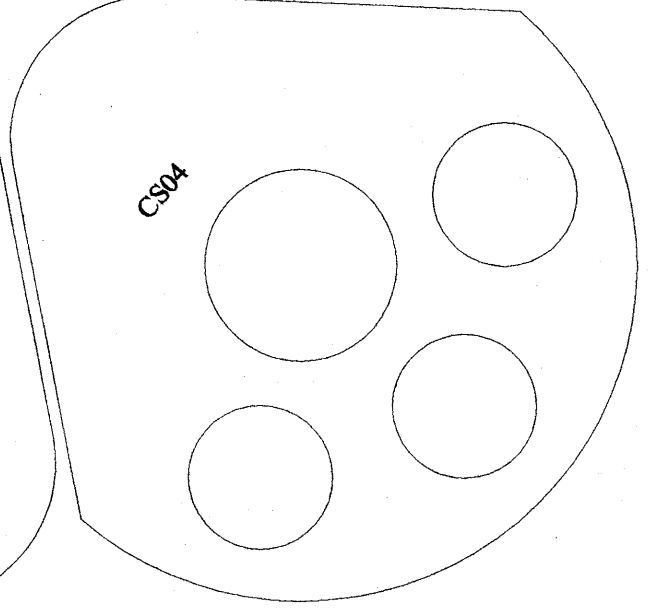
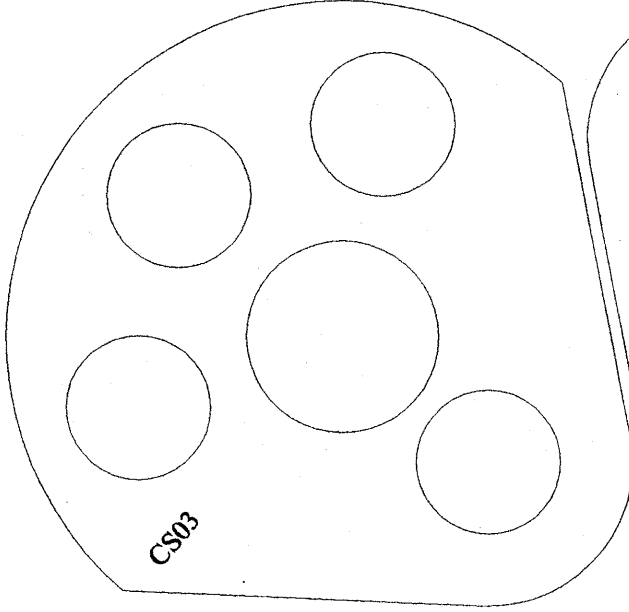
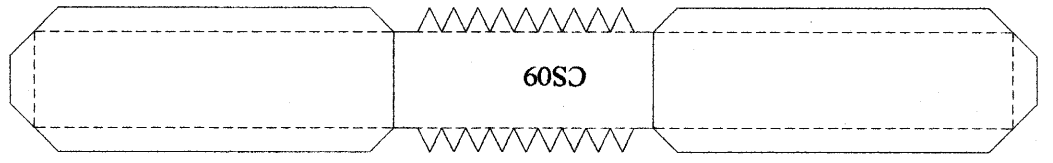
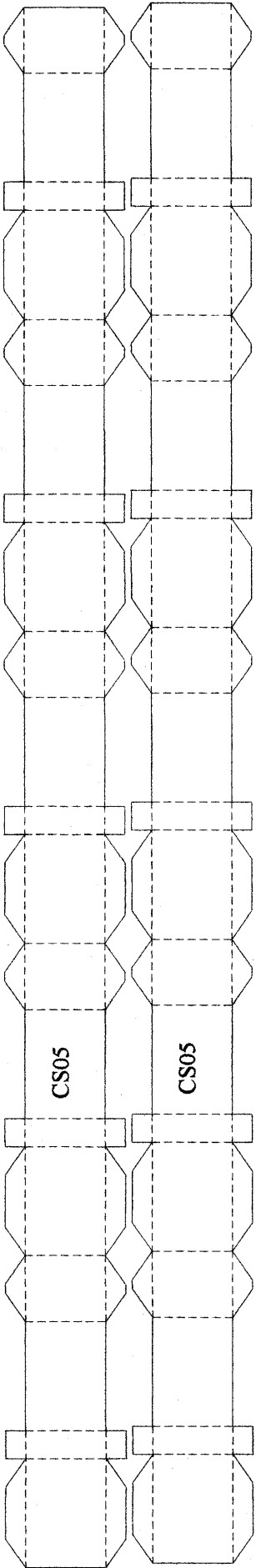

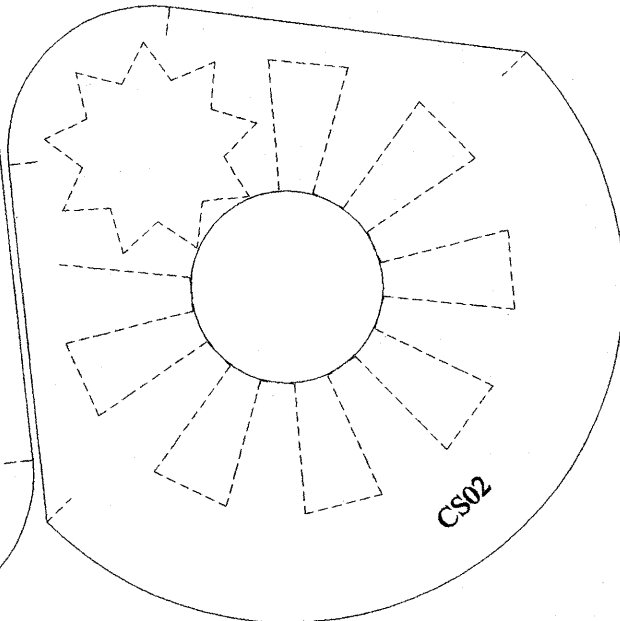
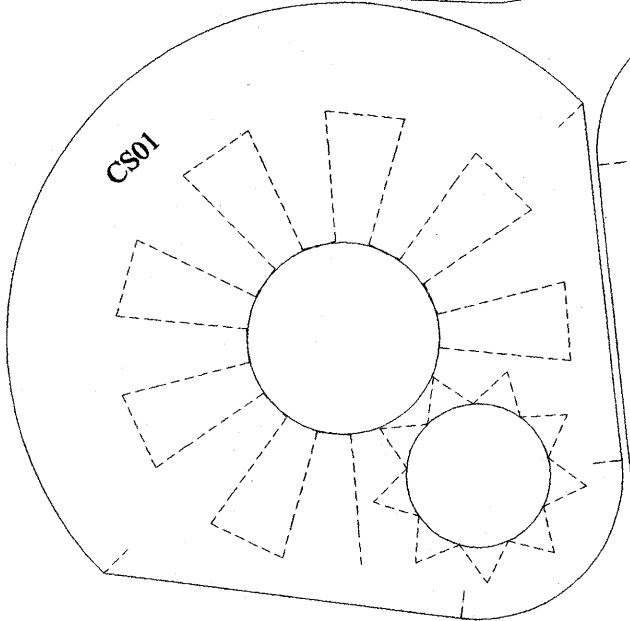
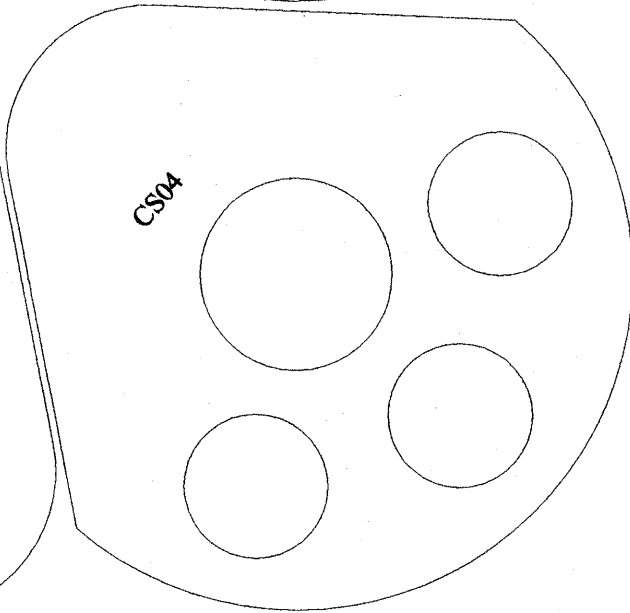
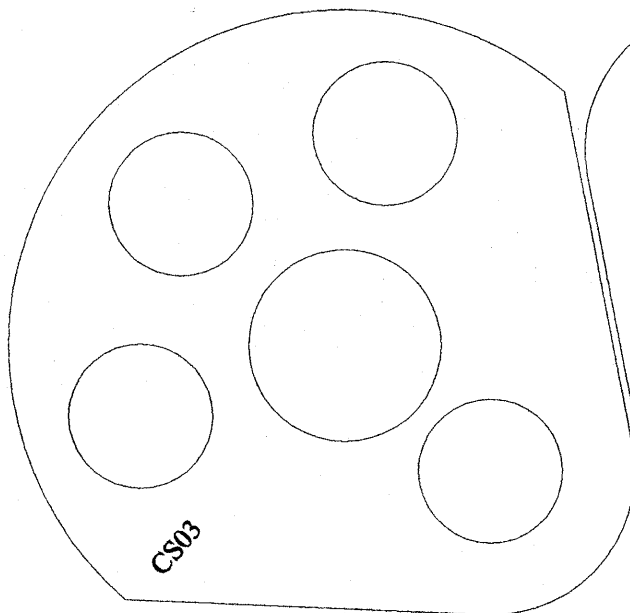
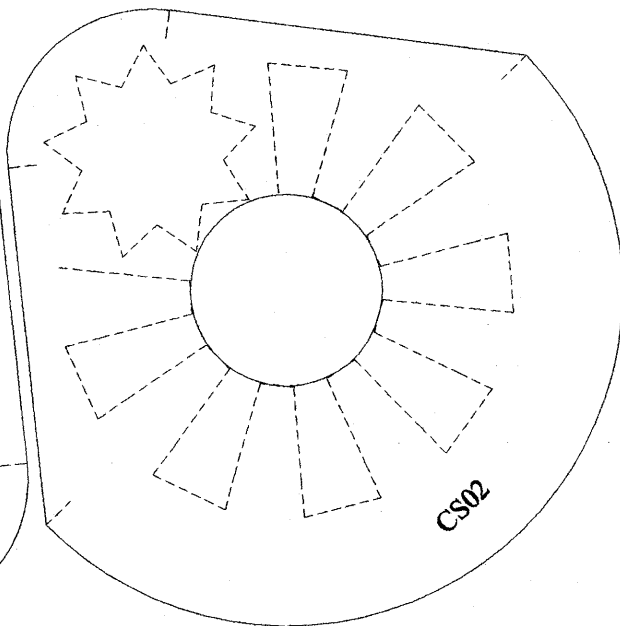
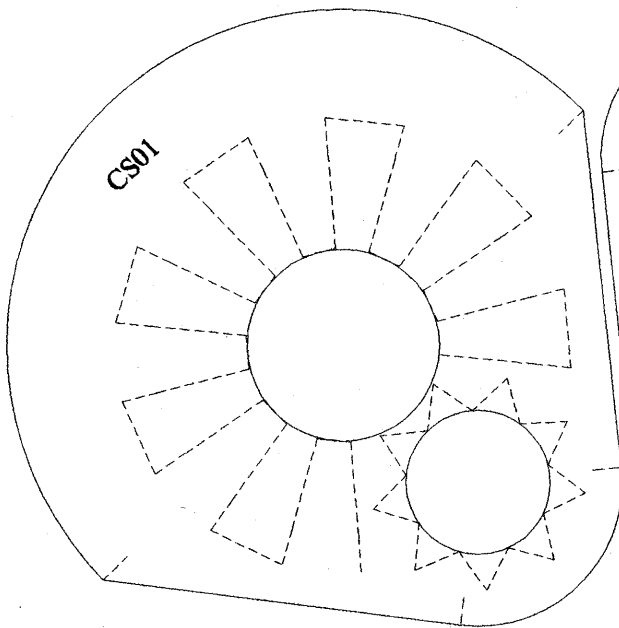
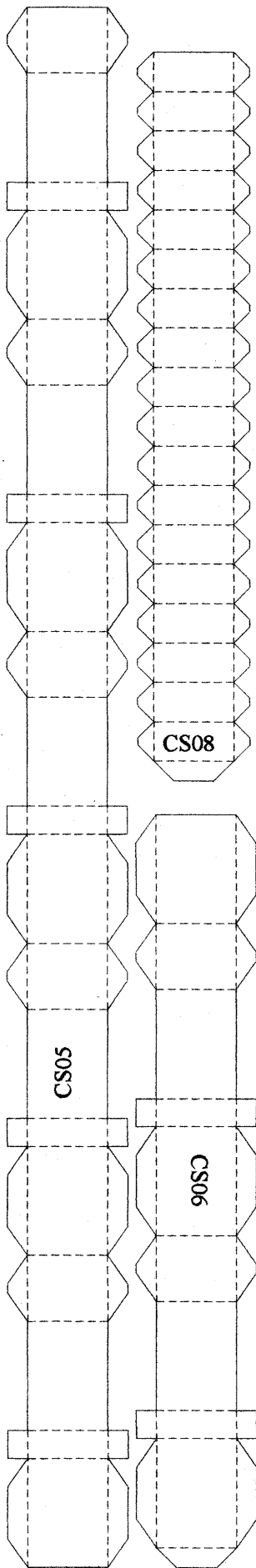
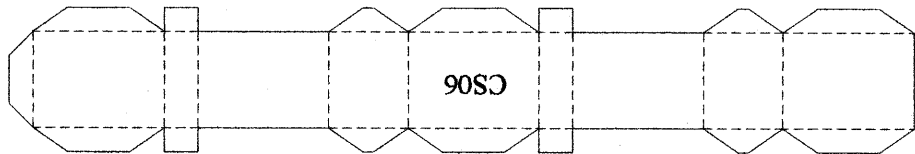

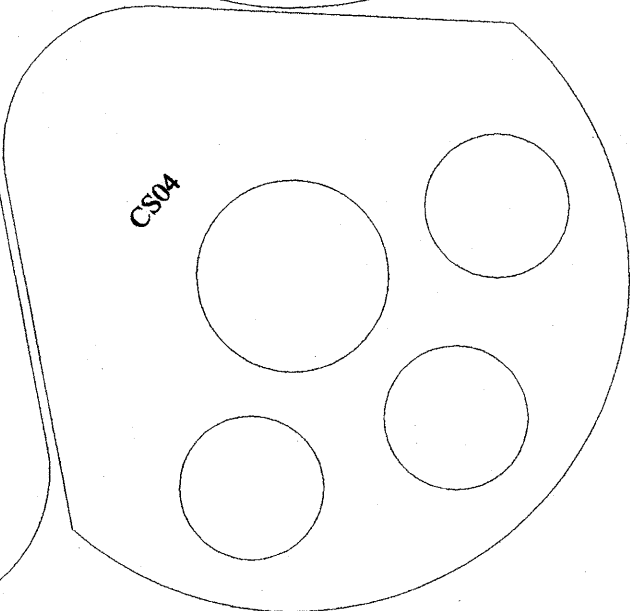
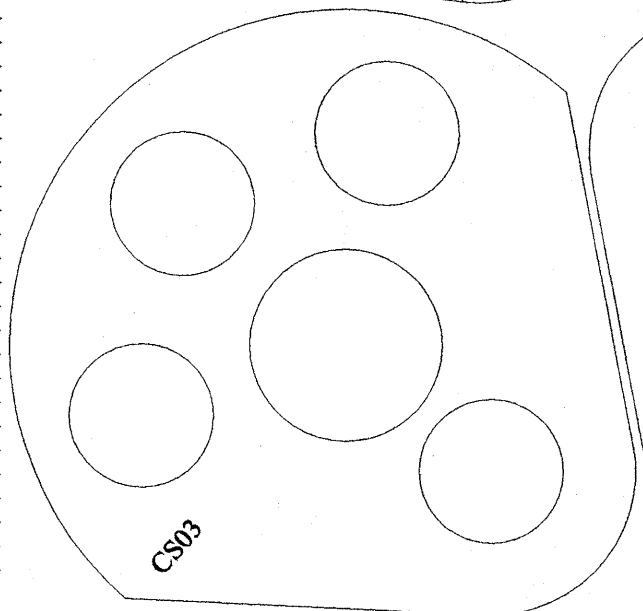
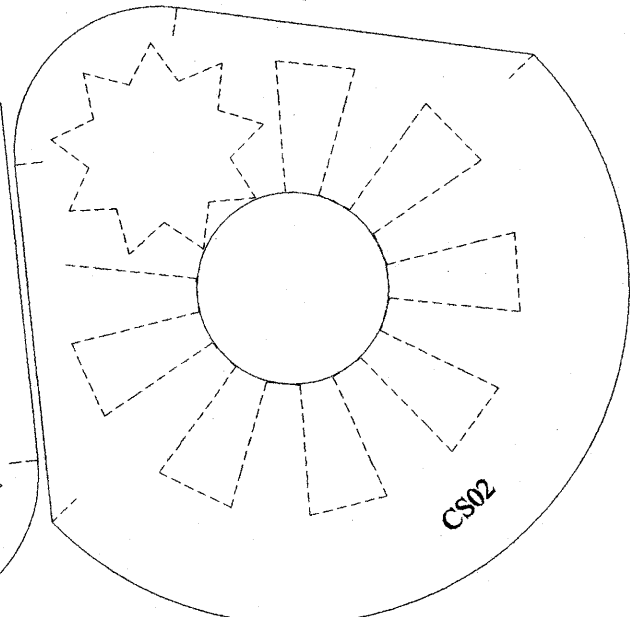
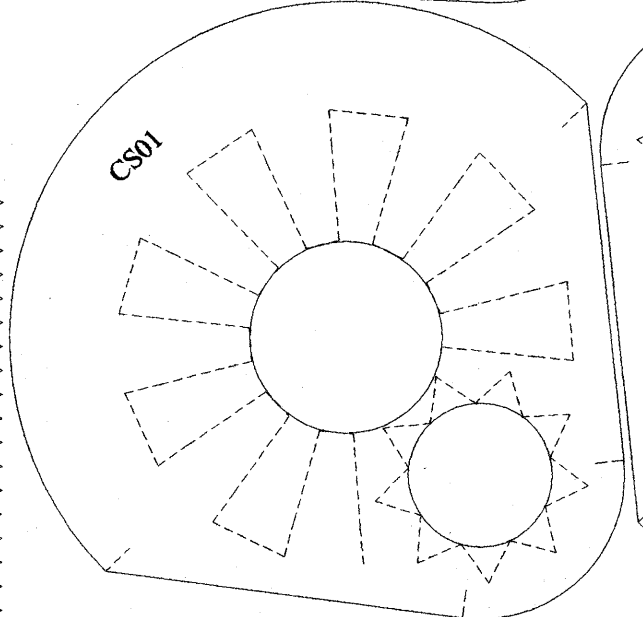
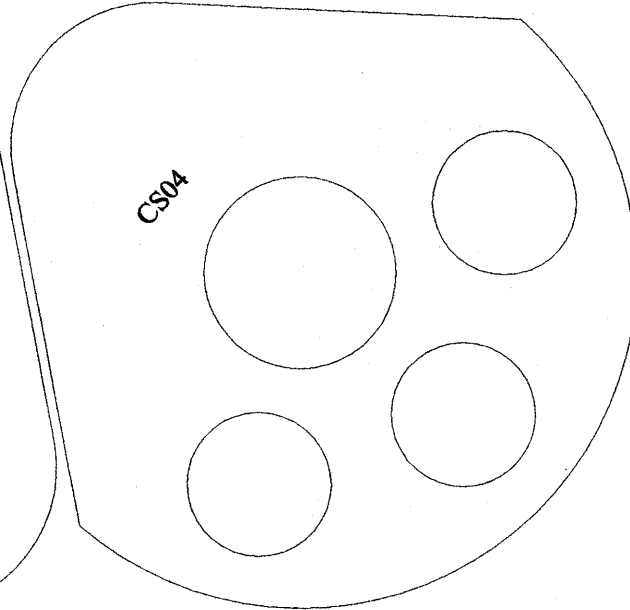
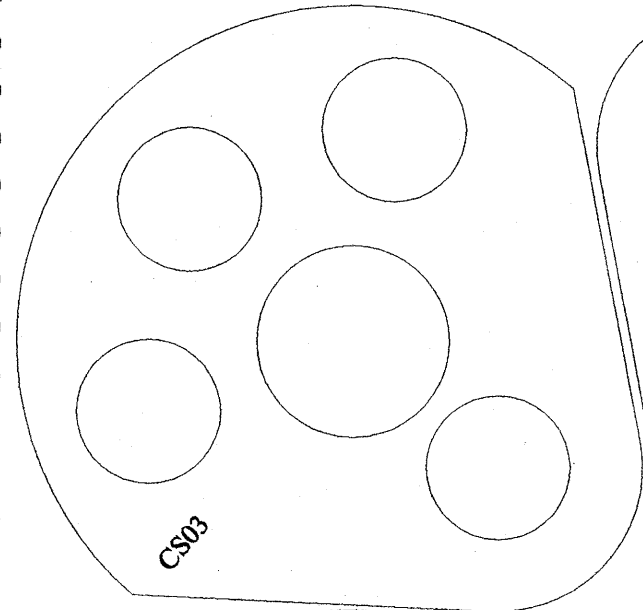
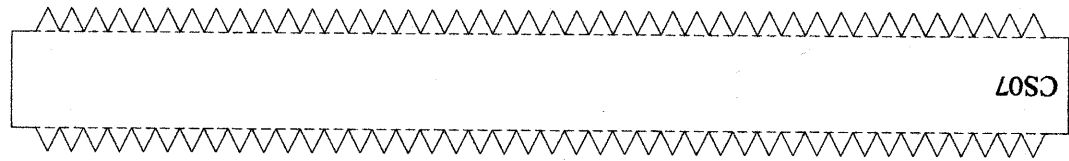
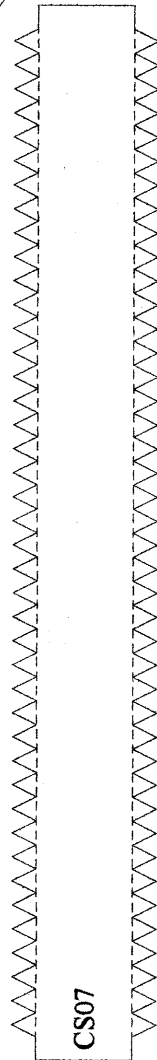
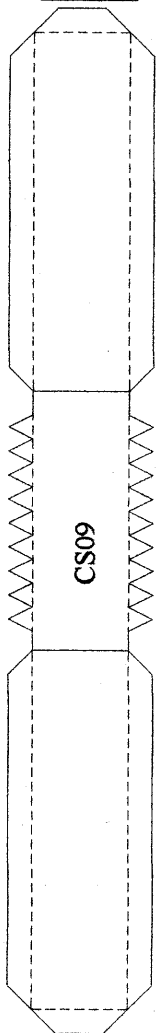
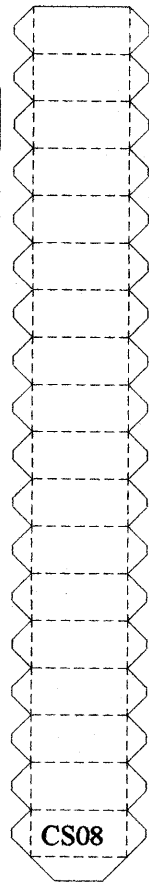
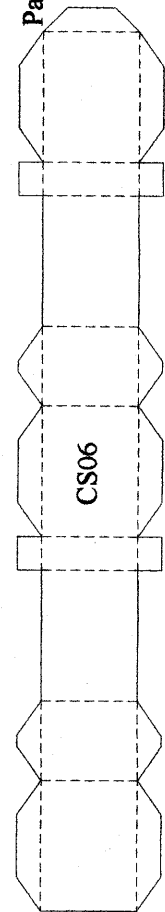

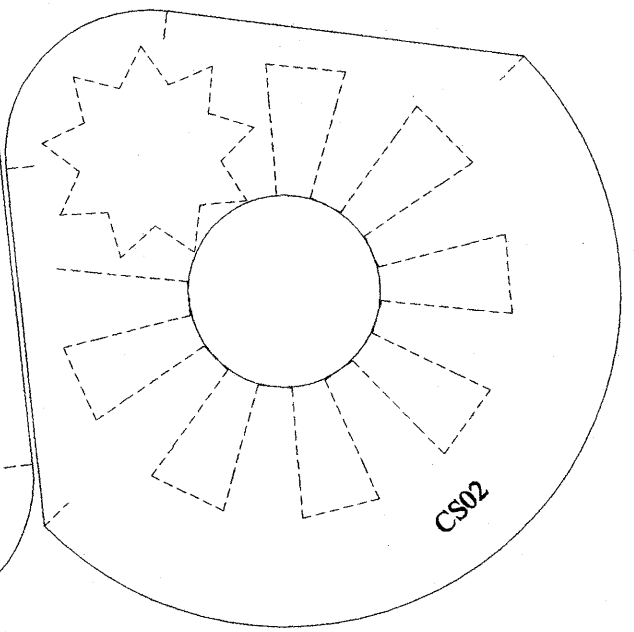
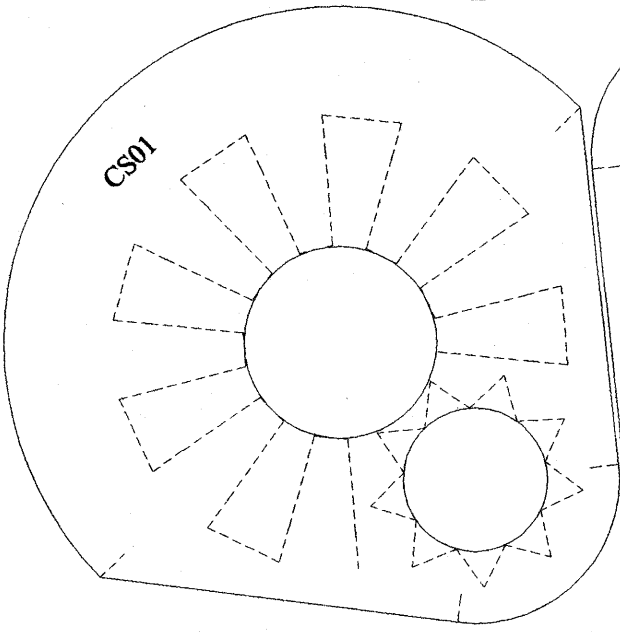
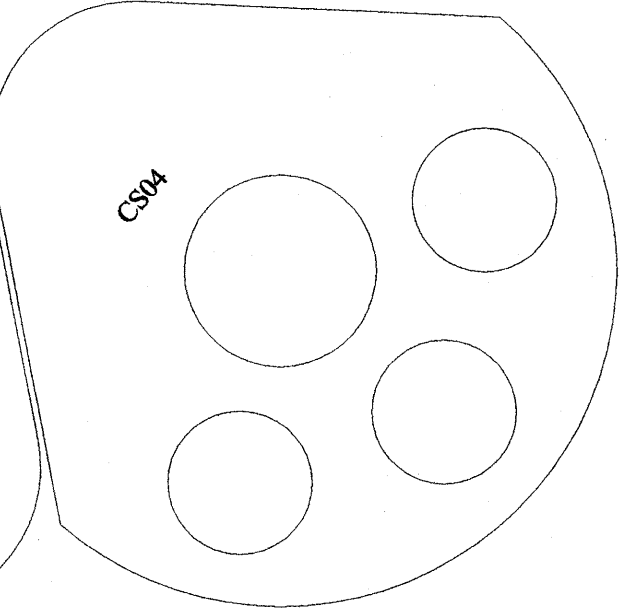
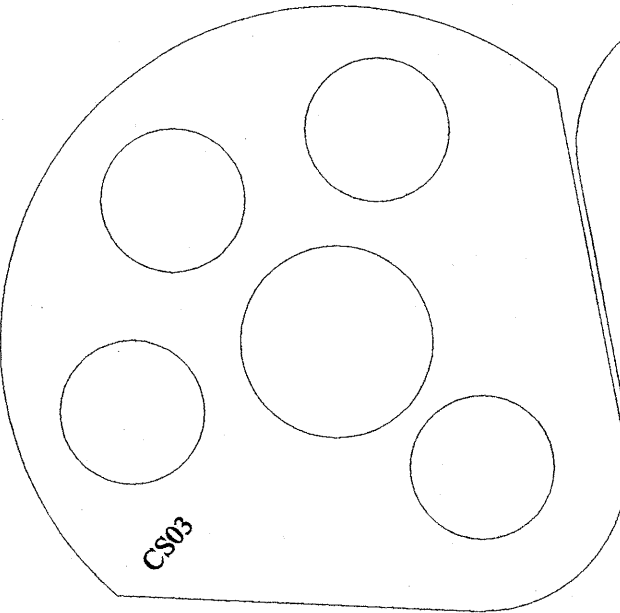
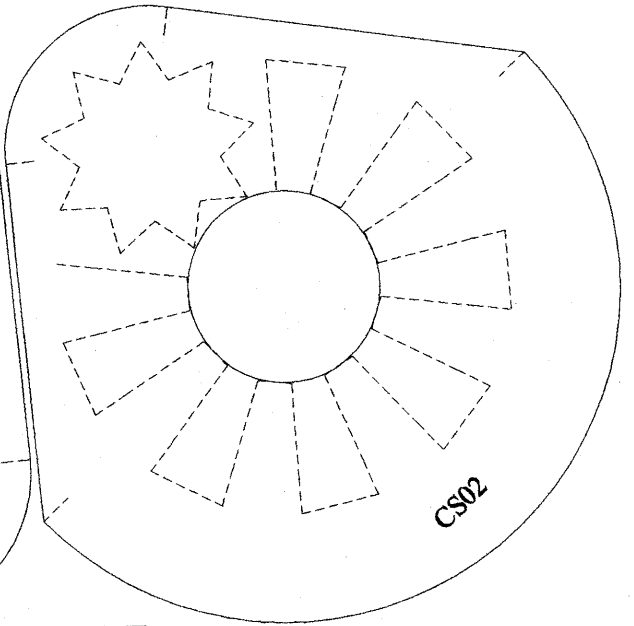
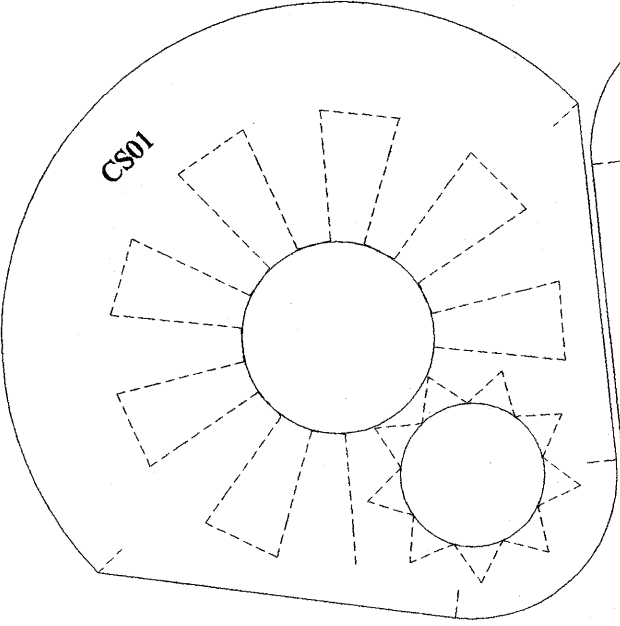
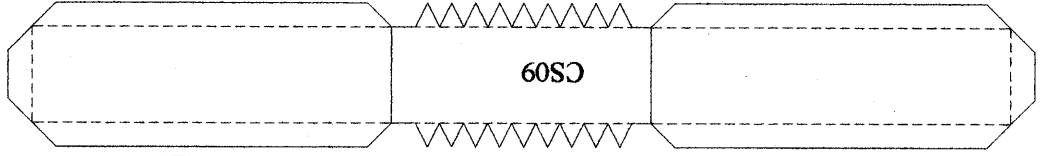
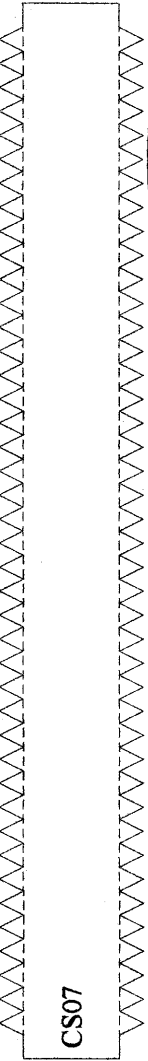
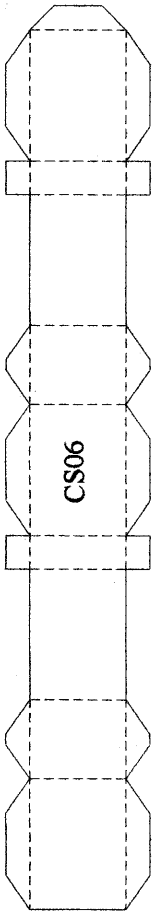
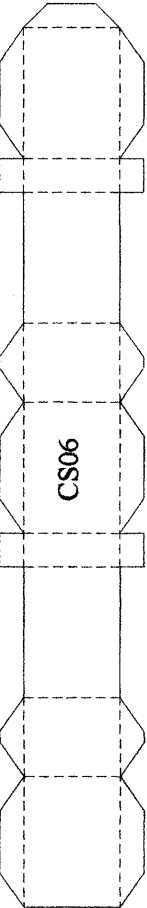
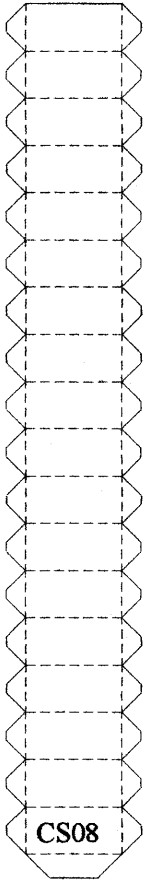

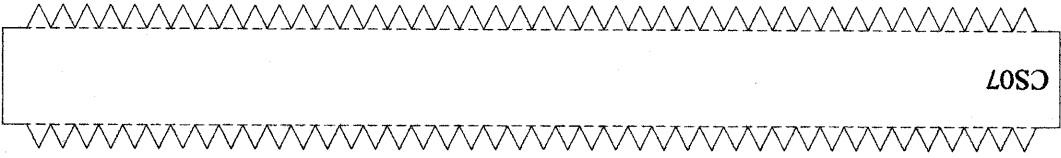
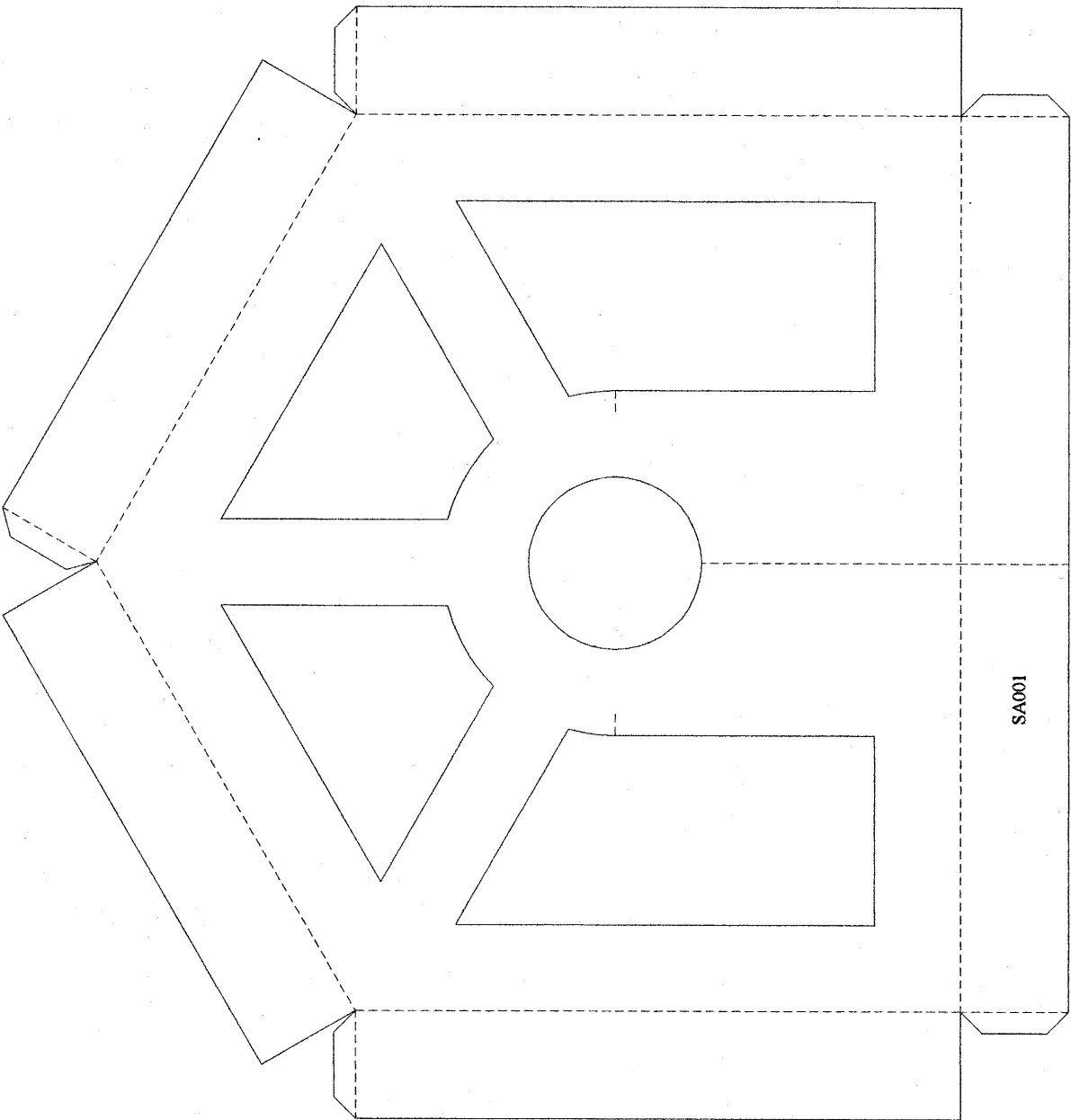
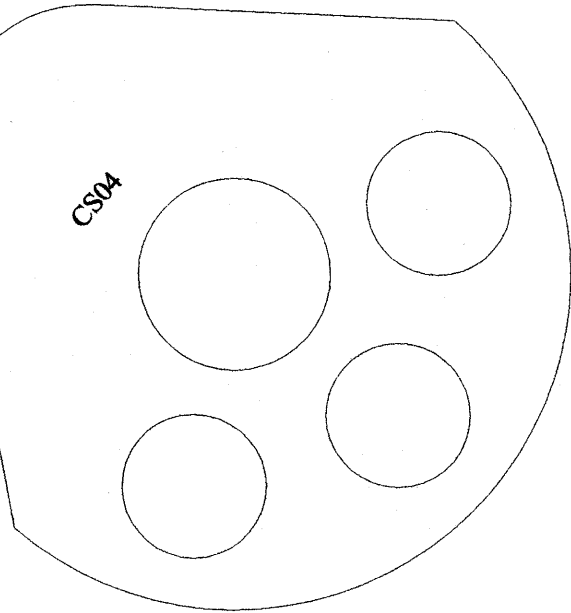
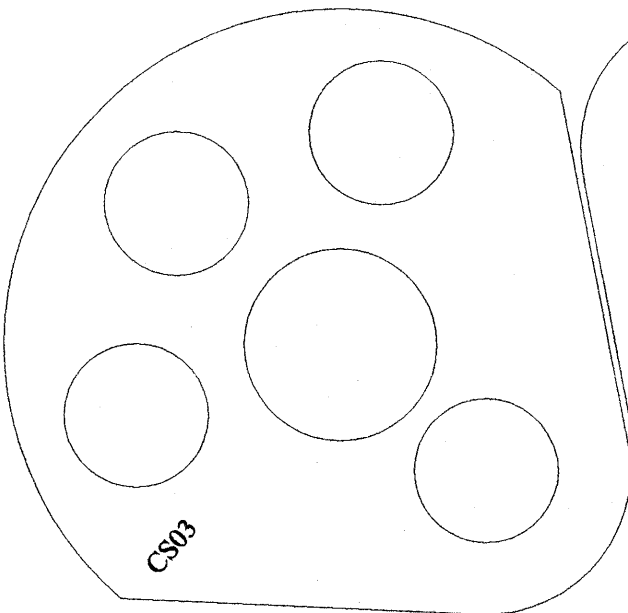
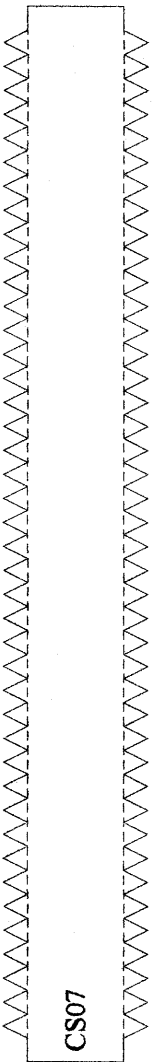
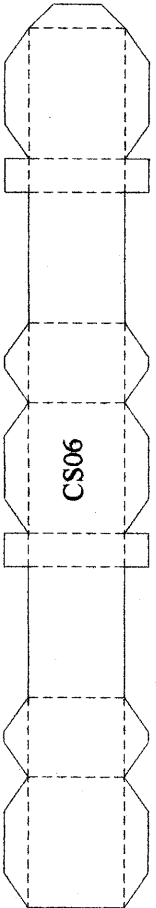
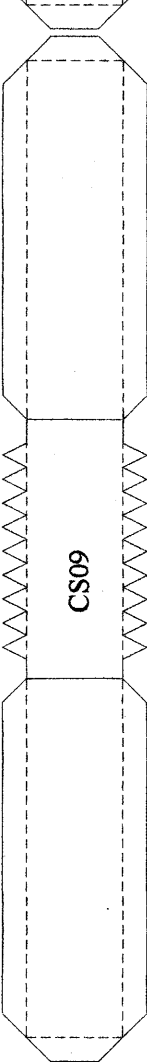
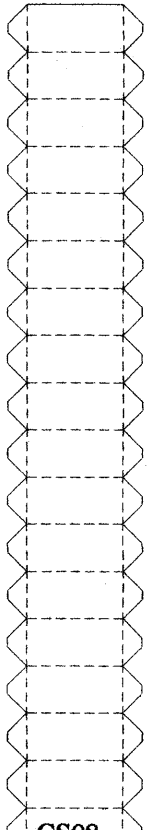

CS07

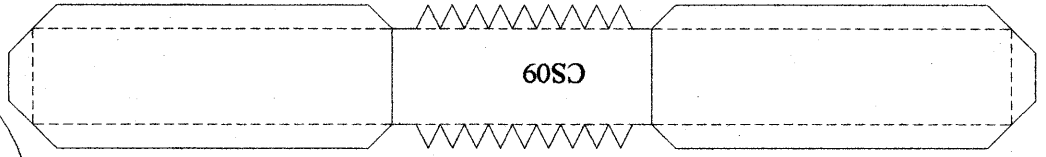
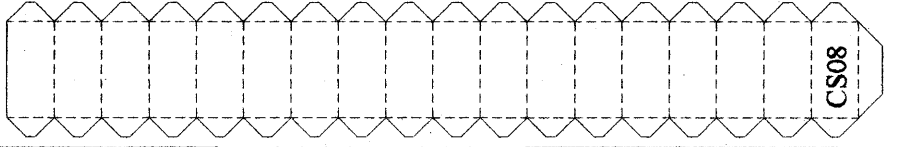
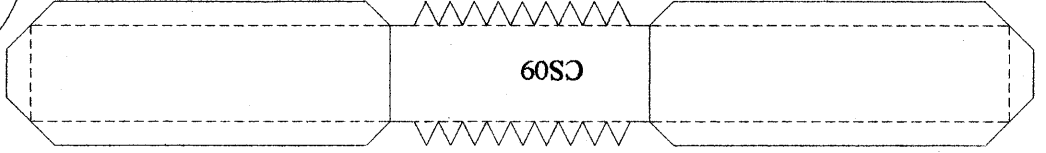
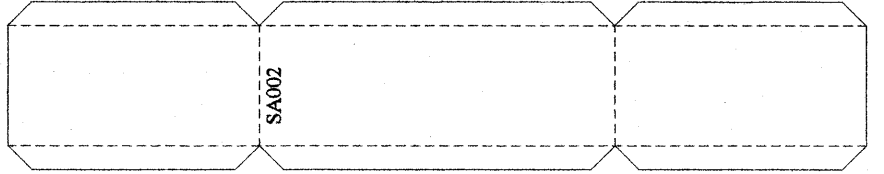
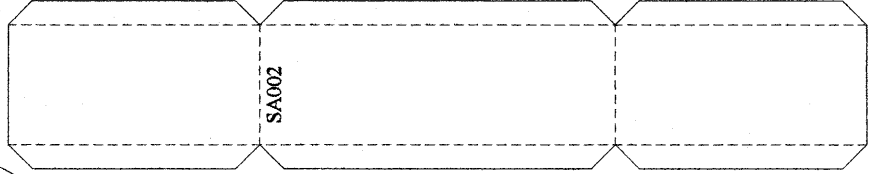
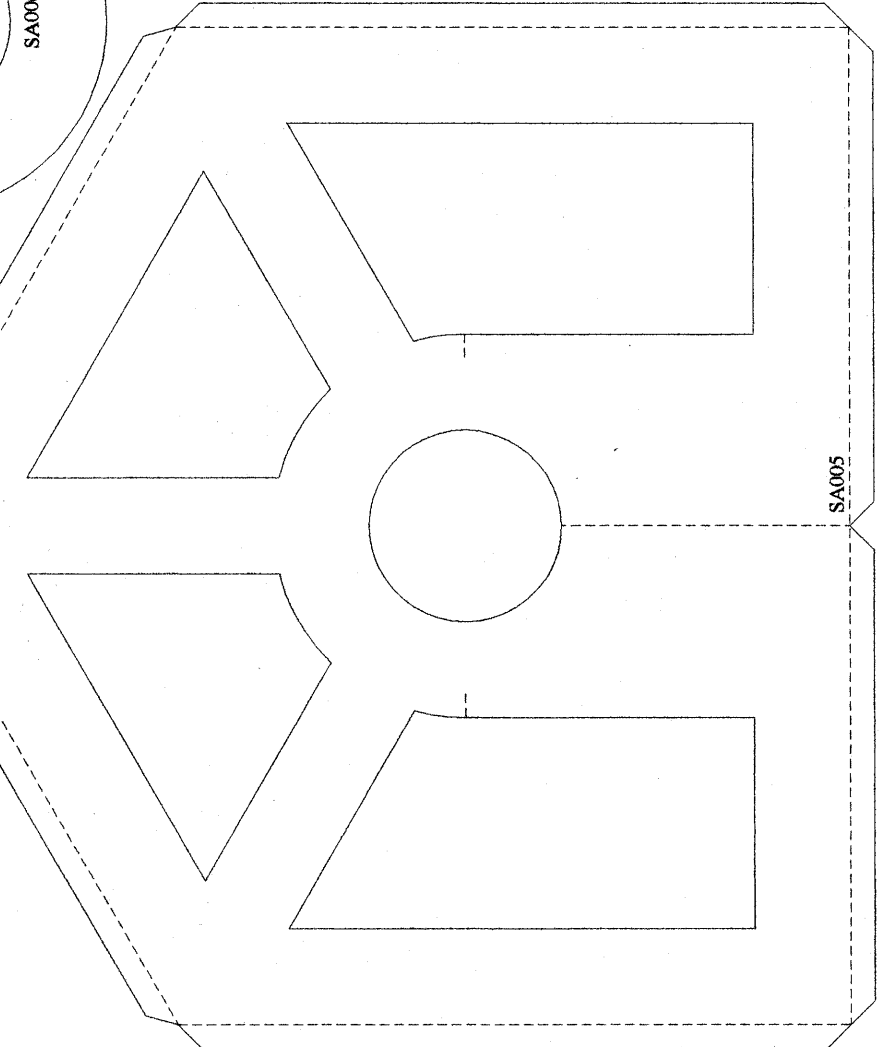
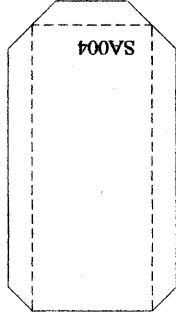
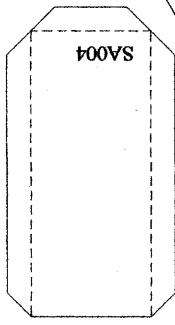
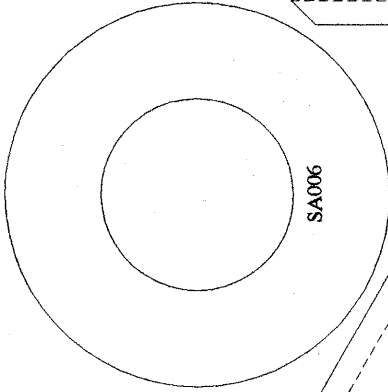
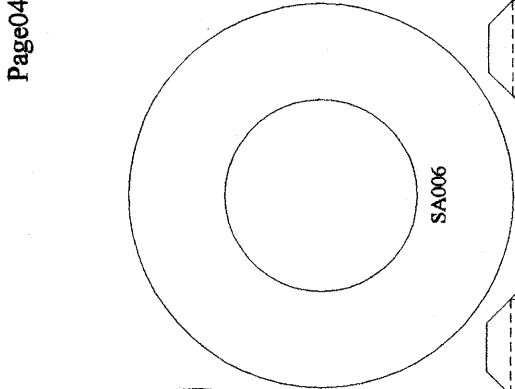
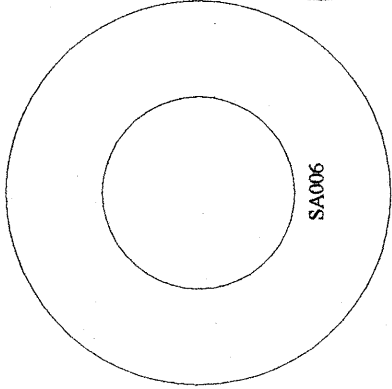
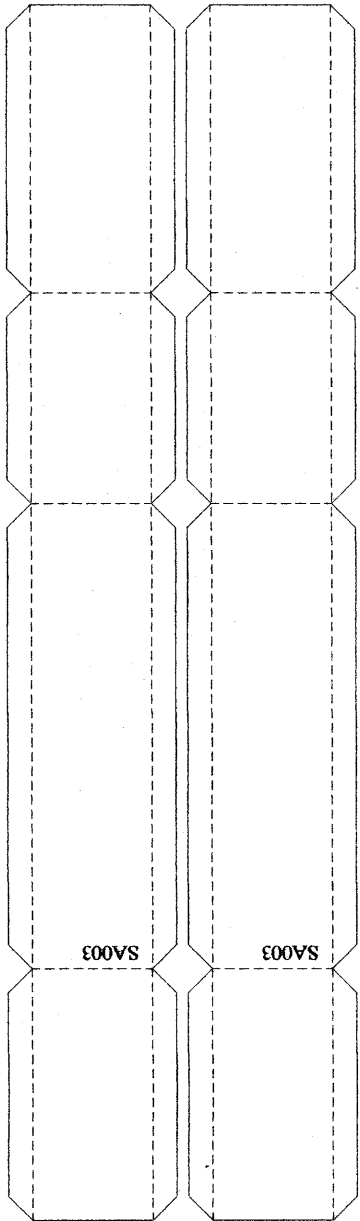



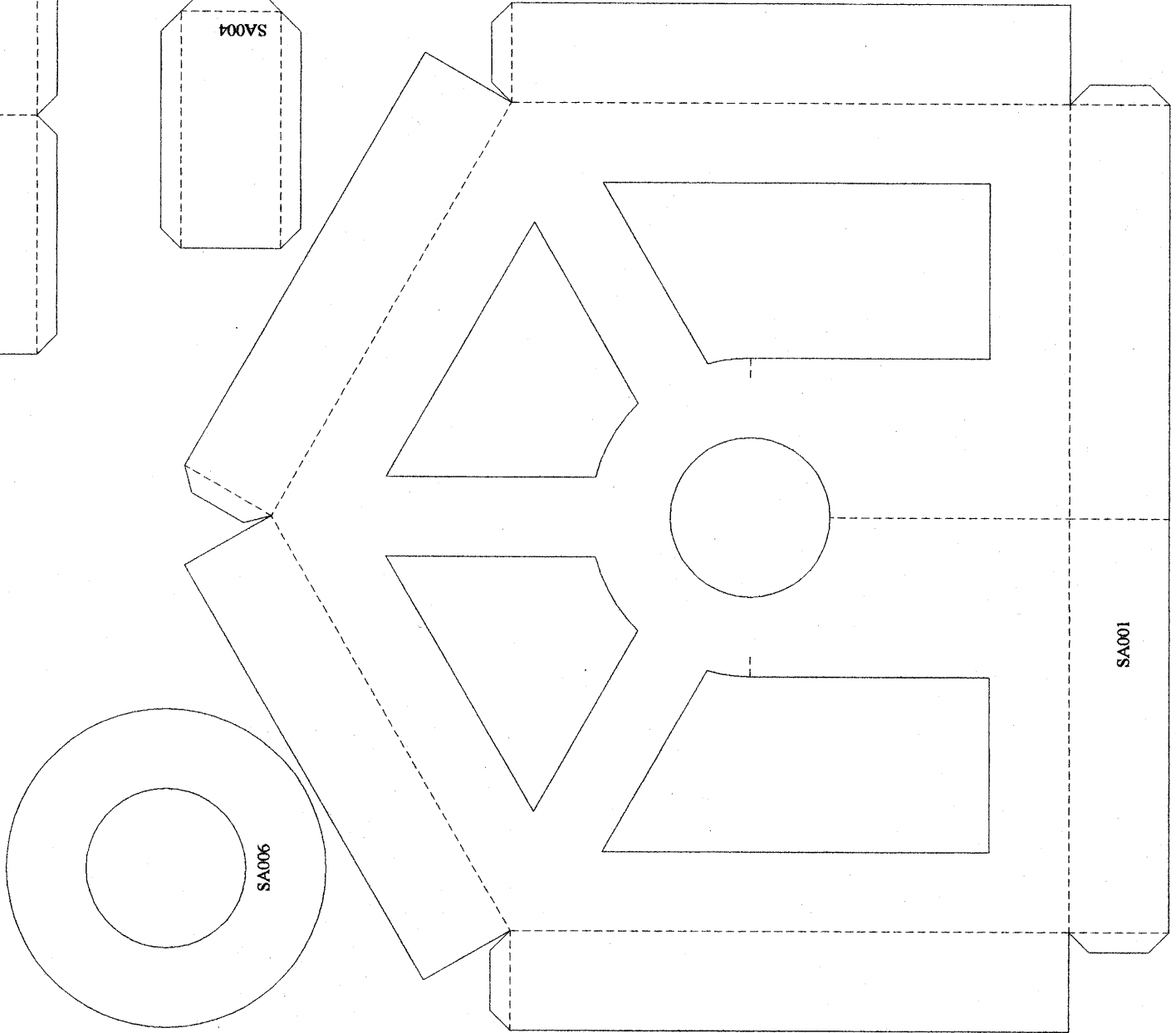
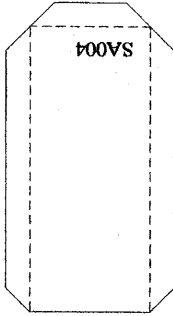
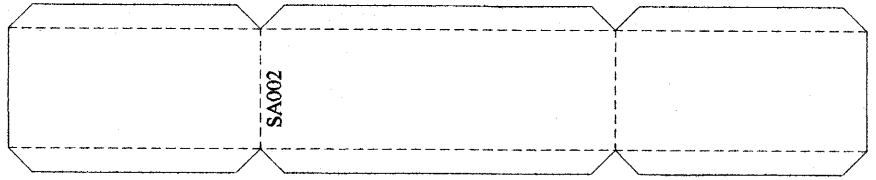
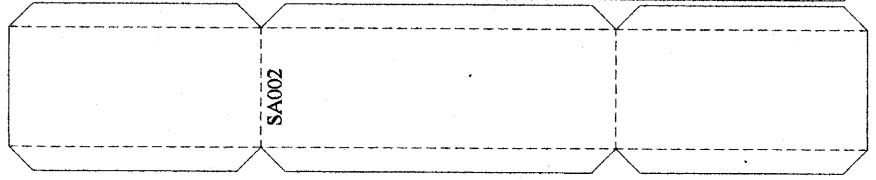
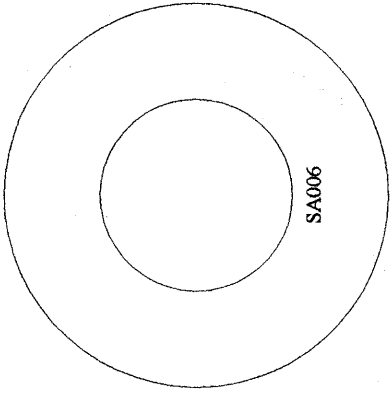
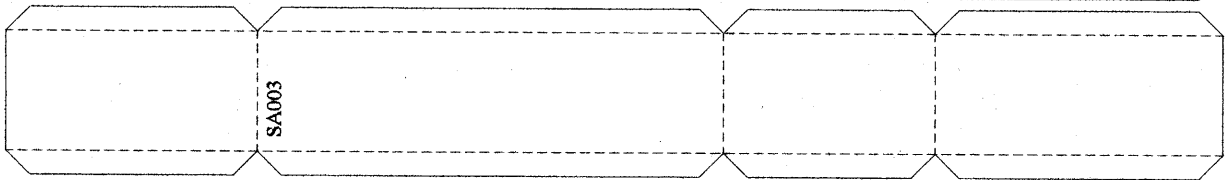
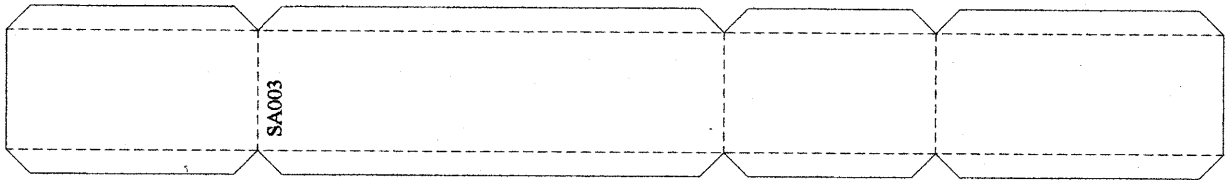
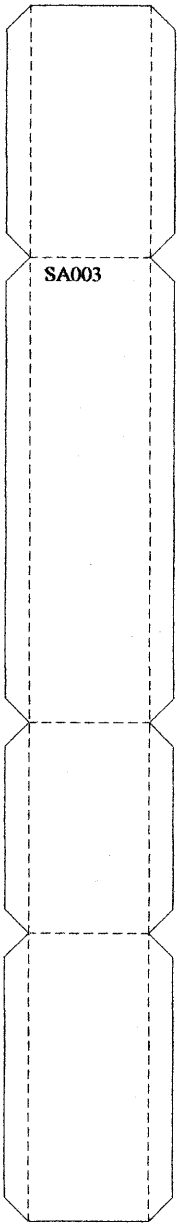

H024

H1

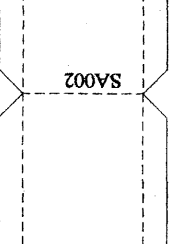
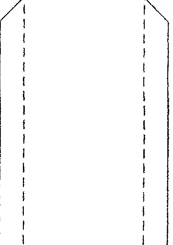
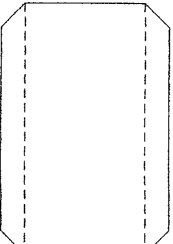
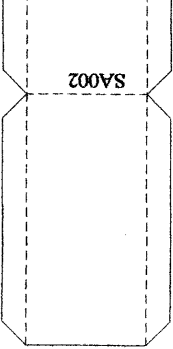
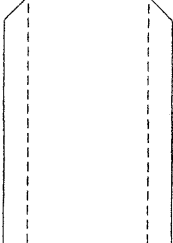
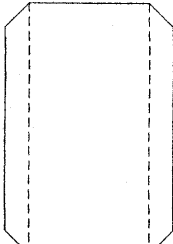
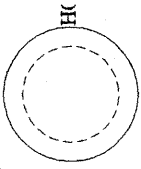
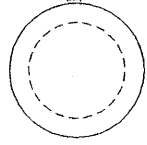

SA002

SA002



SC002

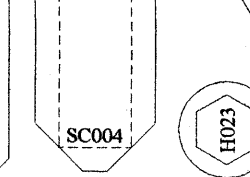
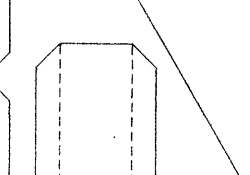
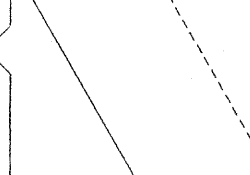
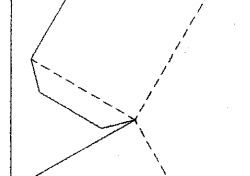
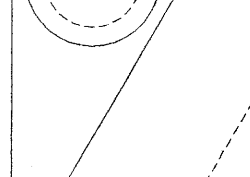
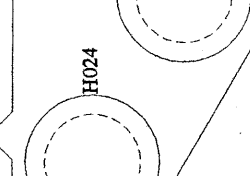
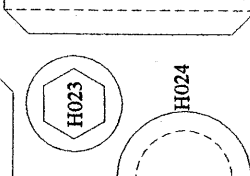
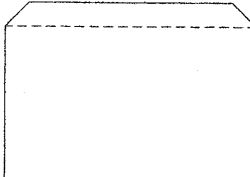
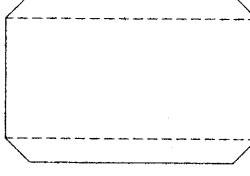
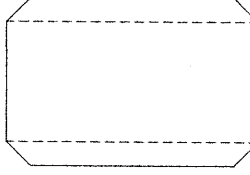
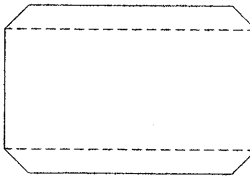

SA003

SA003

SA003

SB002

SA003

SA003

SA003

SA003

SA003

SA003

SA003



SC004



H023

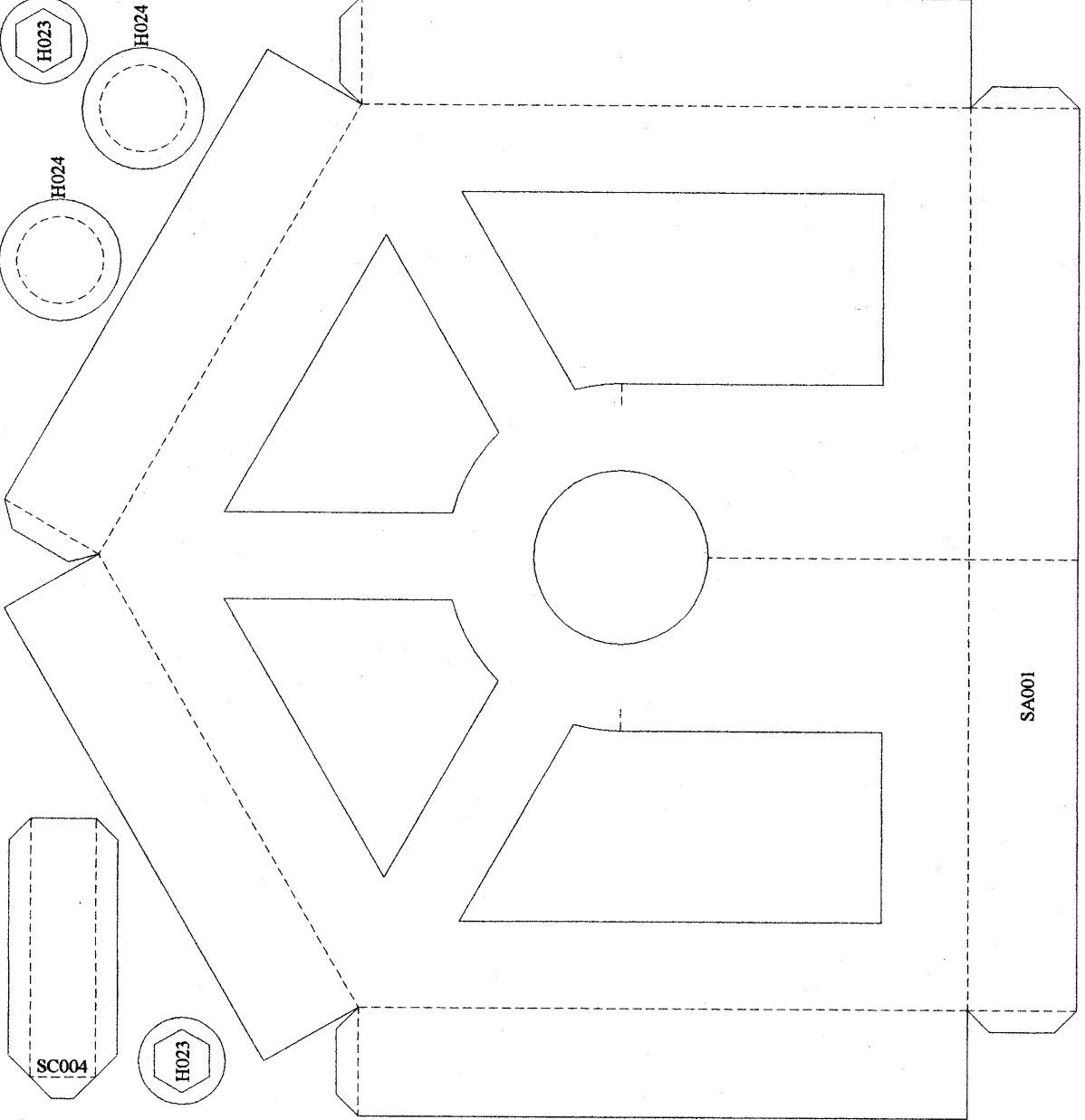

SA001

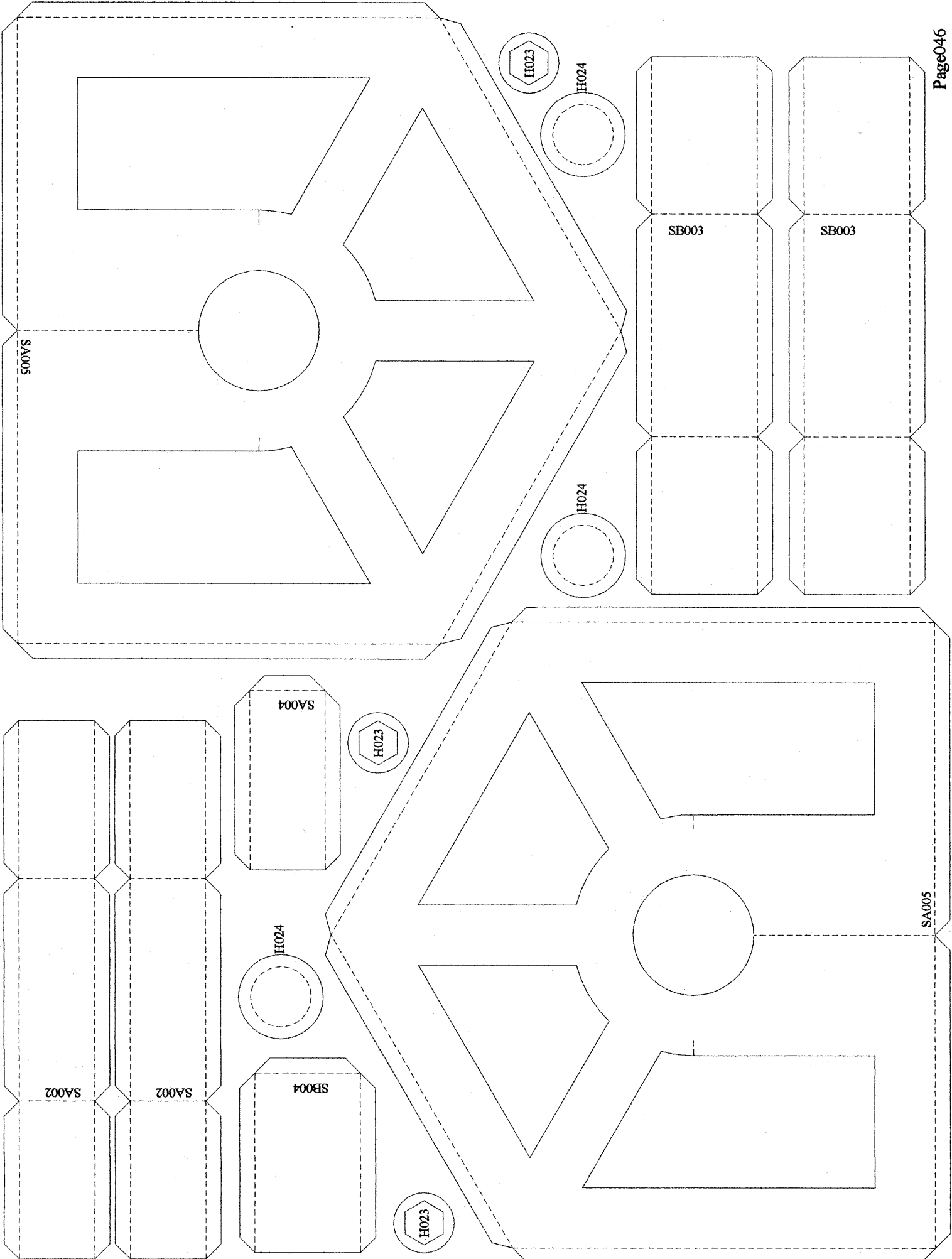

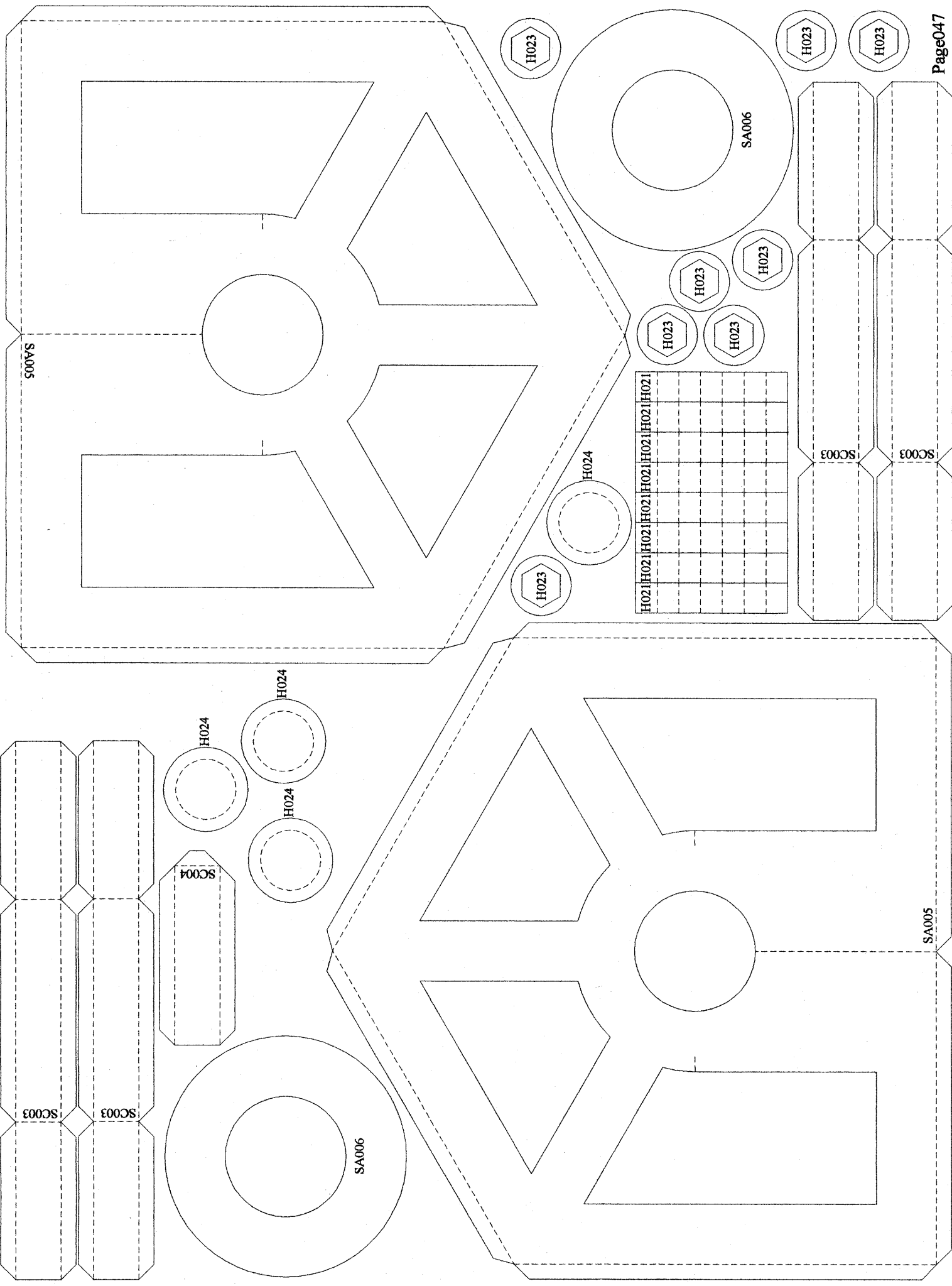

S000V

H023

H023

H023

SA006

H023

H023

H023

H023

H021|H021|H021|H021|H021|H021|H021|H021|H021|H021

H024

H023

SC003

SC003

H024

H024

H024

SC004

SC003

SC003

SA006

SA005

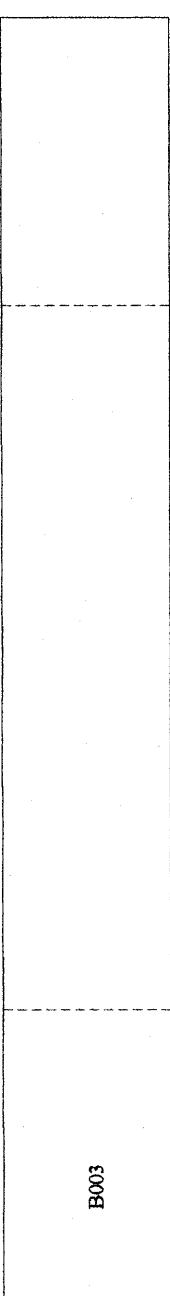
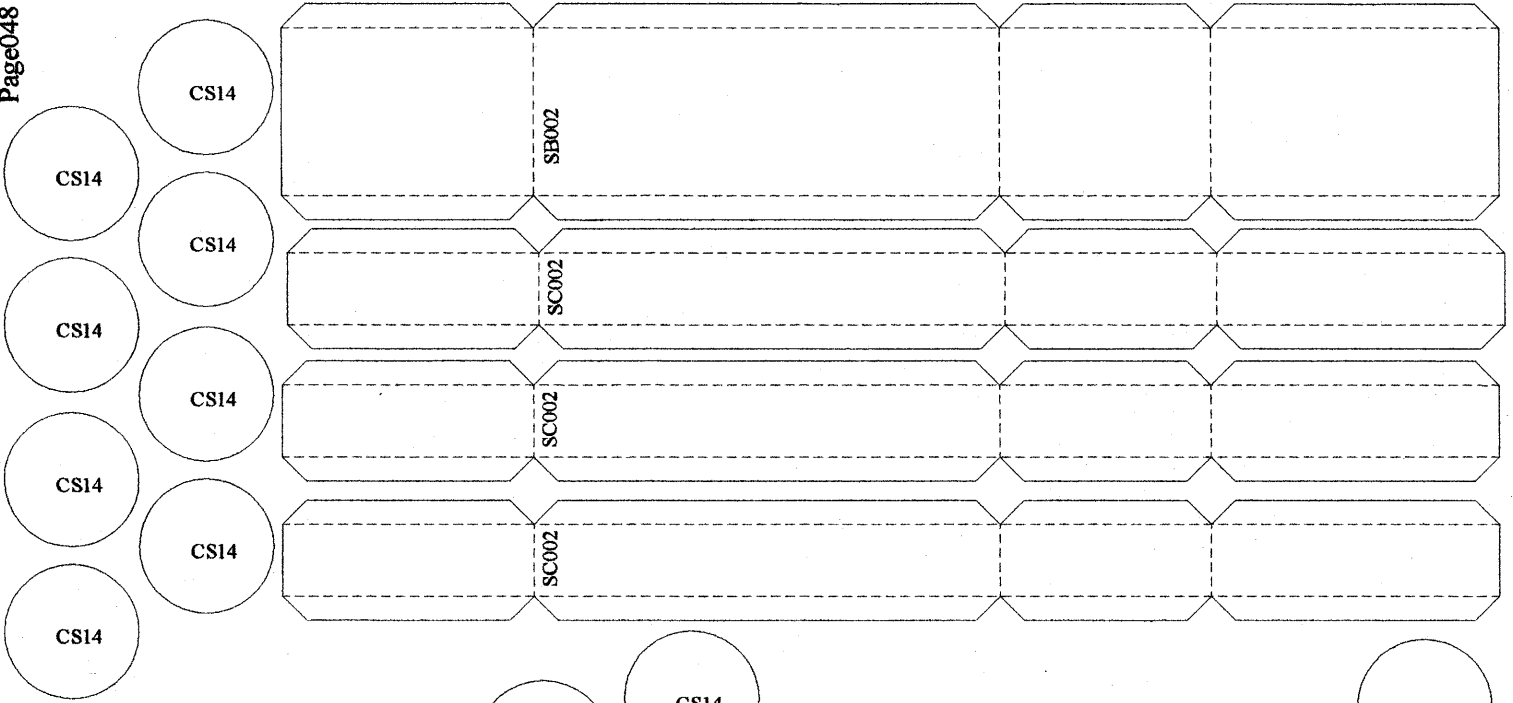

H02	H02	H02	H02	H02	H02	H02	H02	H02	H02
H02	H02	H02	H02	H02	H02	H02	H02	H02	H02
H02	H02	H02	H02	H02	H02	H02	H02	H02	H02
H02	H02	H02	H02	H02	H02	H02	H02	H02	H02
H02	H02	H02	H02	H02	H02	H02	H02	H02	H02
H02	H02	H02	H02	H02	H02	H02	H02	H02	H02
H02	H02	H02	H02	H02	H02	H02	H02	H02	H02
H02	H02	H02	H02	H02	H02	H02	H02	H02	H02
H02	H02	H02	H02	H02	H02	H02	H02	H02	H02
H02	H02	H02	H02	H02	H02	H02	H02	H02	H02

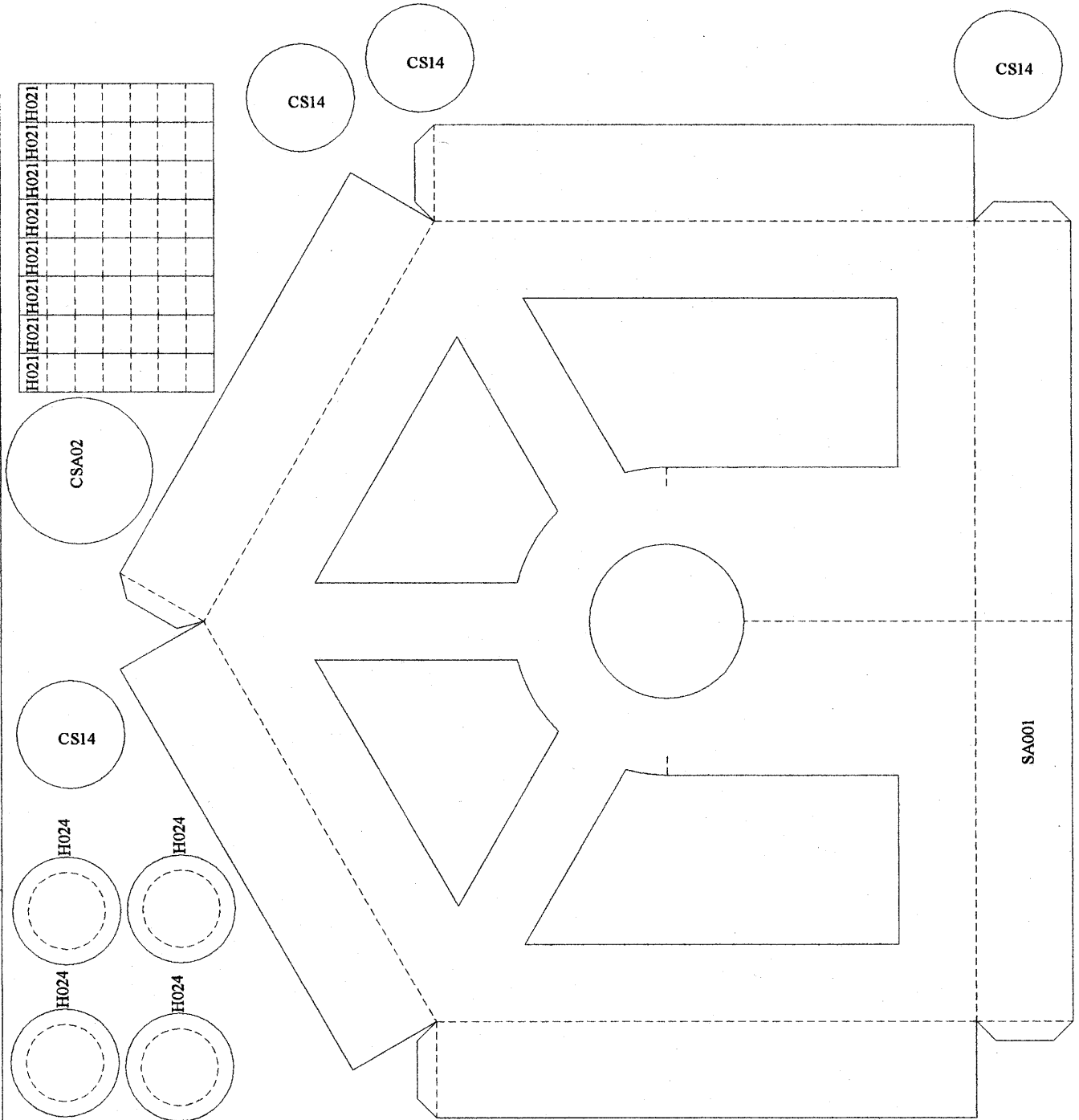

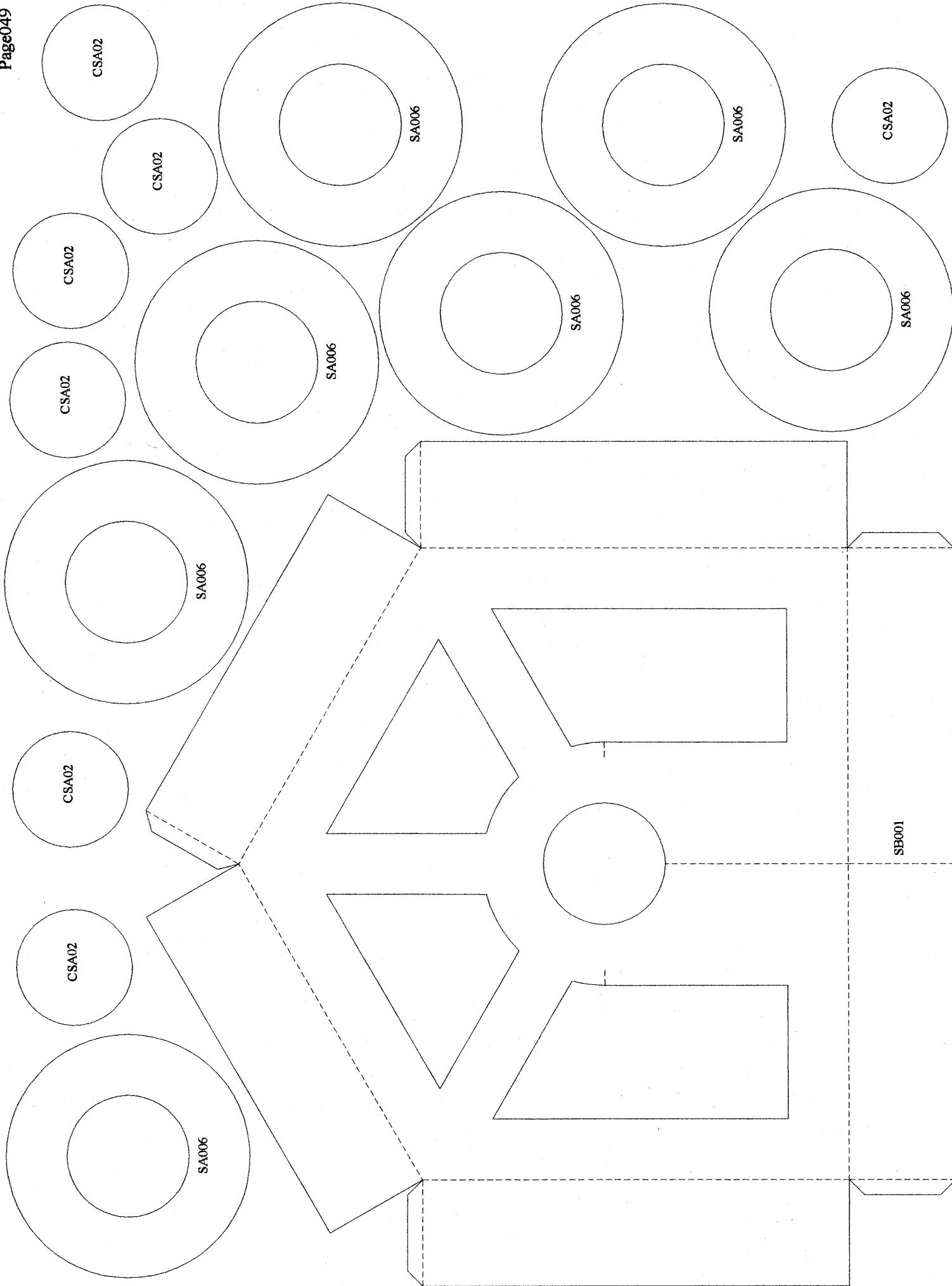

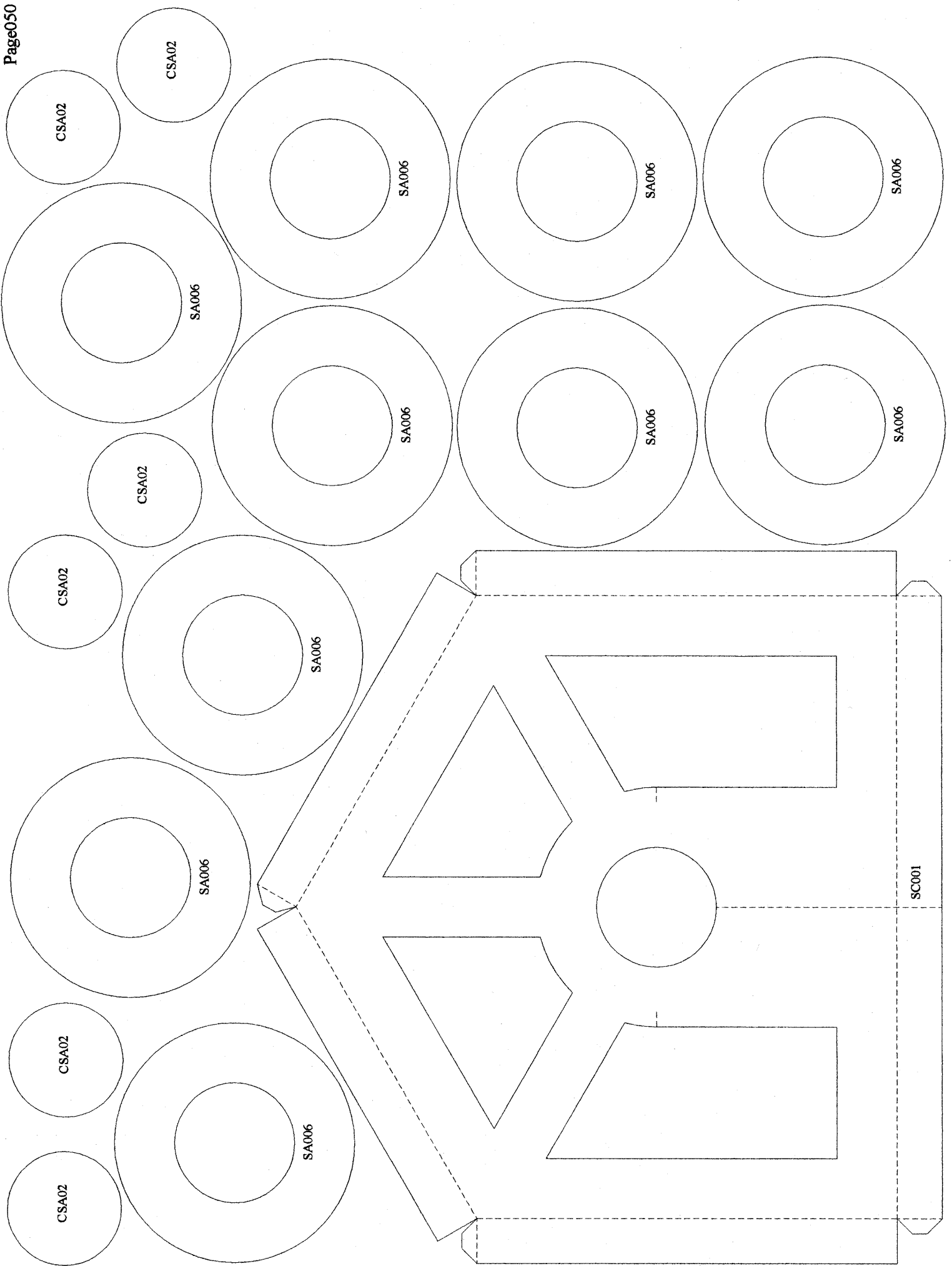





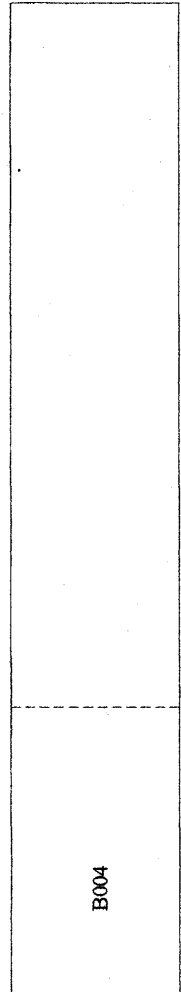
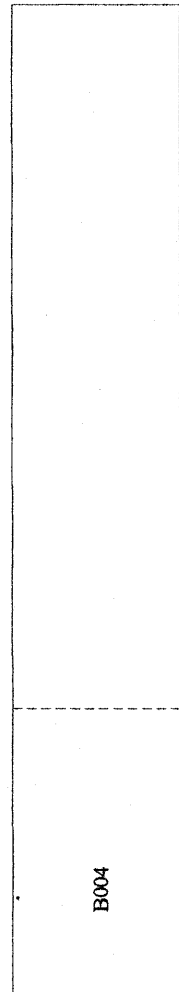
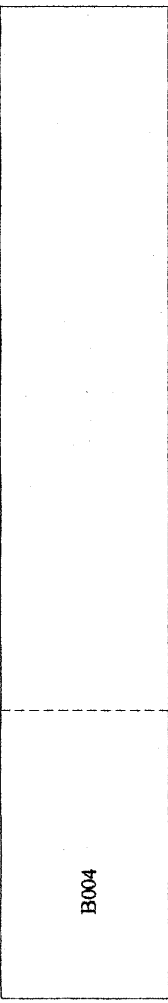

H020
H020

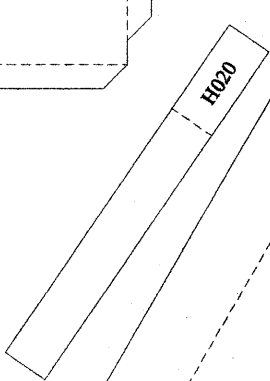

H020
H020
H020

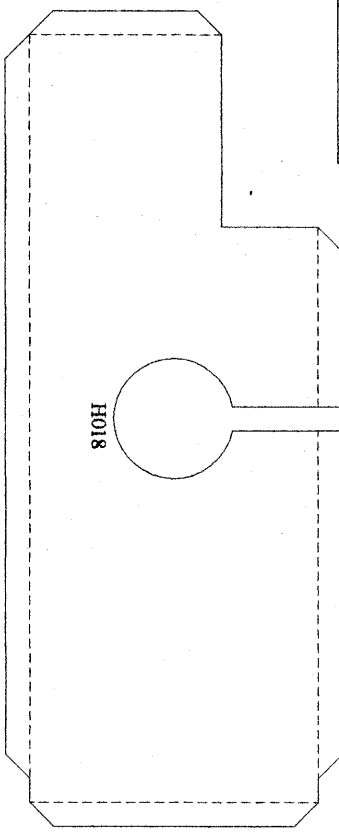

H020	H020
H020	H020
H020	H020

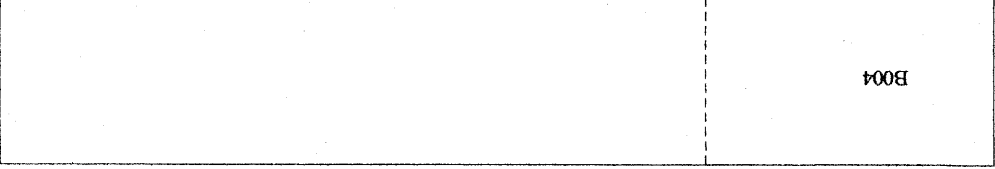
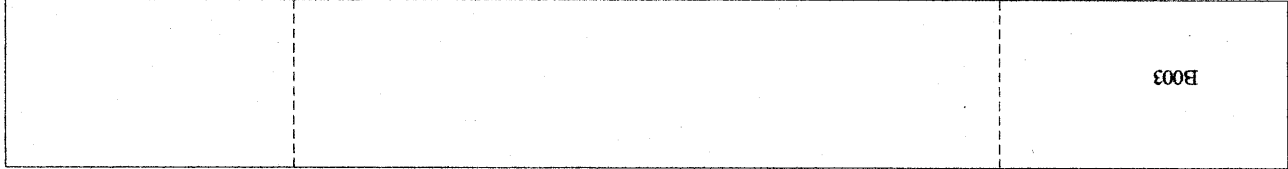
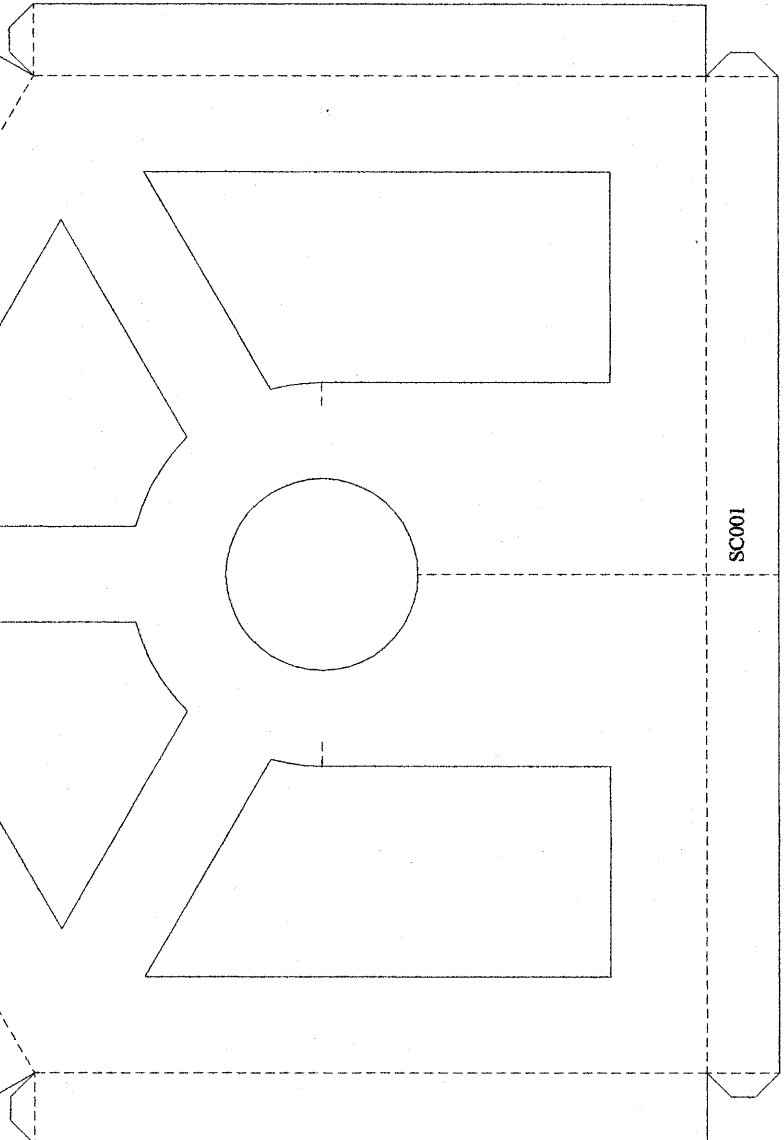
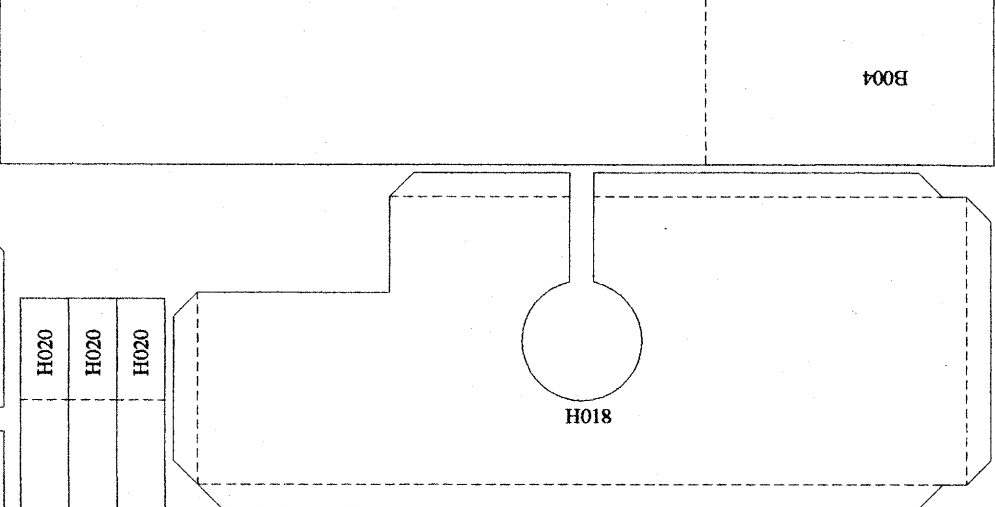

H020

H022

B001

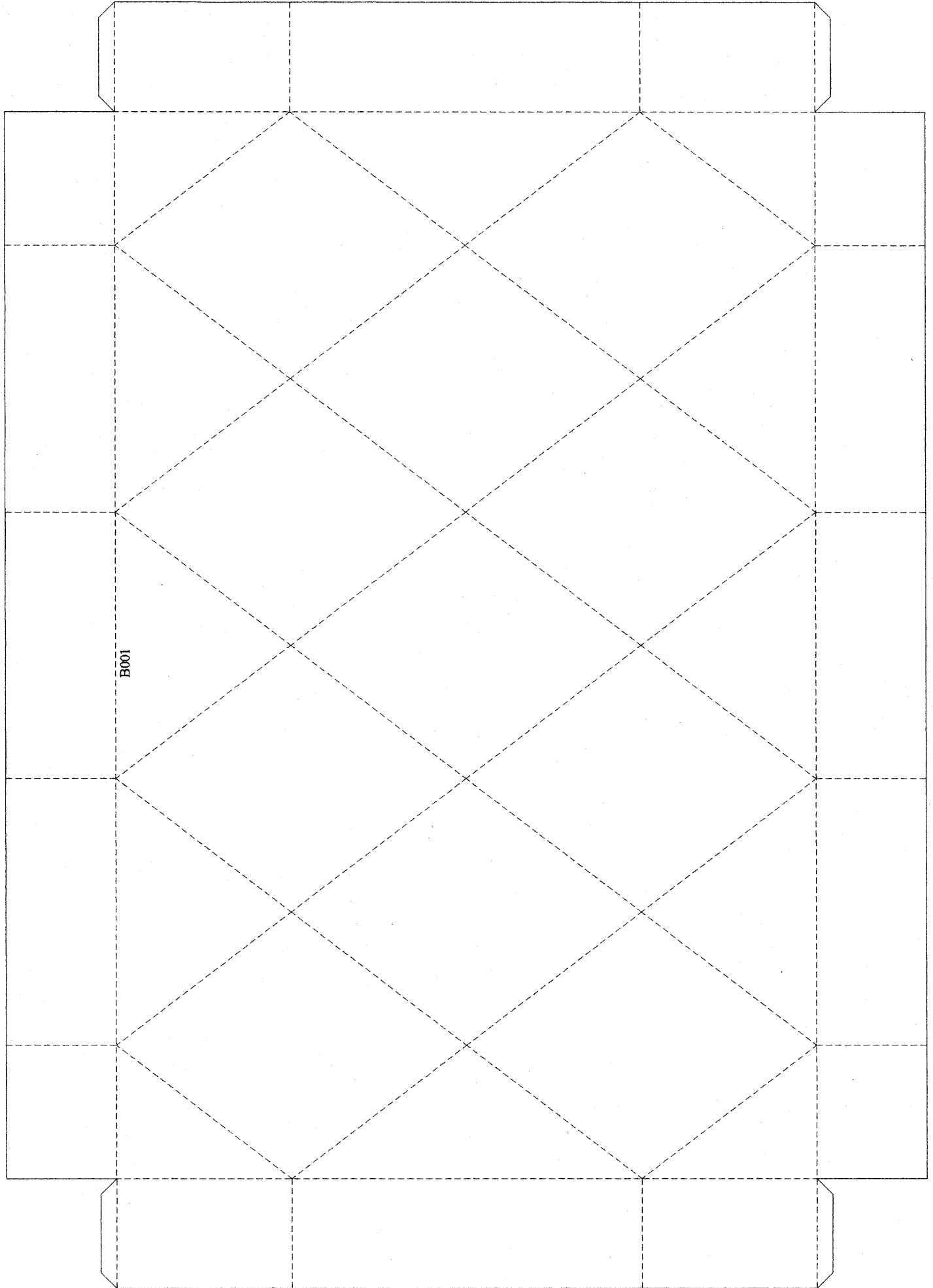

H020

H022

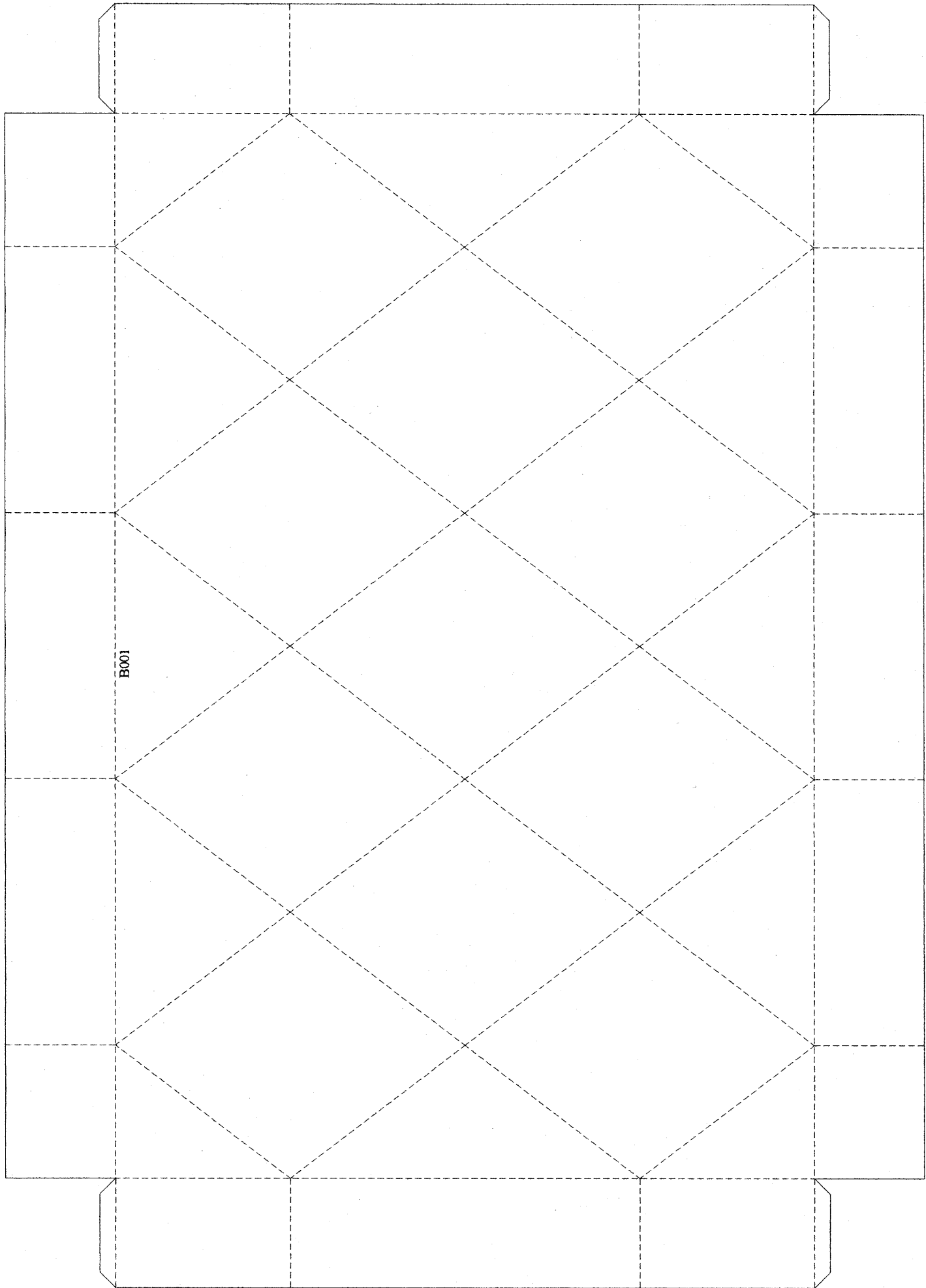

B001

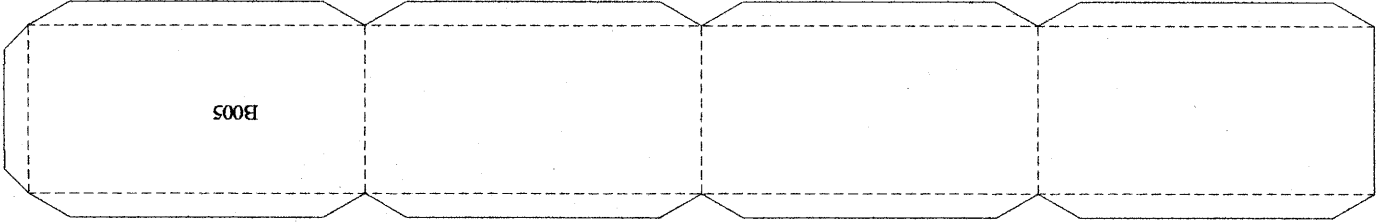

	H020
	H020
	H020

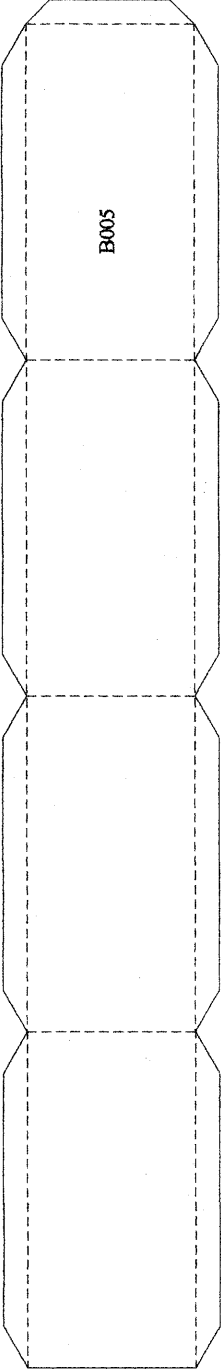

	H022
	H022

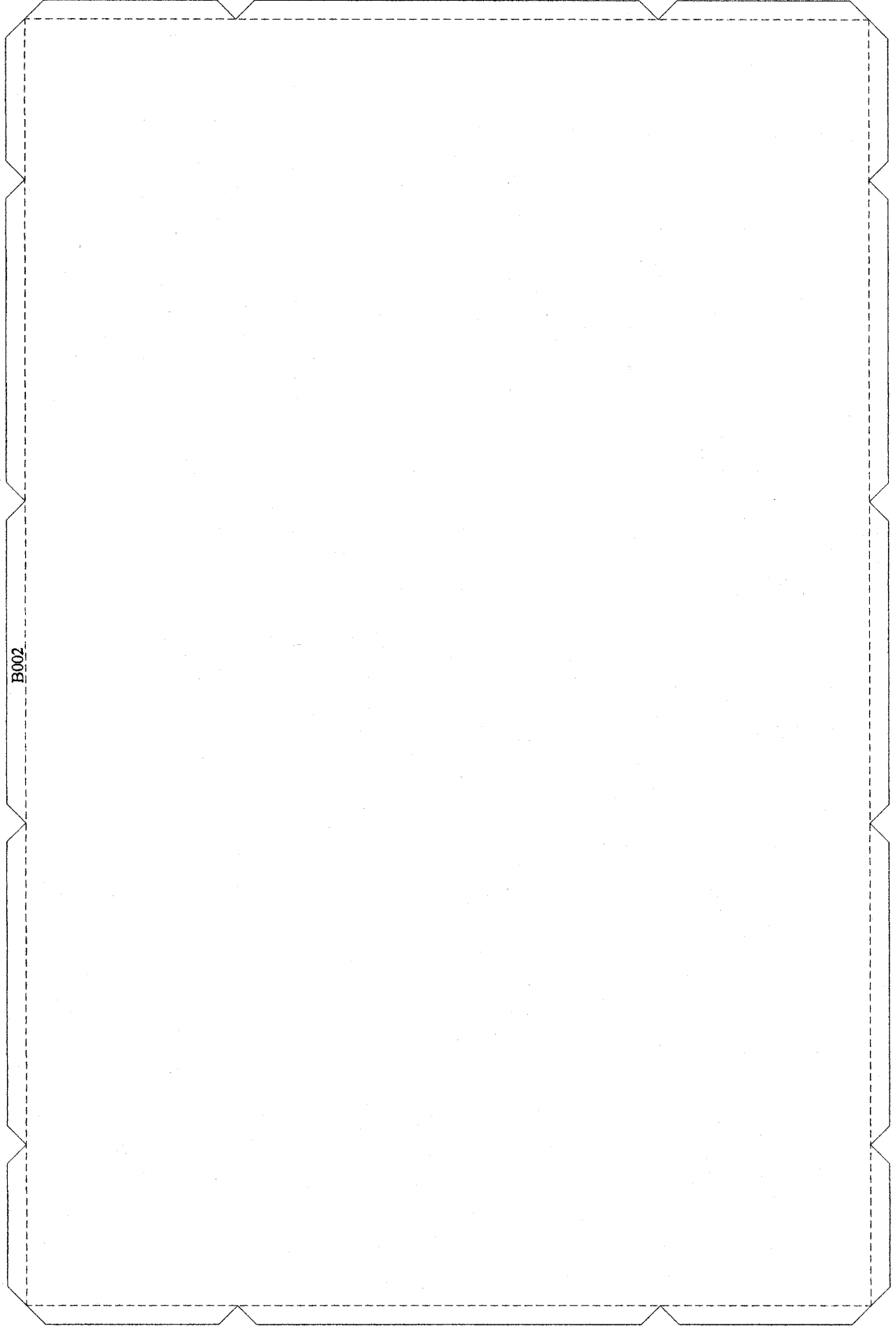

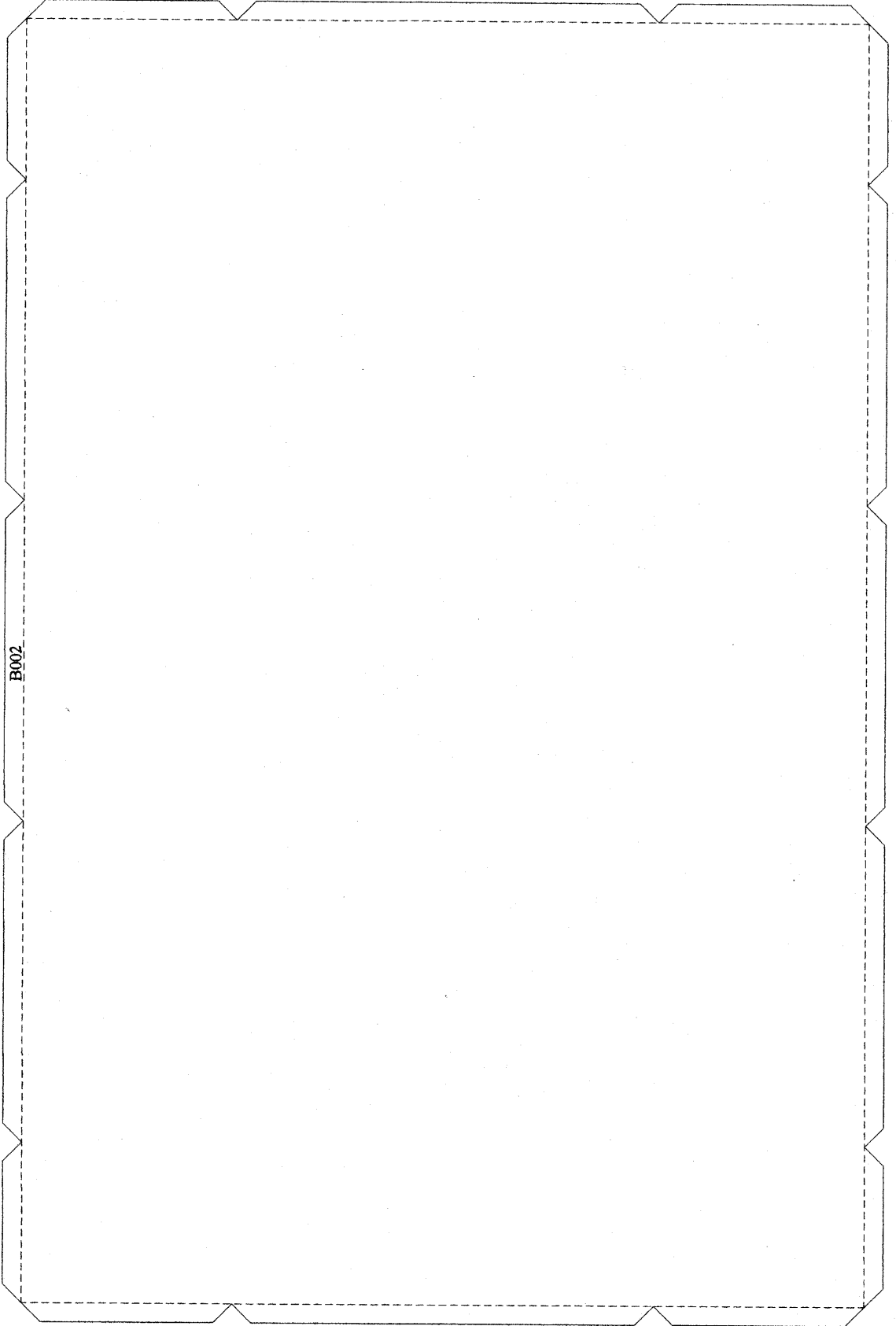
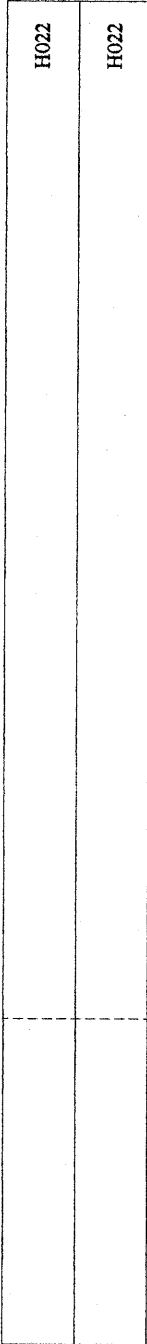
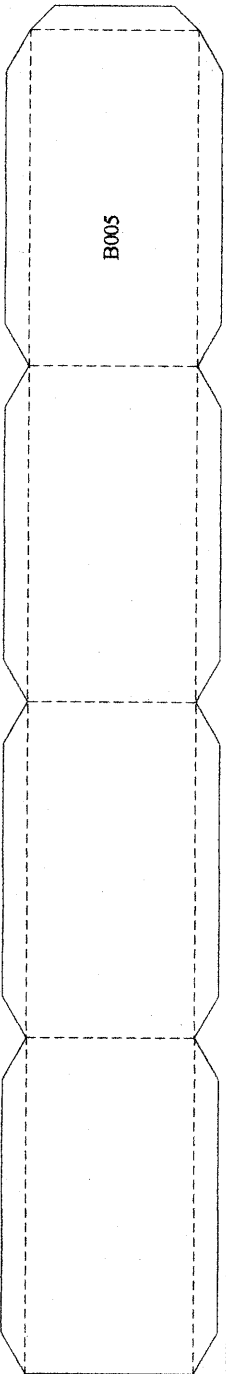
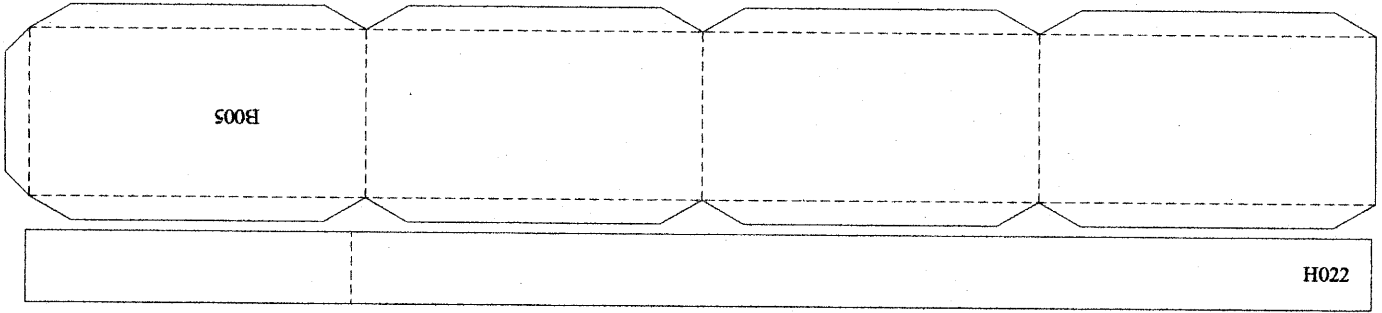

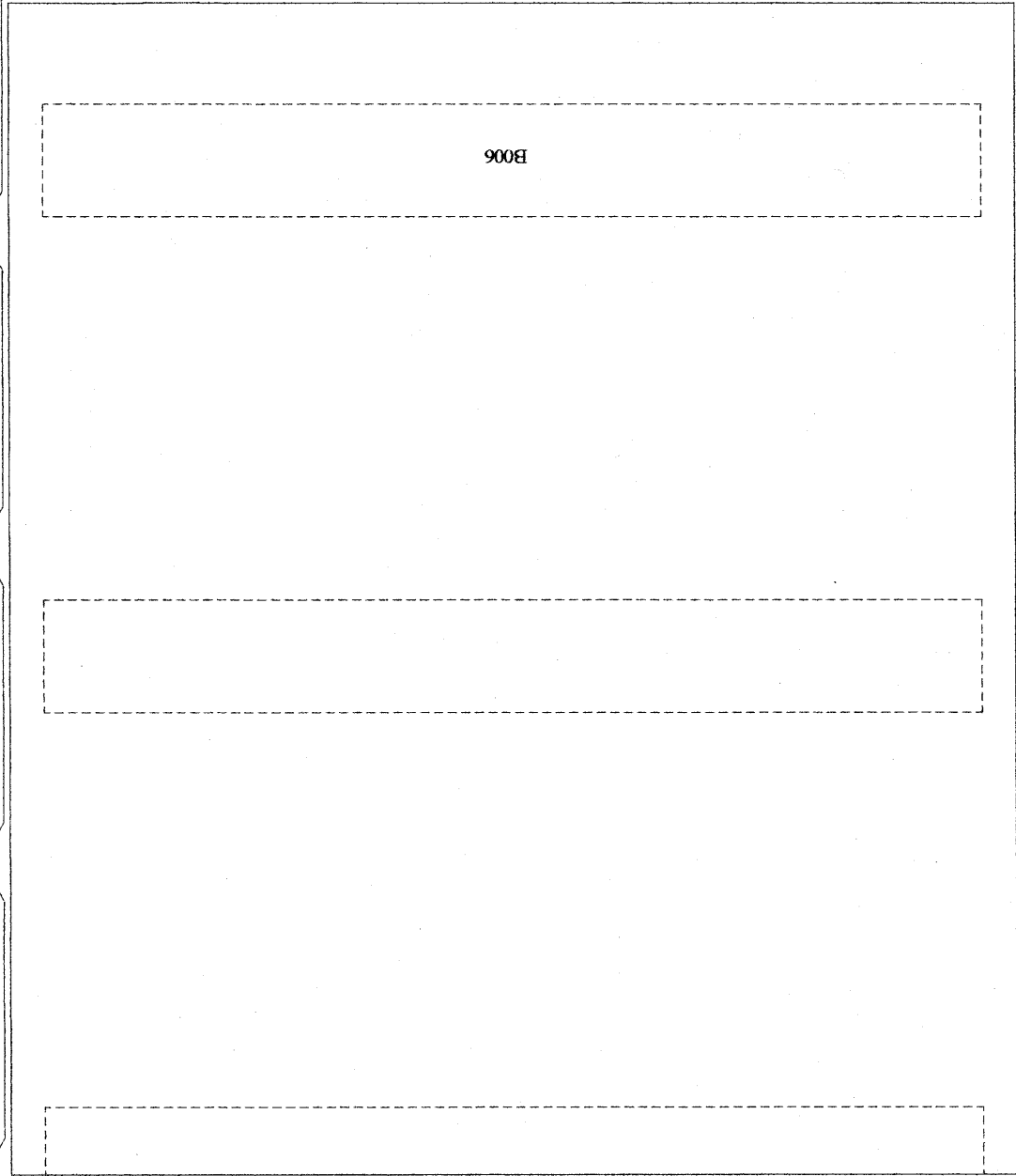
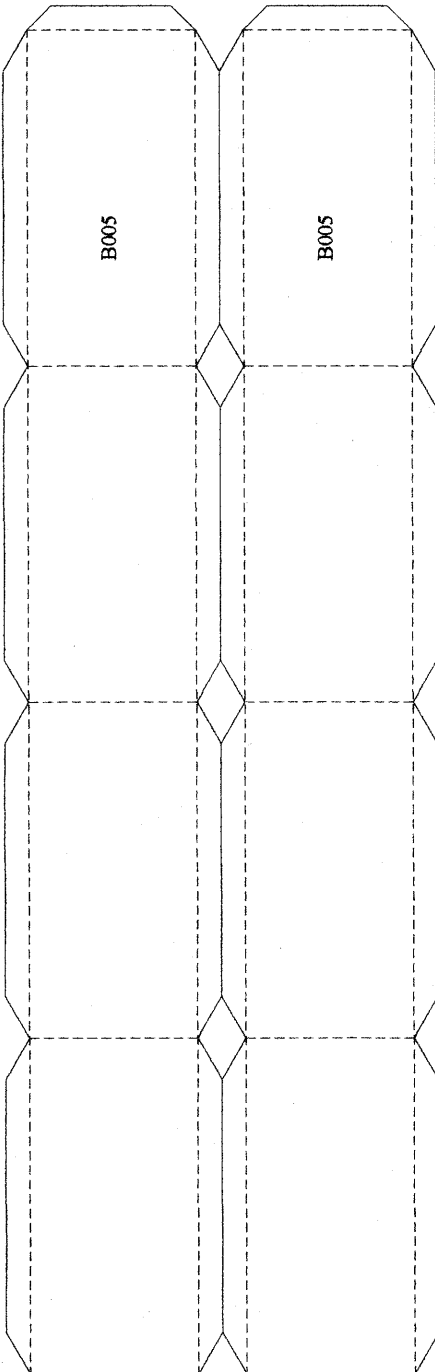
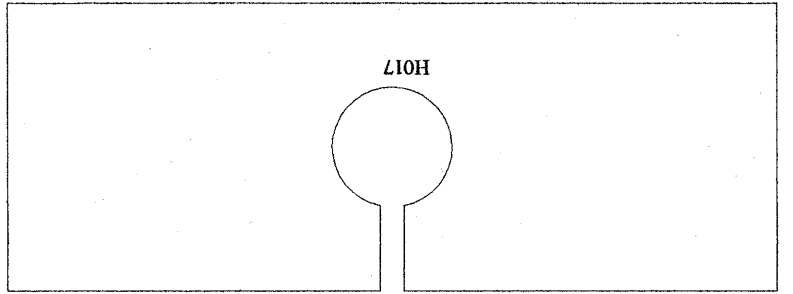
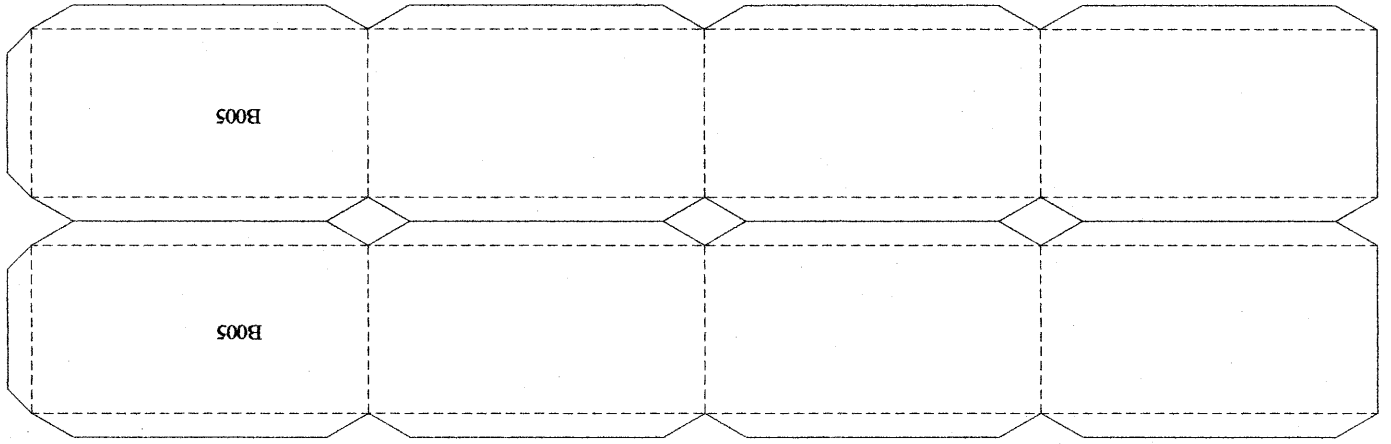

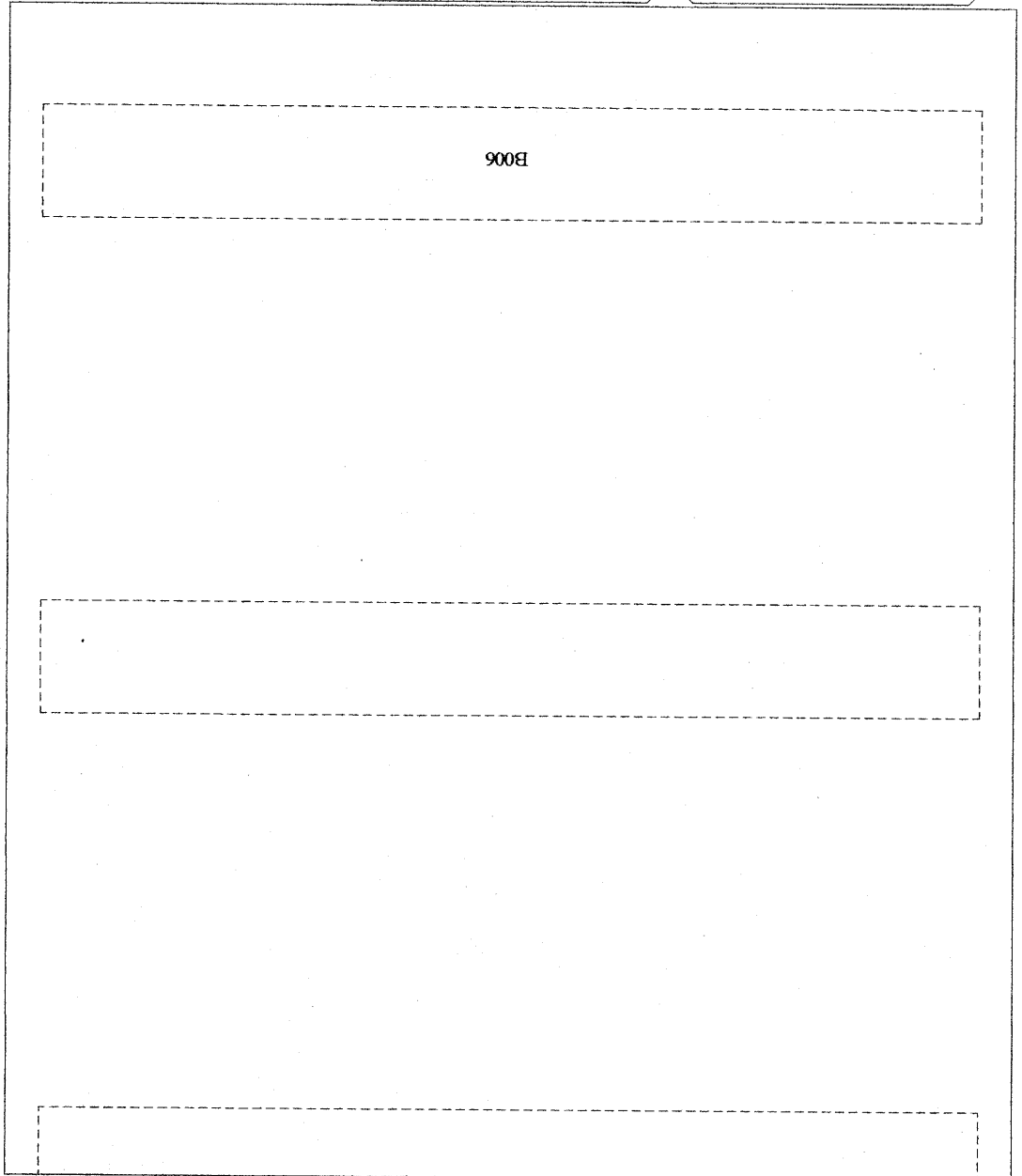
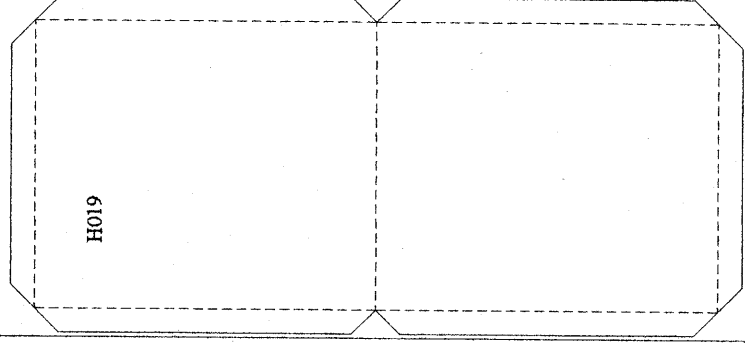
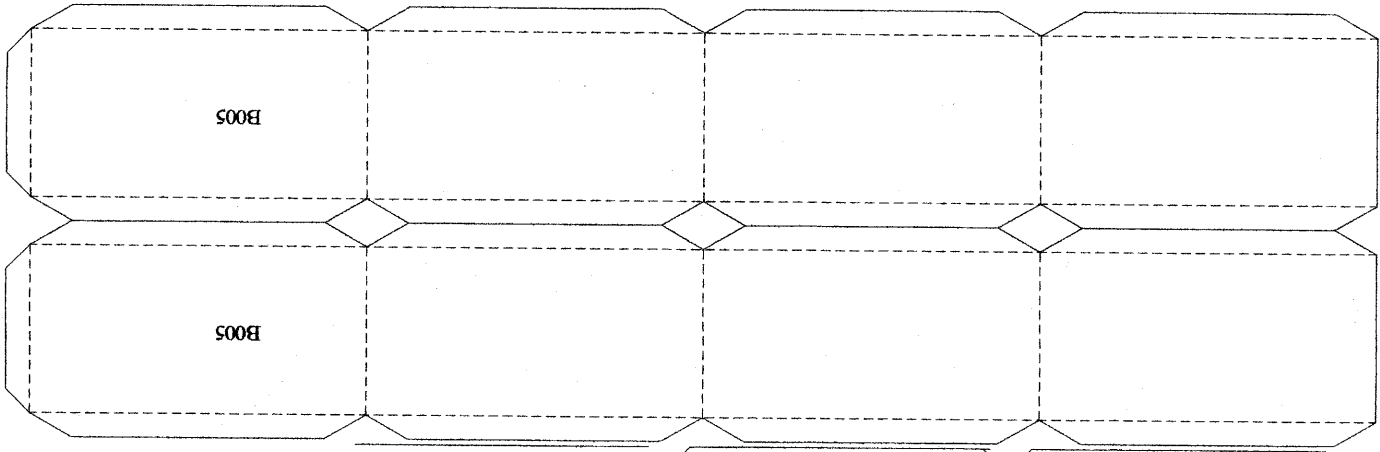
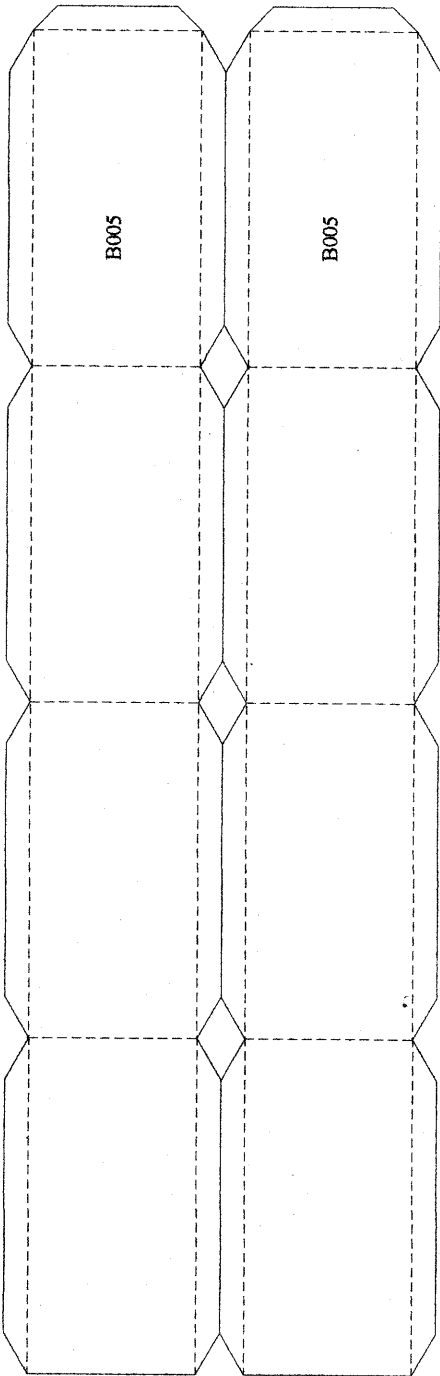

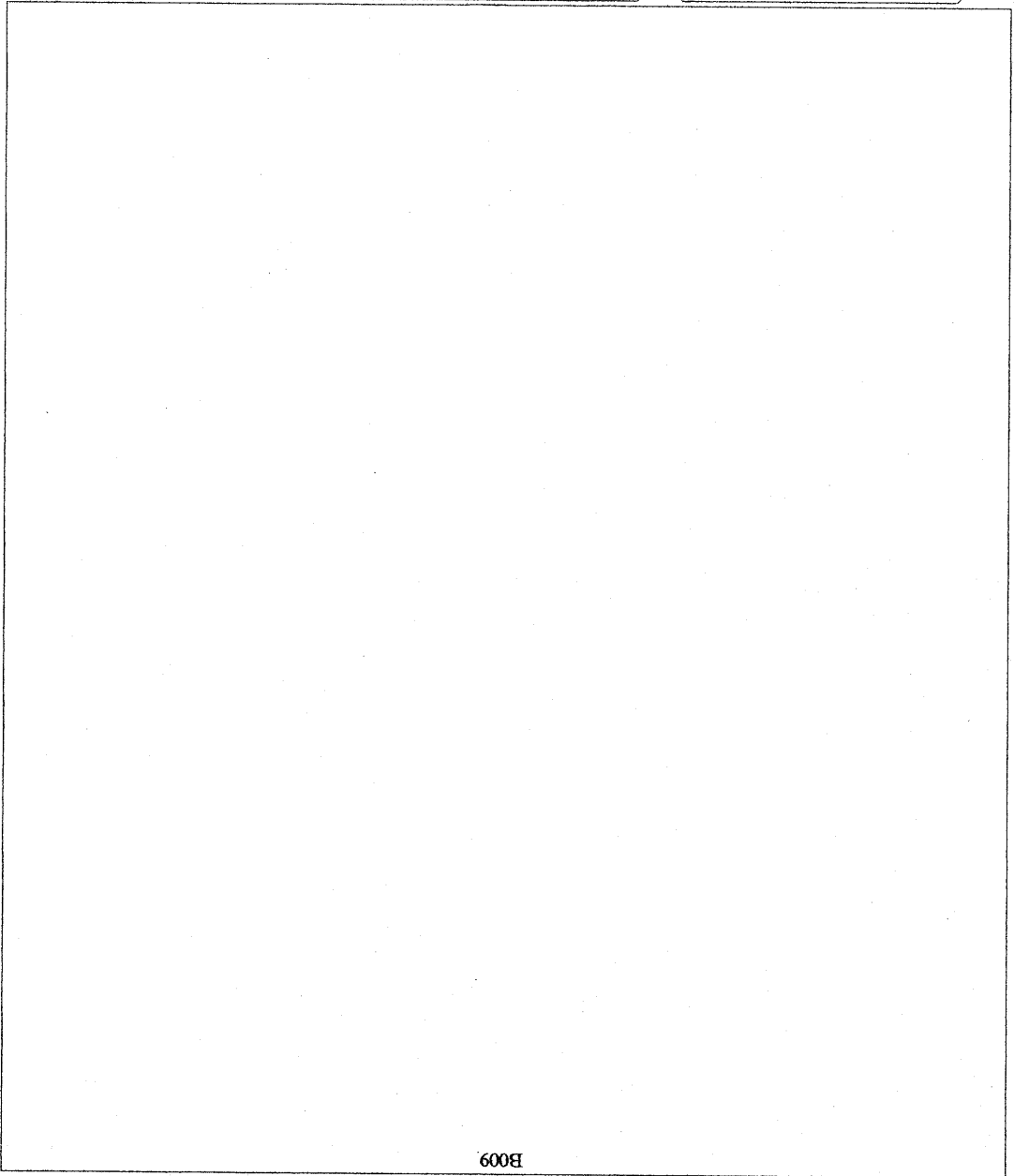
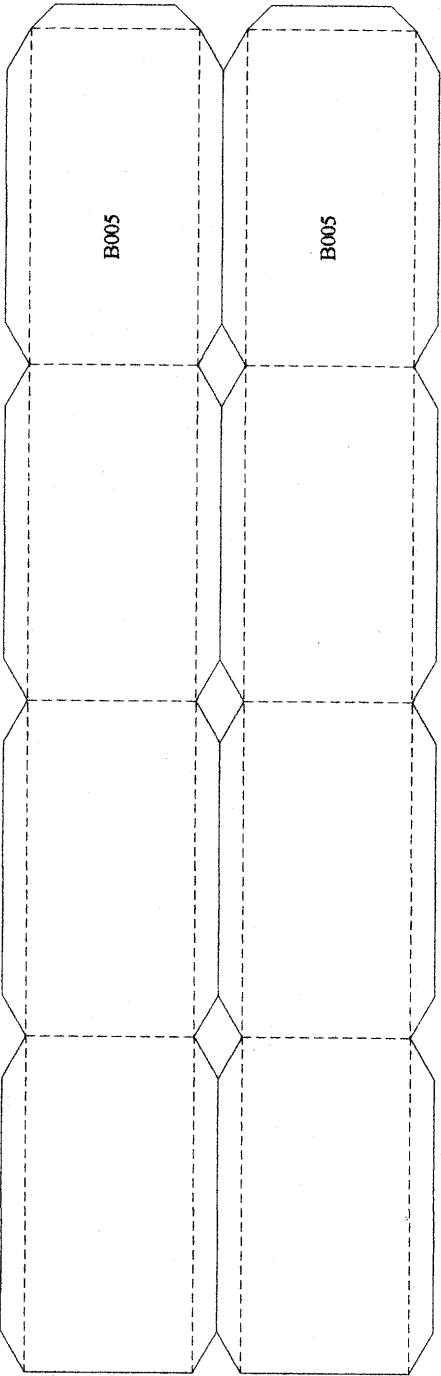
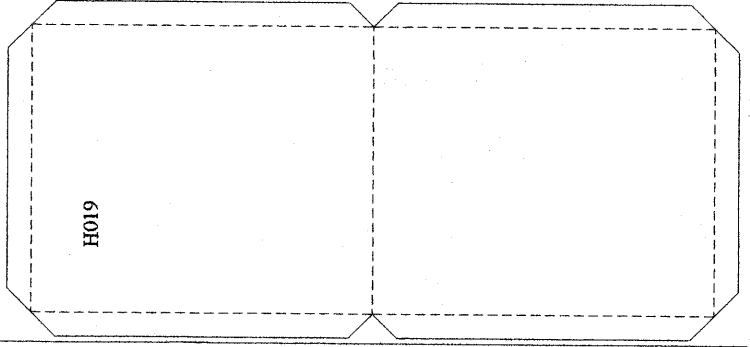
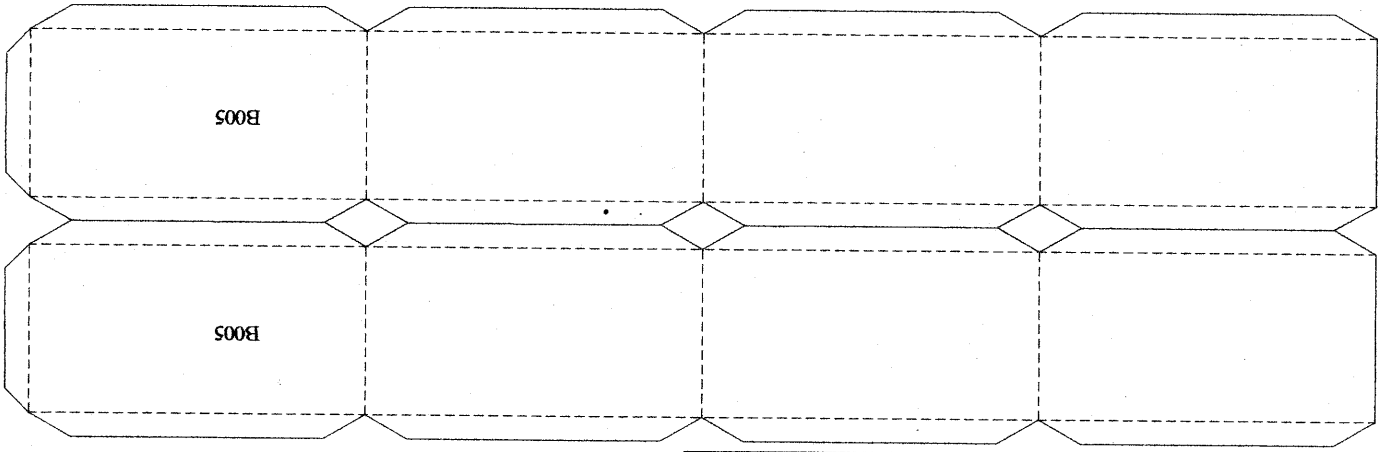



B008

B007

H022

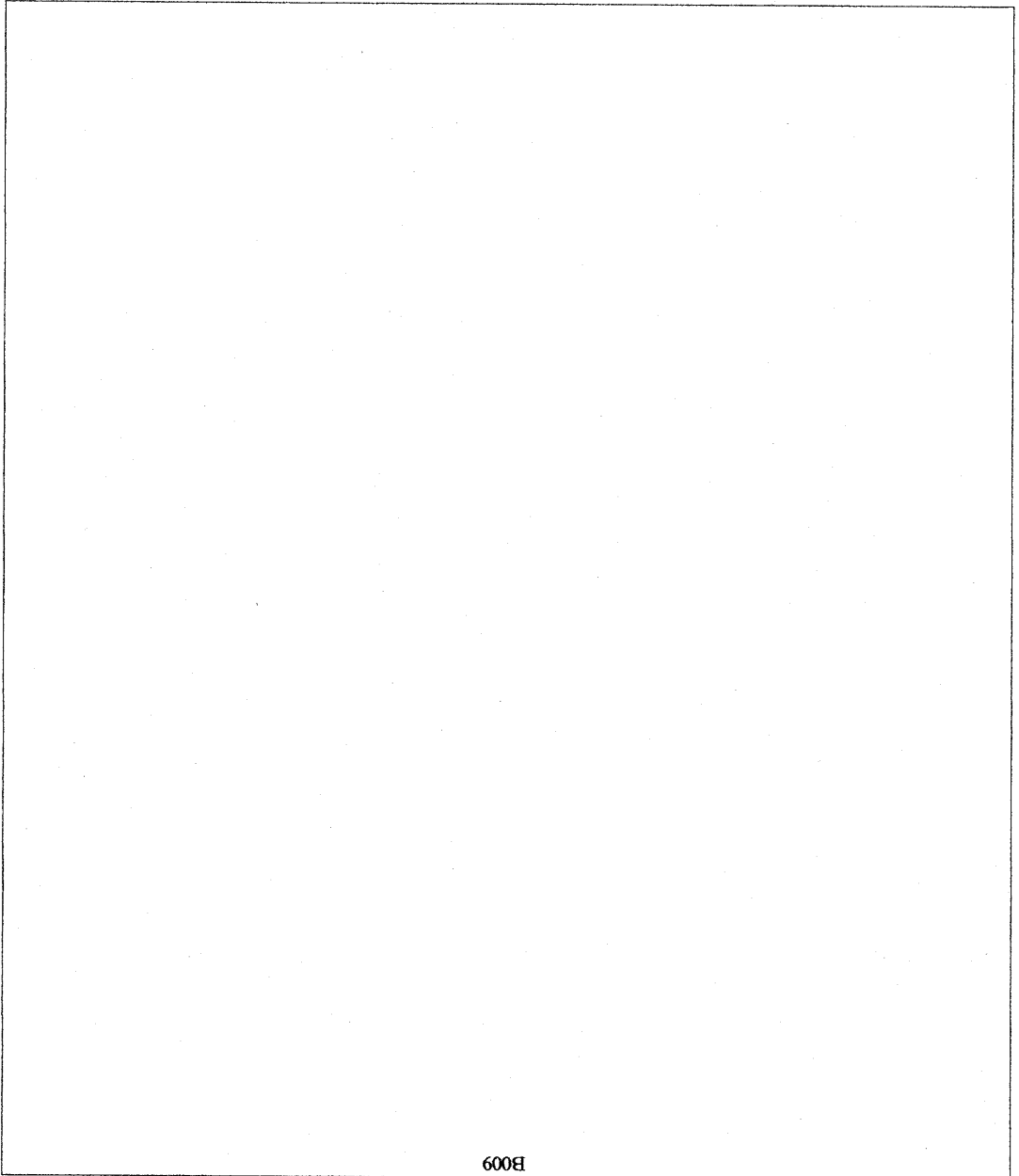

B009

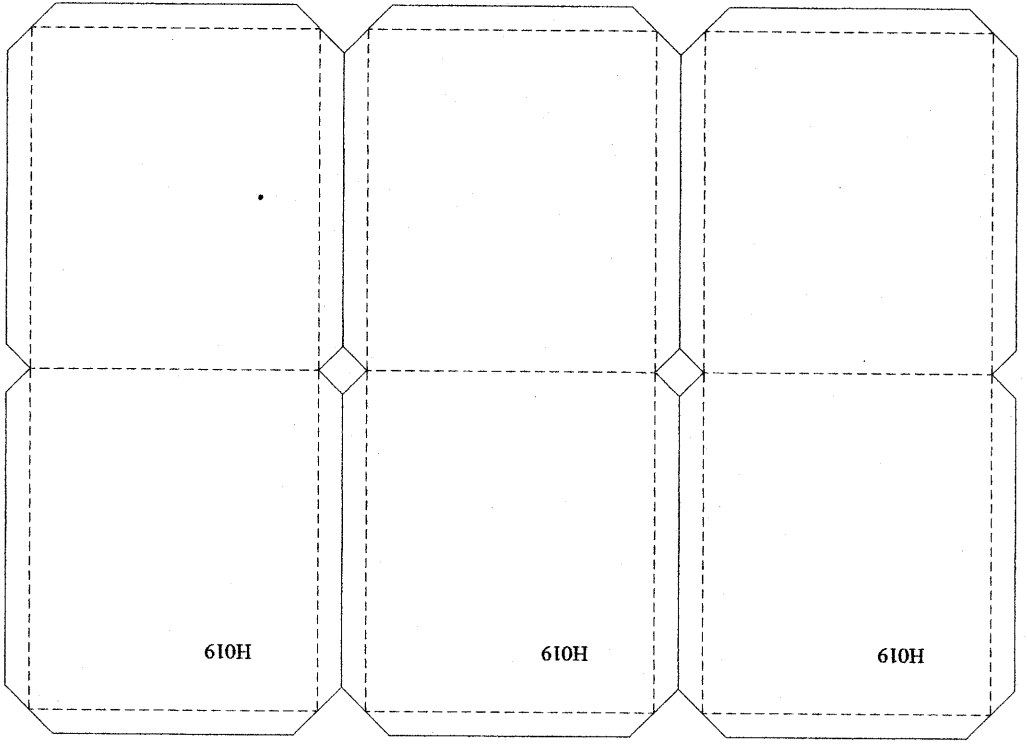

H019

H019

H019

H022

B008

B007

H022

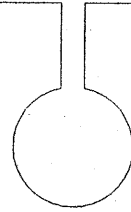

H017

B011

B010

B007	B008	B007	B008	B007	B008	B007	B008	B007	B008
------	------	------	------	------	------	------	------	------	------

B007

H019

H012

B008

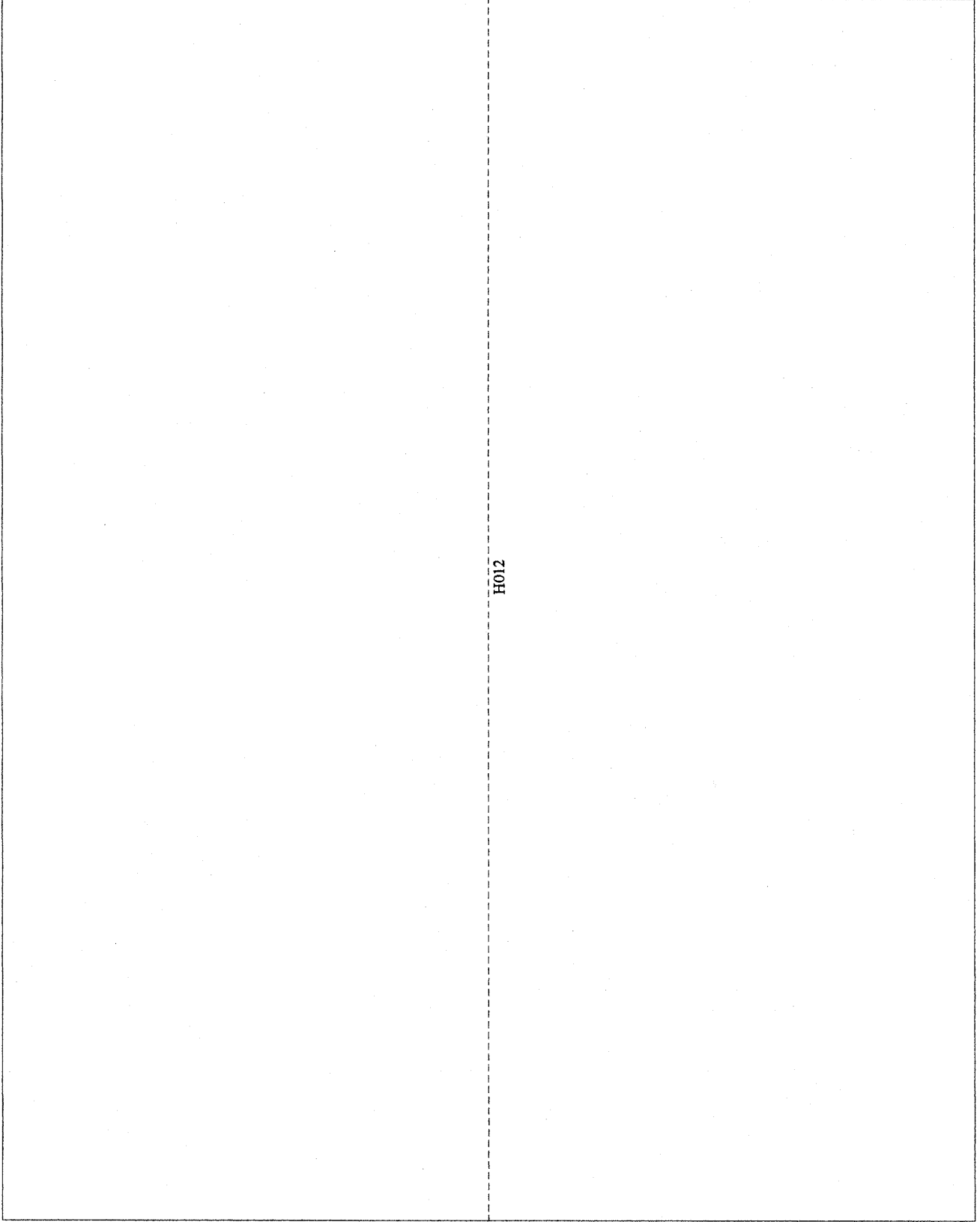
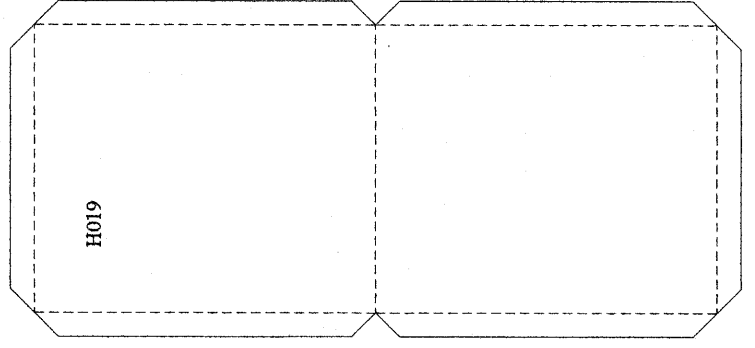

	H022
	H022
	H022

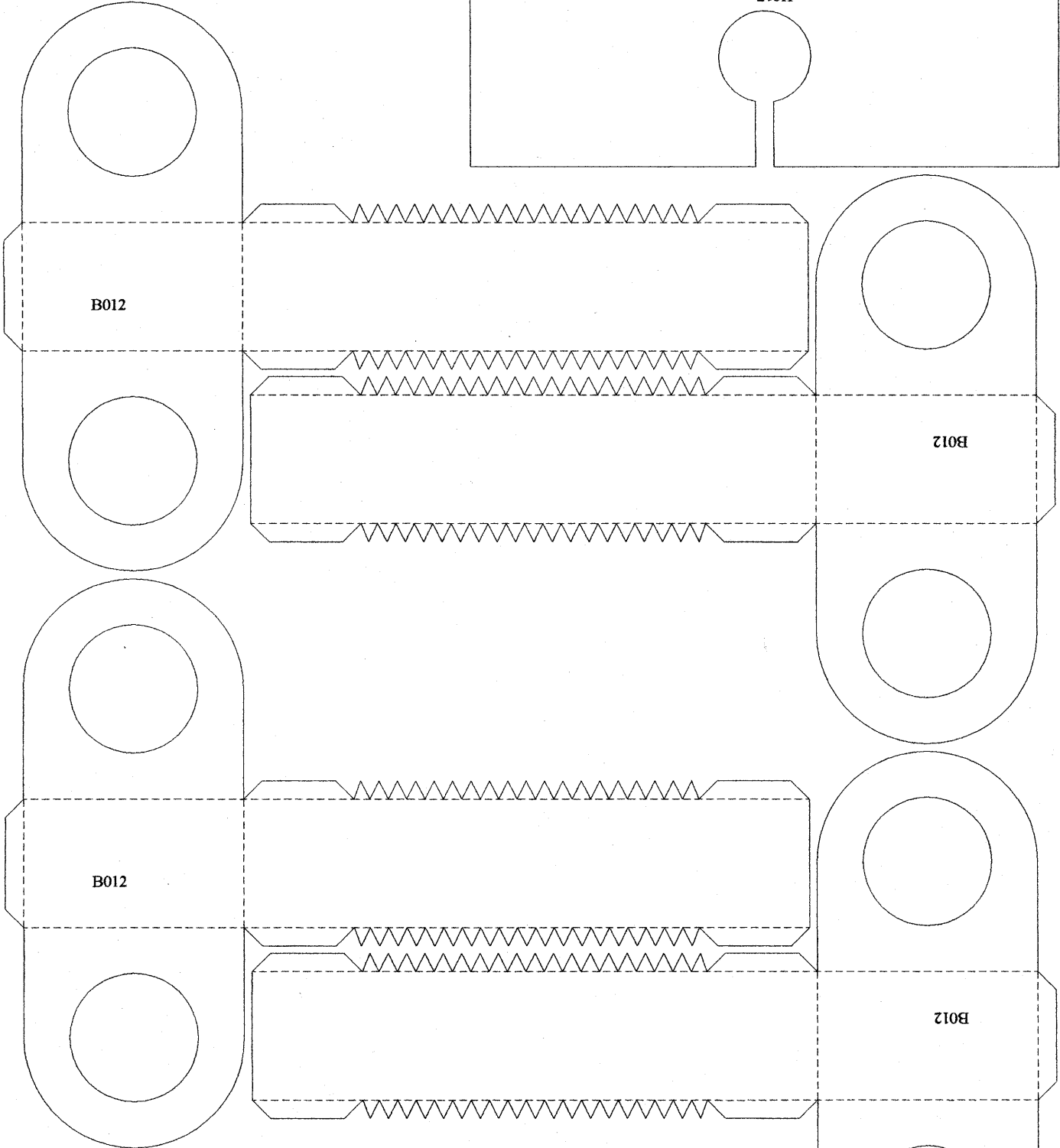
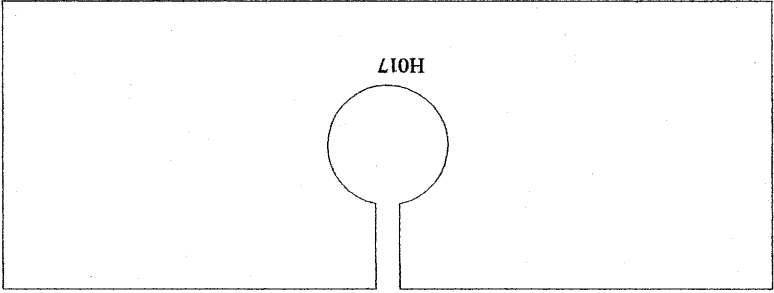

R012	R012	R012	R012	R012	R012	R012	R012
R012	R012	R012	R012	R012	R012	R012	R012
R012	R012	R012	R012	R012	R012	R012	R012

H022

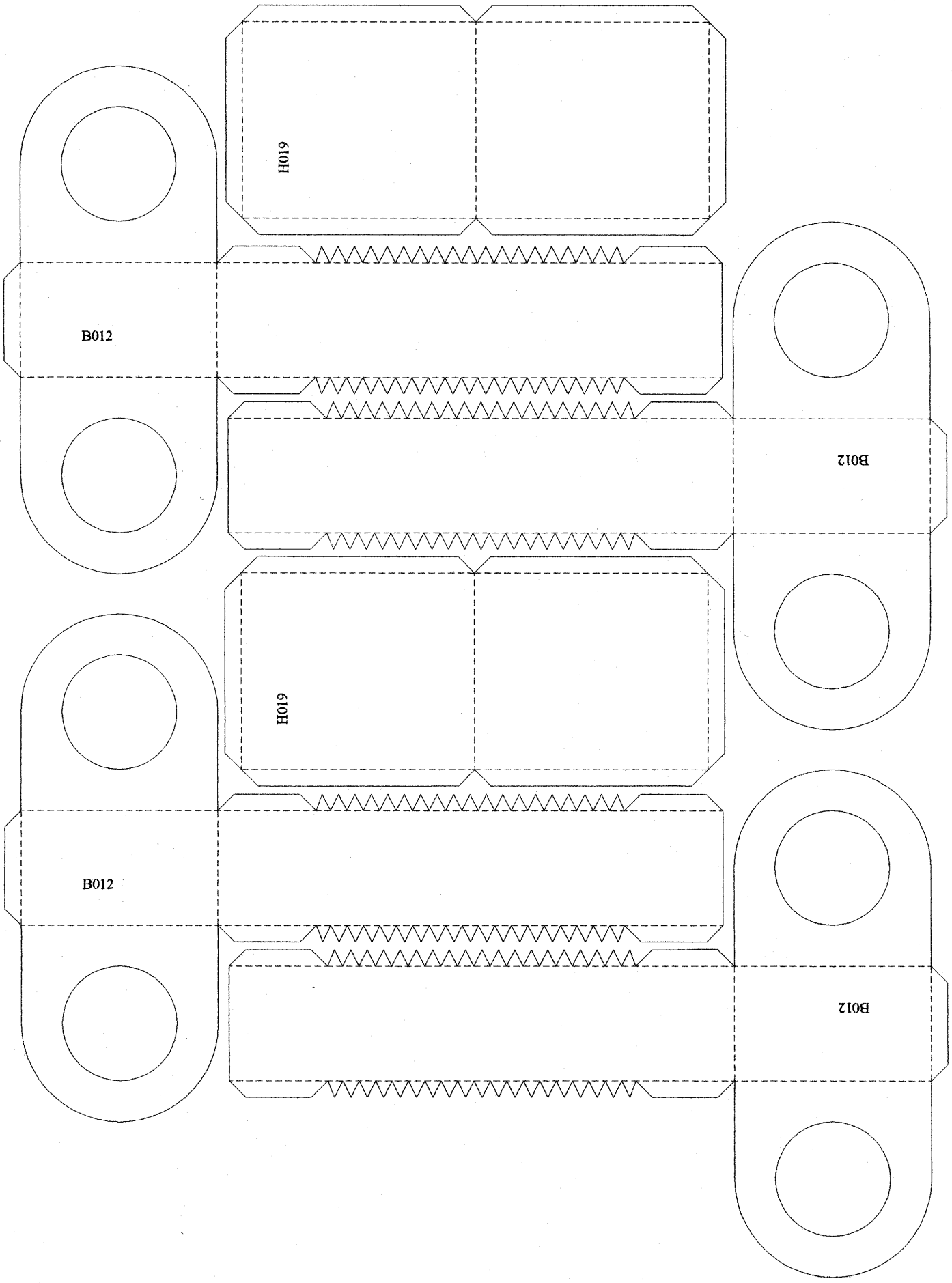

H019

H019

H013

H013



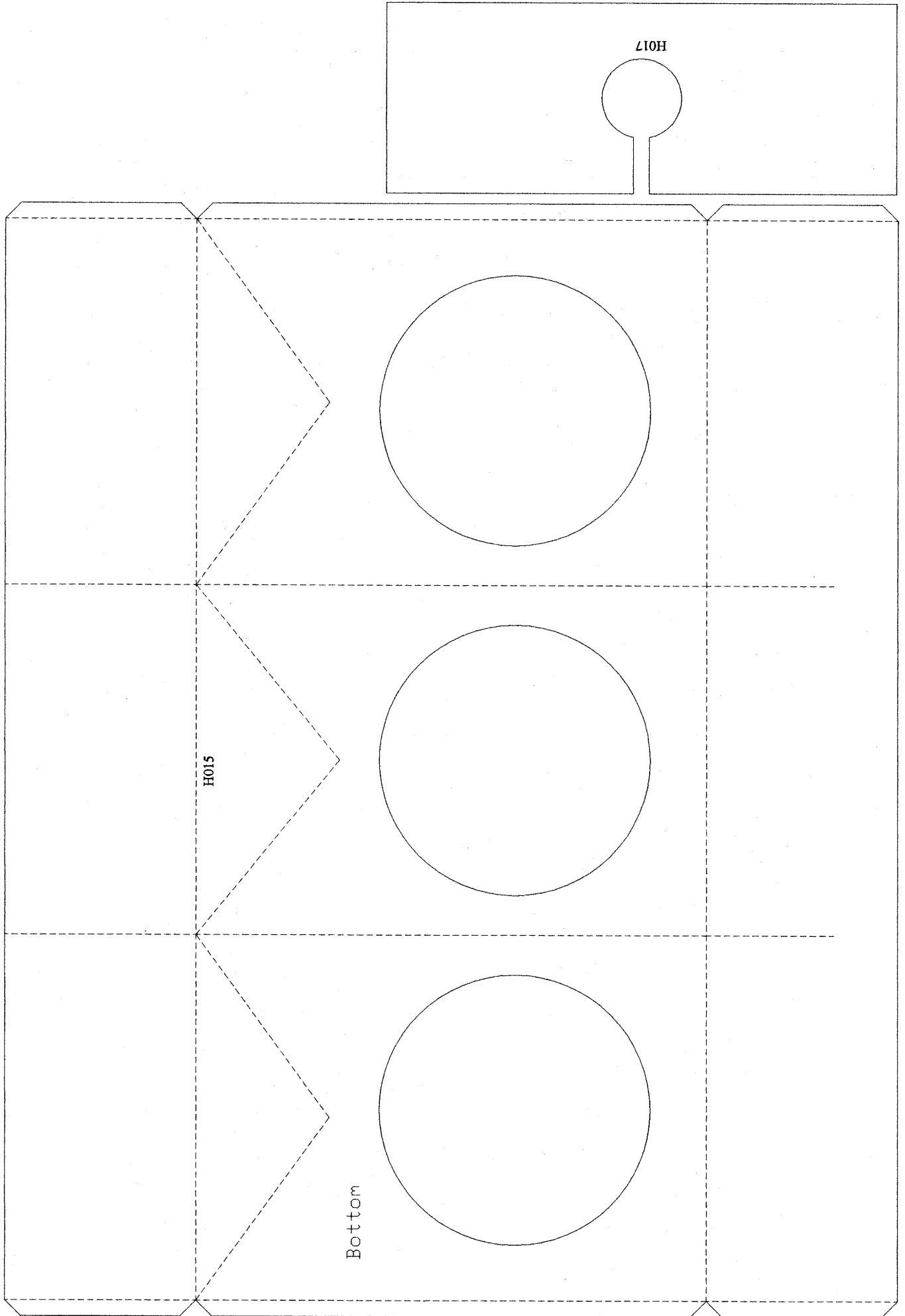

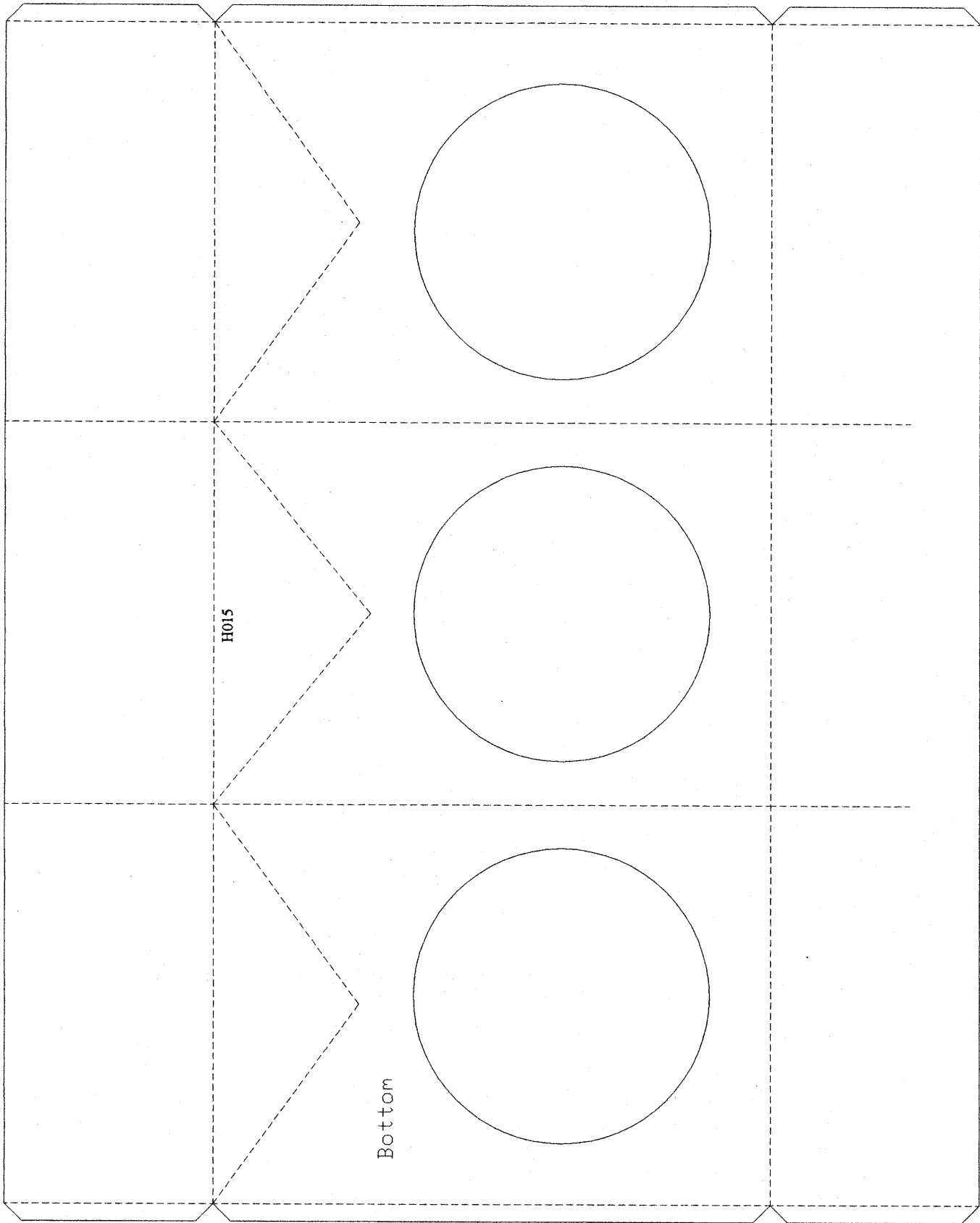
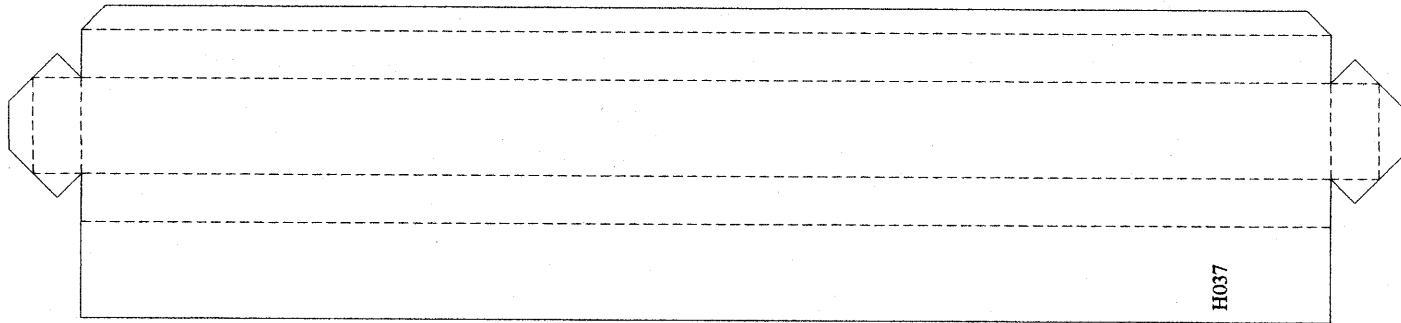

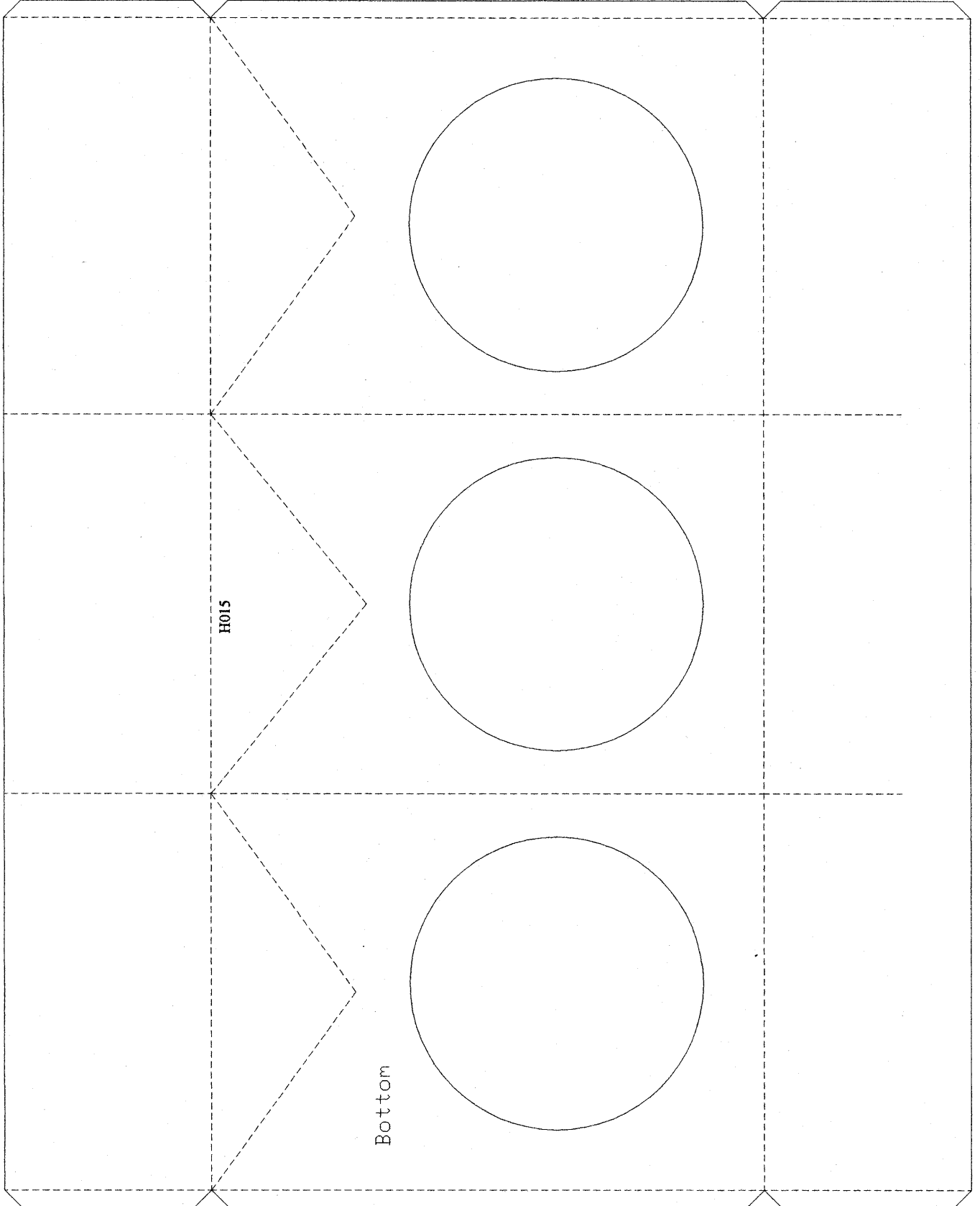
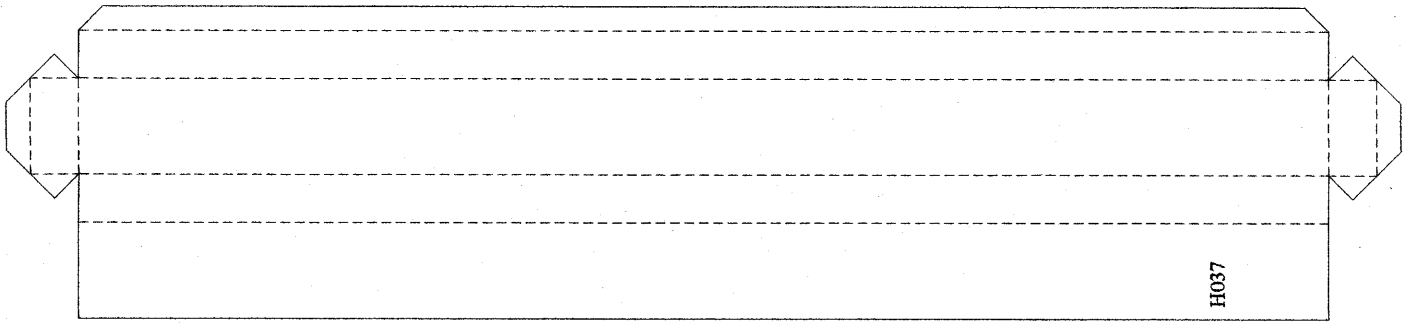

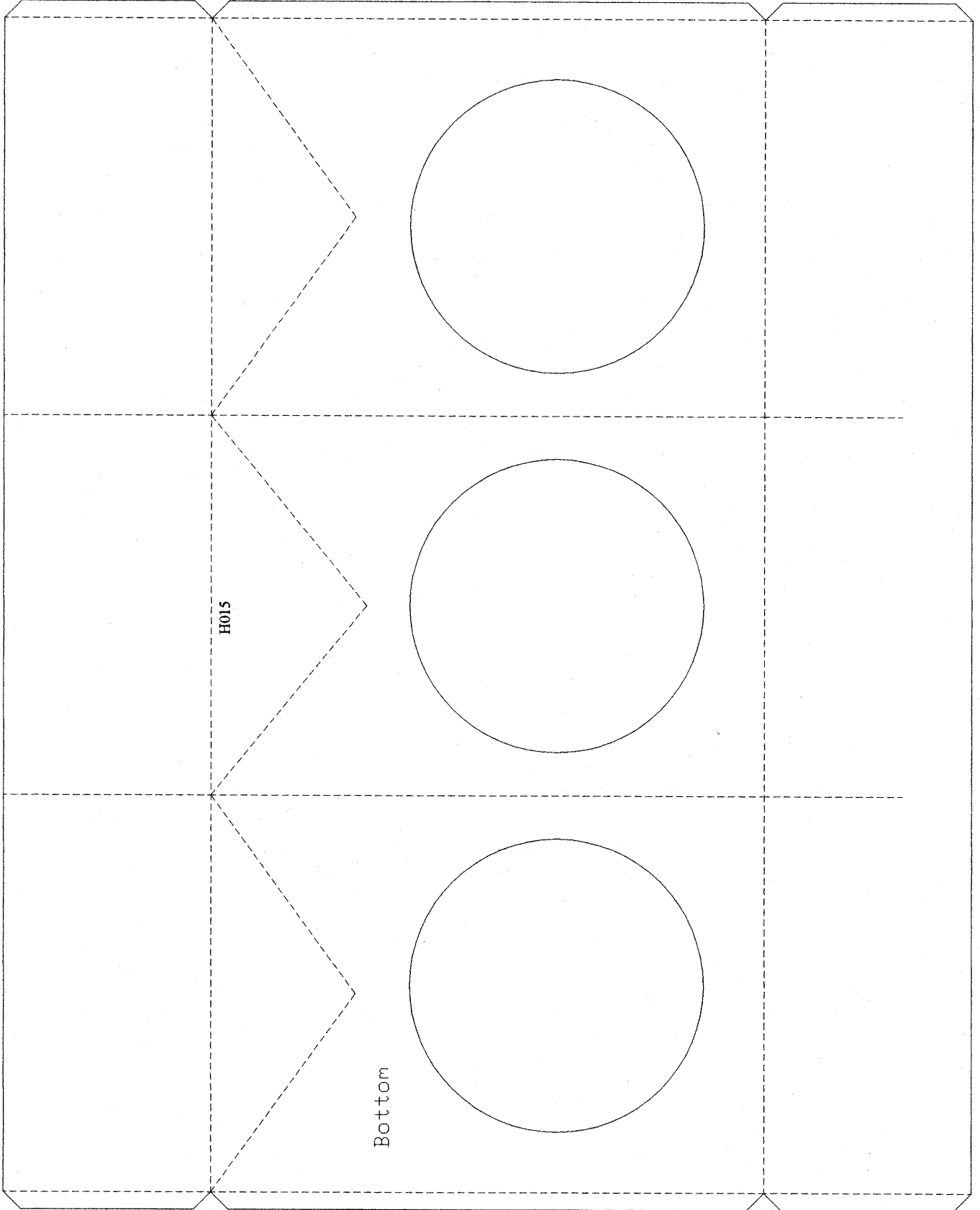
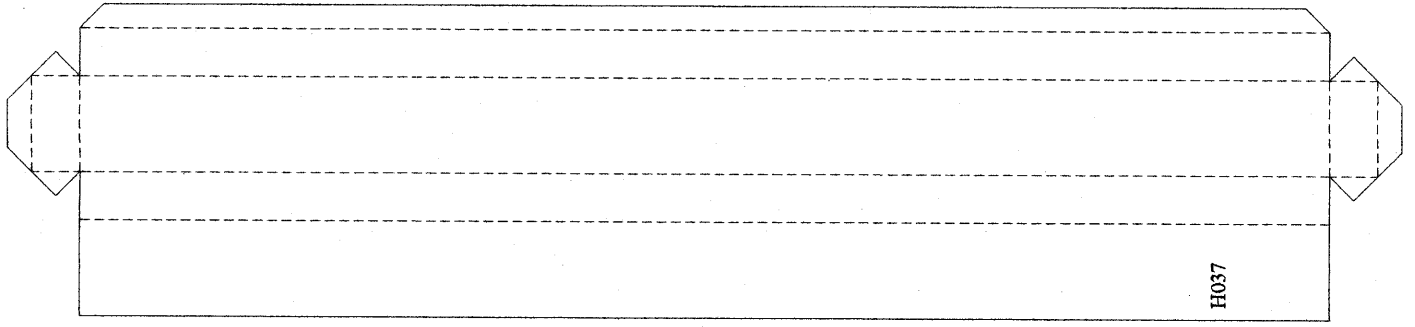

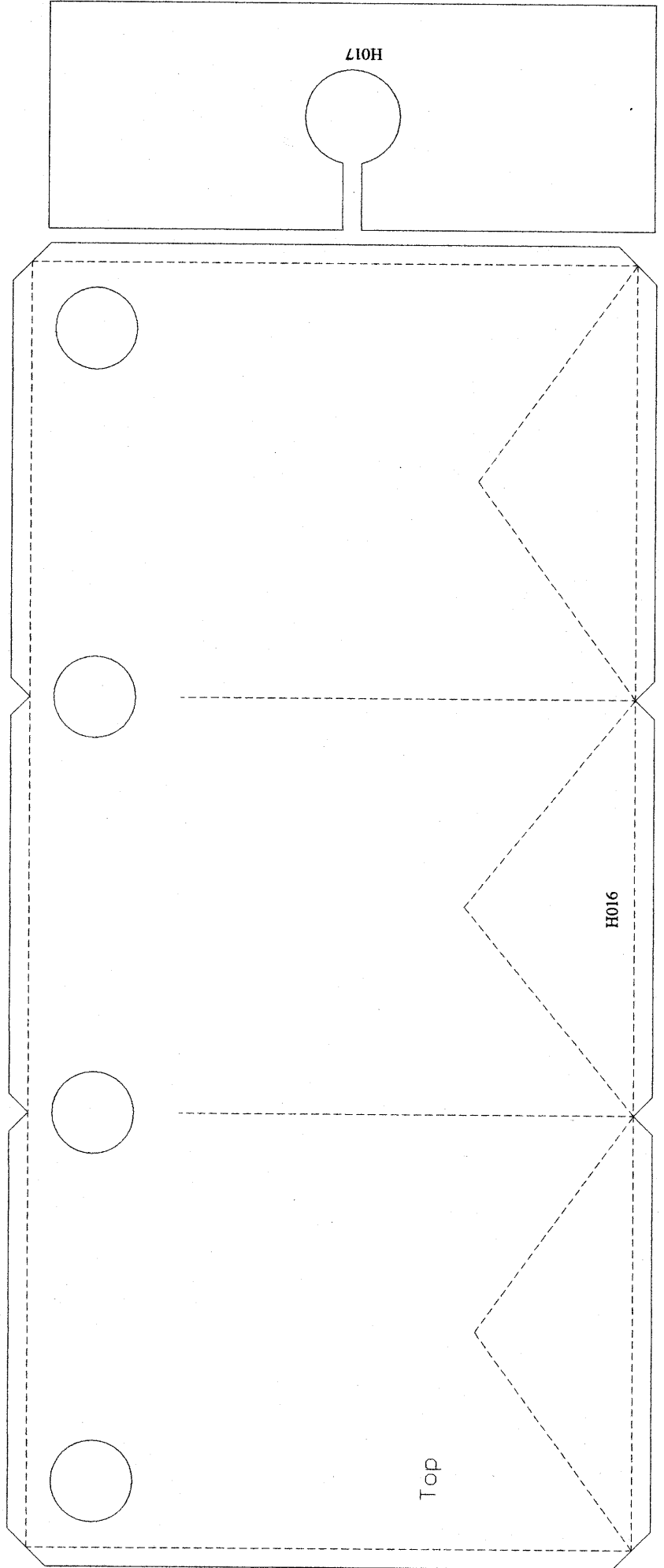
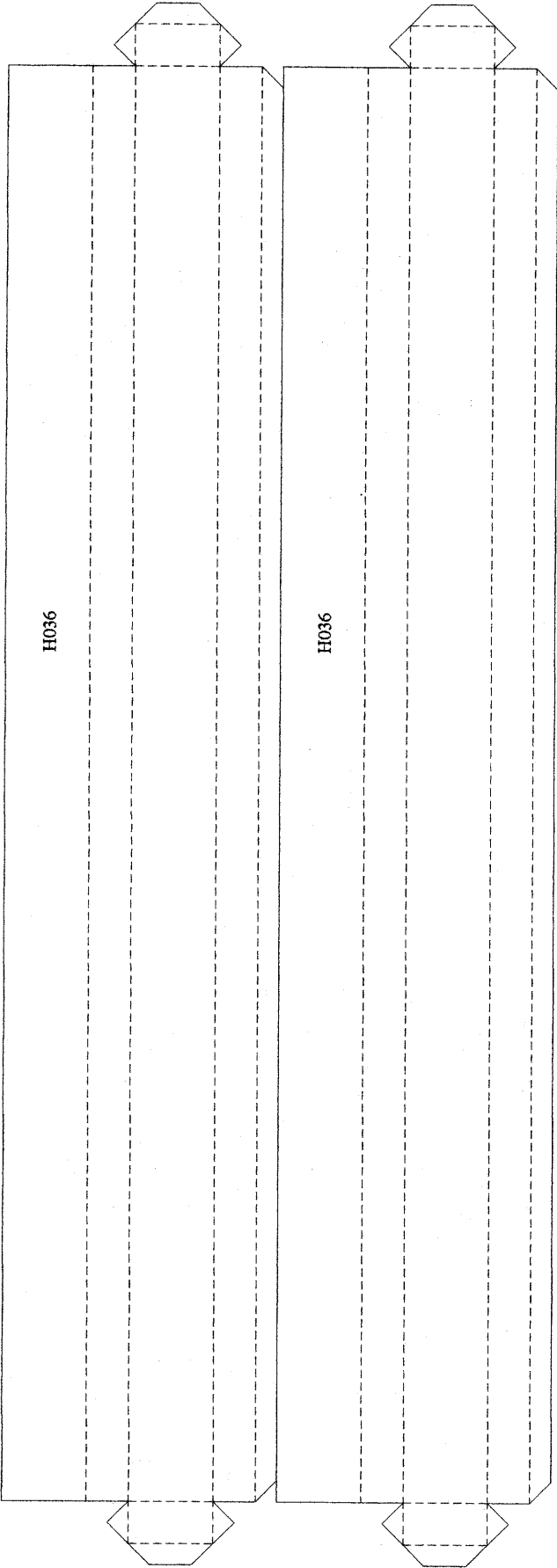

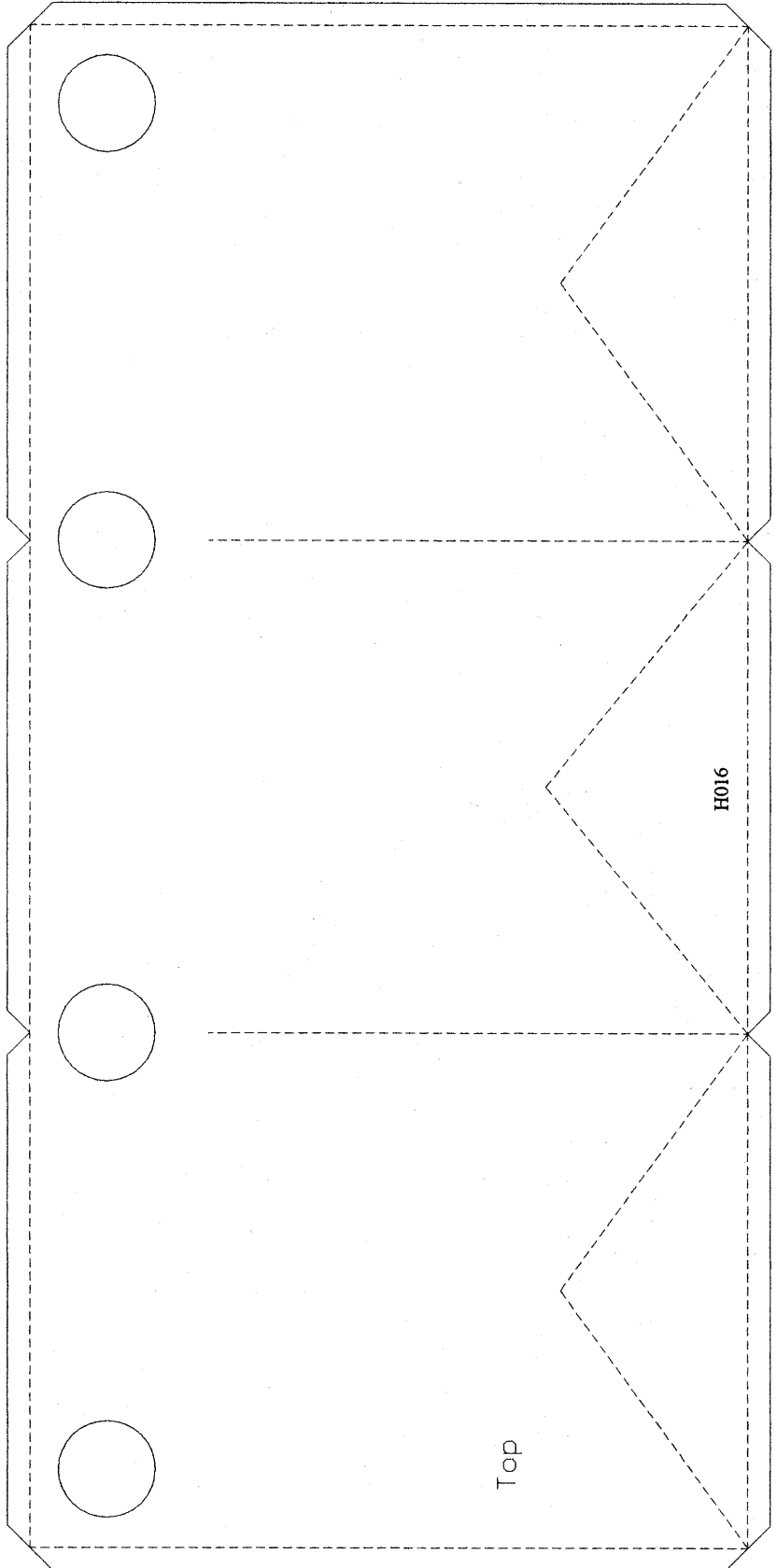
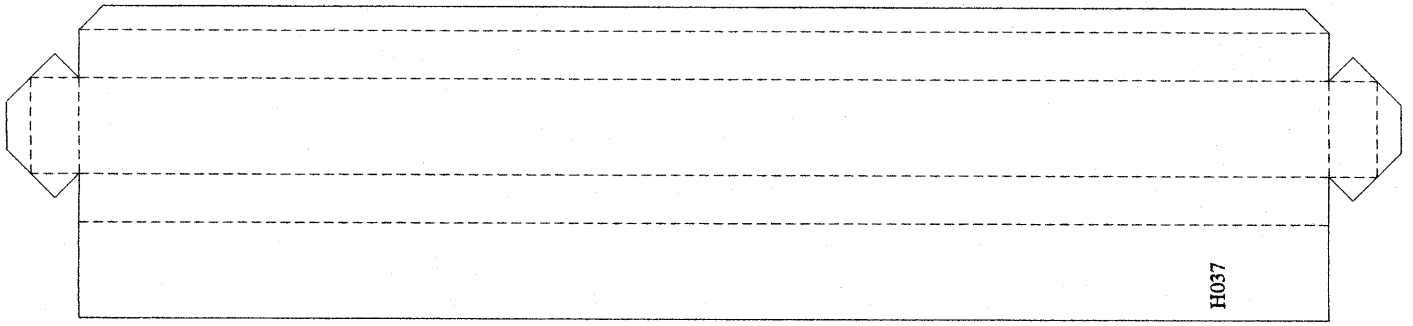
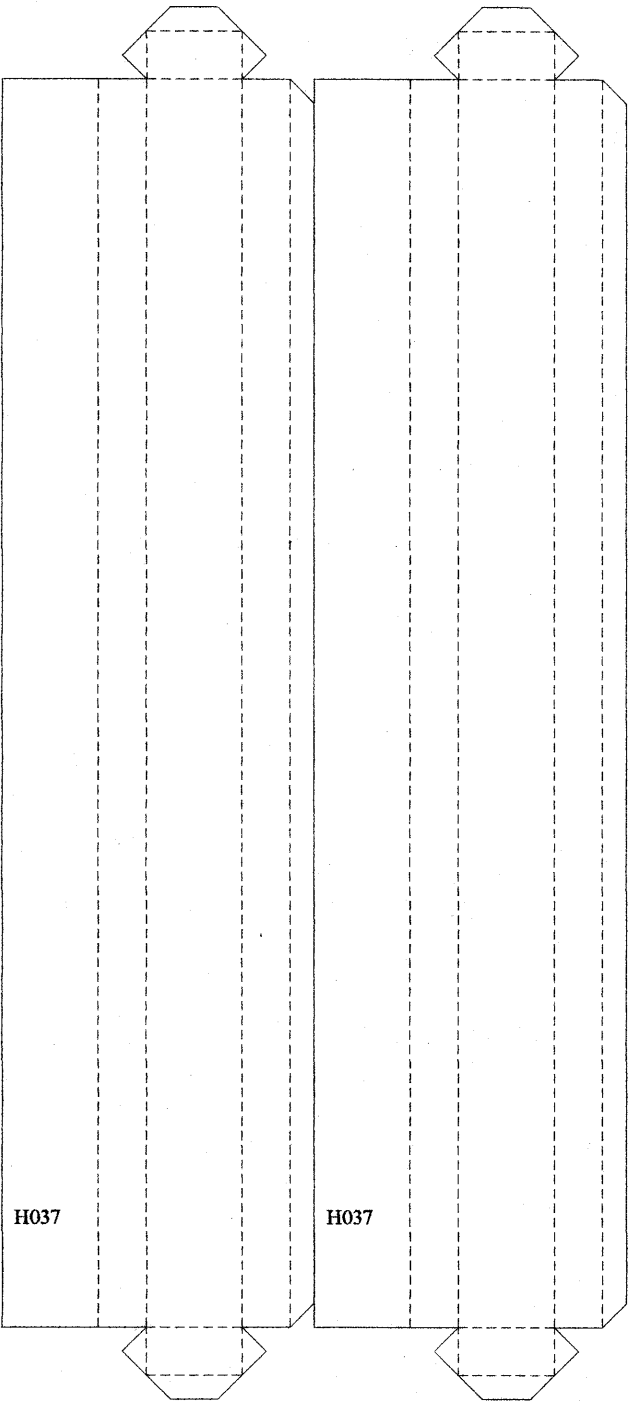

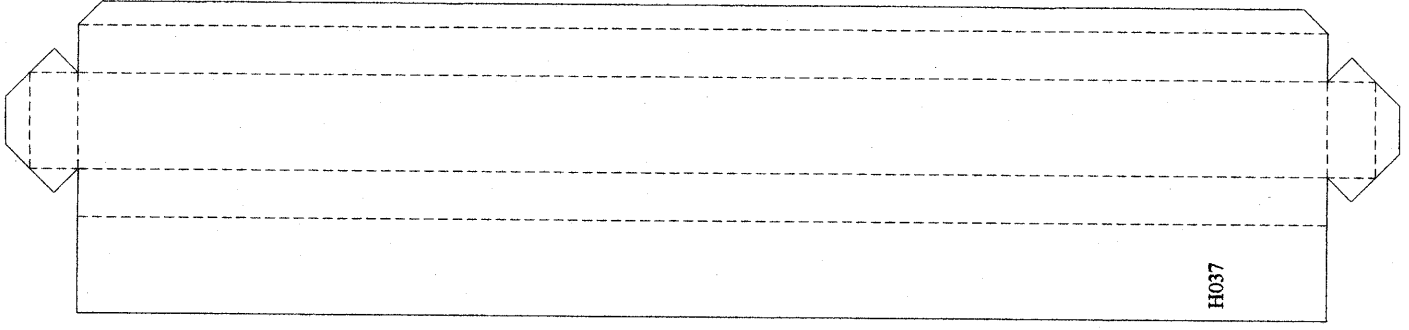
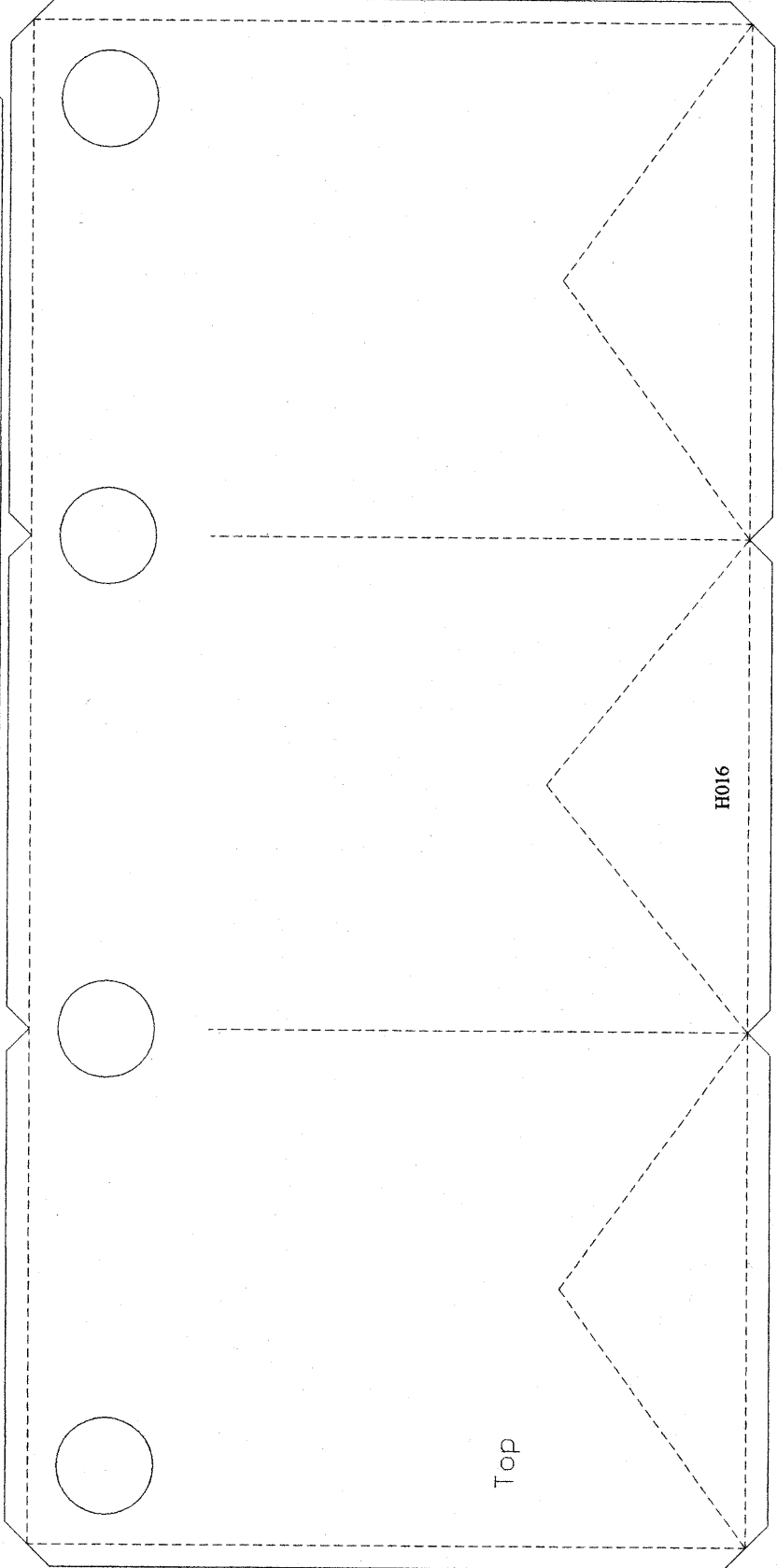
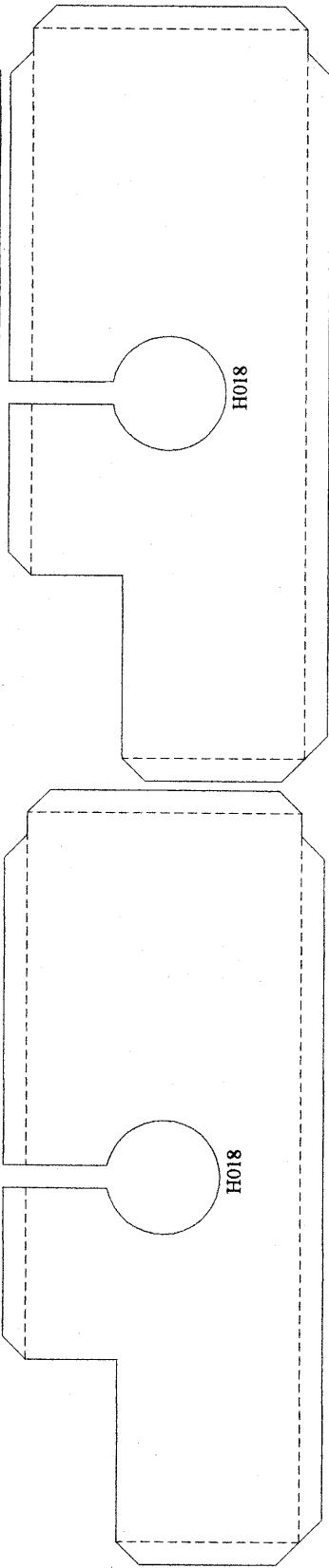
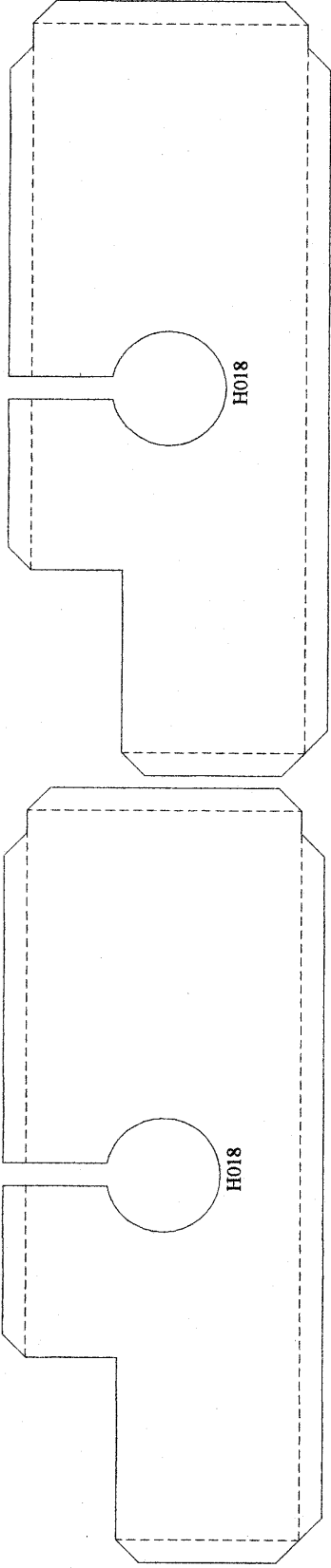

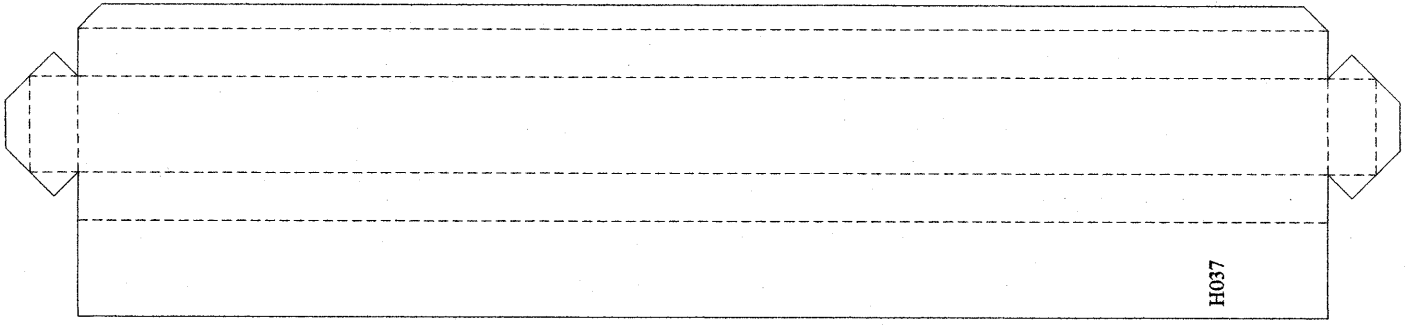
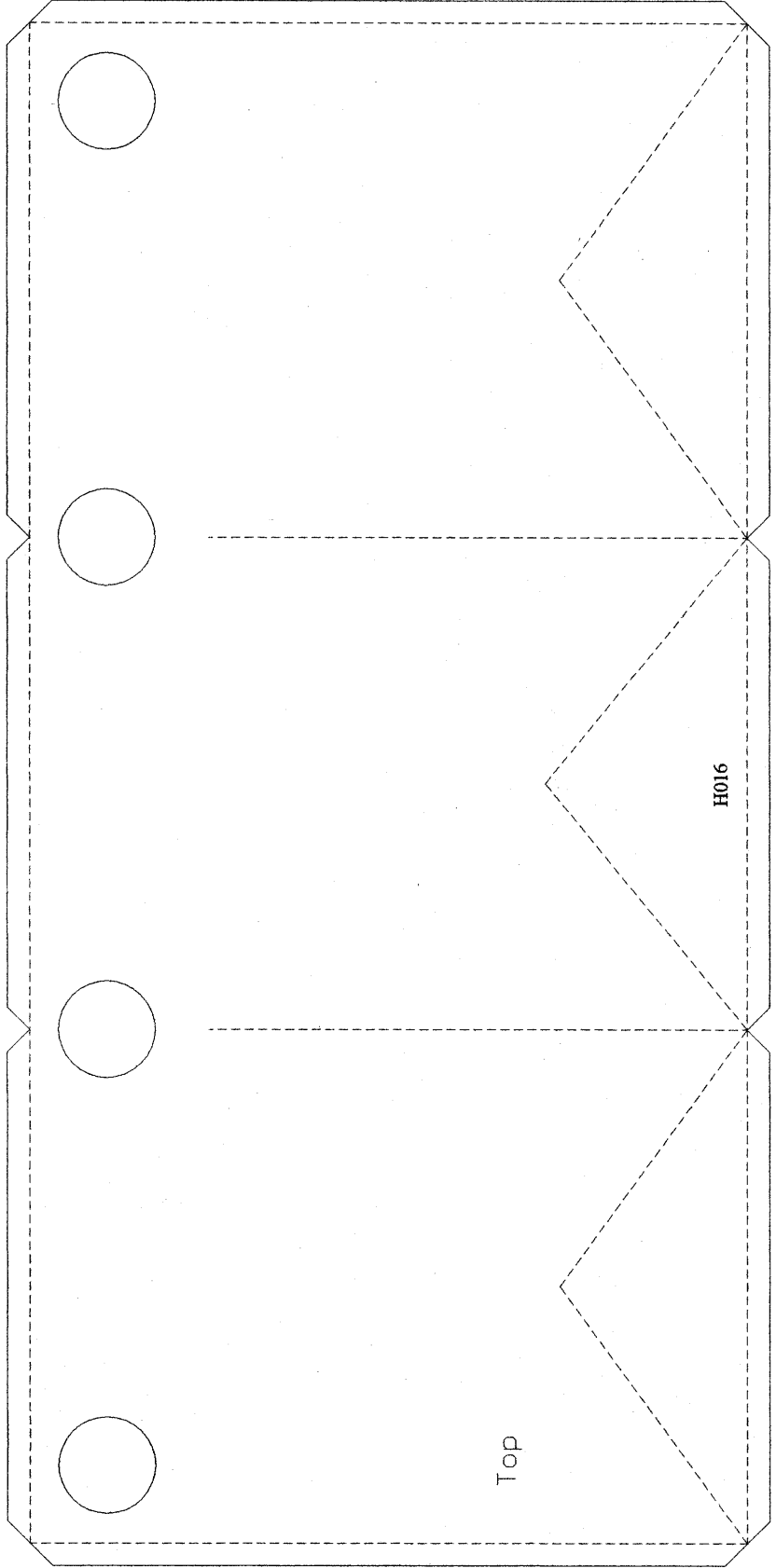
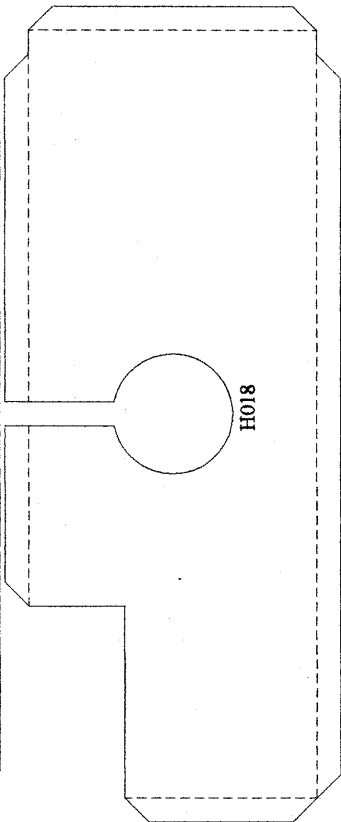
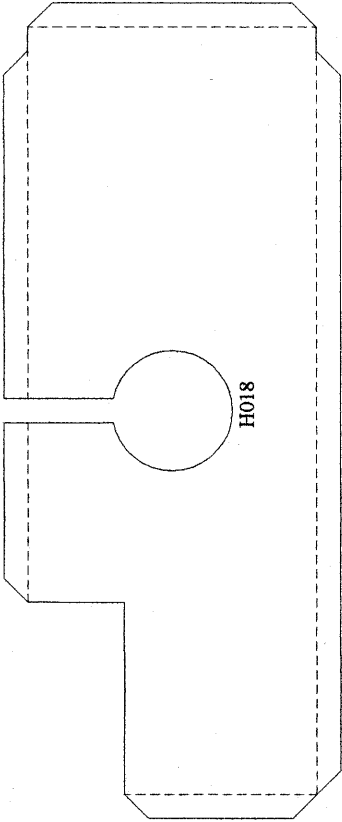
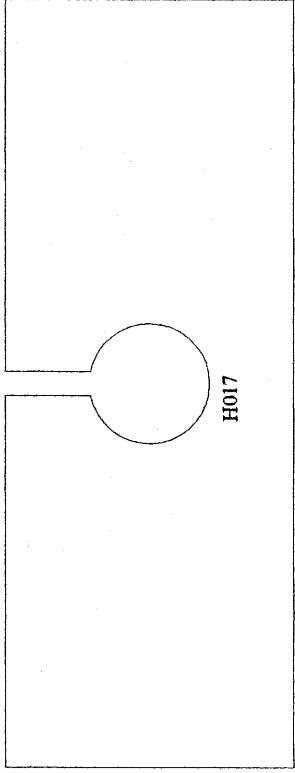
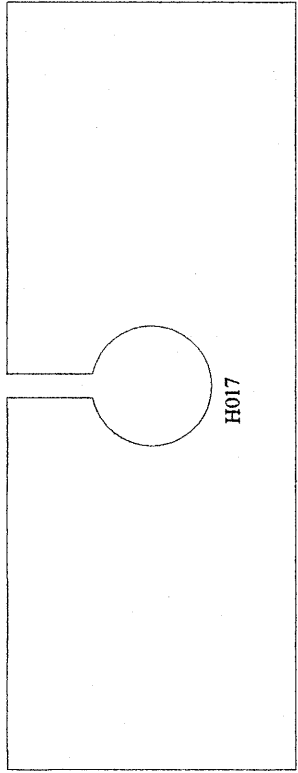



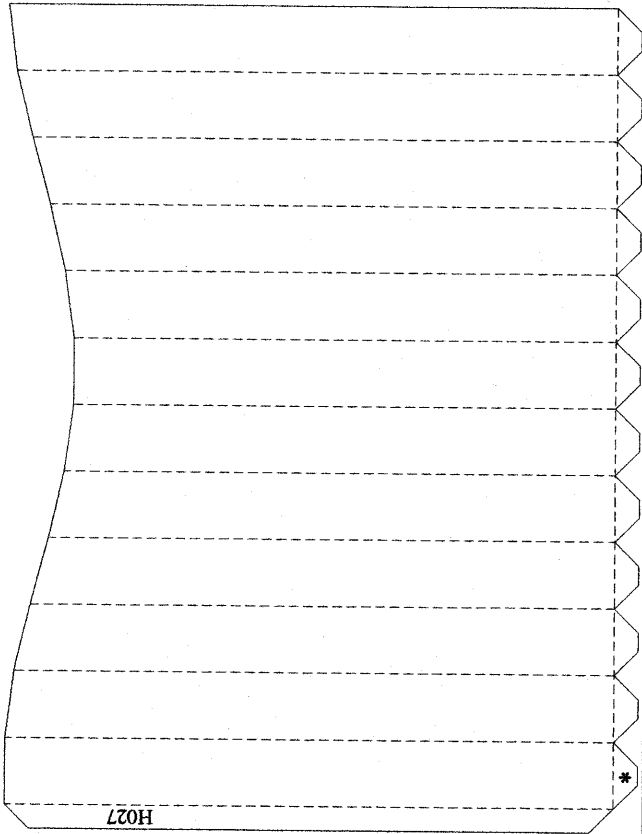
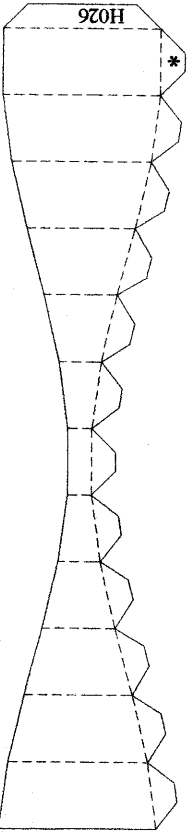
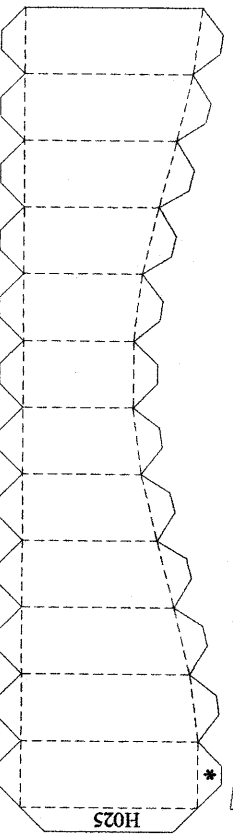
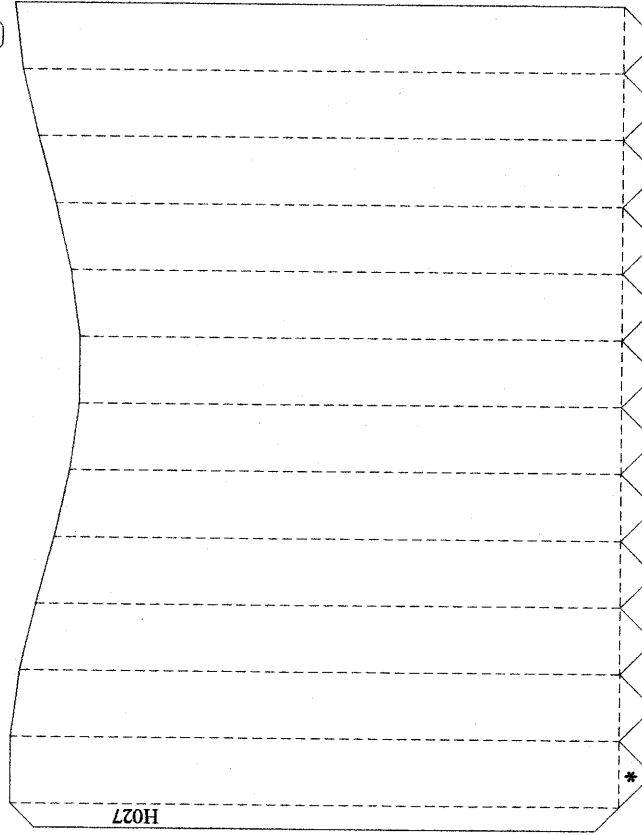
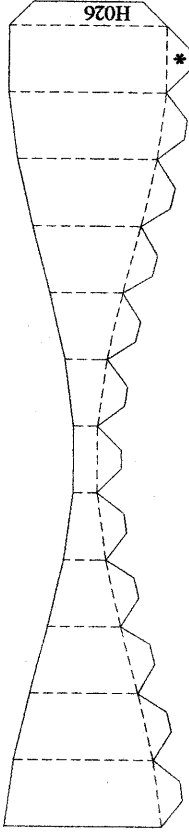
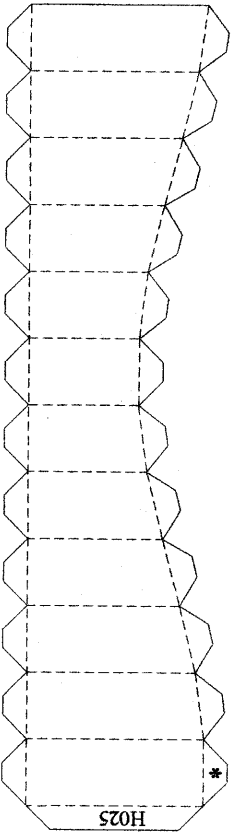
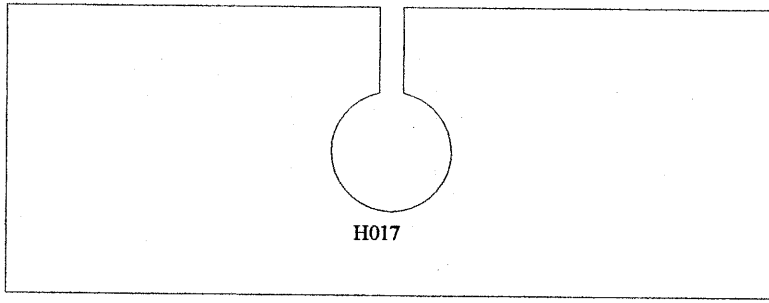

H028
H029
H029
H028
H029
H029

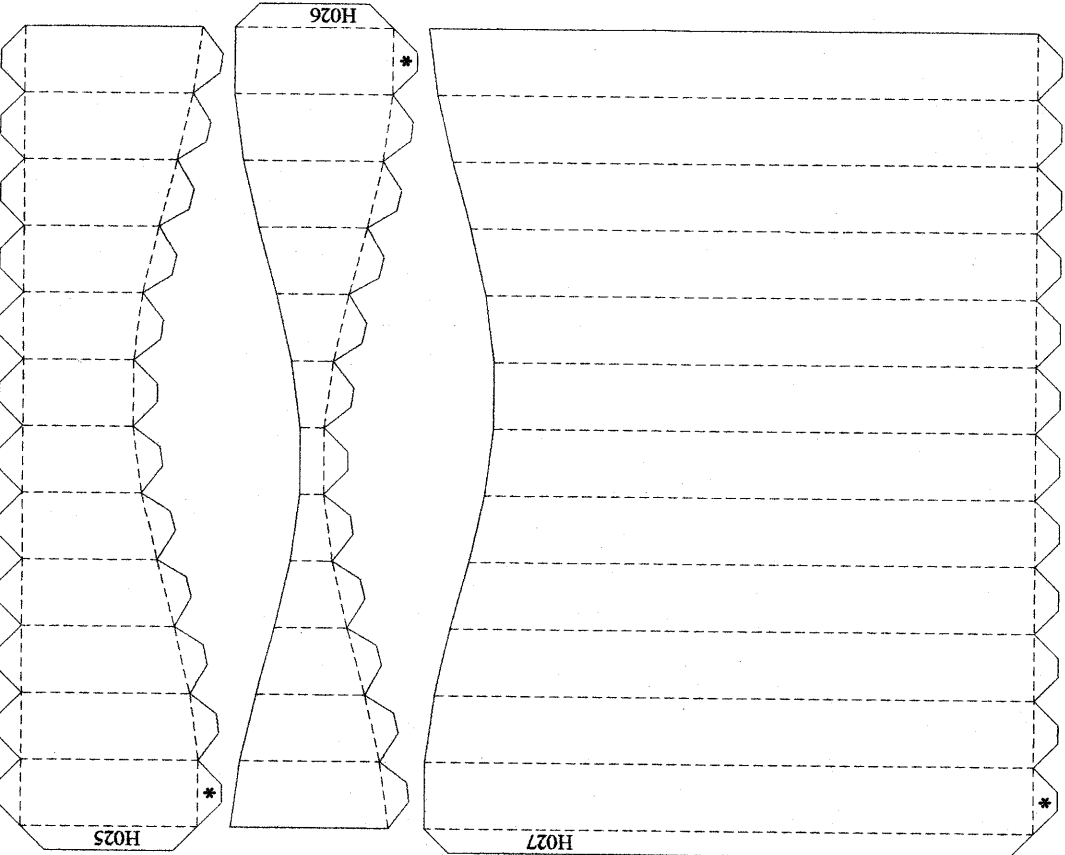
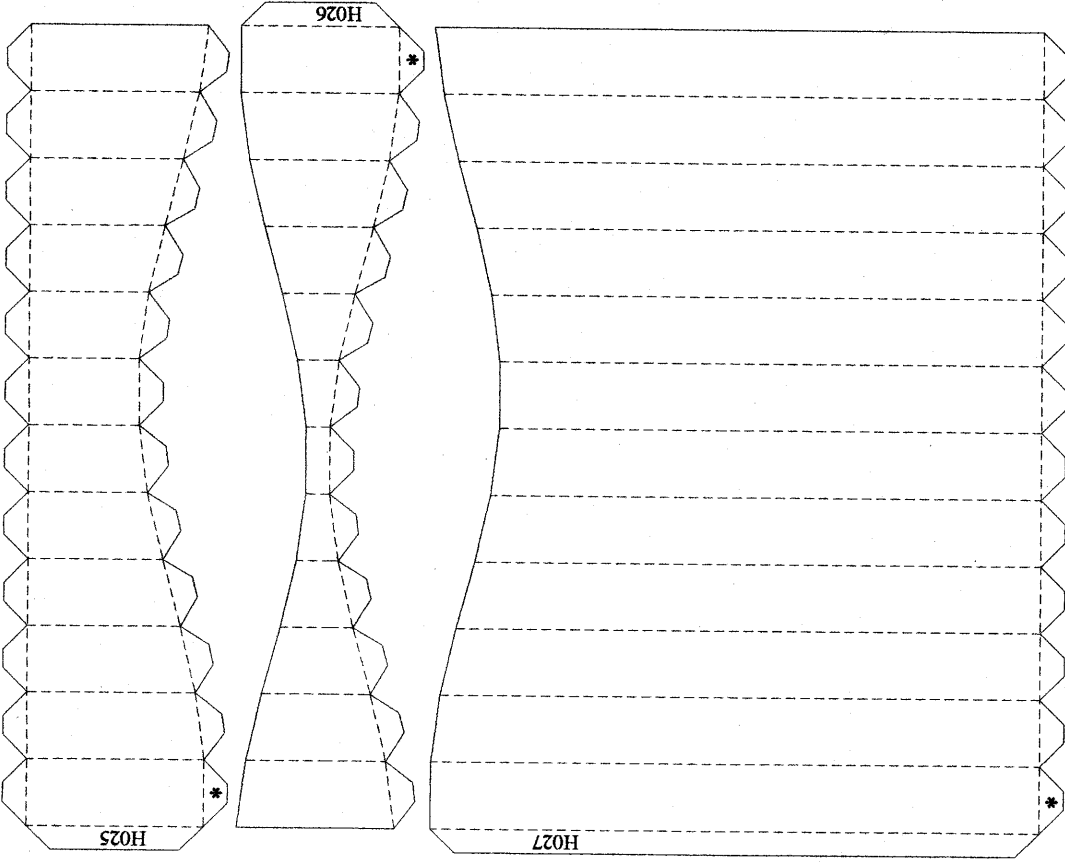

H028	
H029	
H029	
H028	
H029	
H029	

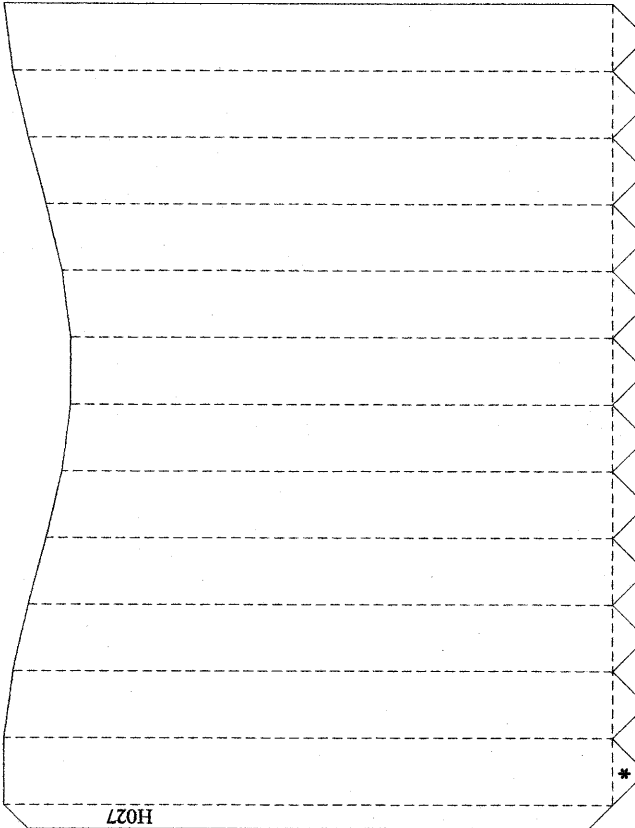
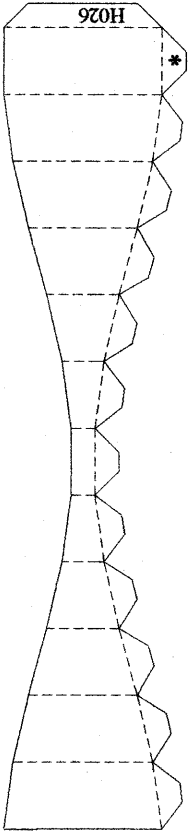
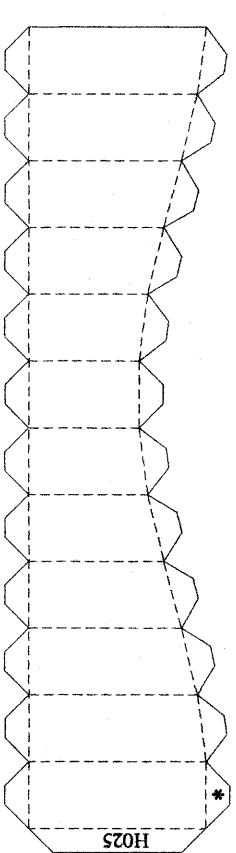
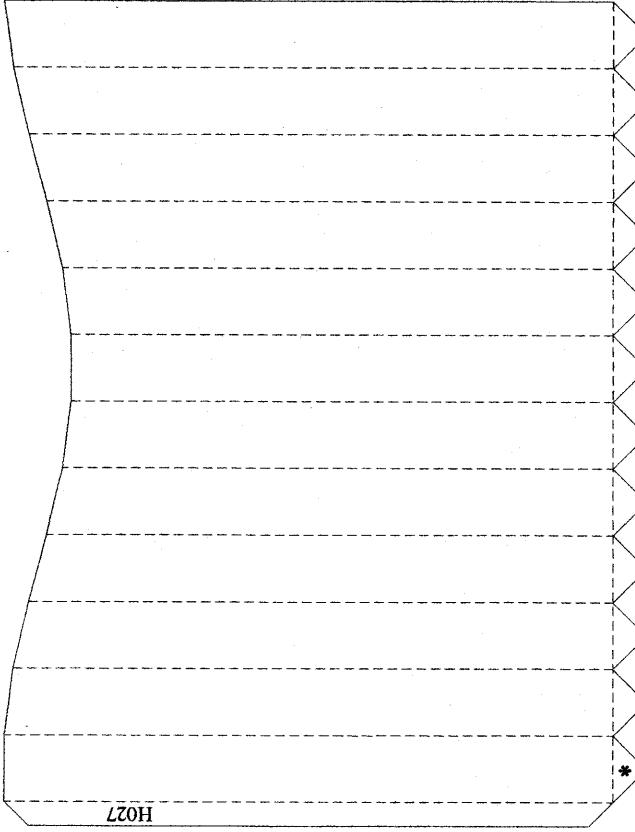
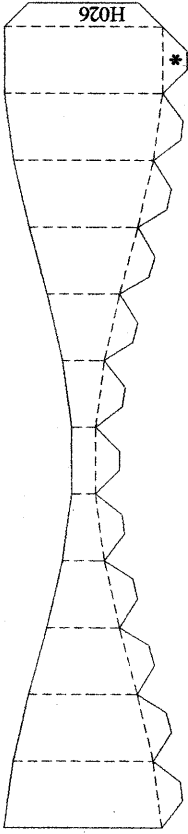
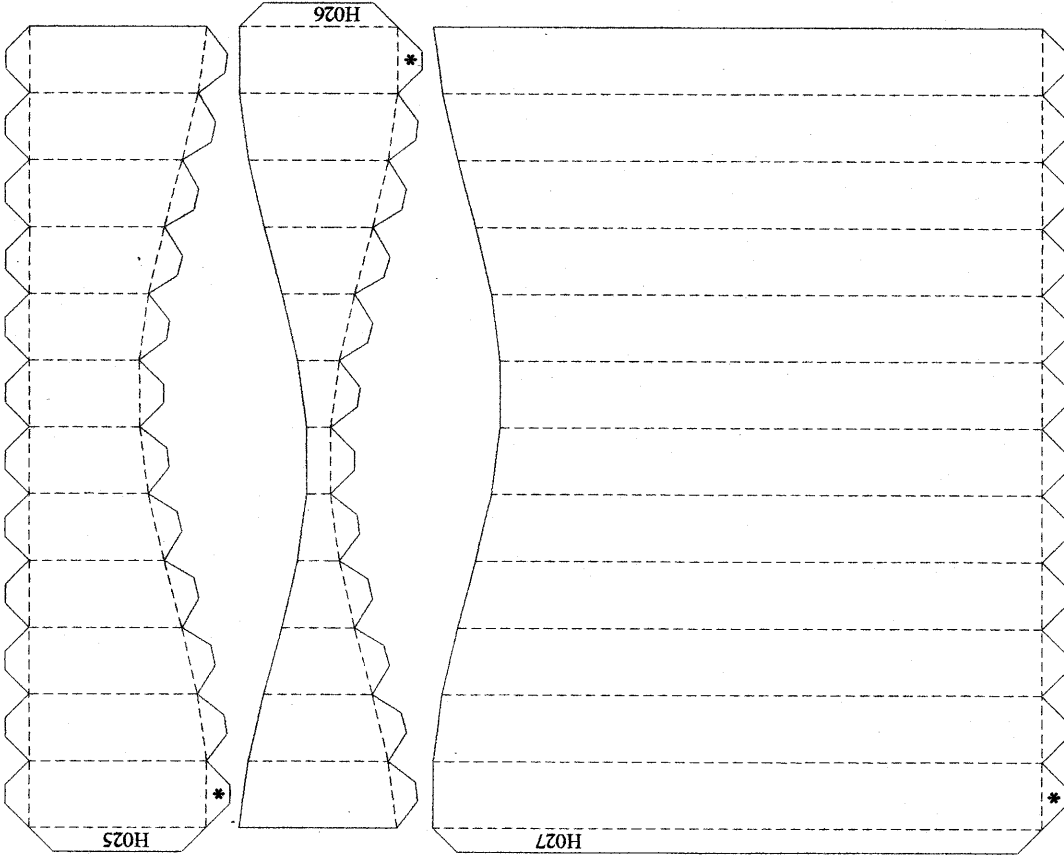

H028	
H029	
H029	
H028	
H029	
H029	

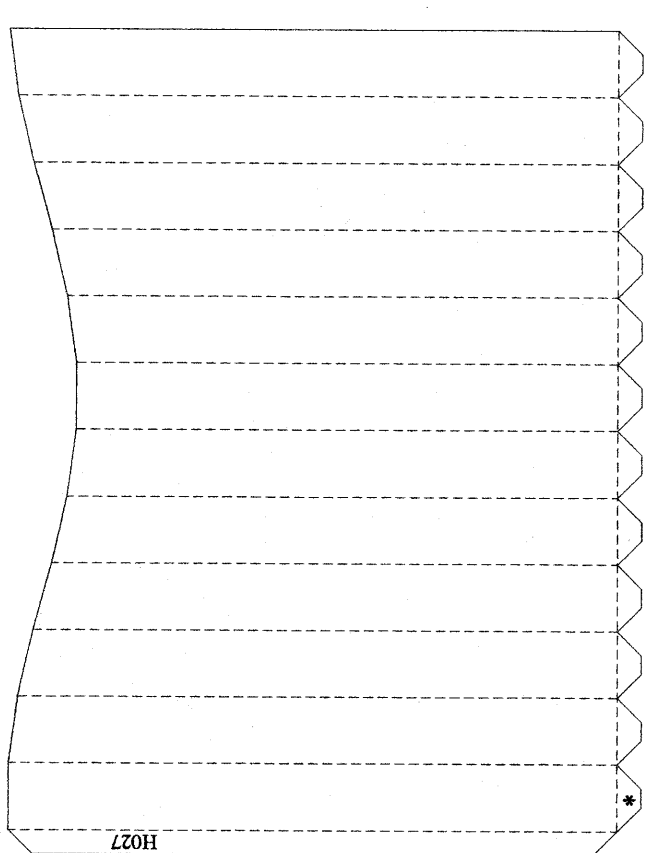
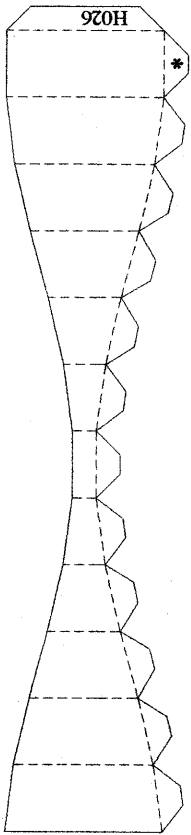
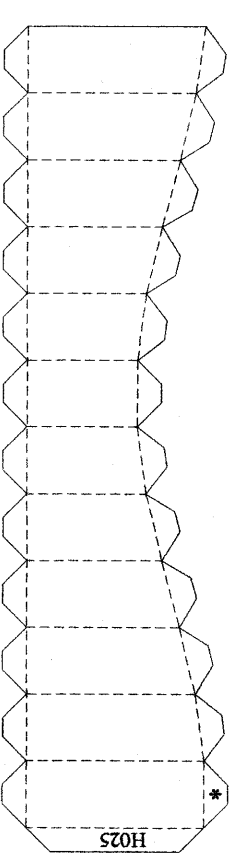
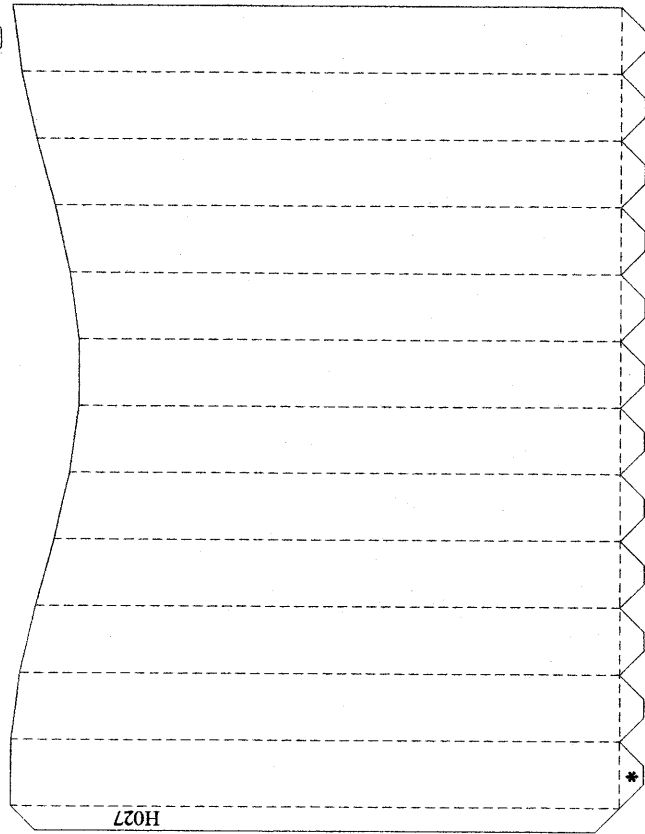
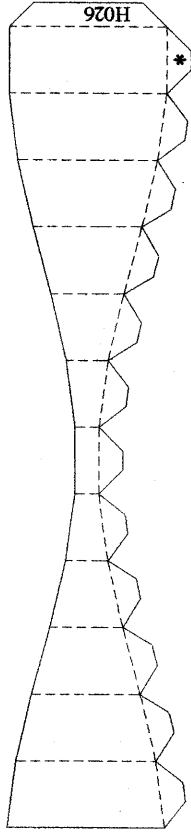
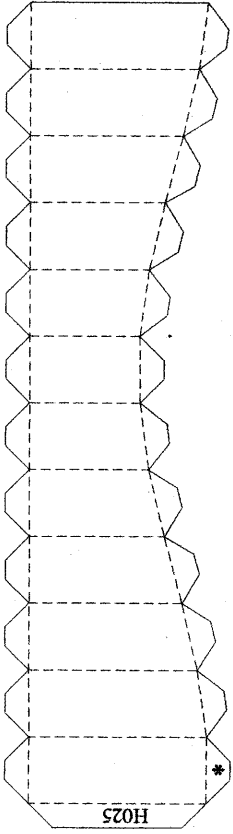

H028	828
H029	
H029	
H028	
H029	
H029	

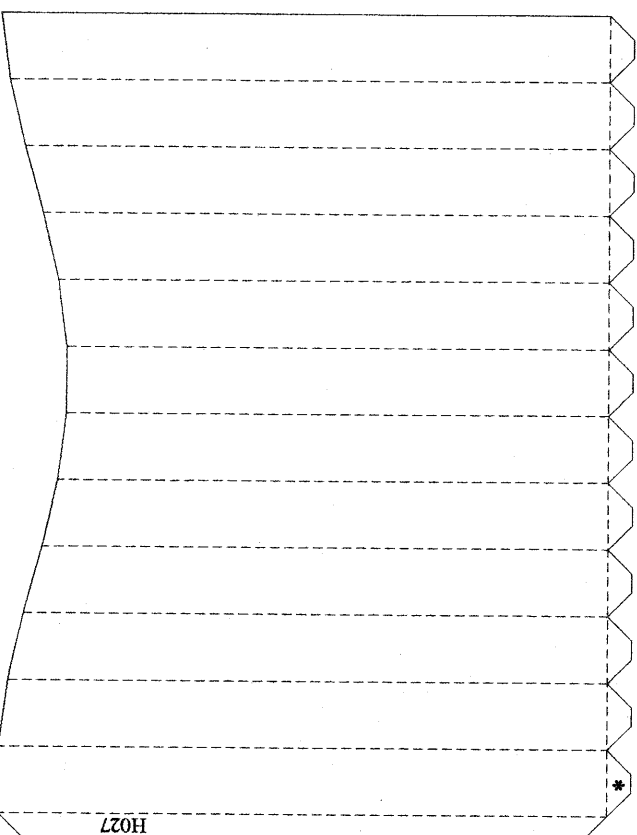
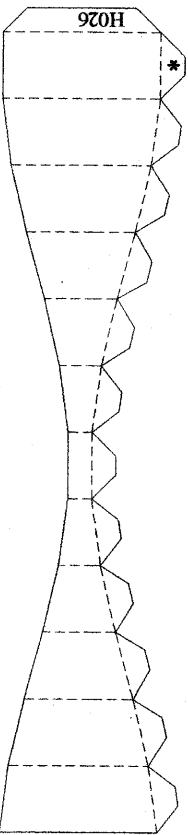
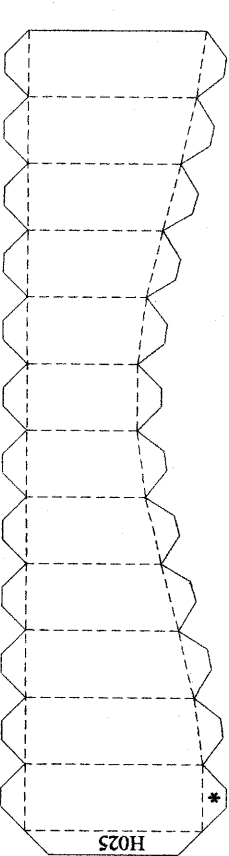
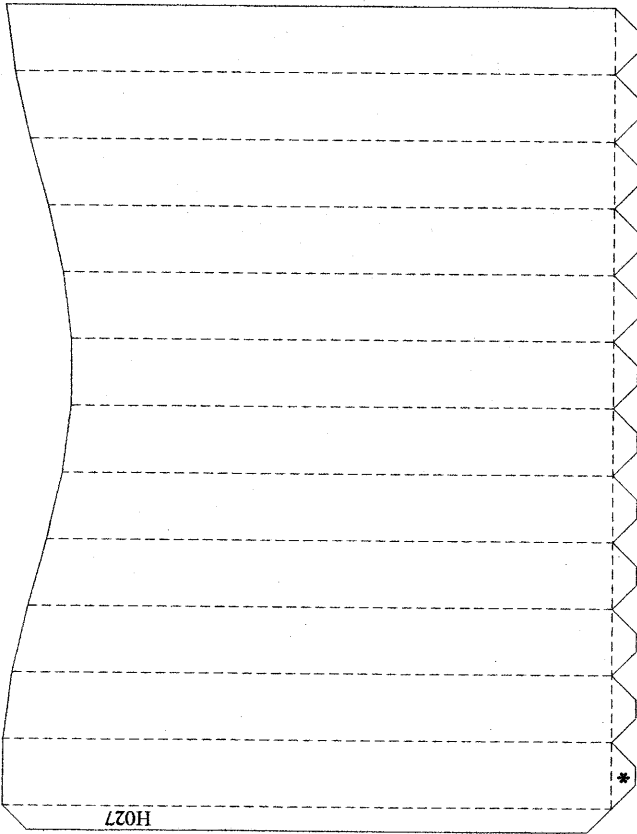
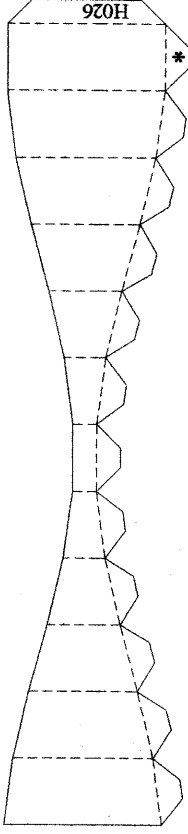
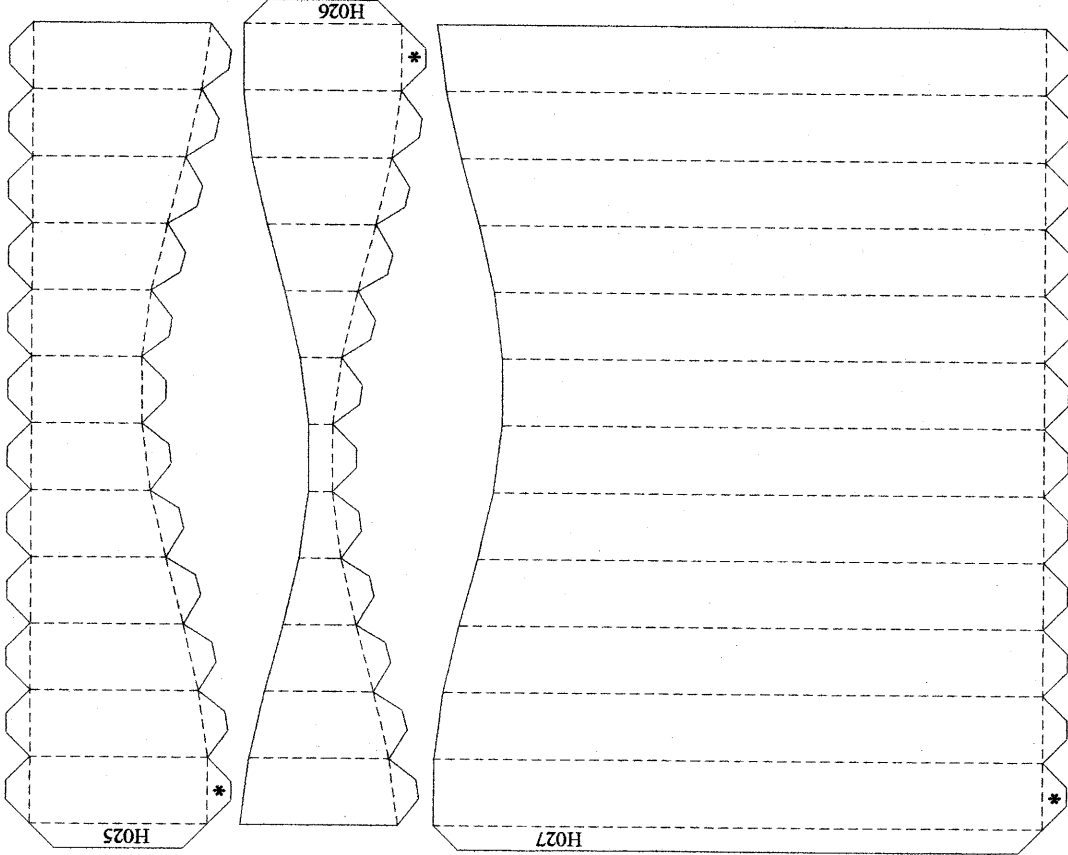

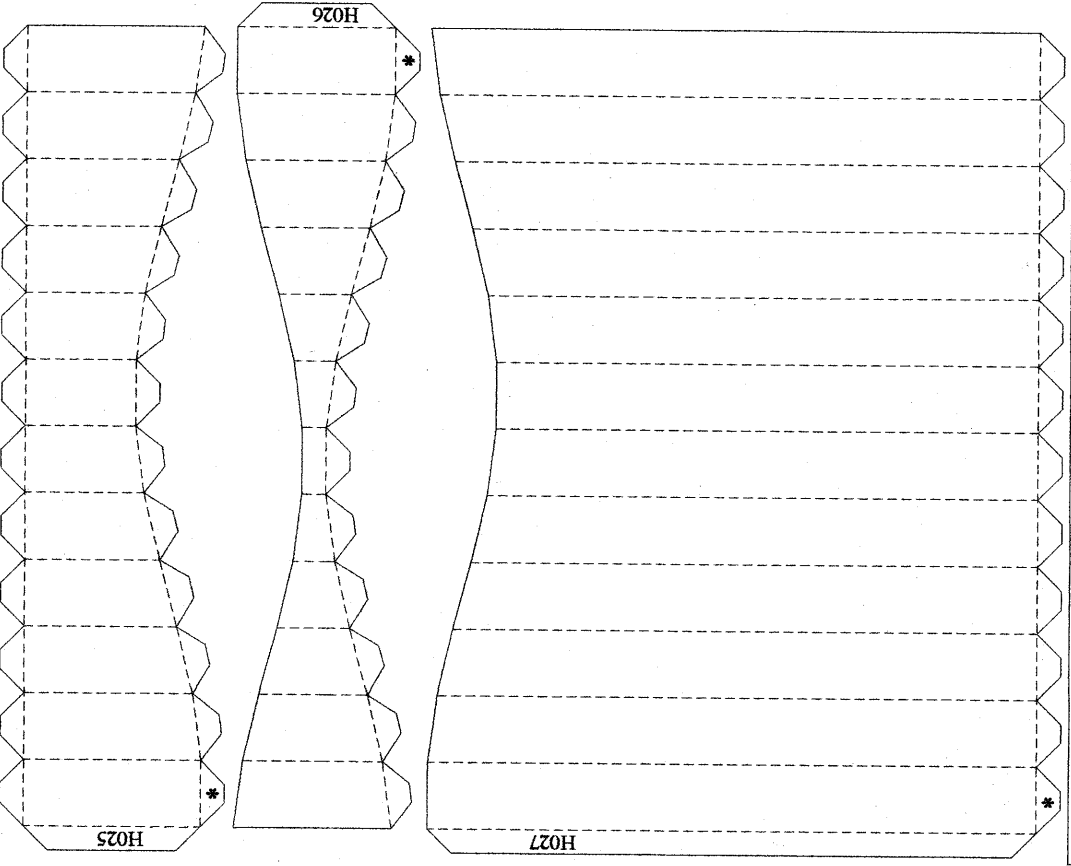
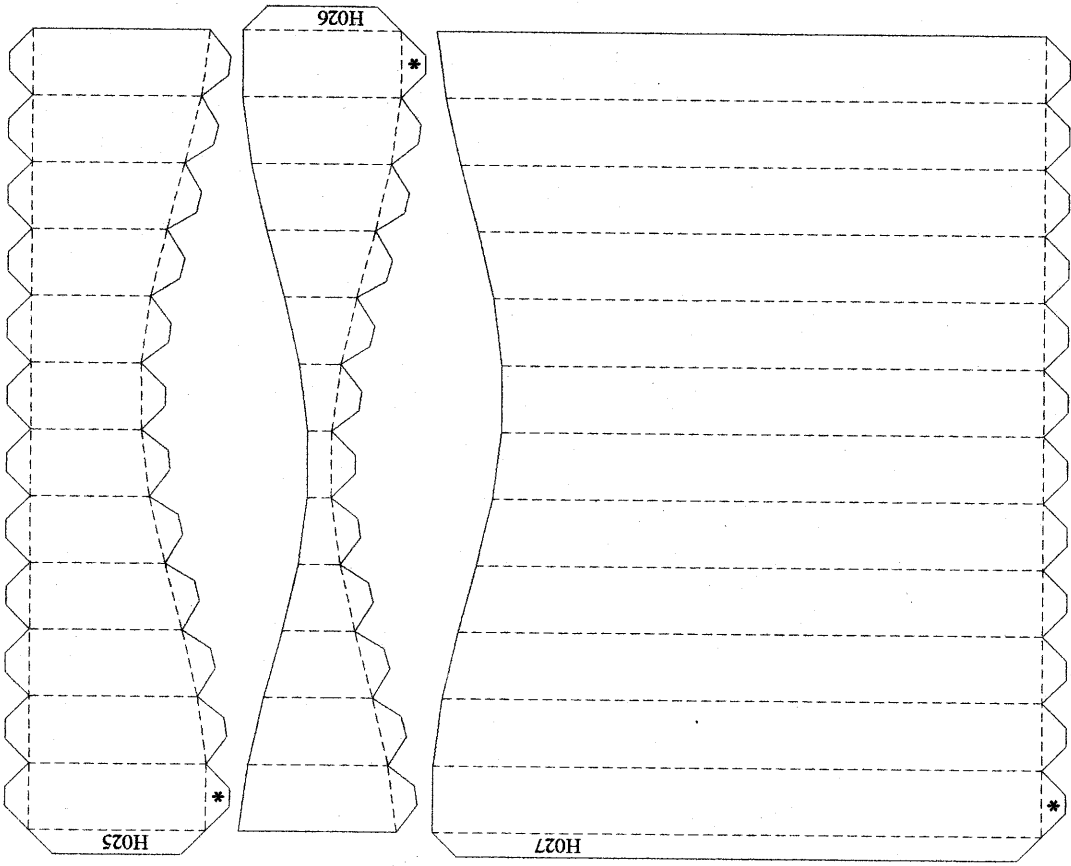

H028	
H029	
H029	
H028	
H029	
H029	

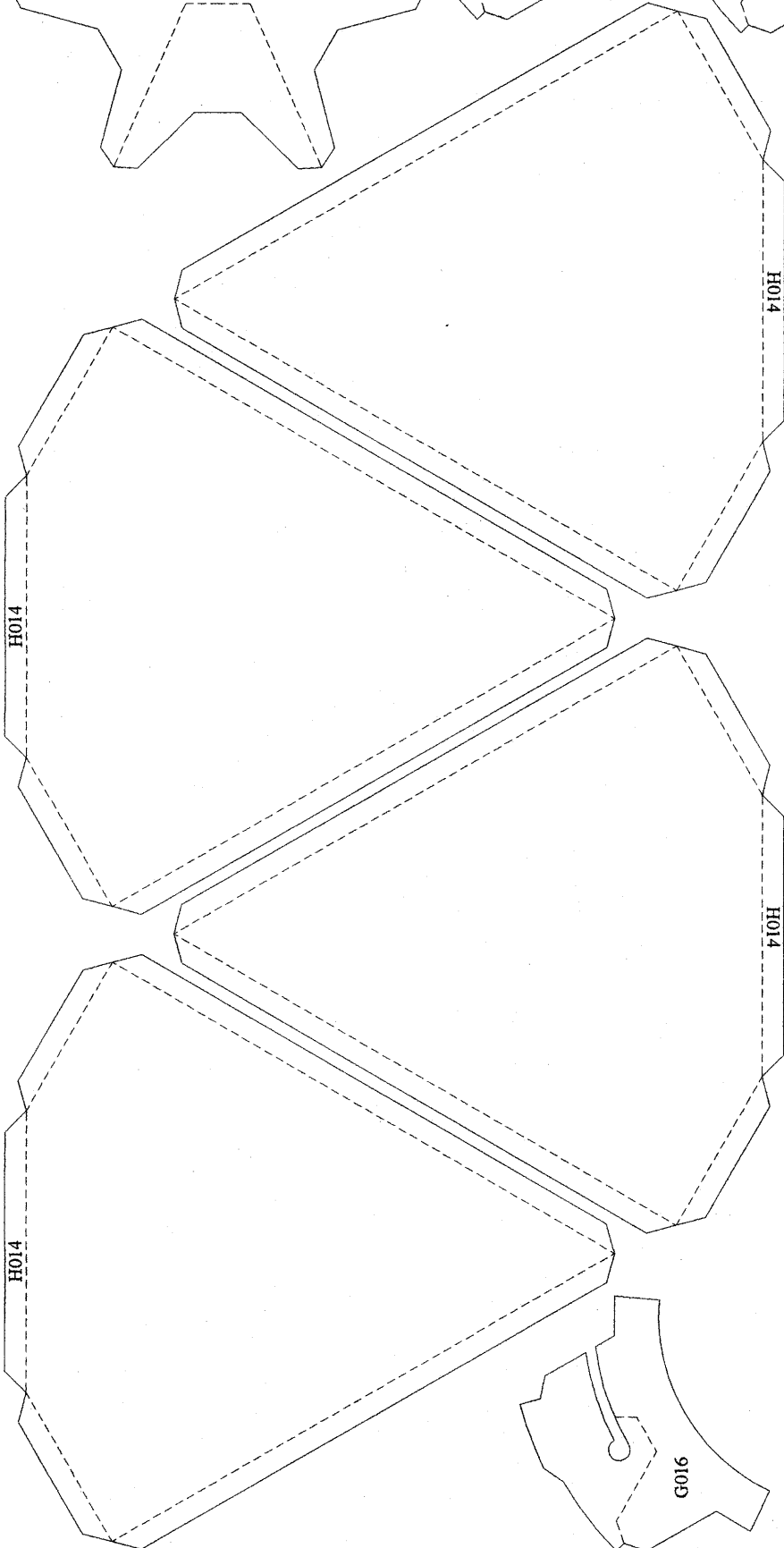
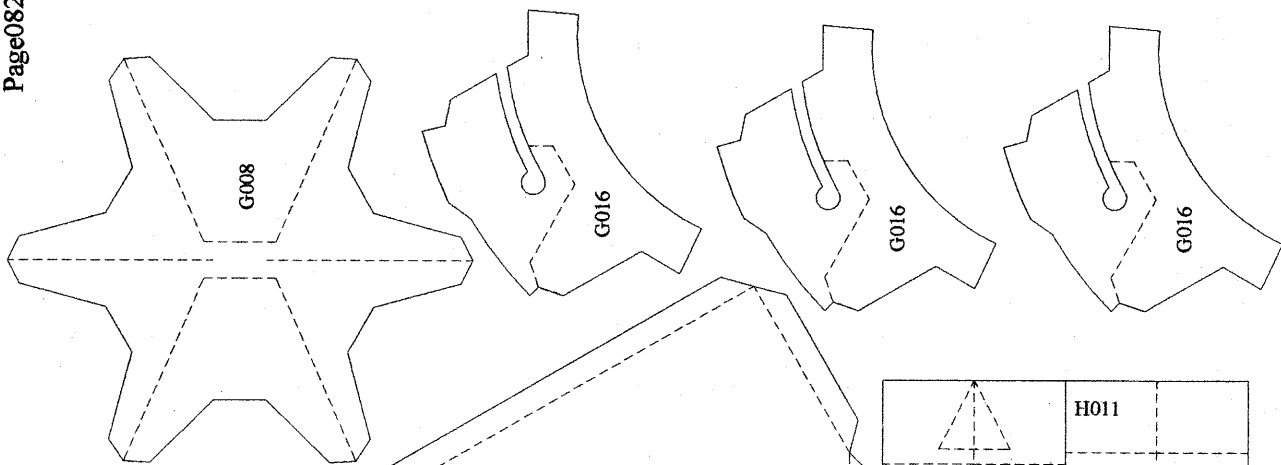

H028	
H029	
H029	
H028	
H029	
H029	



	H011
H010	

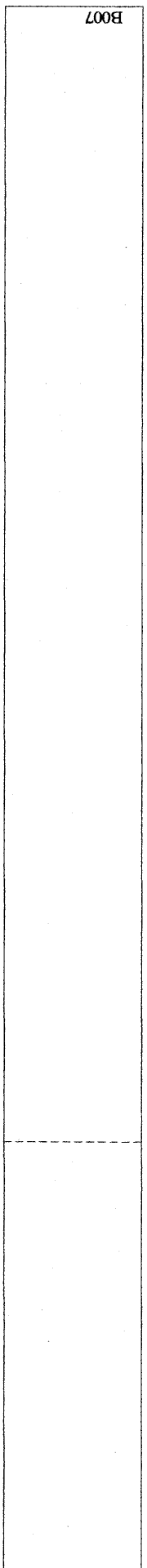

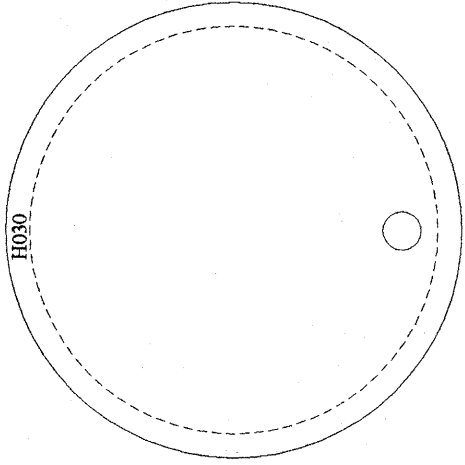
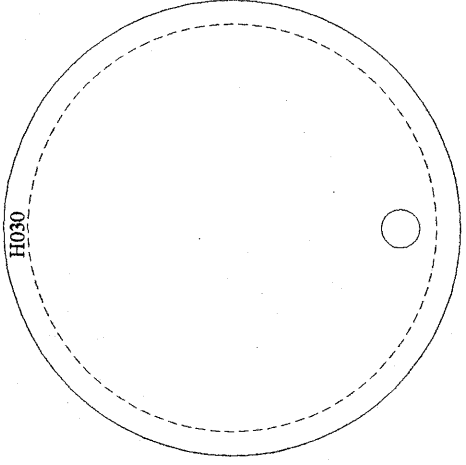
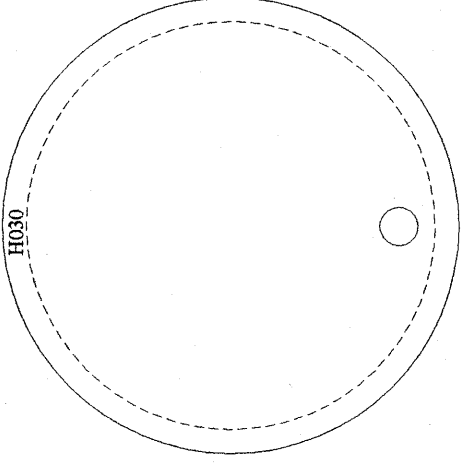
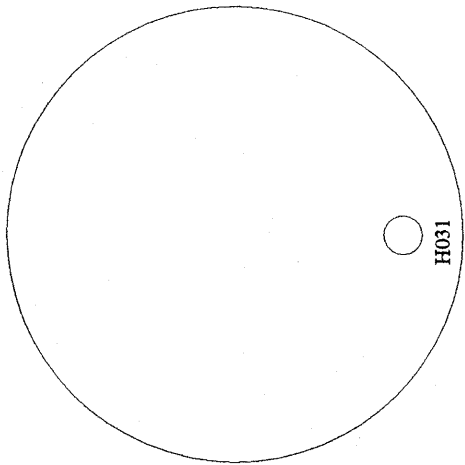
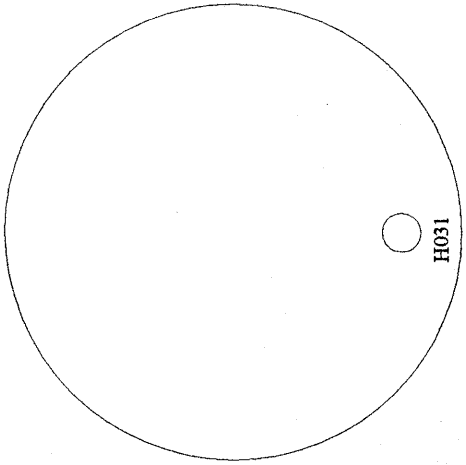
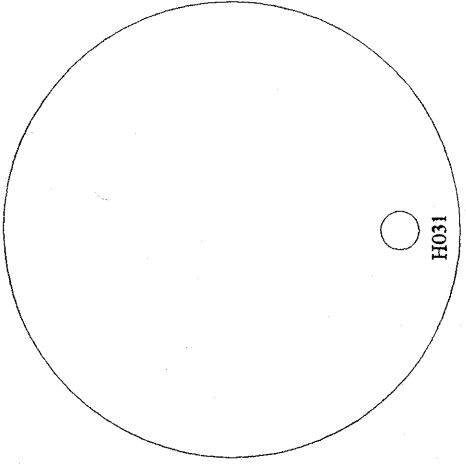
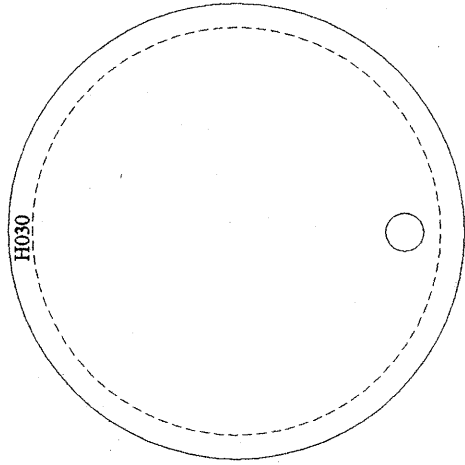
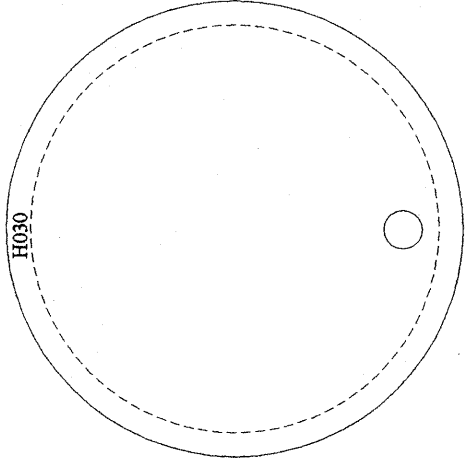
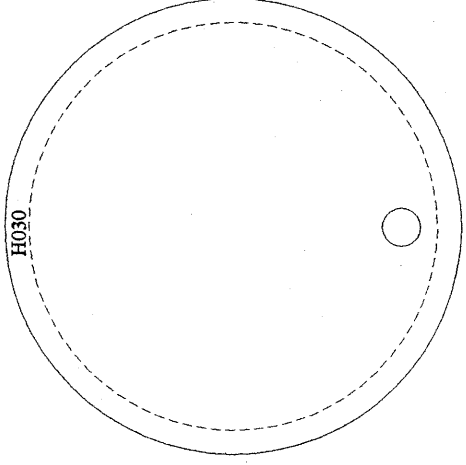
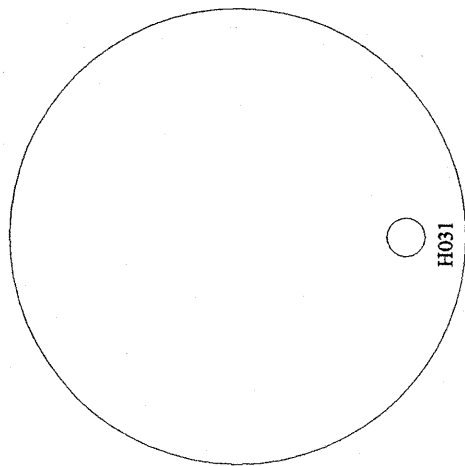
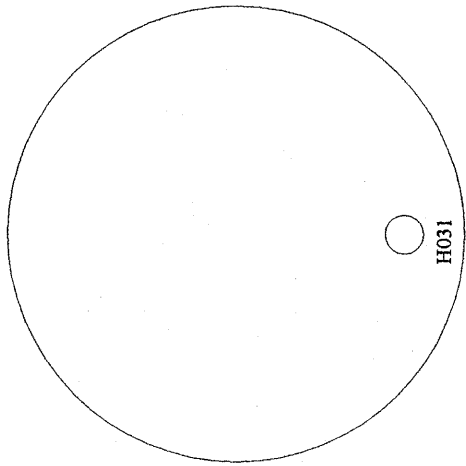
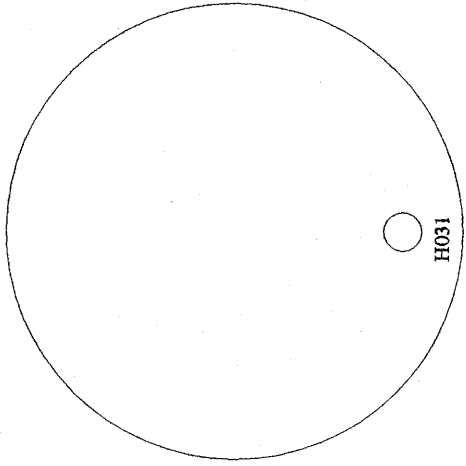



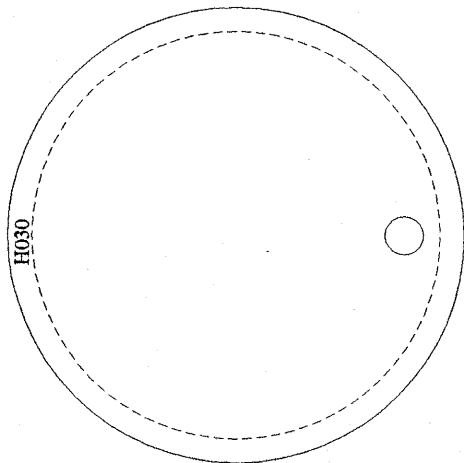
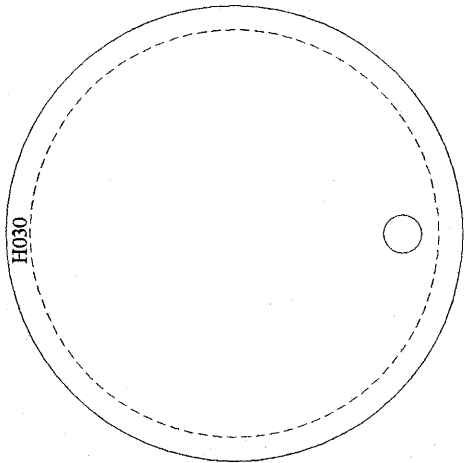
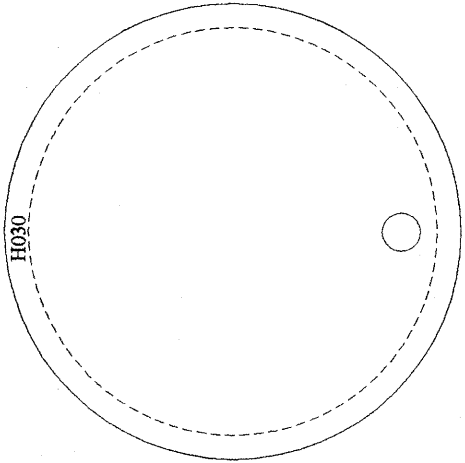
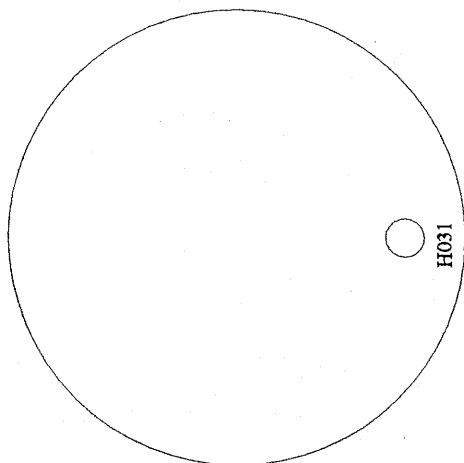
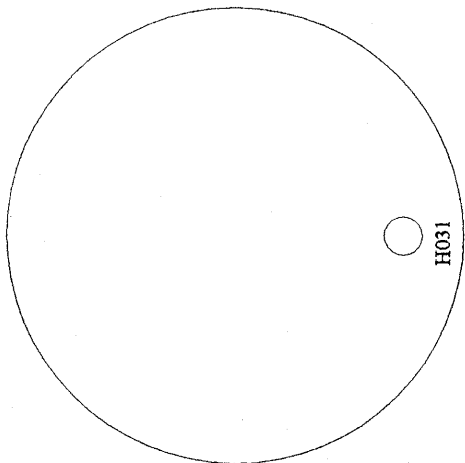
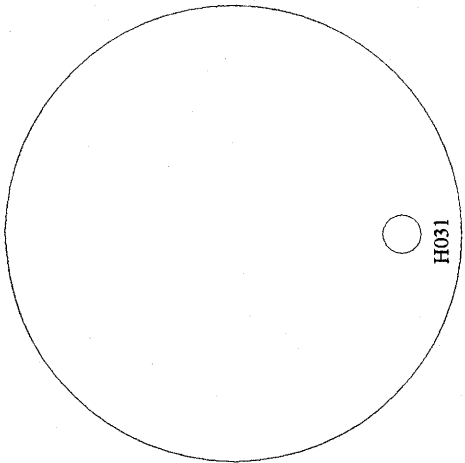
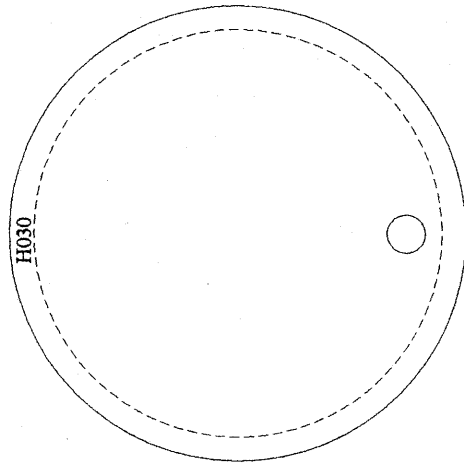
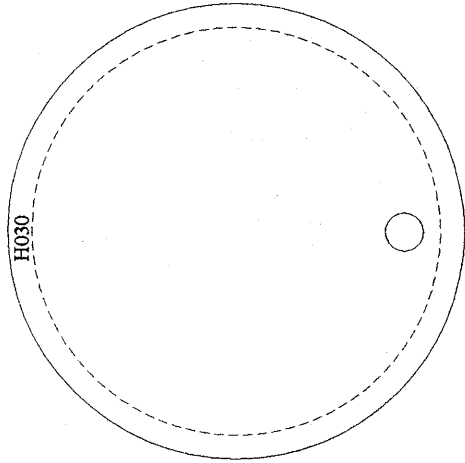
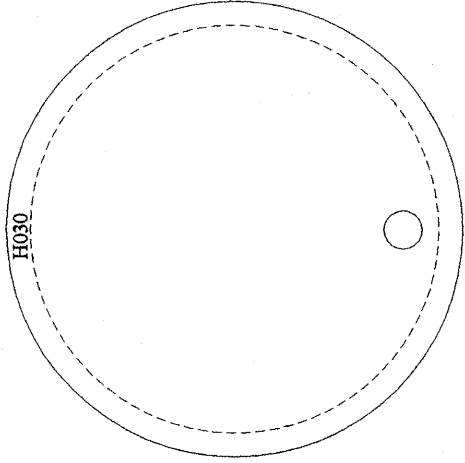
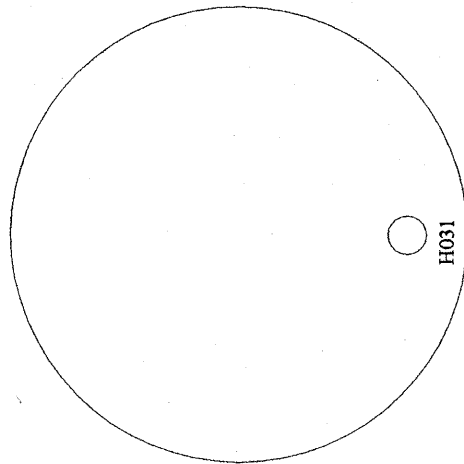
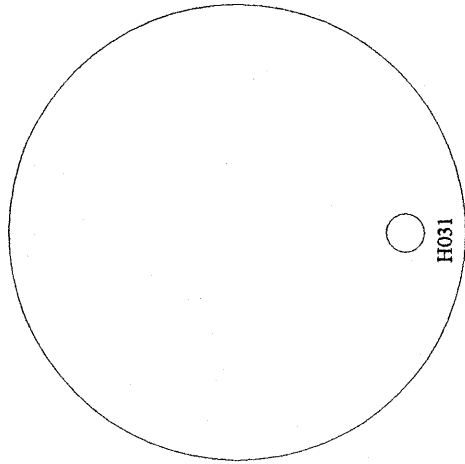
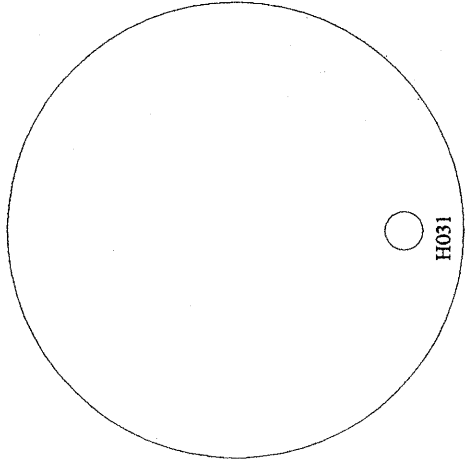



		H022
		H022
		H022

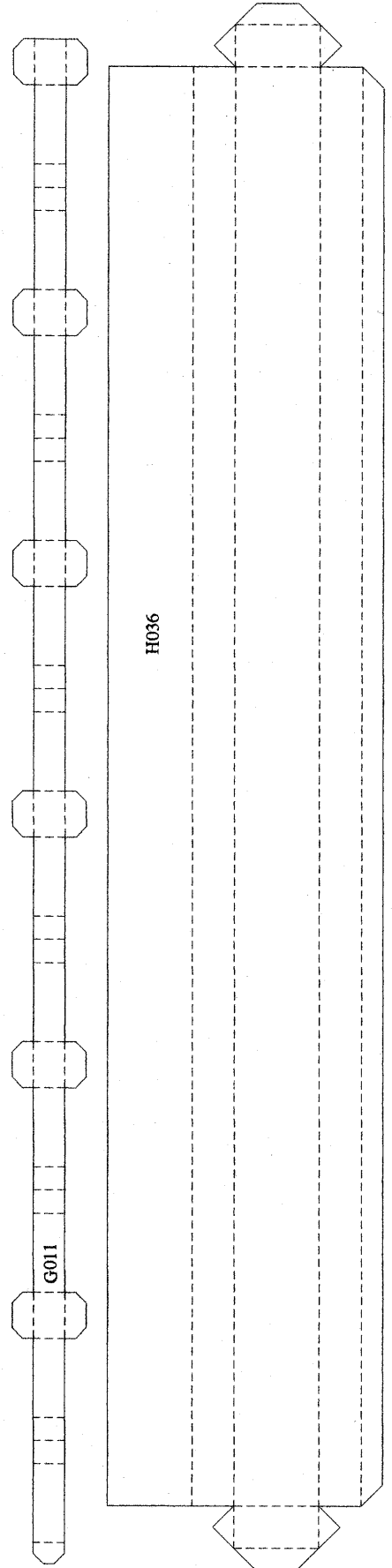
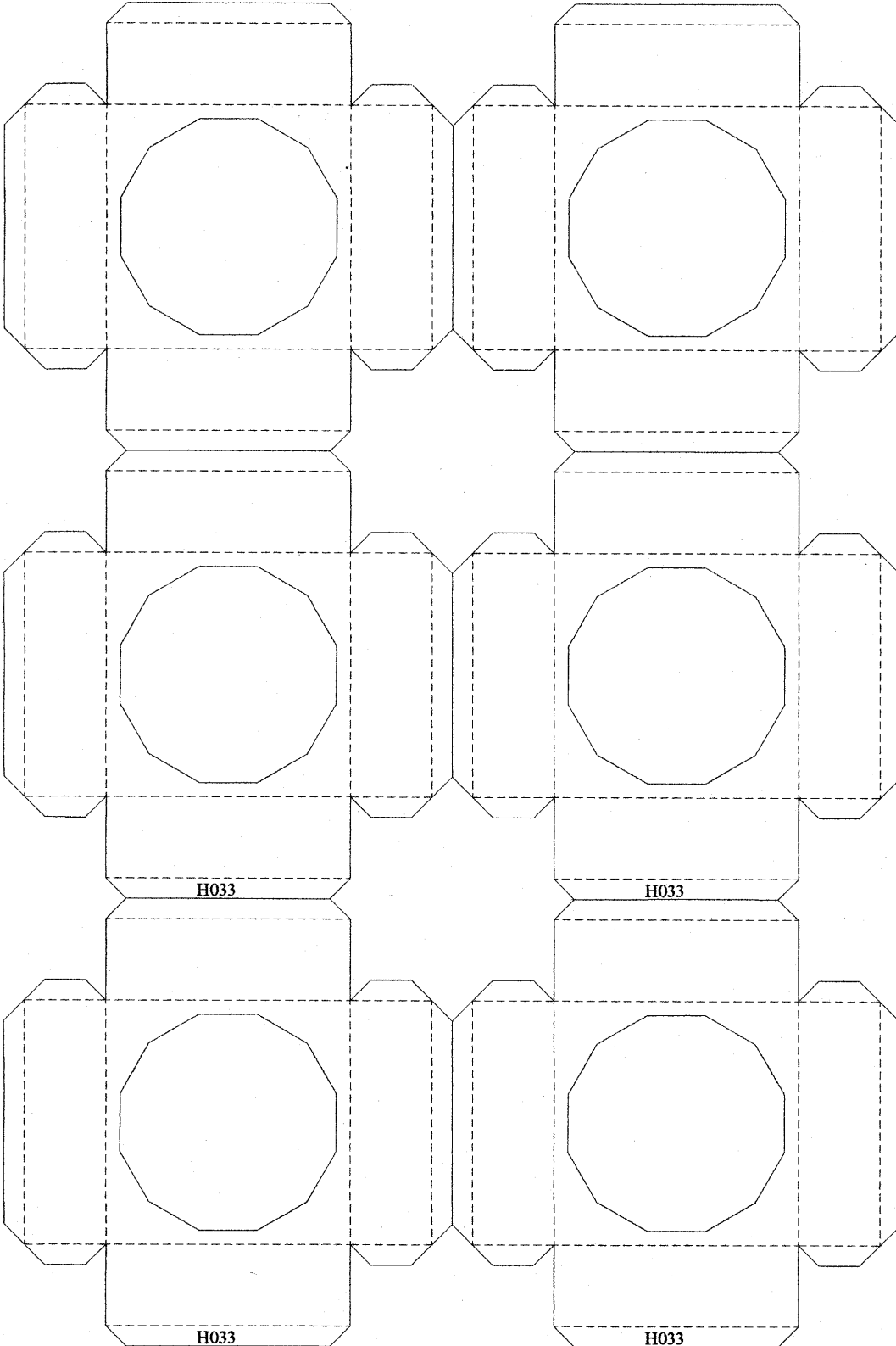

CS10

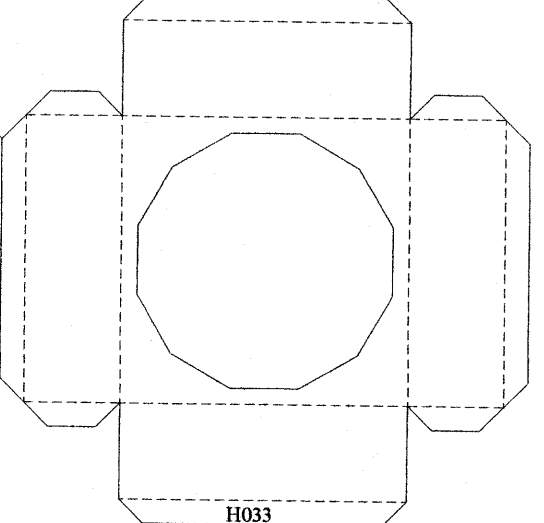
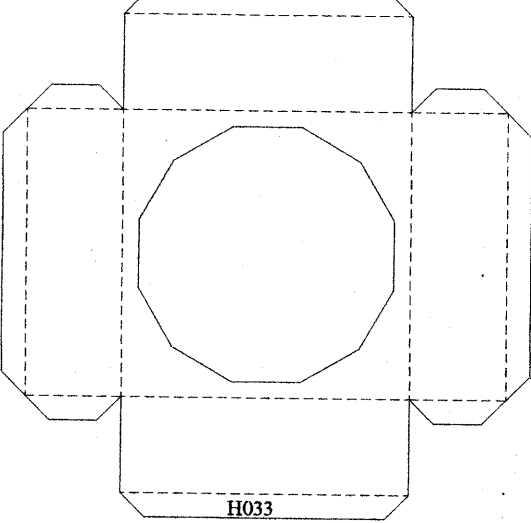
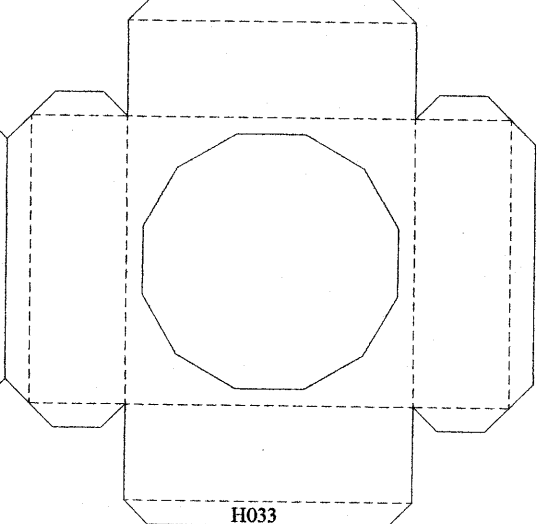
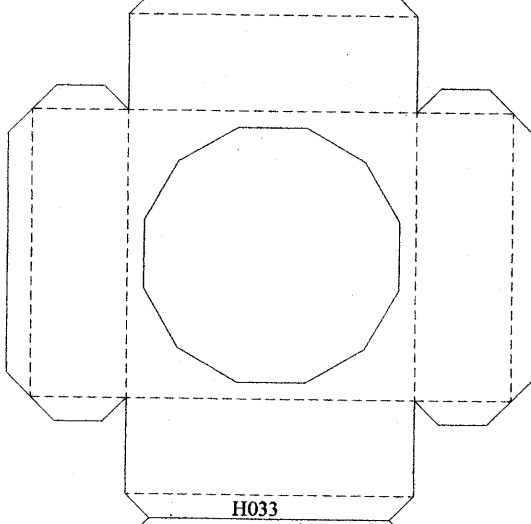
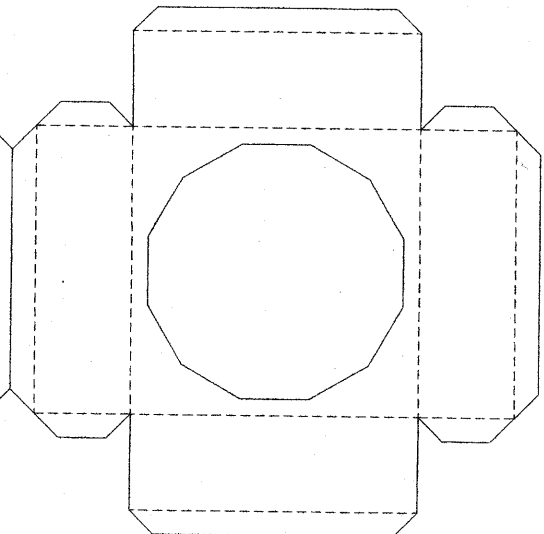
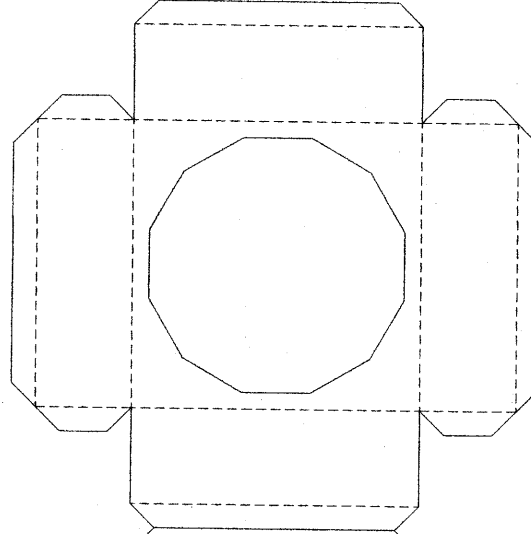
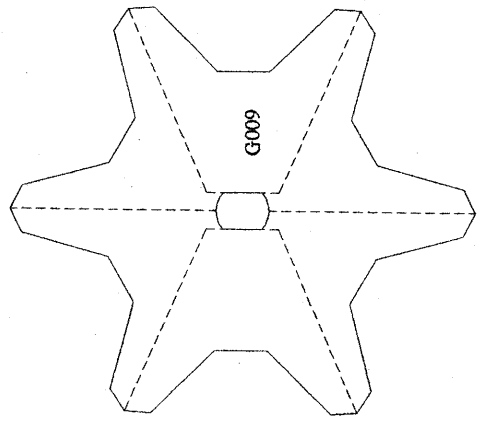
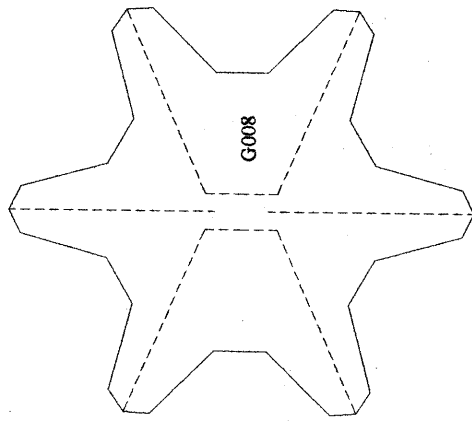

CS10

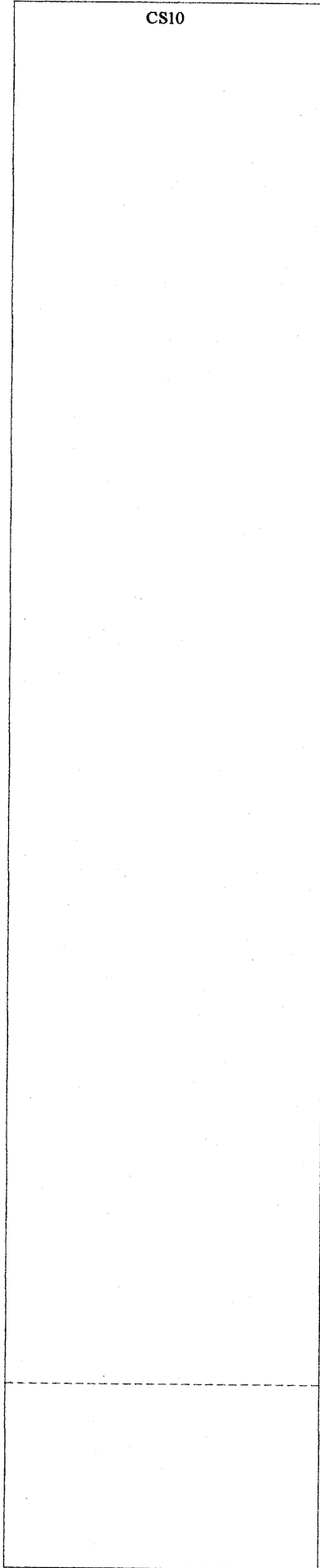
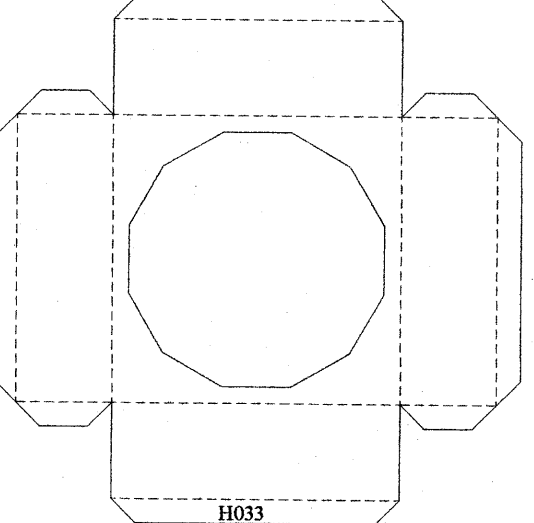
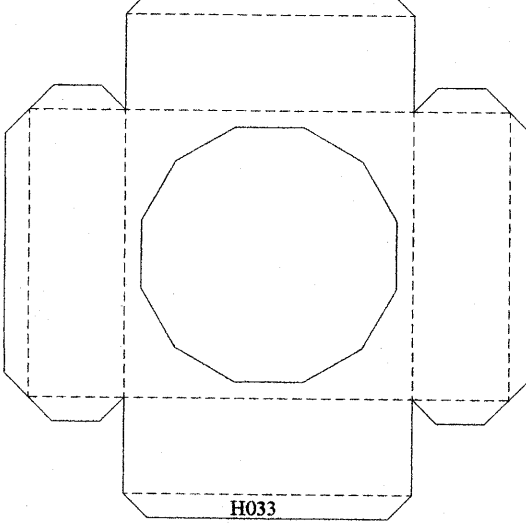
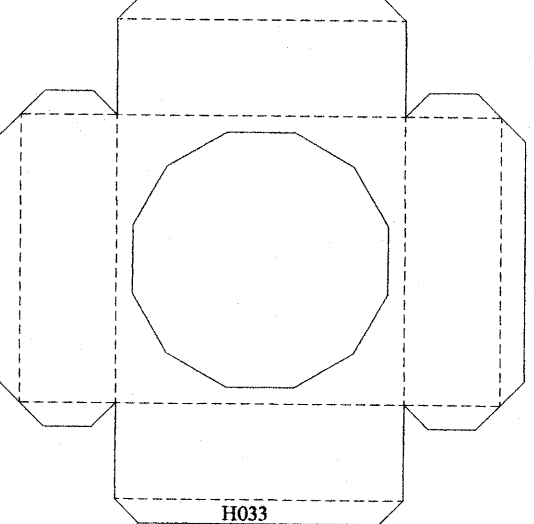
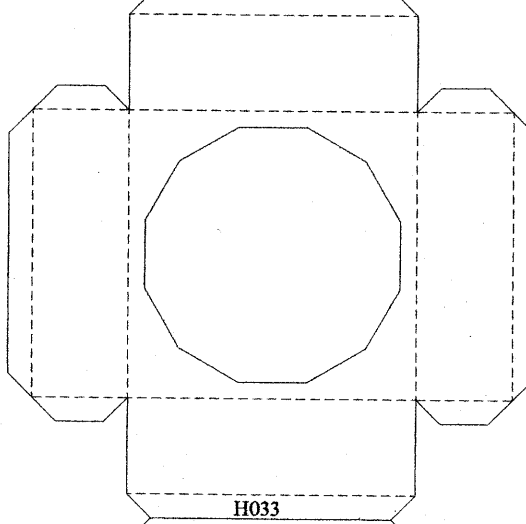
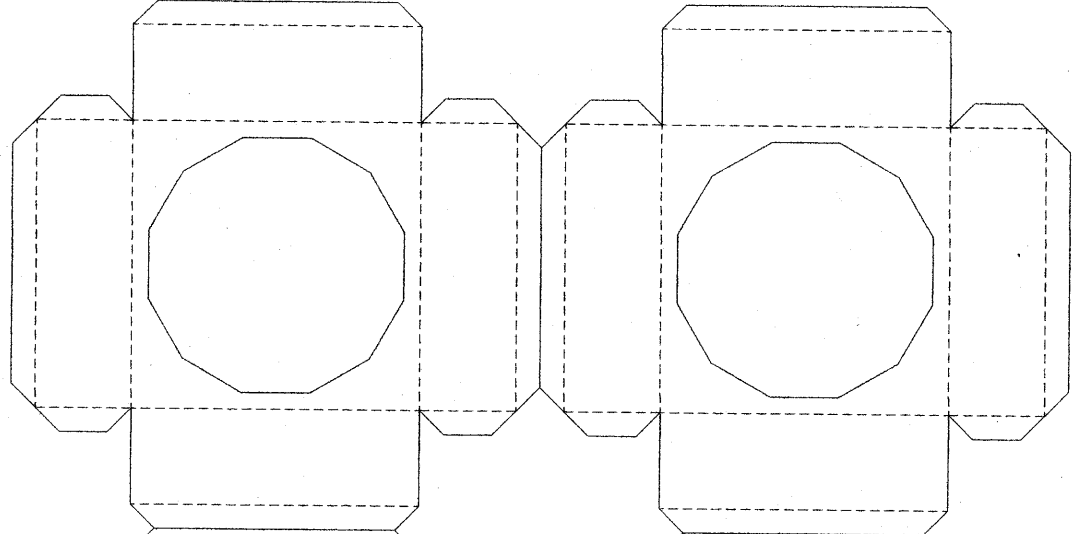
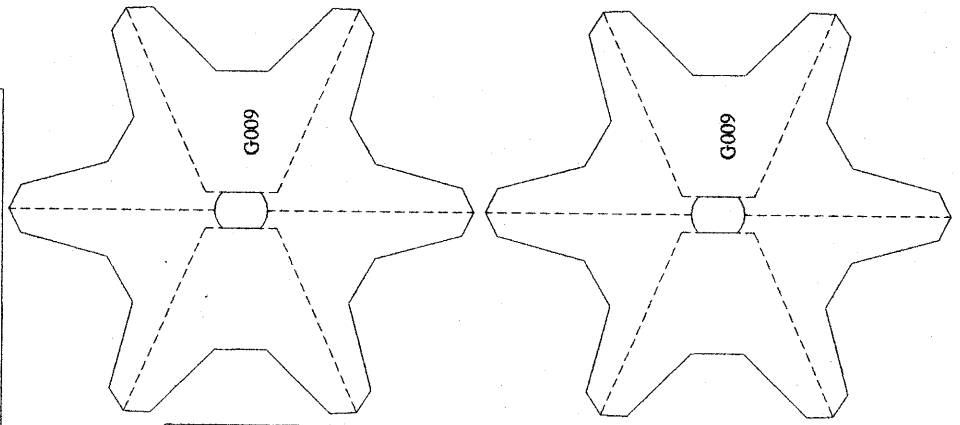

CS10

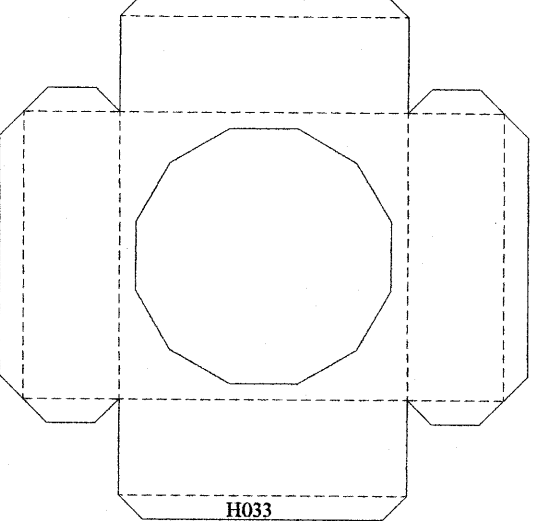
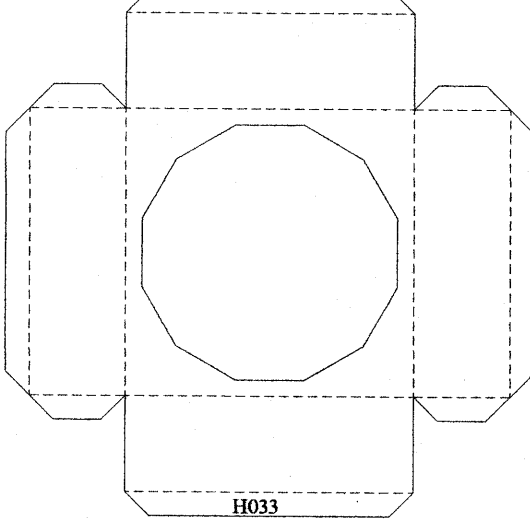
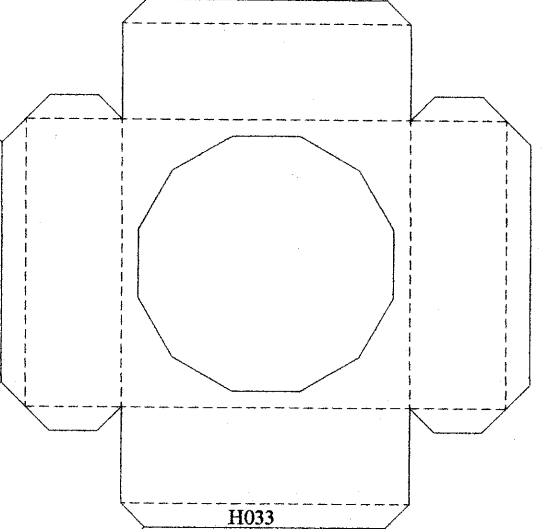
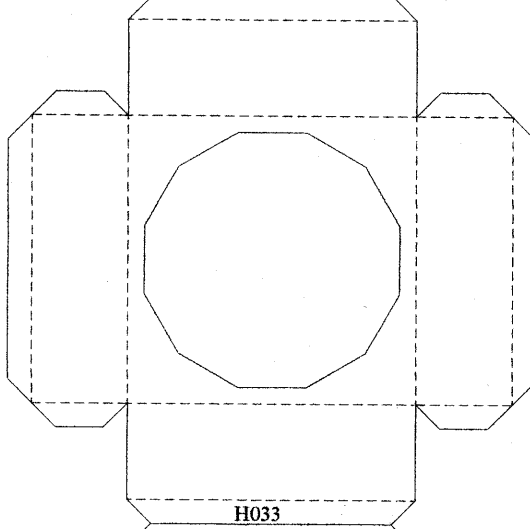
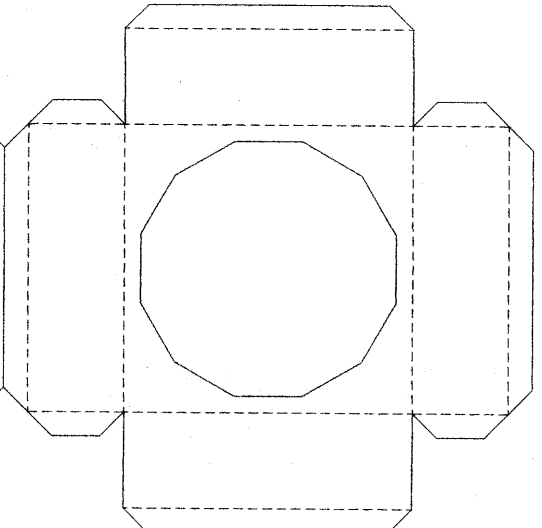
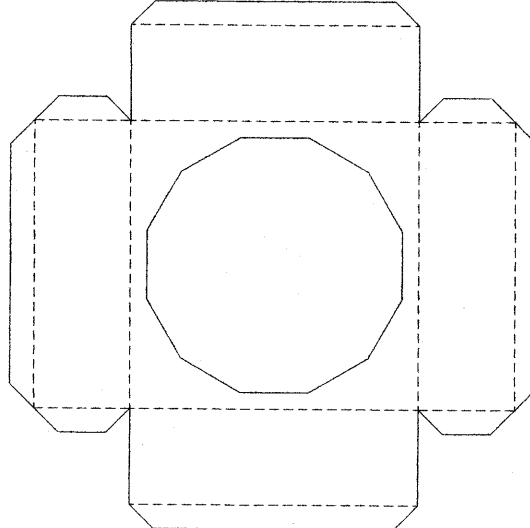
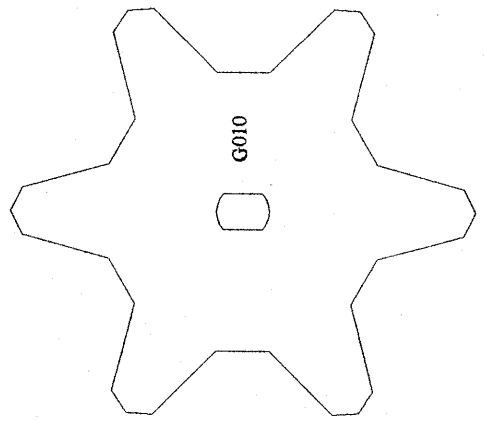
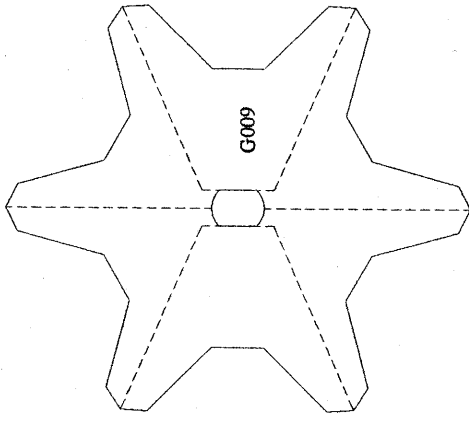

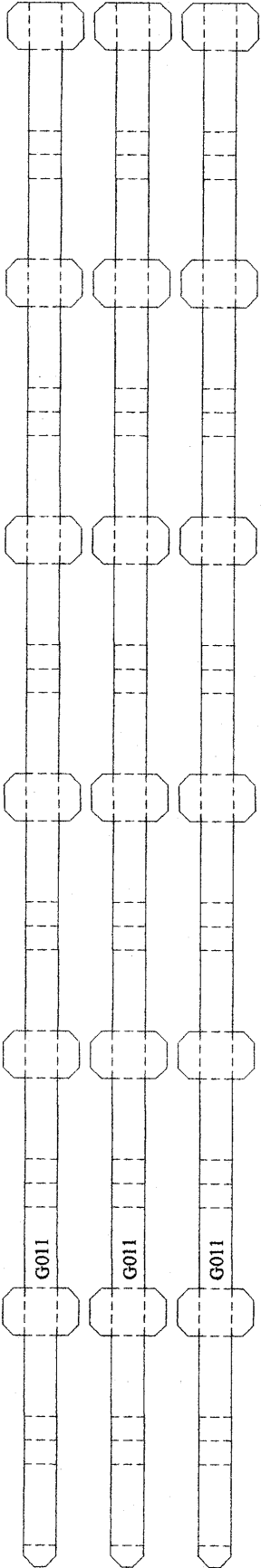

CS10	CS10	CS10

CS11	CS11	CS11
------	------	------



CS11	CS11	CS11
------	------	------

CS11	CS11	CS11
------	------	------

CS11	CS11	CS11

CS11	CS11	CS11

CSA01	CSA01	CSA01	CSA01

CSA03	CSA03	CSA03	CSA03
-------	-------	-------	-------

CSA03	CSA03	CSA03	CSA03
-------	-------	-------	-------

CSA03	CSA03	CSA03	CSA03
-------	-------	-------	-------



CSA03	CSA03	CSA03	CSA03
-------	-------	-------	-------

G025	CSB02	CSB02	CSB01
------	-------	-------	-------

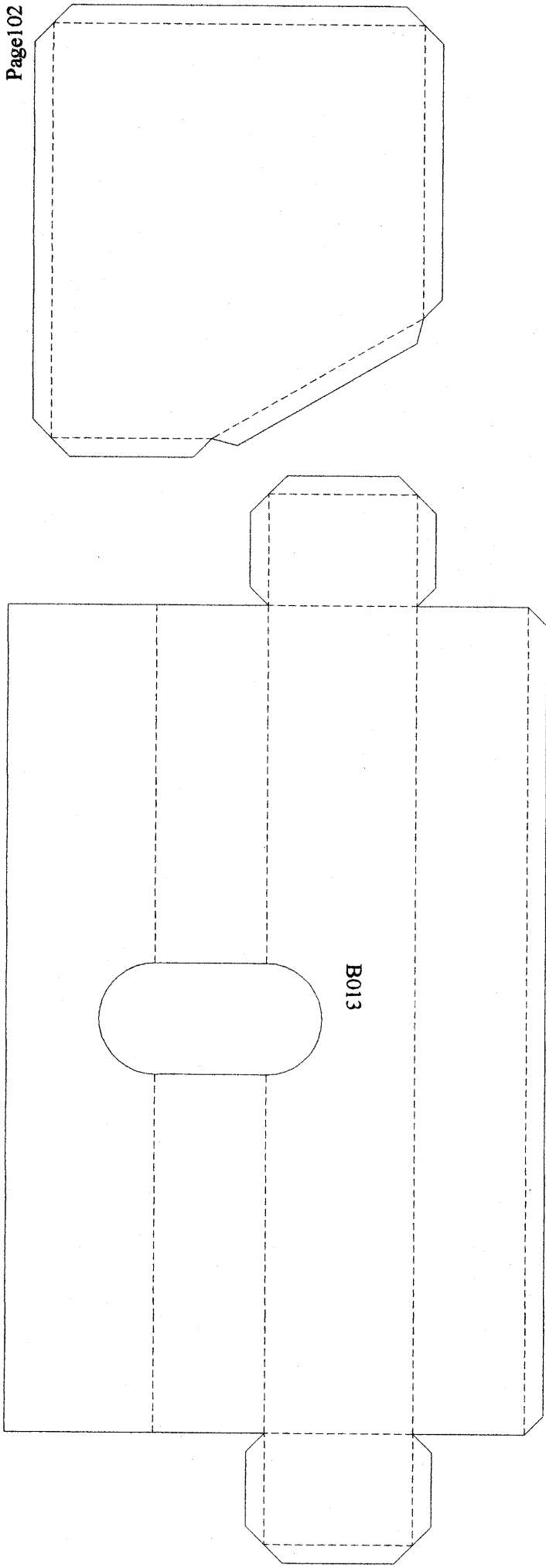

CSB02	CSB02
-------	-------

CSC02	CSC02	CSC02	CSC01	CSC01

CSC02

CSC02

CSC02

CSC02

CSC02

		H022
		H022

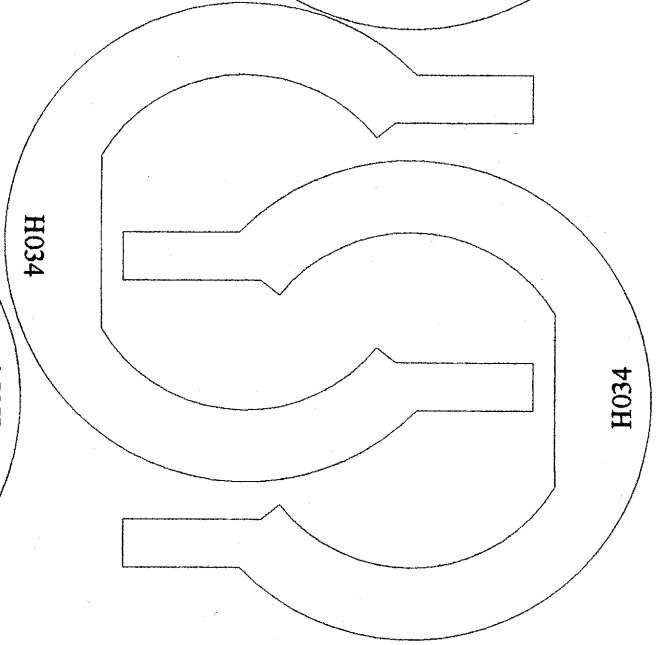
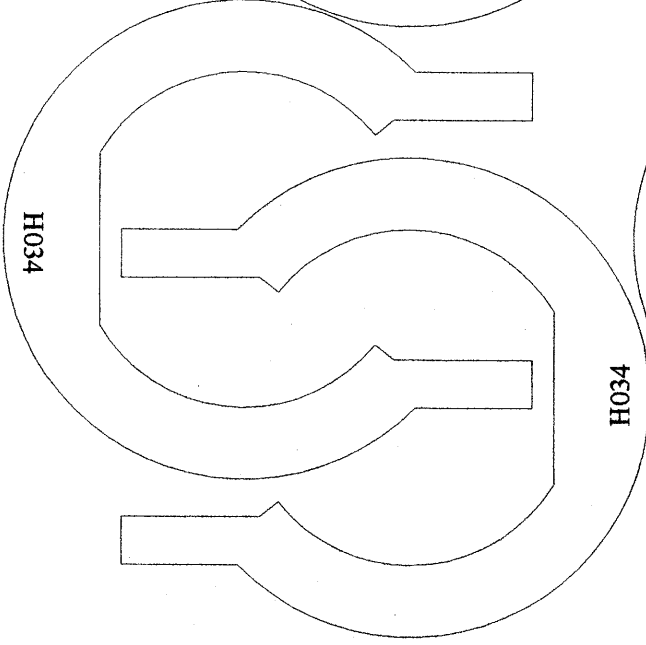
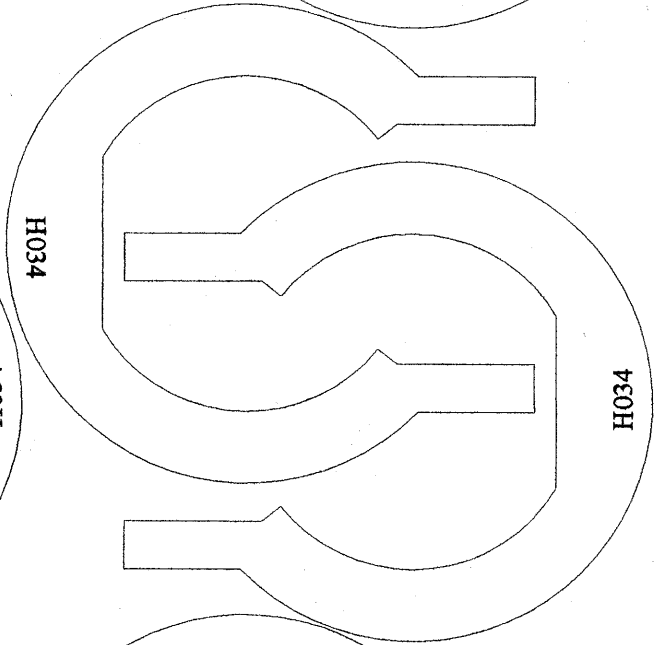
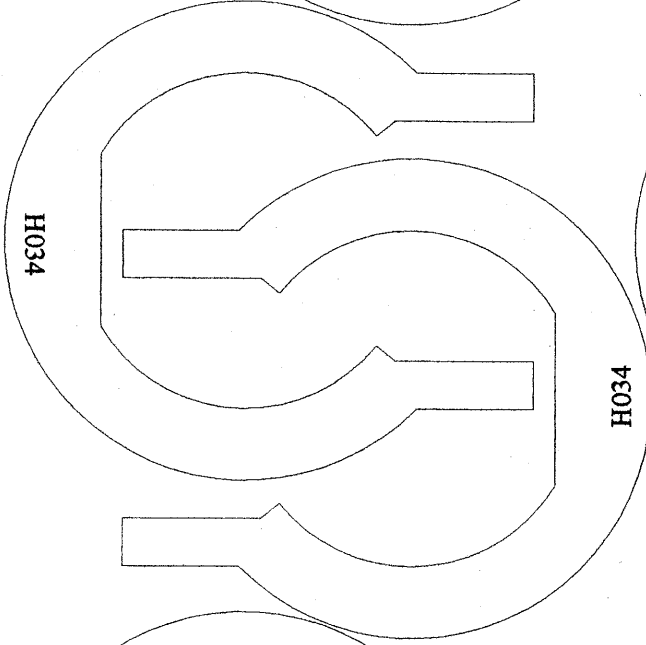
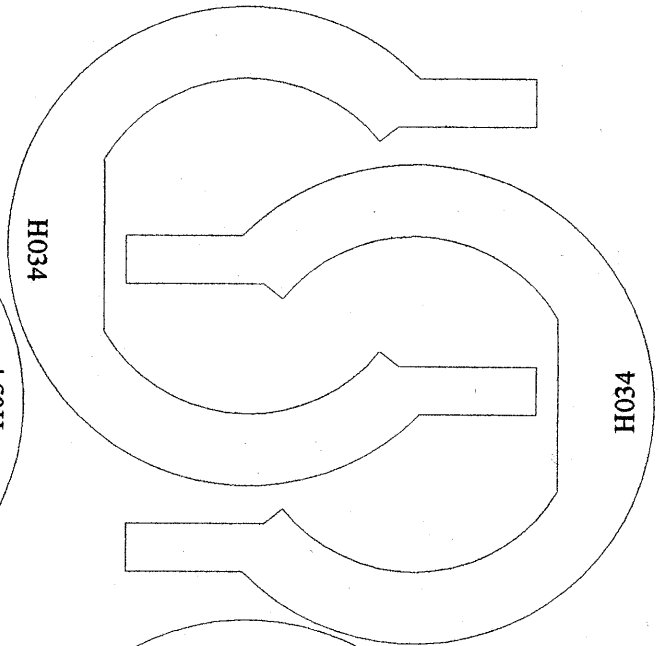
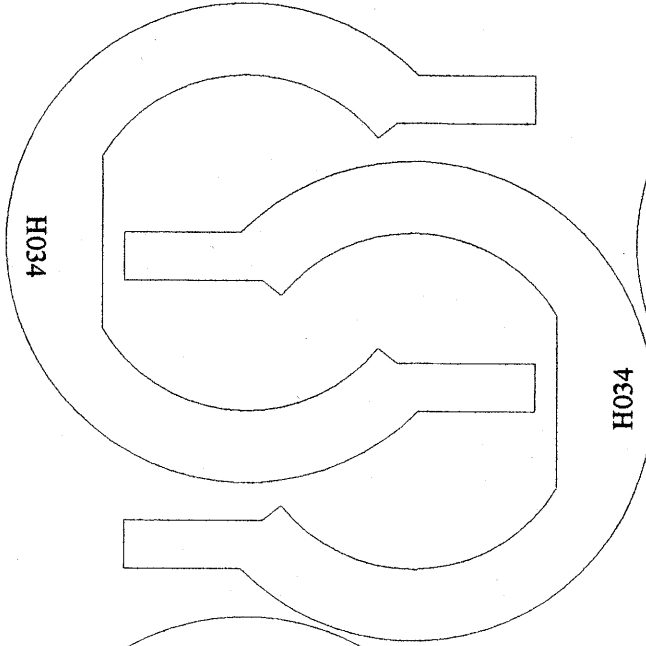

		H022
		H022
		H022

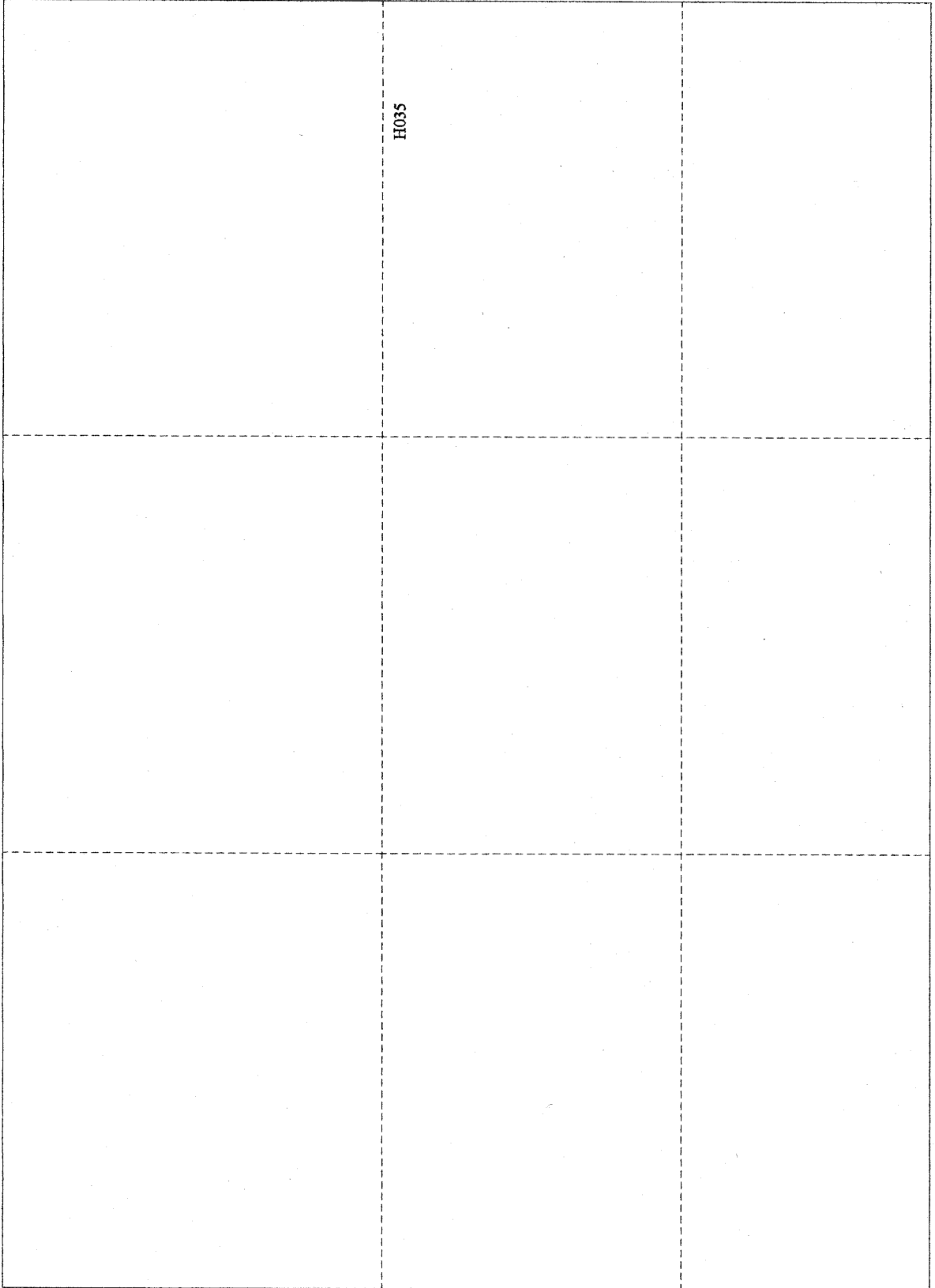
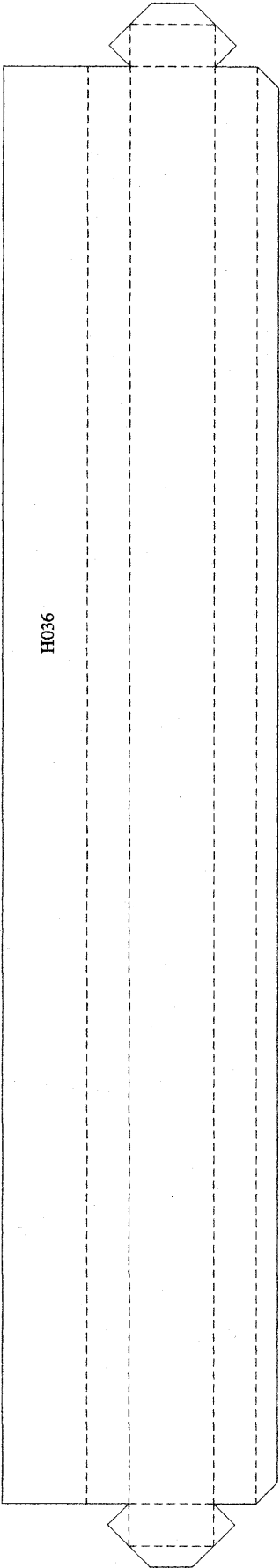

		H022
		H022
		H022

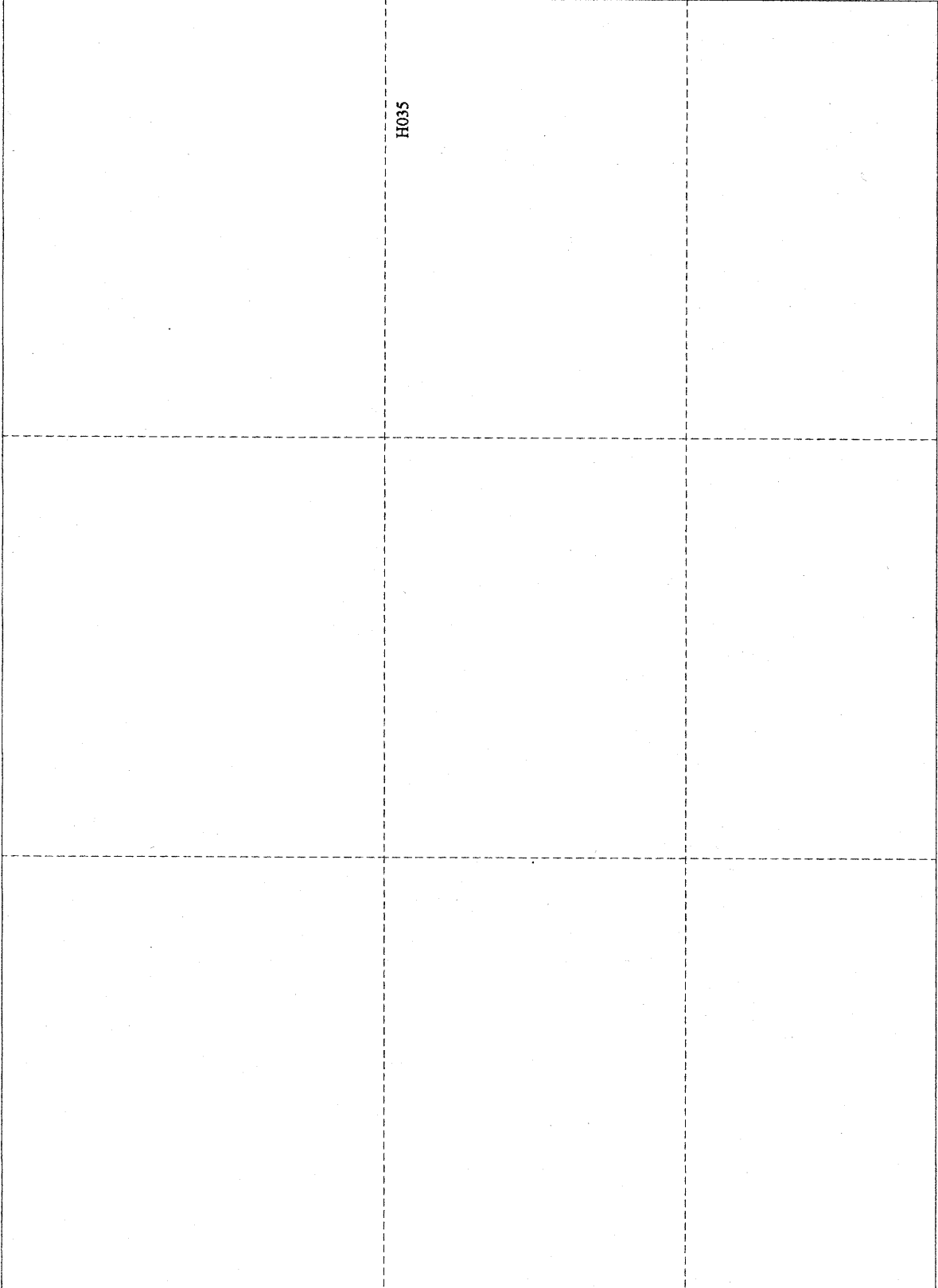
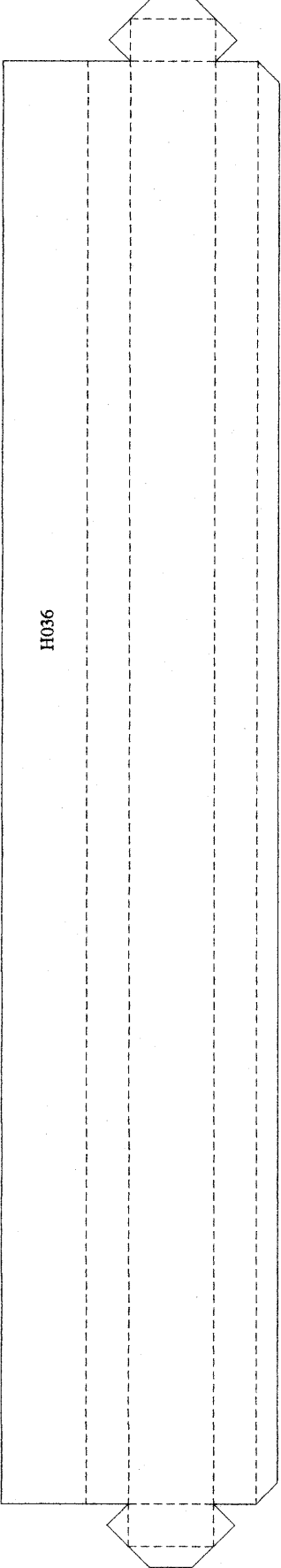



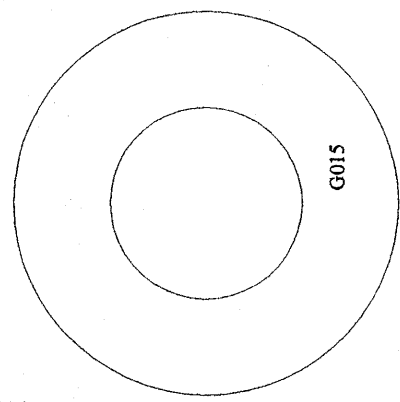
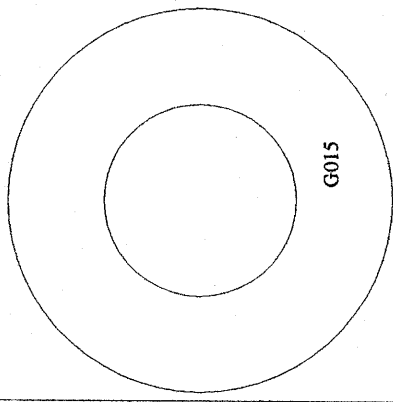
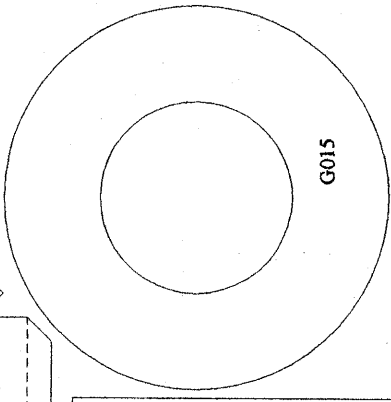
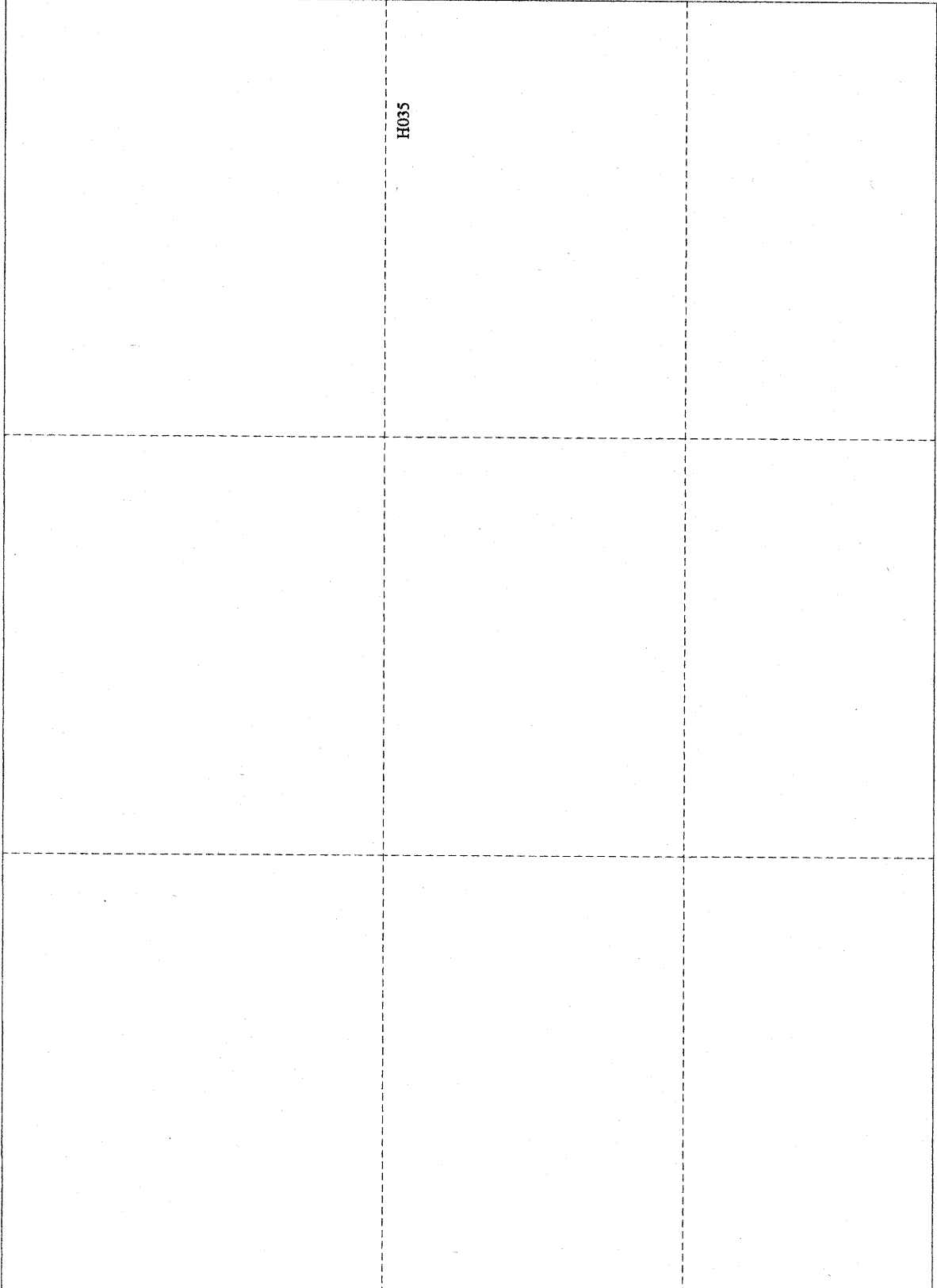
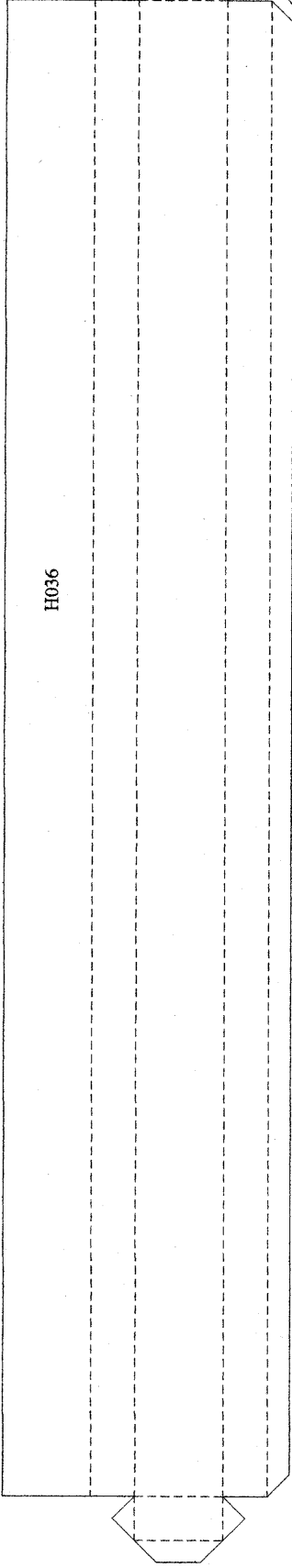

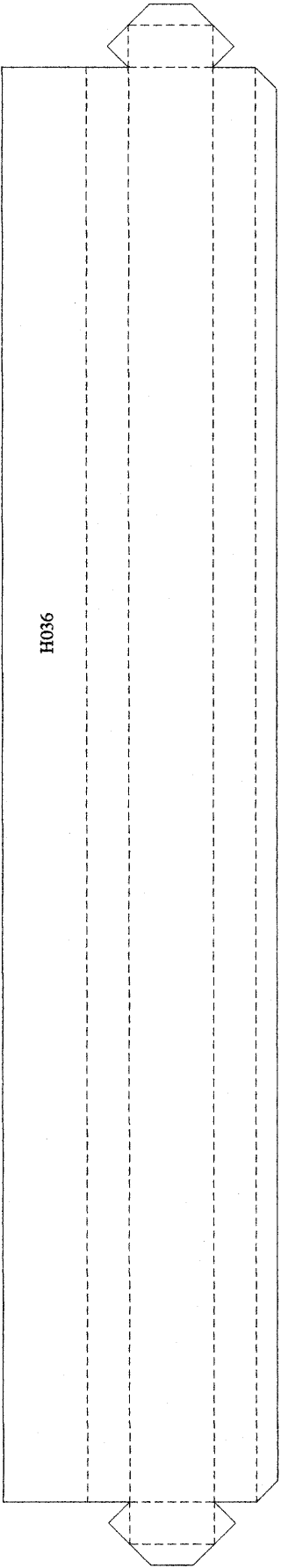

H036

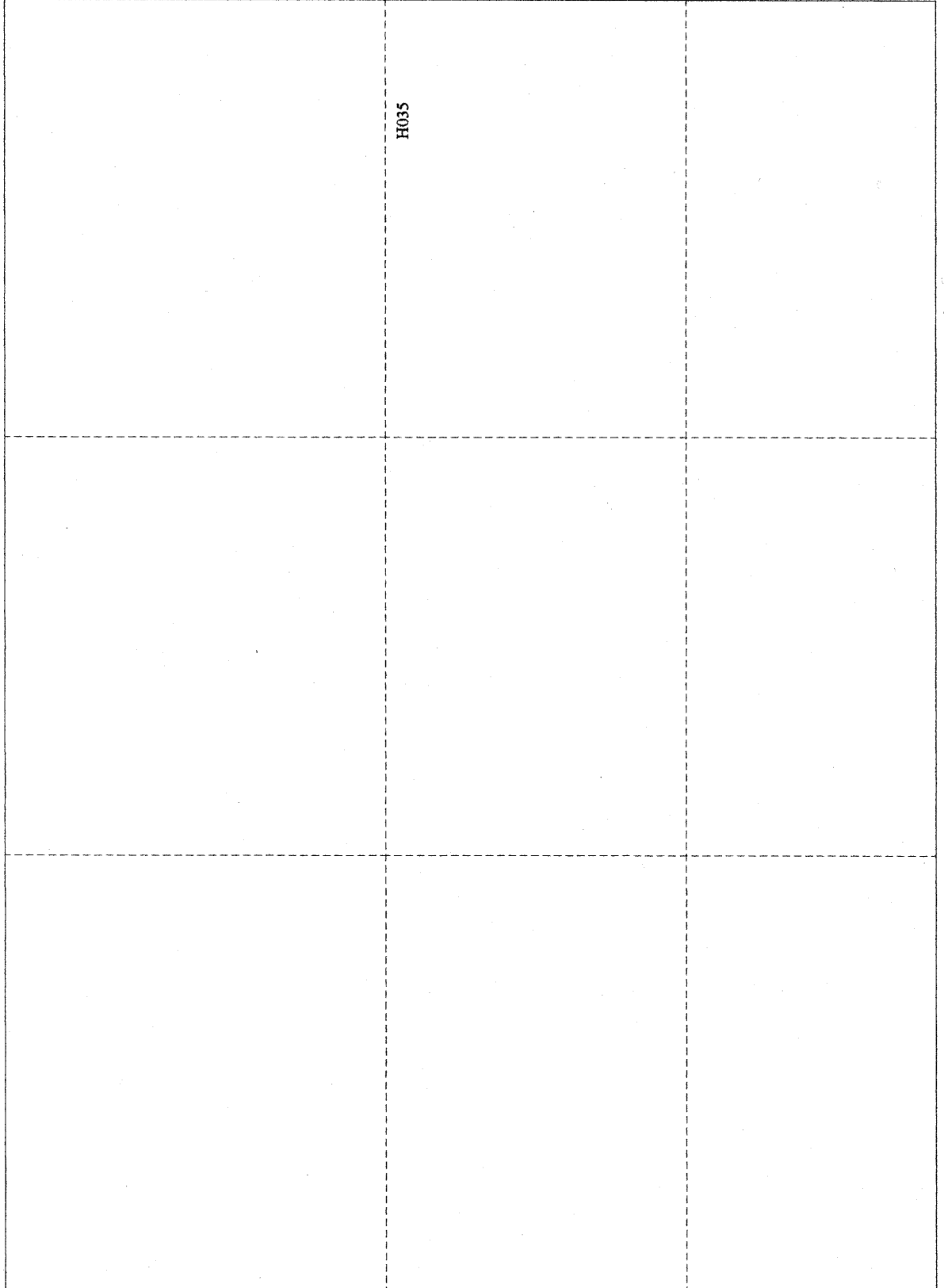

H035



		H022
		H022

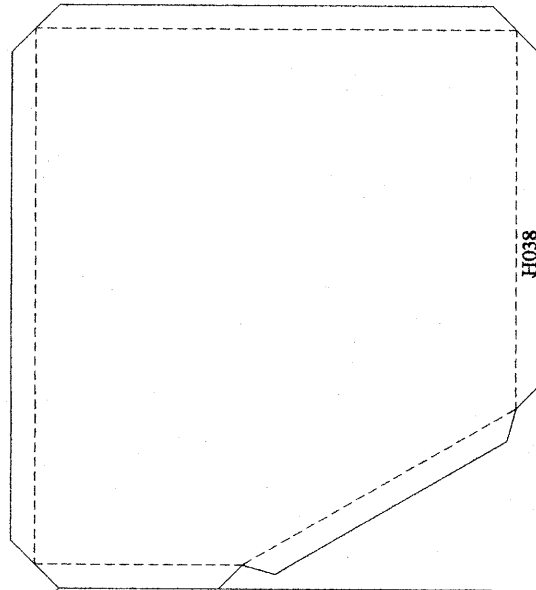
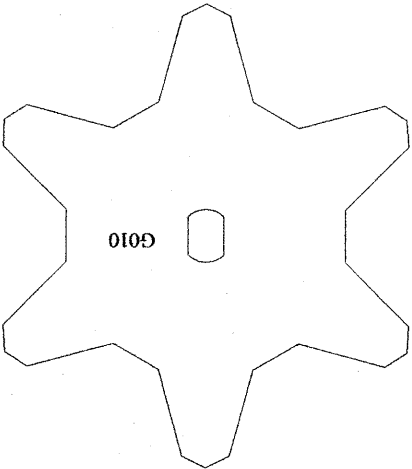
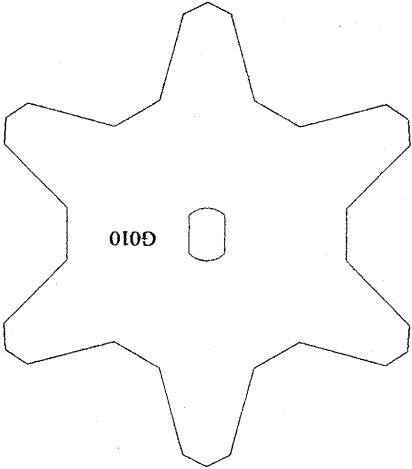
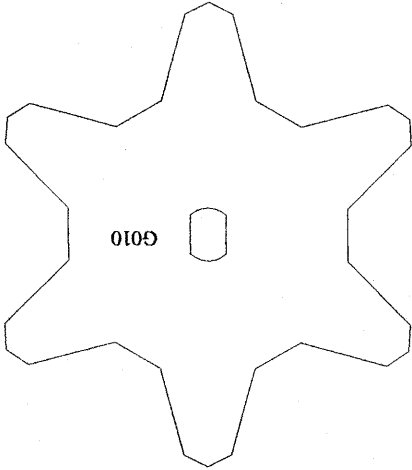
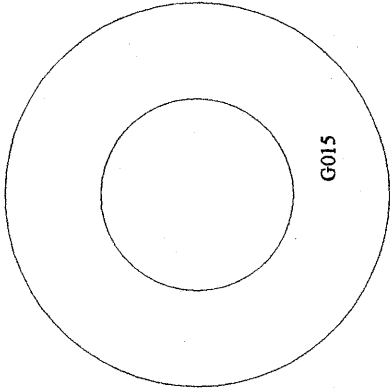

8E01F

H038

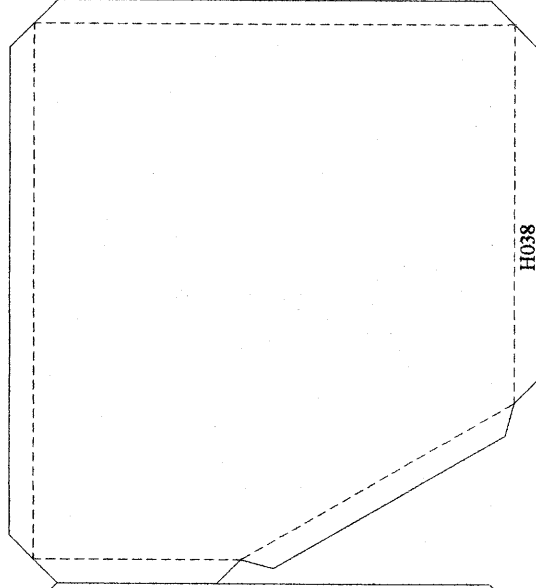

8E01H

H038

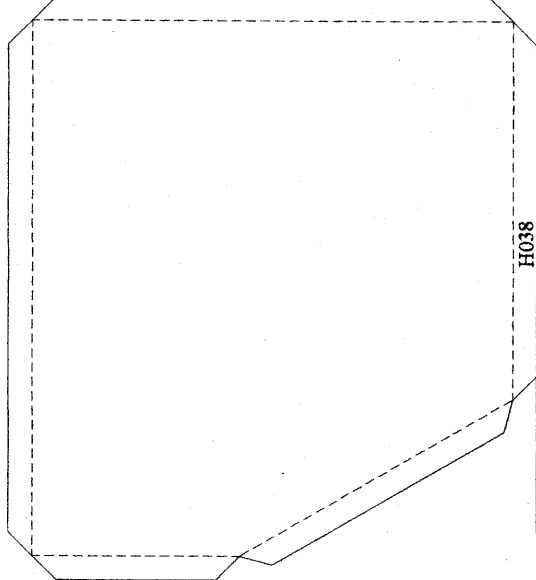

8E01F

H038

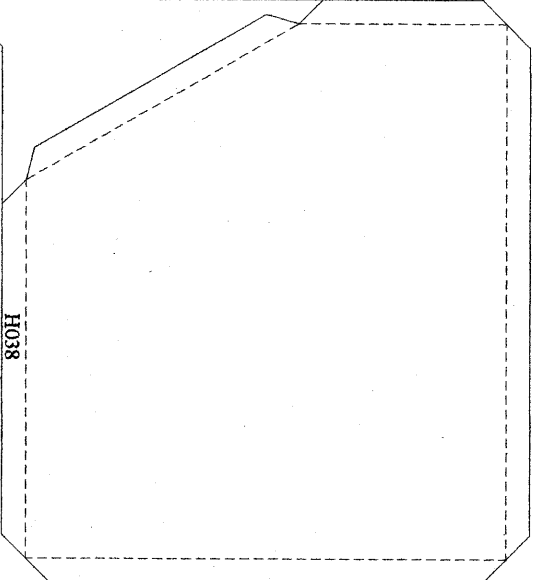
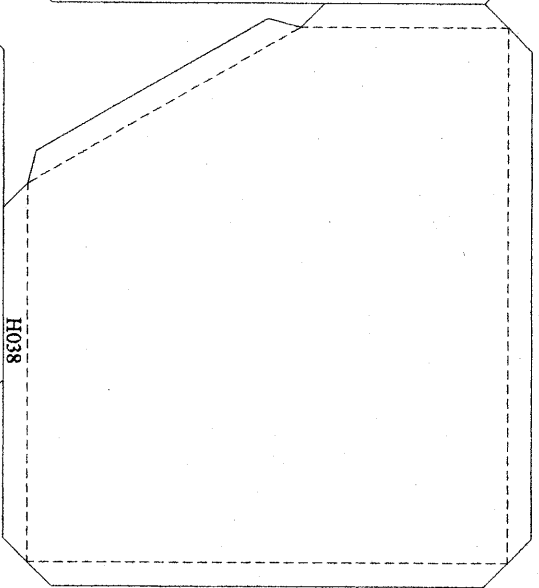
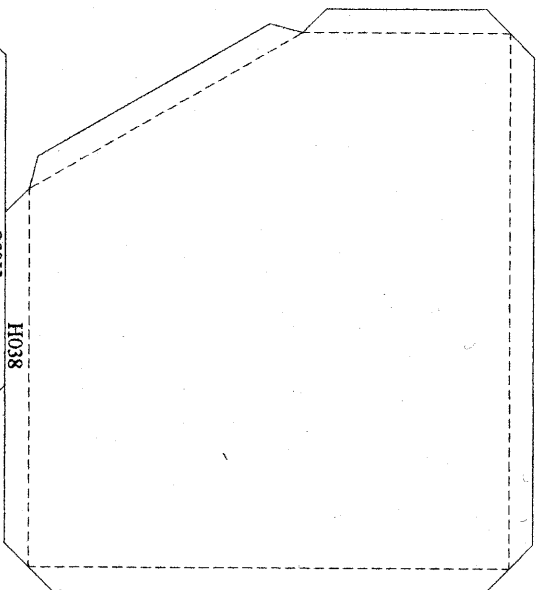

		H022
		H022
		H022

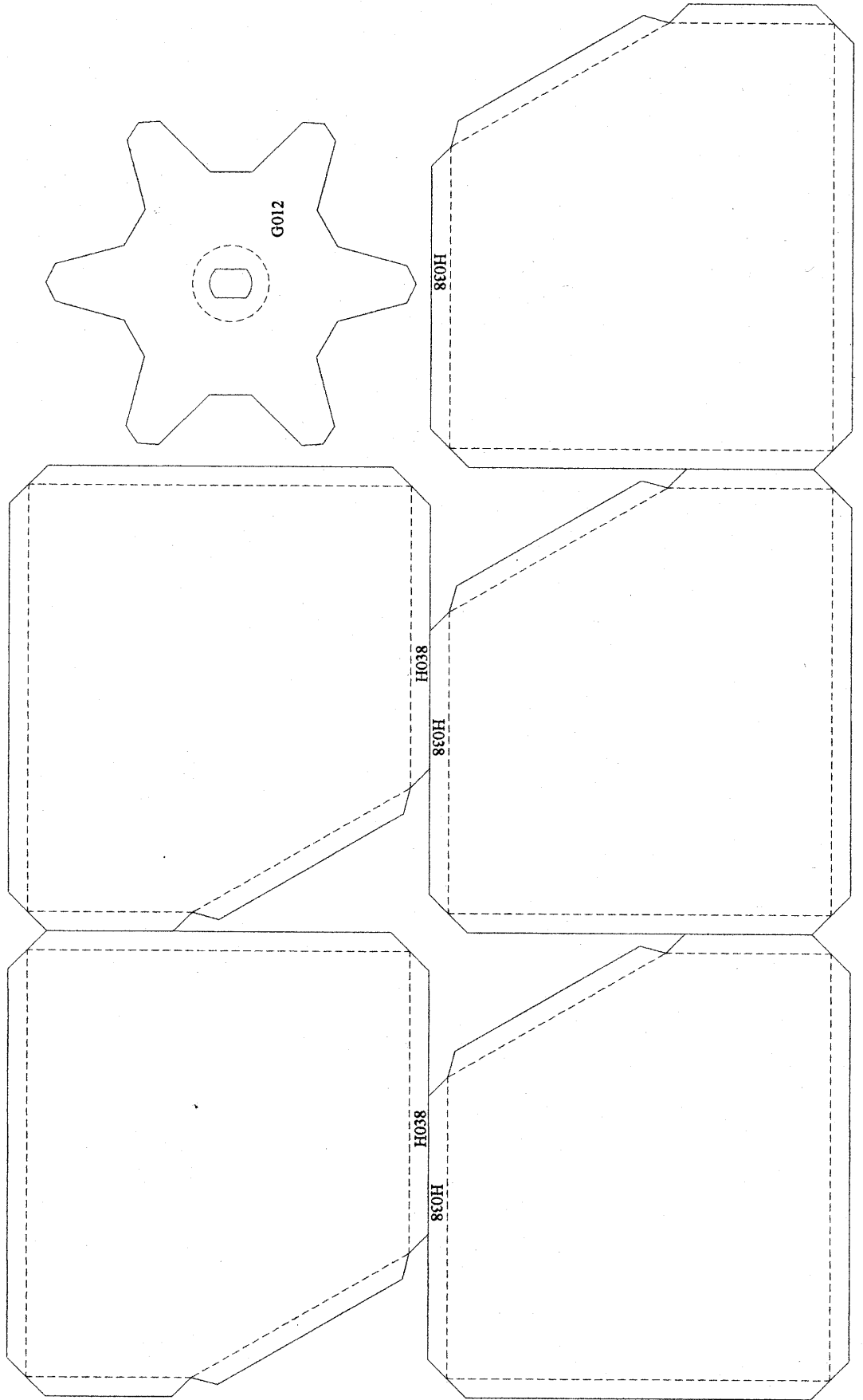
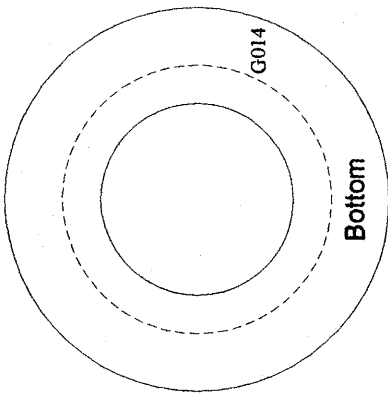

  
CSA05

  
CSA05

  
CSA05

  
CSA05

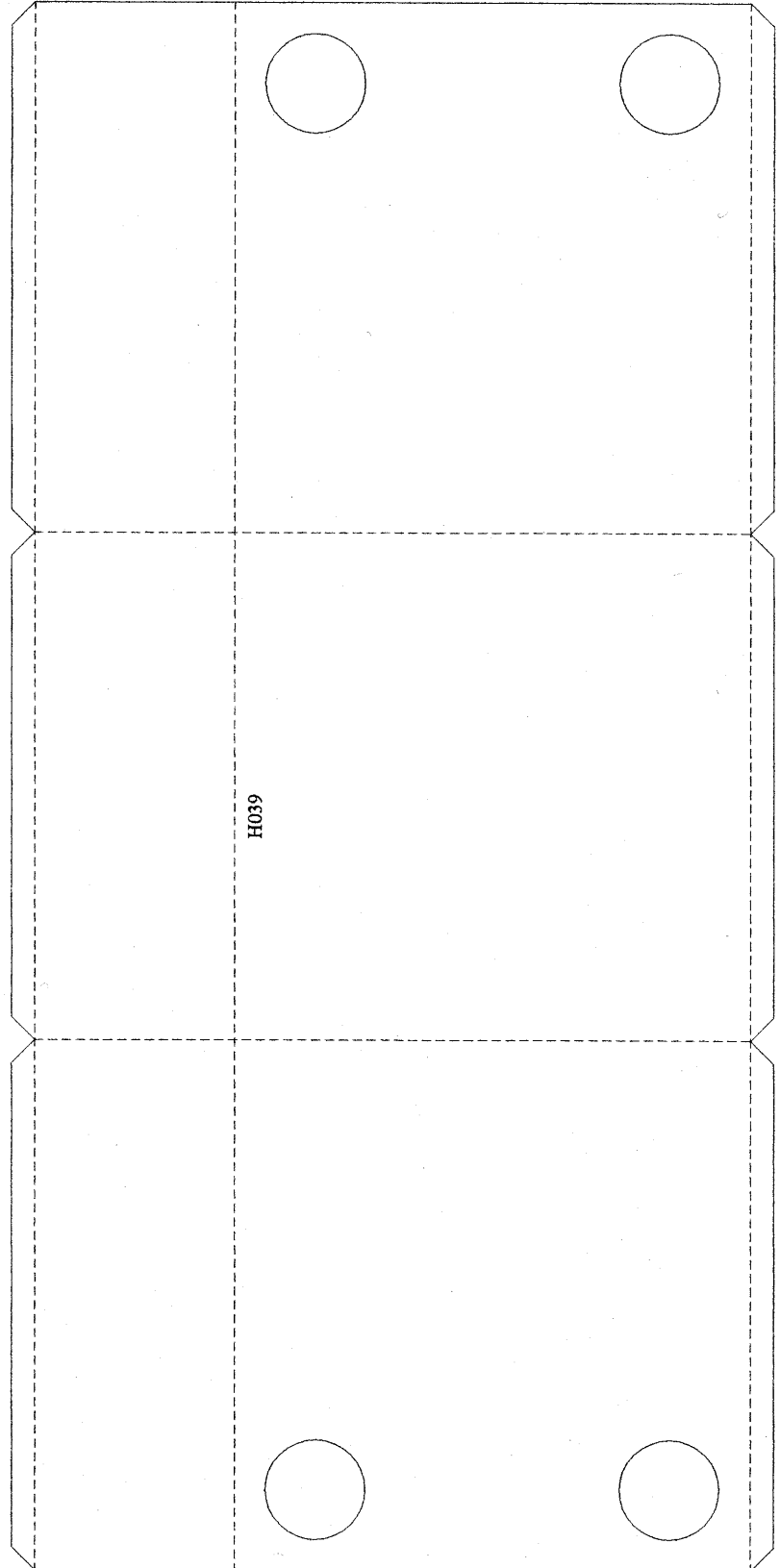
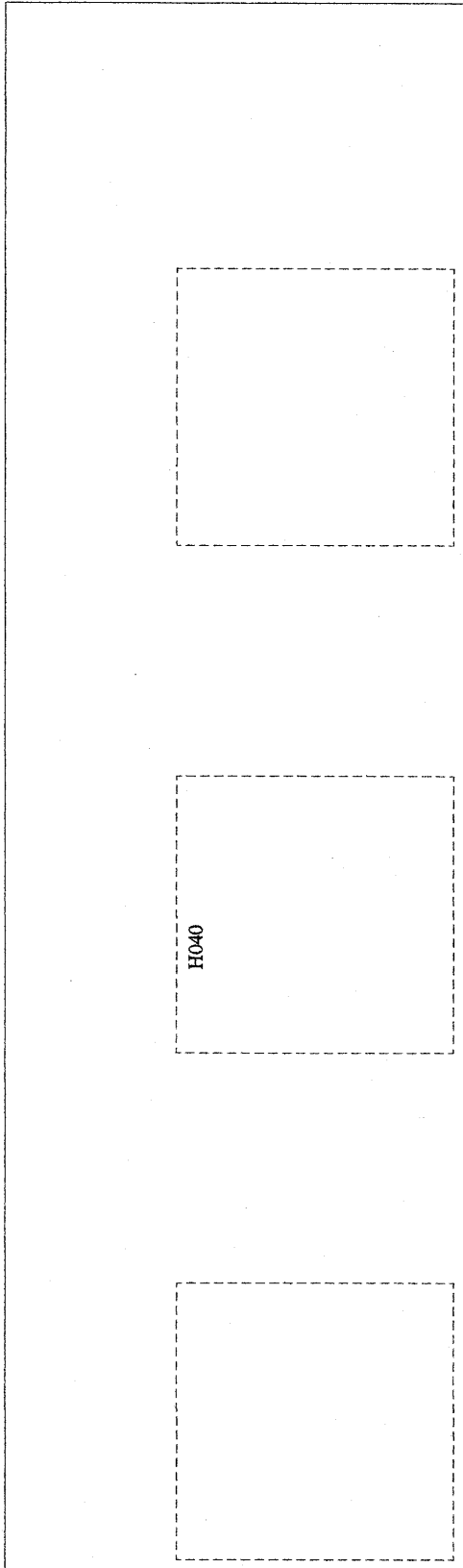

F2 SC027					F3
----------	--	--	--	--	----

	H040	
--	------	--

	H039	
--	------	--

F1	SC026			F2
----	-------	--	--	----

	H040		

		H039	

10	G042a
02	G042b
03	G042c
04	G042d
05	G042e
06	G042f
07	G042g
08	G042h
09	G042i
10	G042j
11	G042k
12	G042l



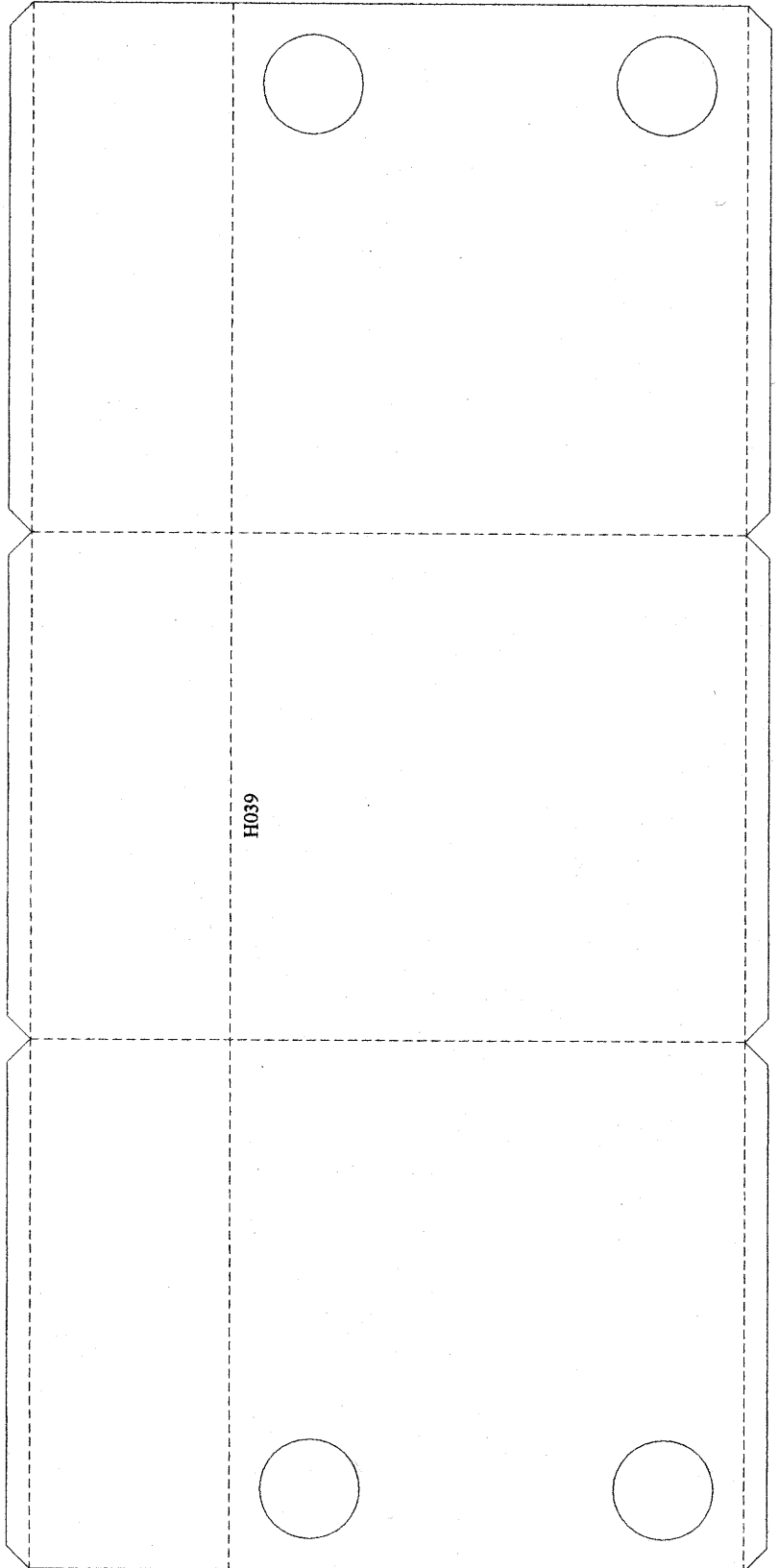
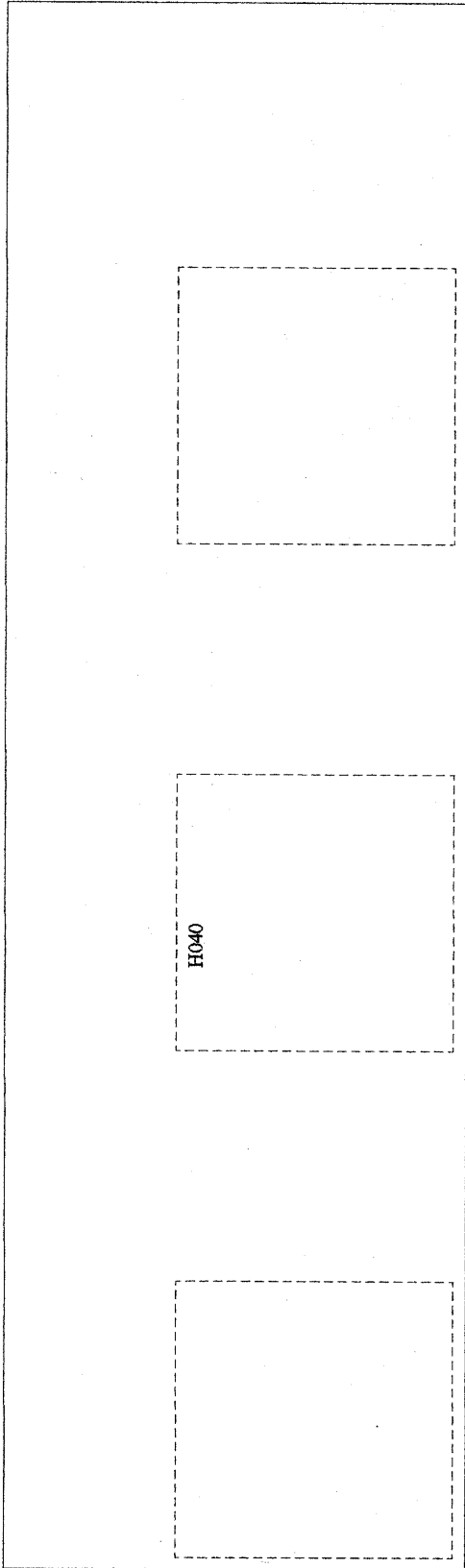
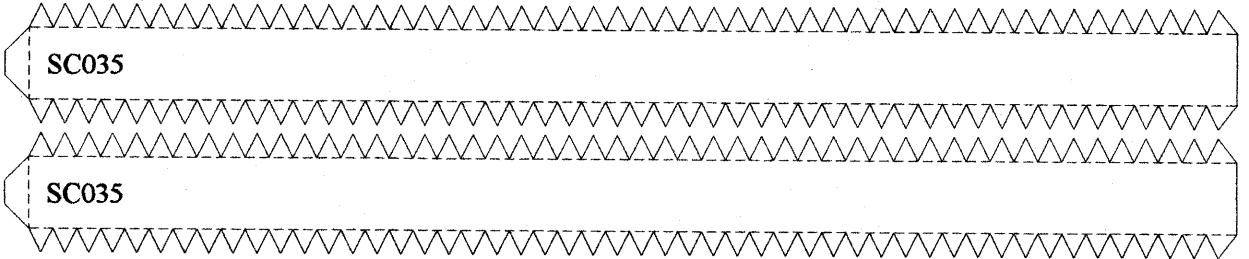
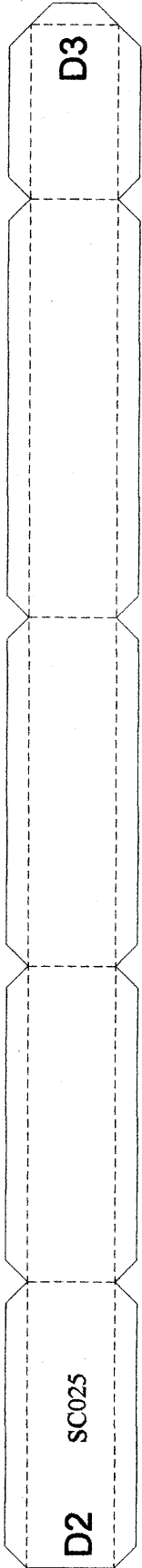

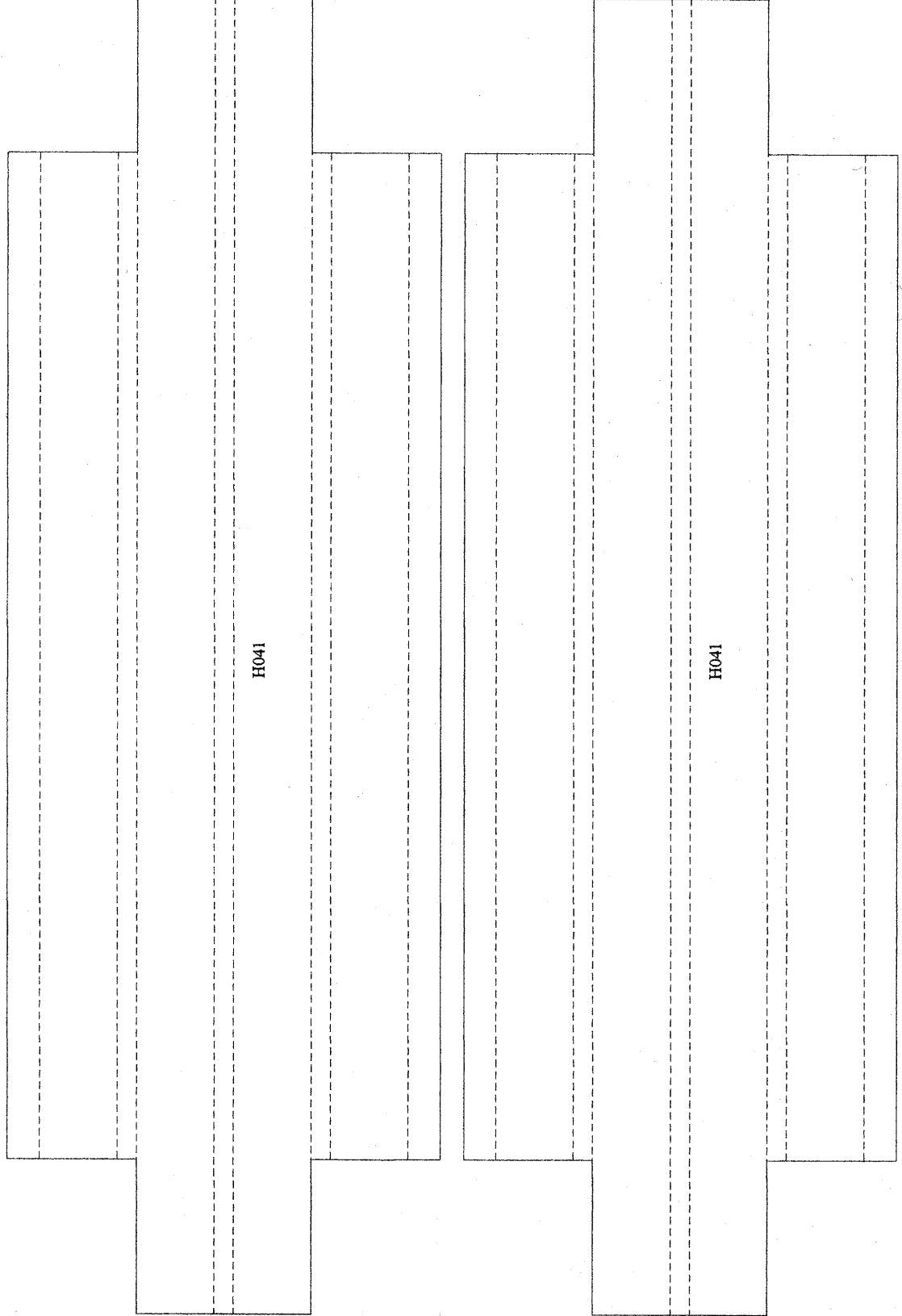
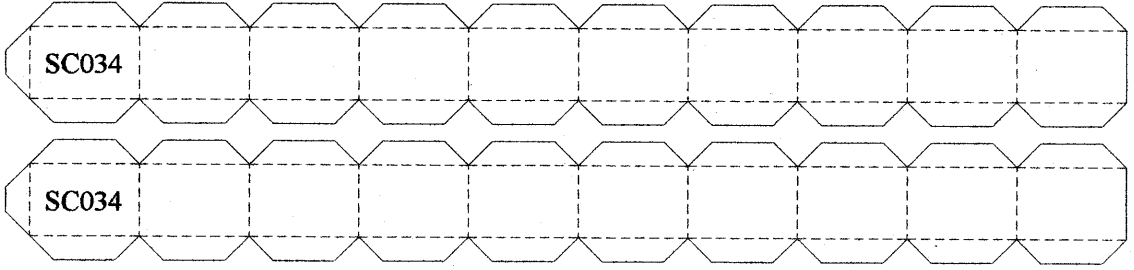
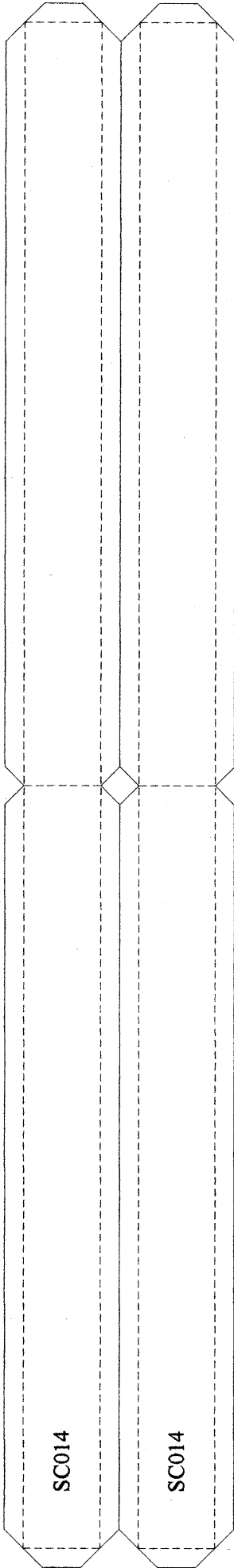

H022
H022
H022
H022
H022

H020
H020
H020
H020
H020
H020
H020
H020
H020
H020

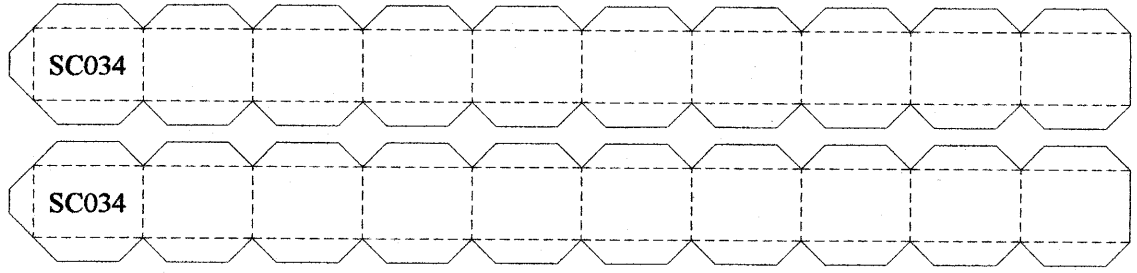
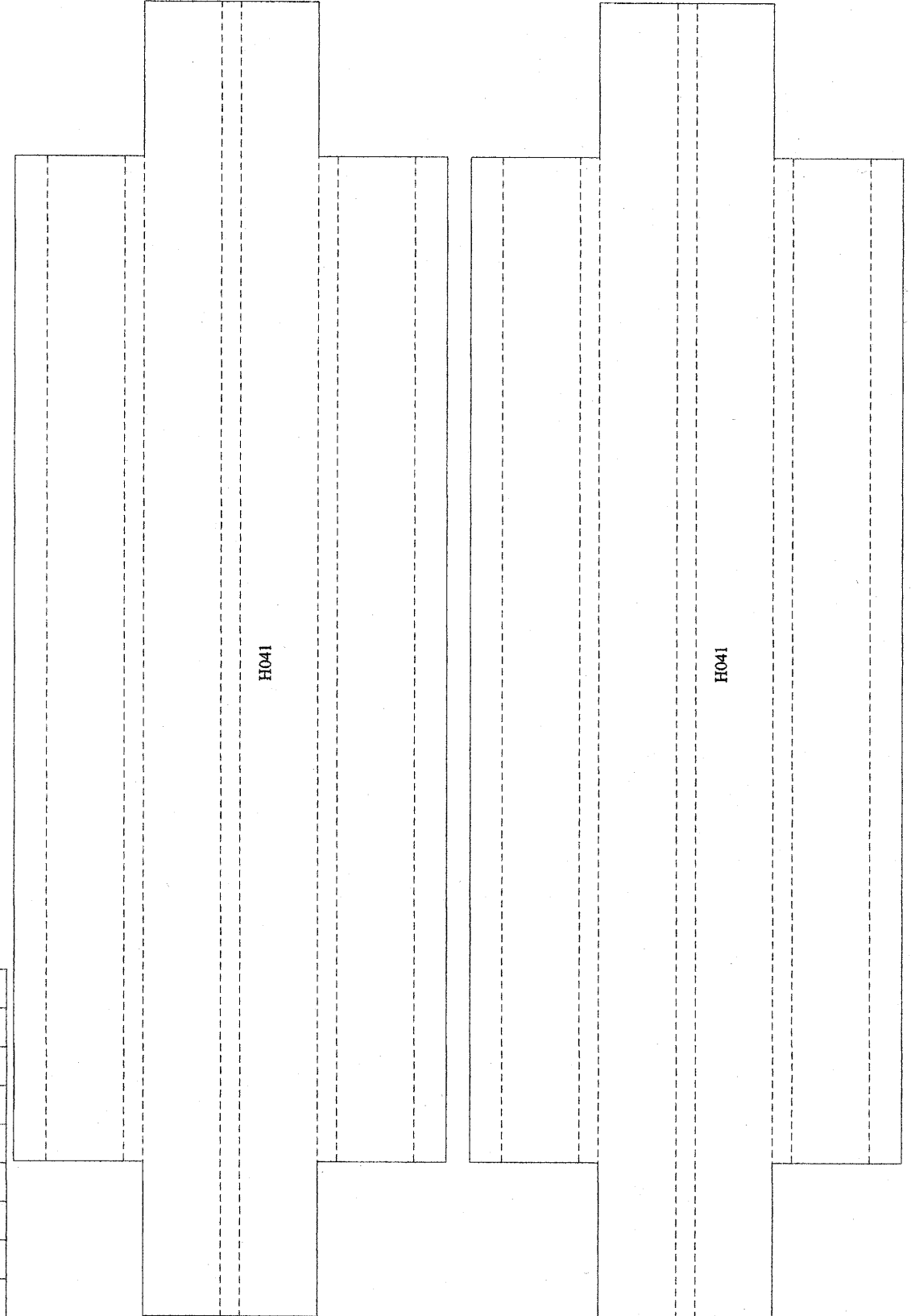

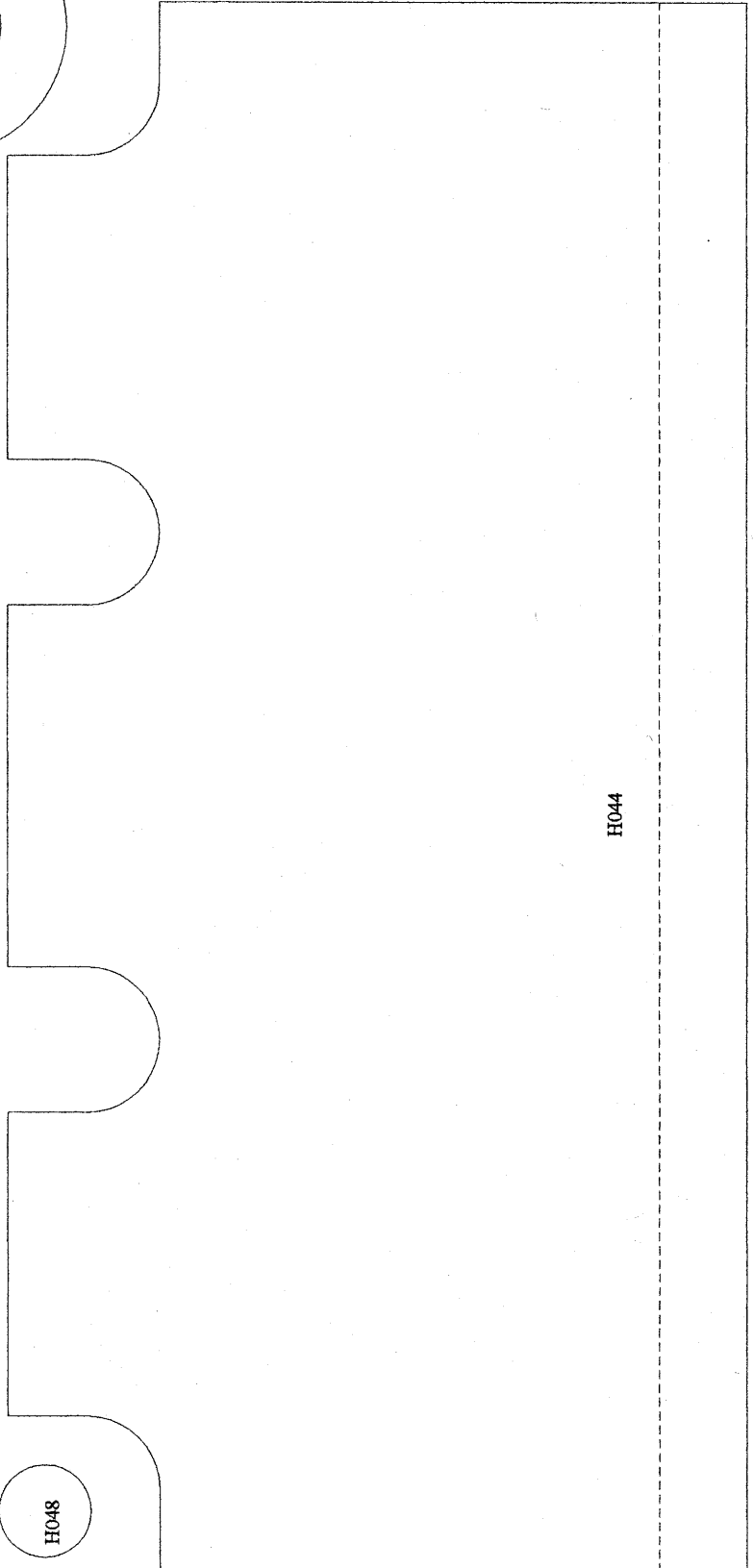
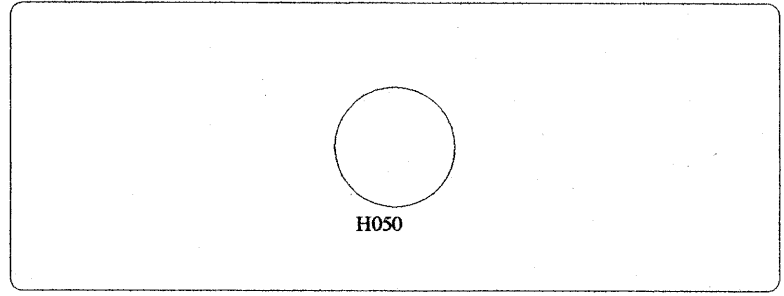
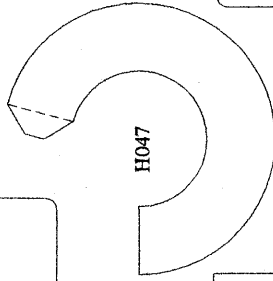
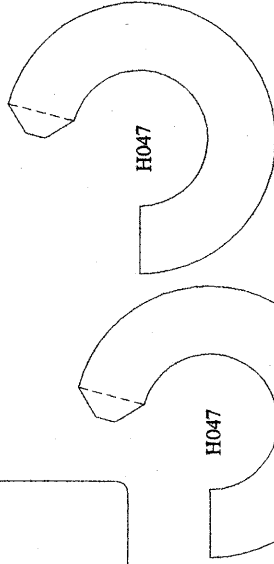
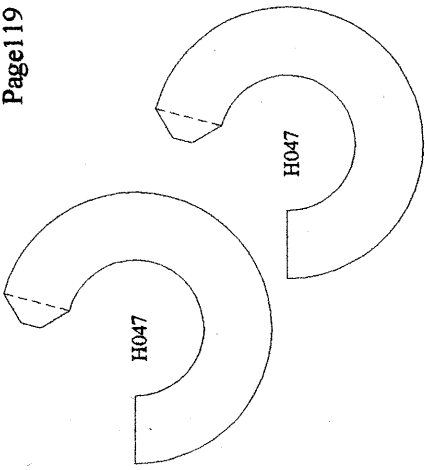
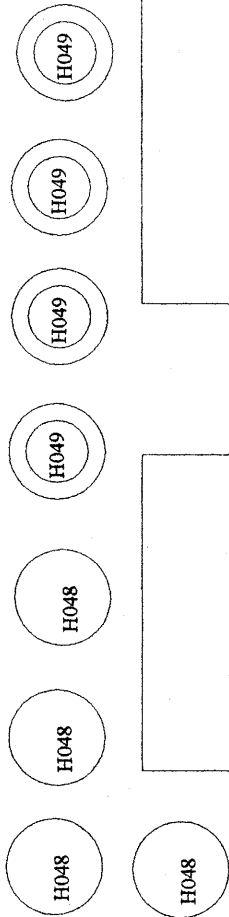
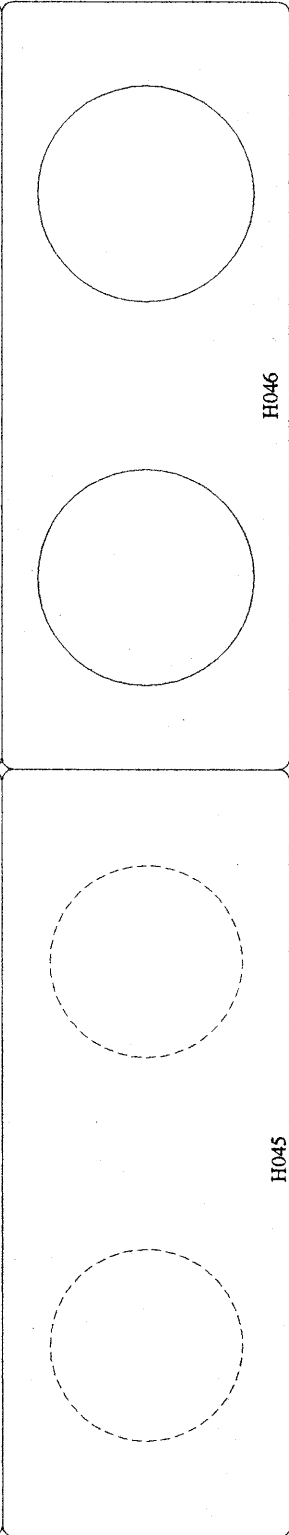
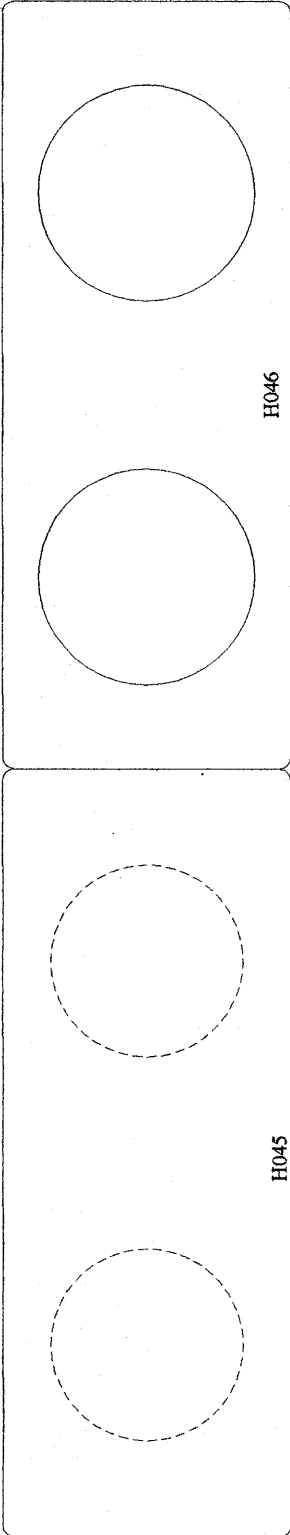

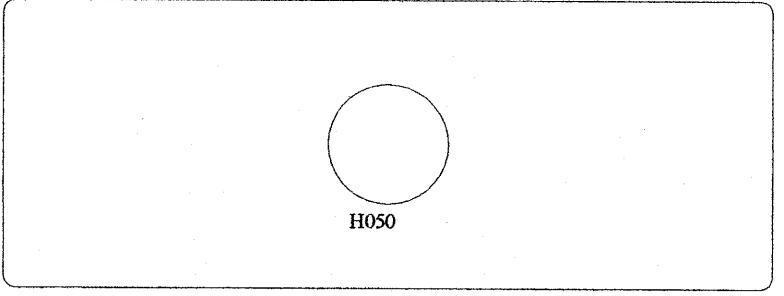
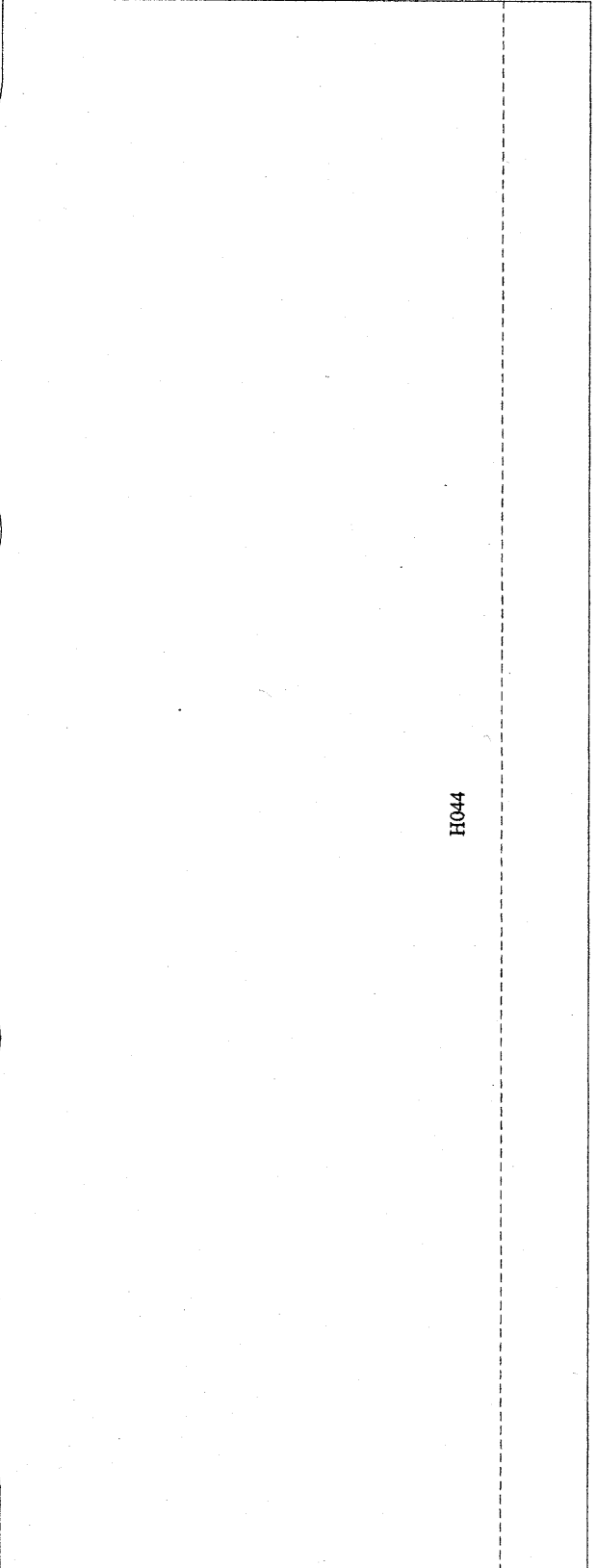
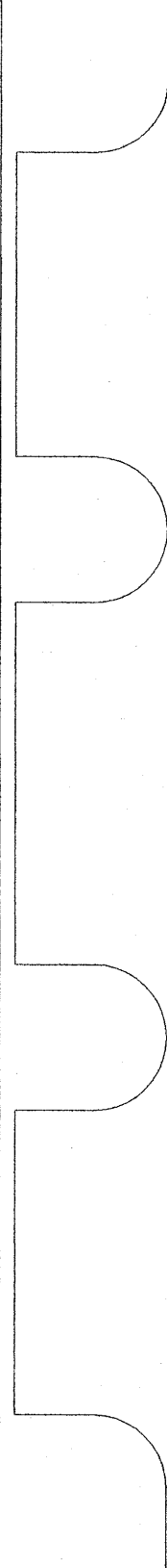
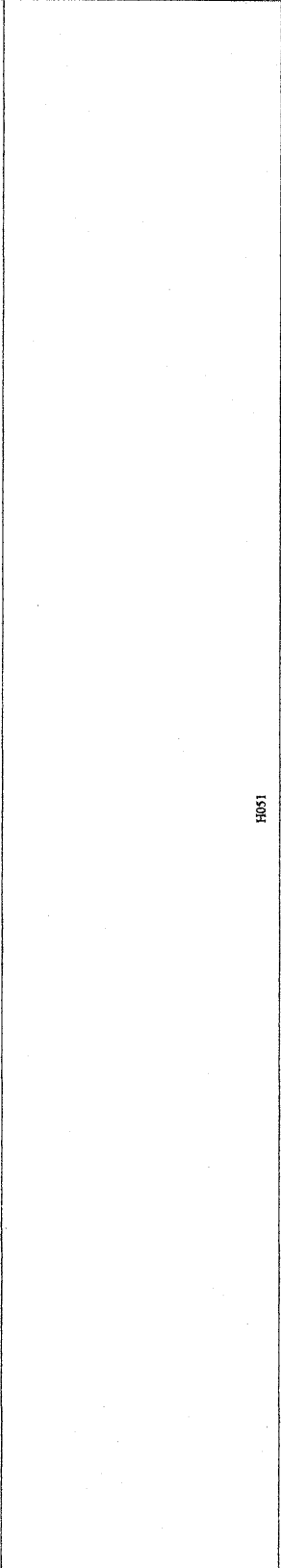
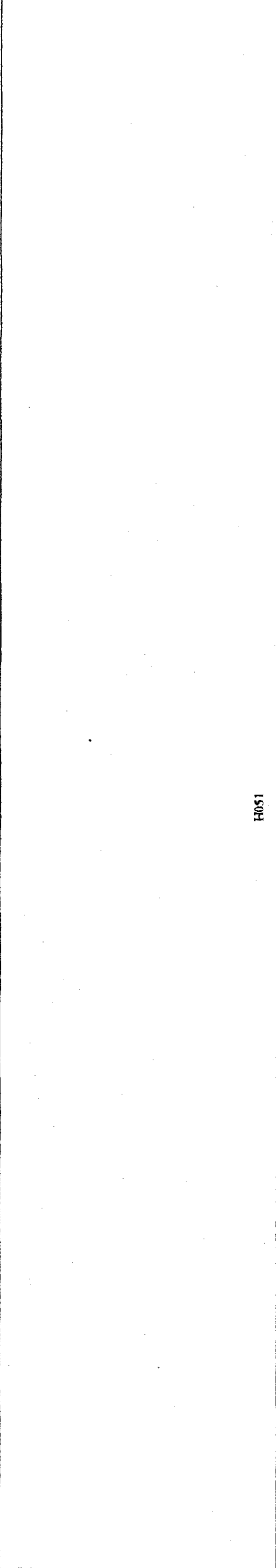
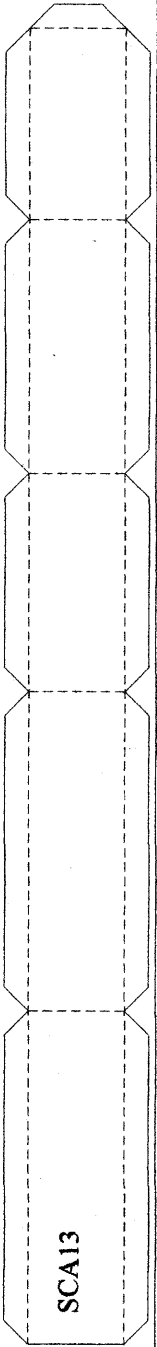

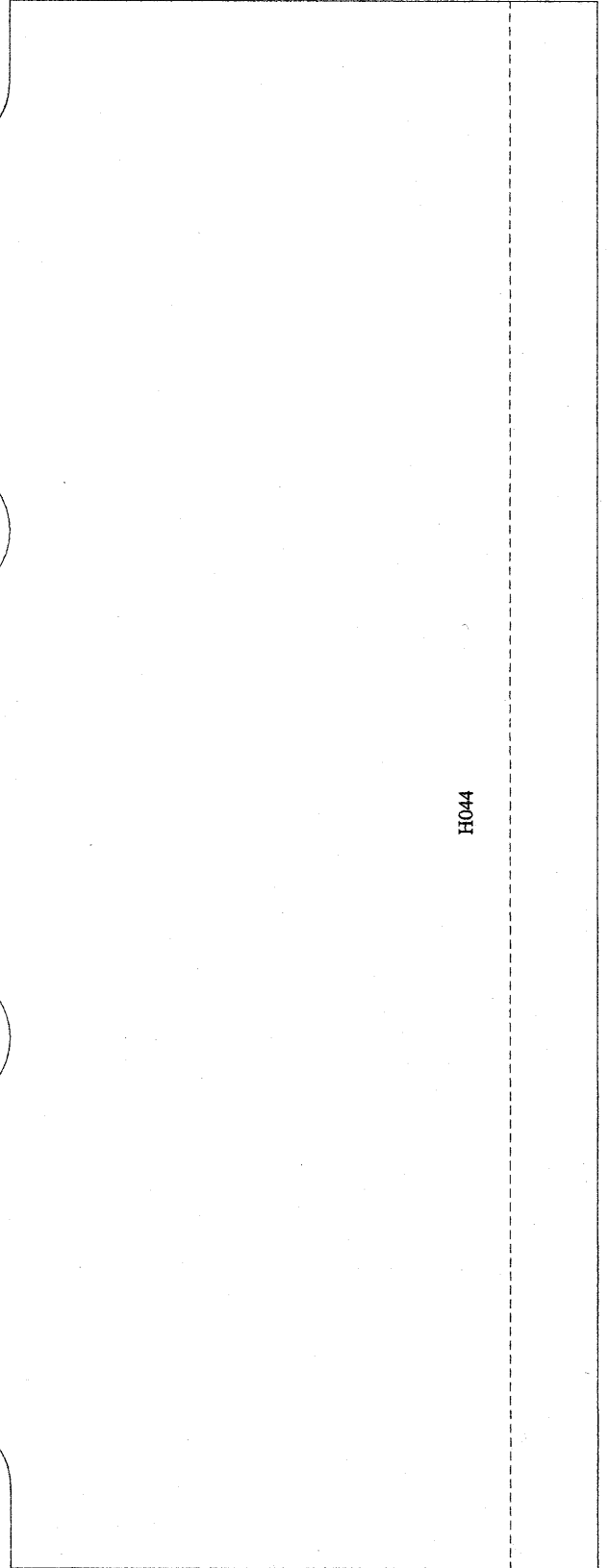
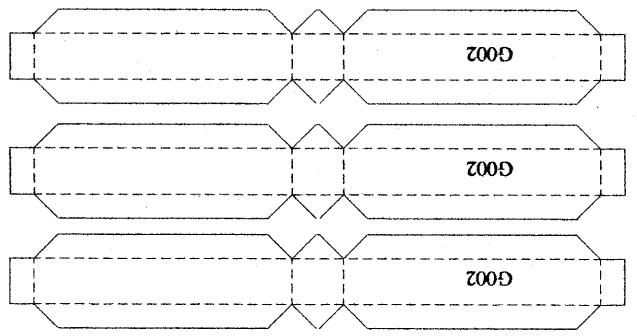
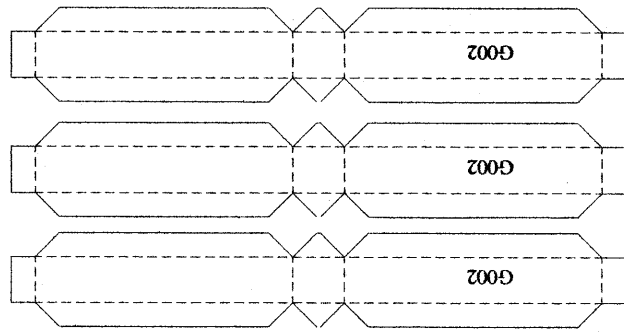
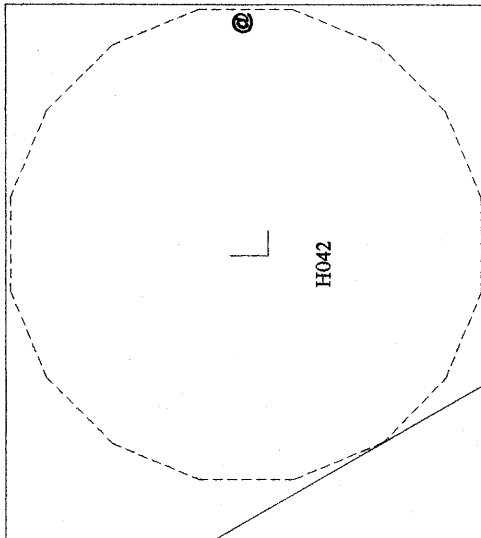
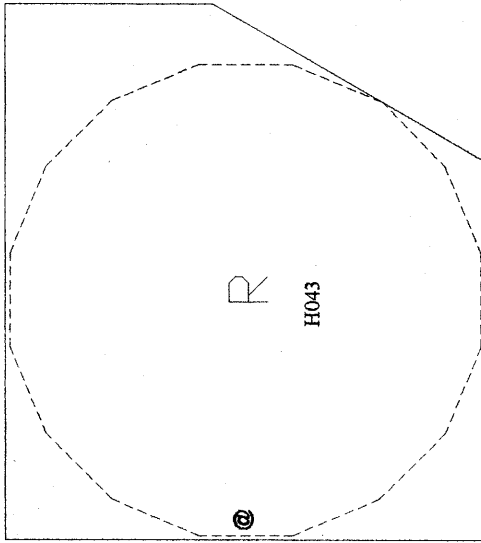
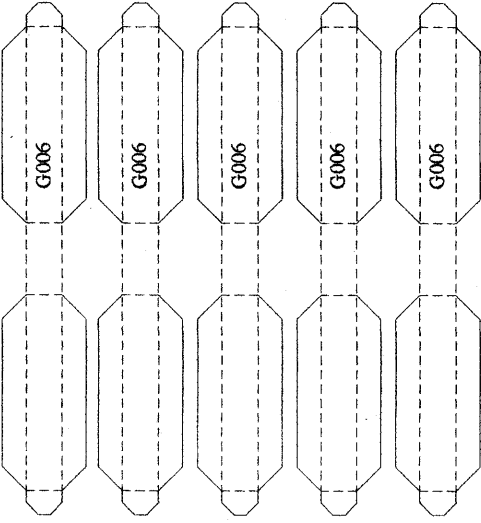
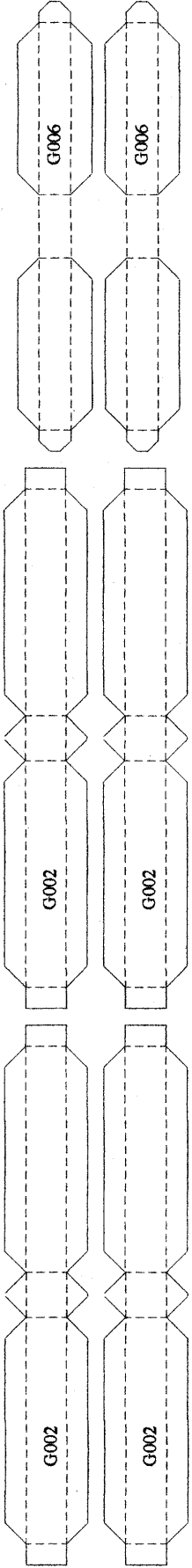

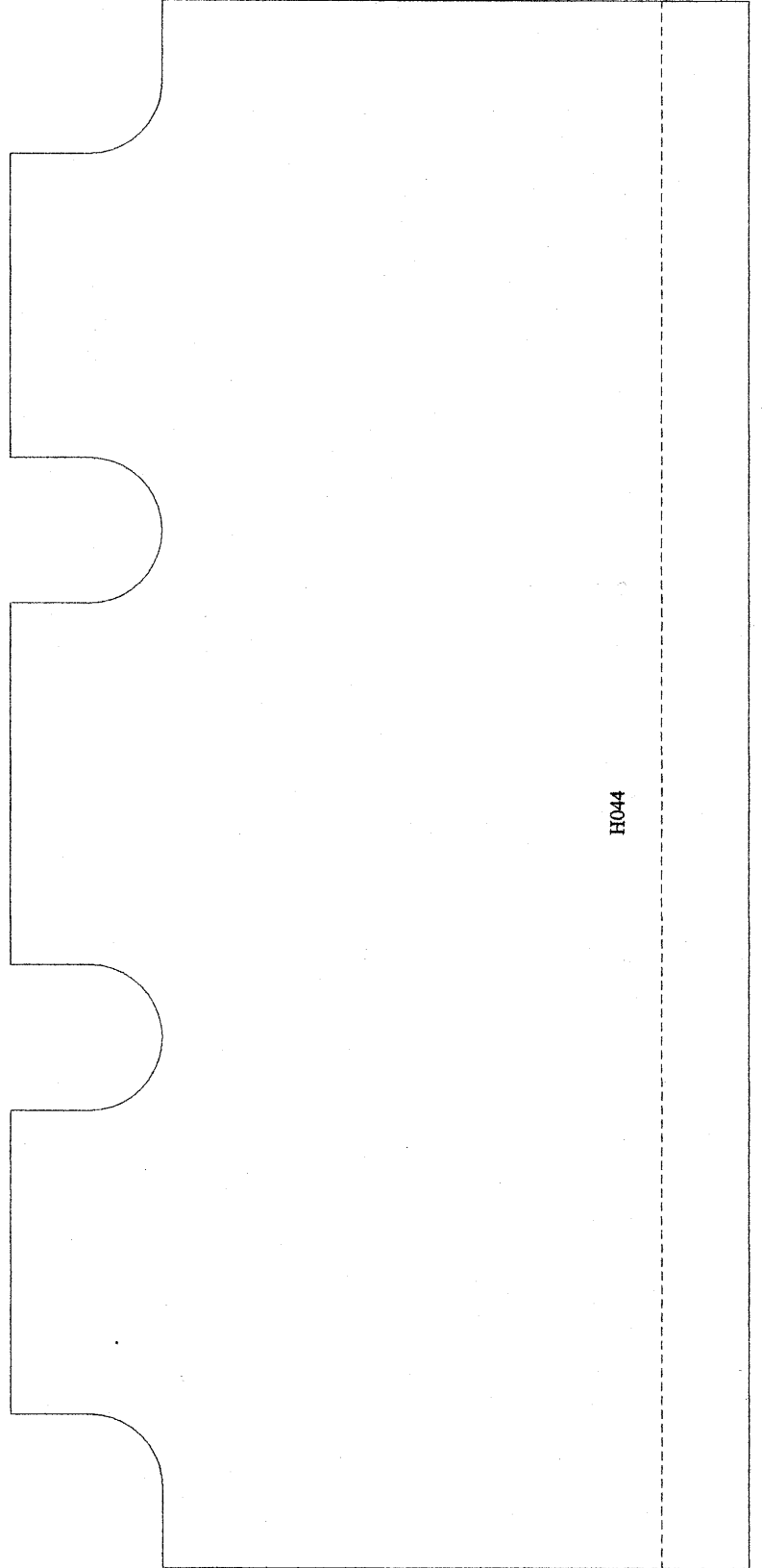
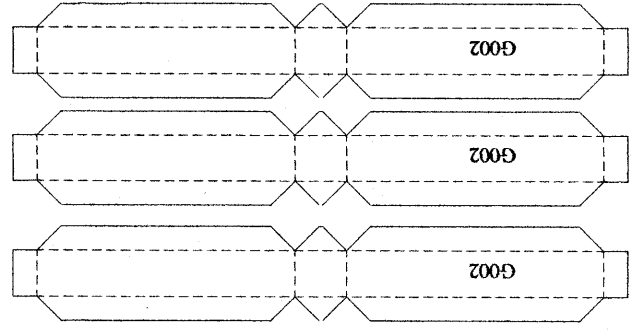
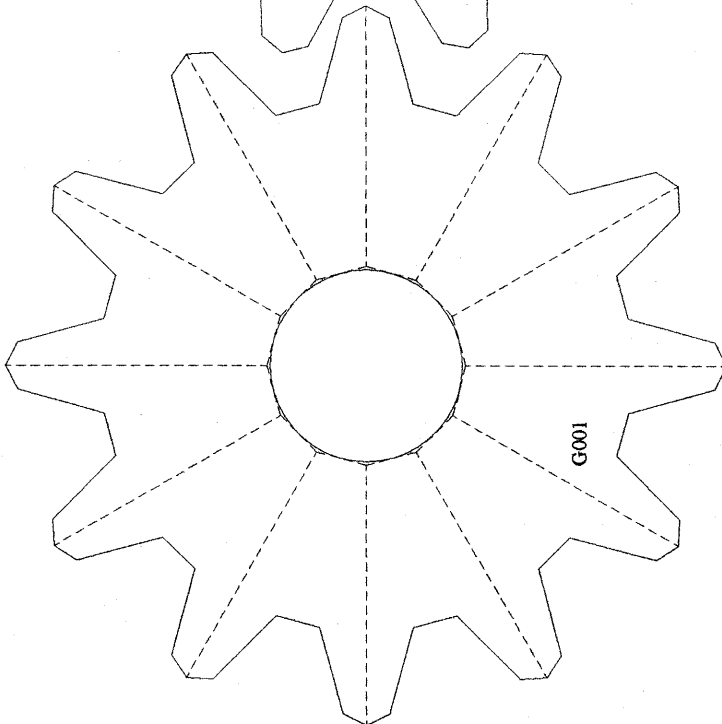
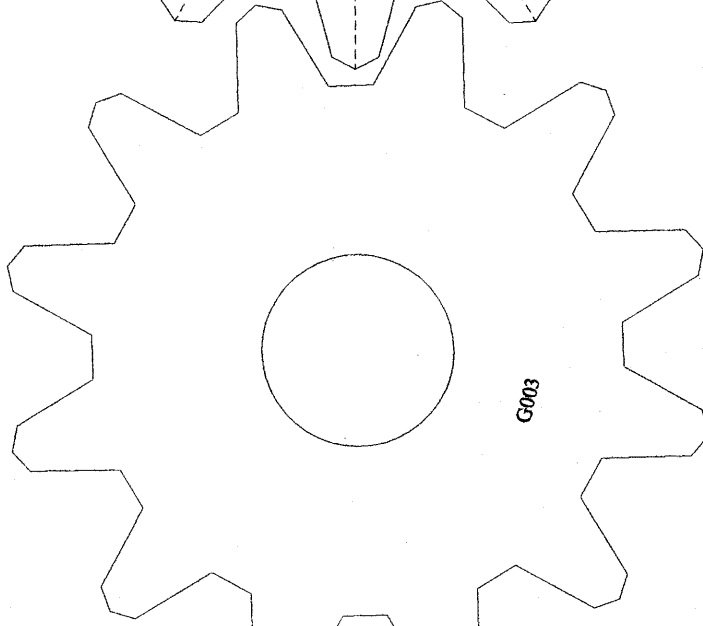
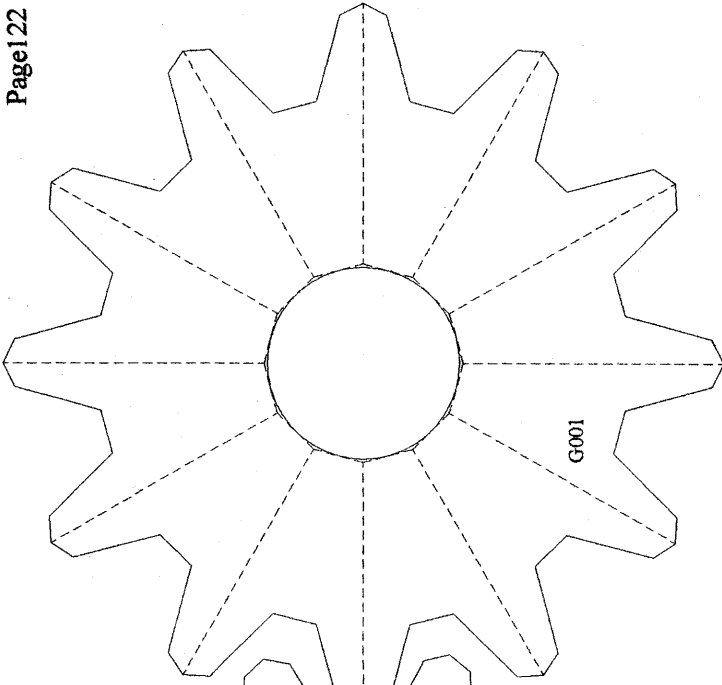

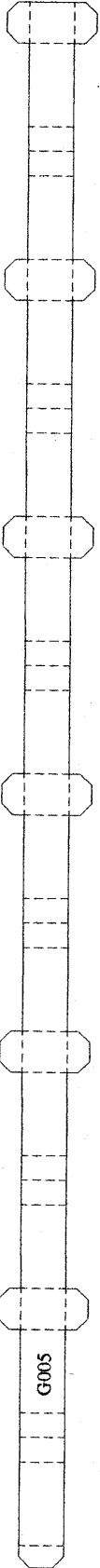
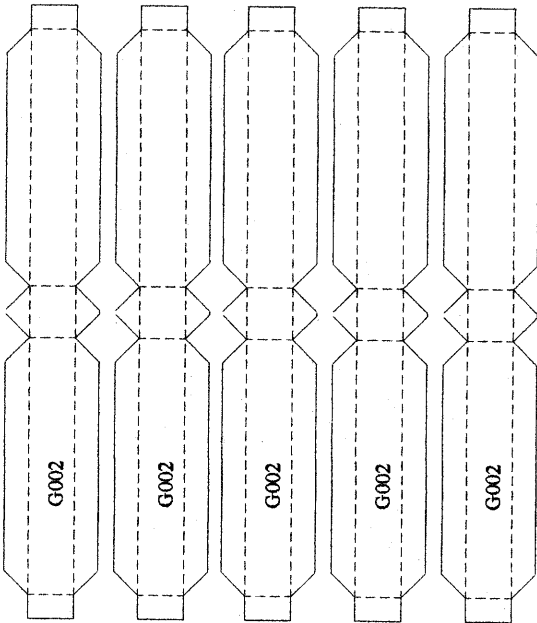
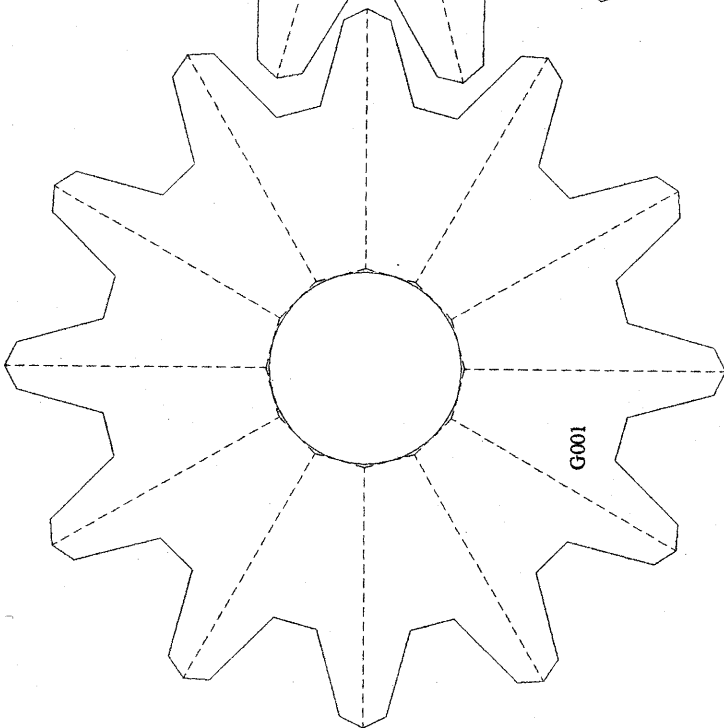
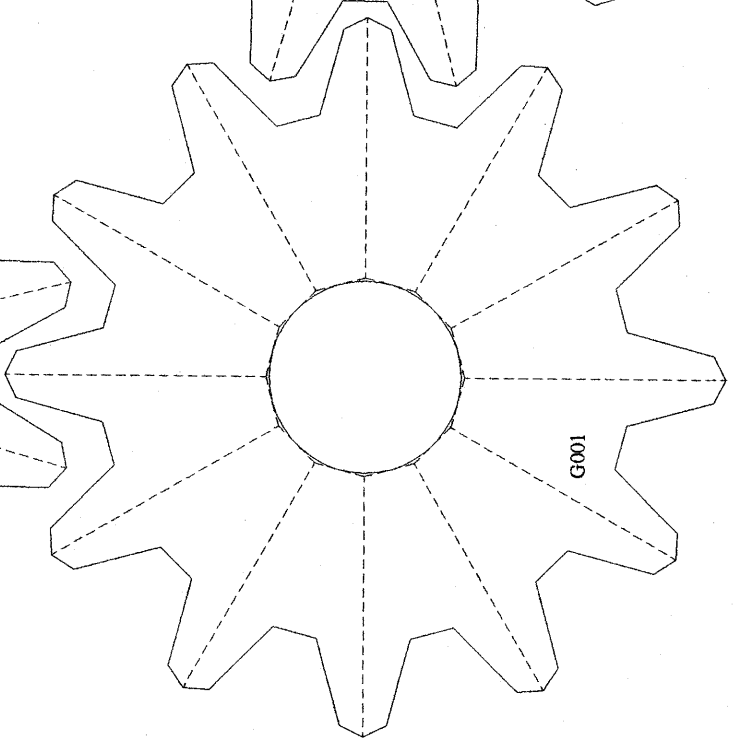
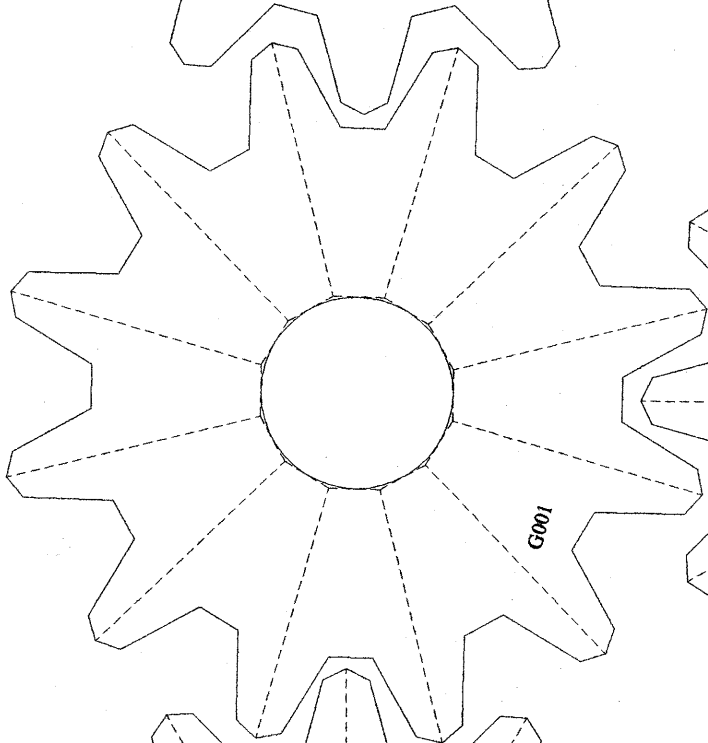
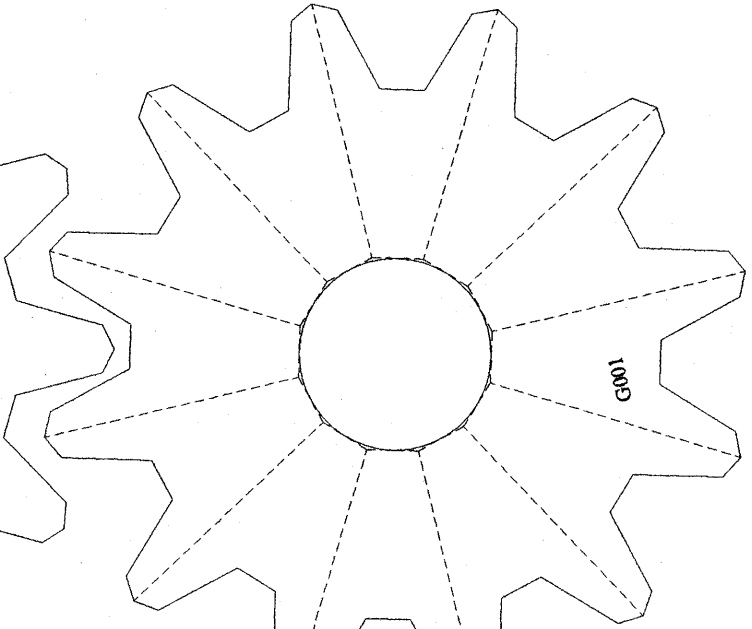
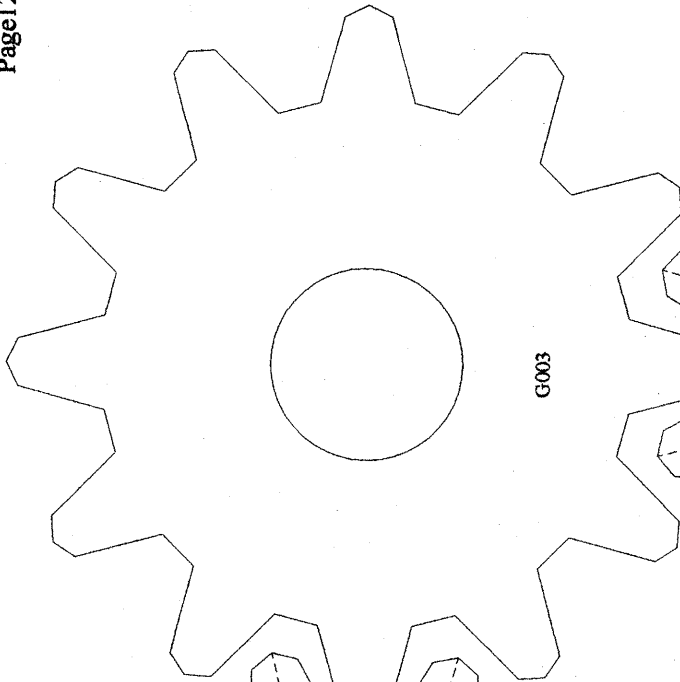



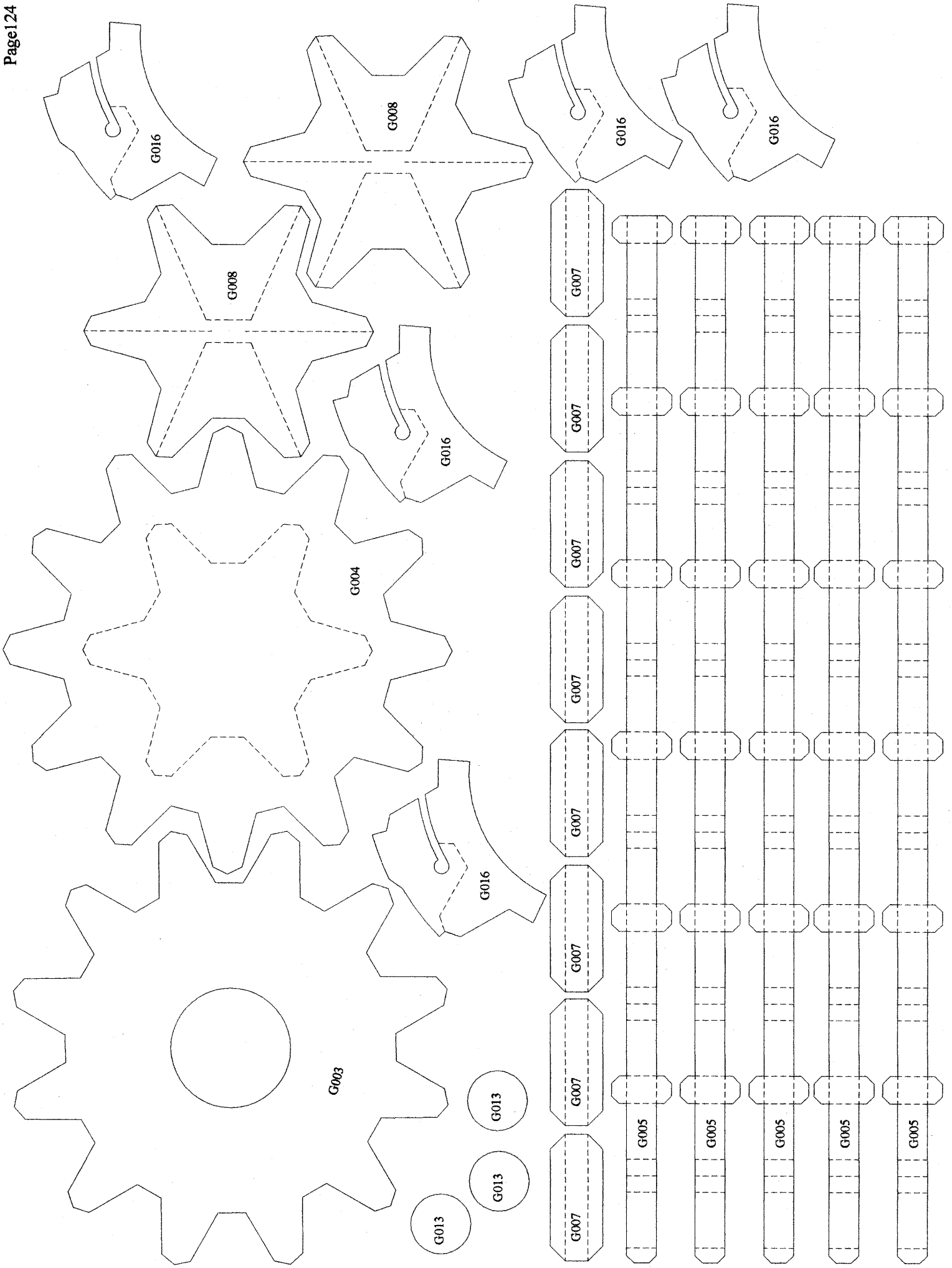

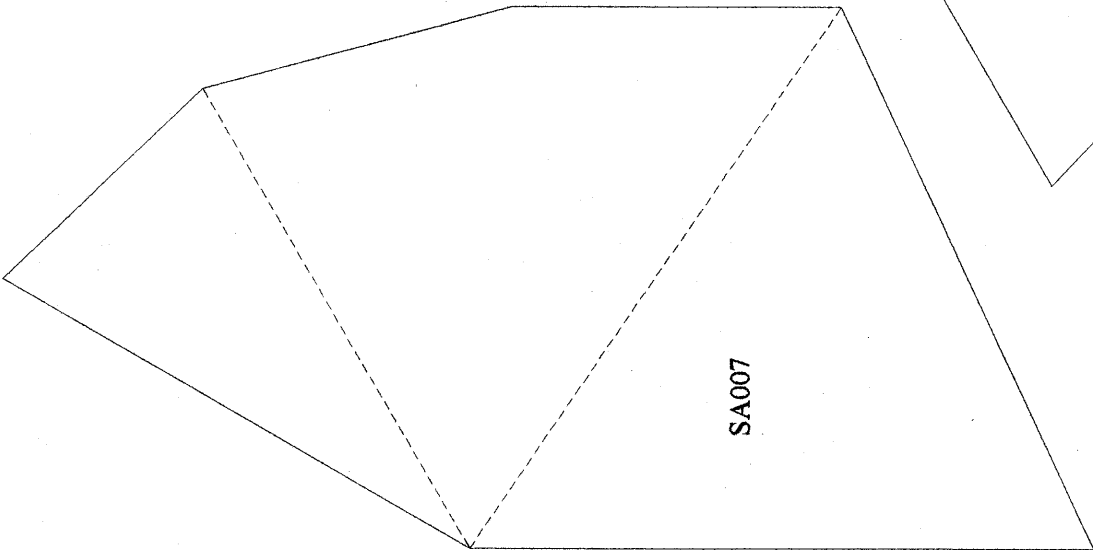
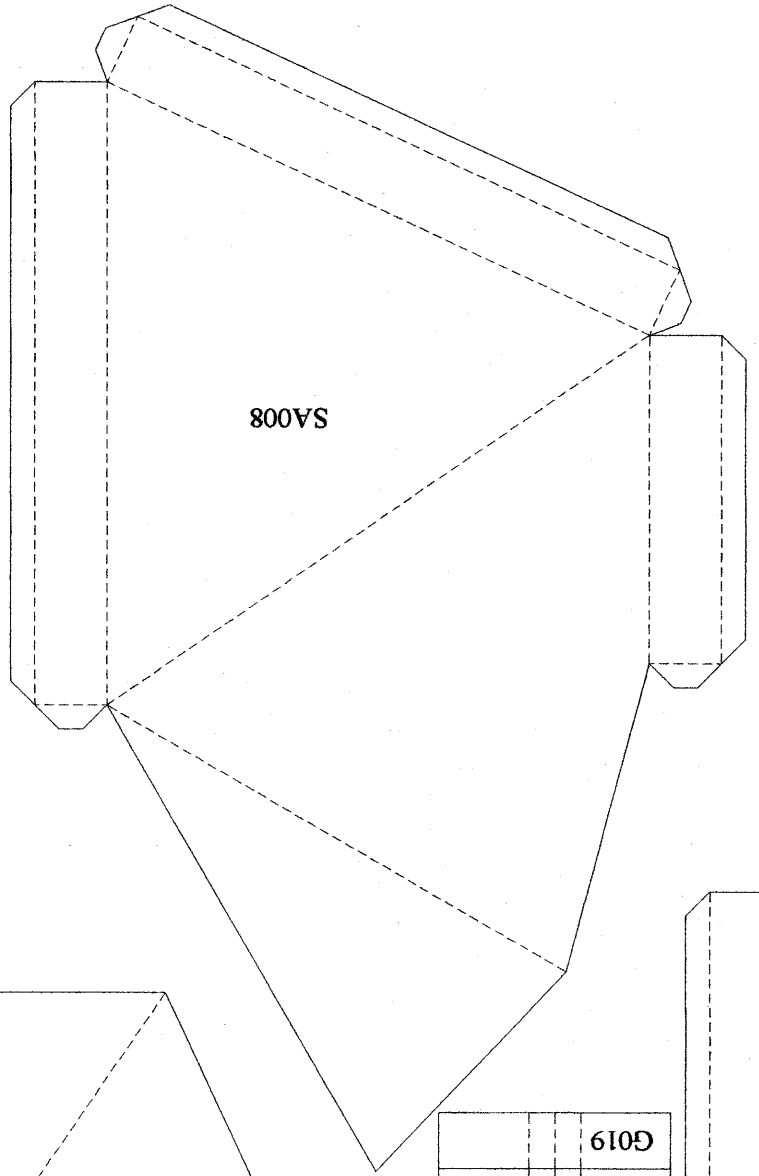
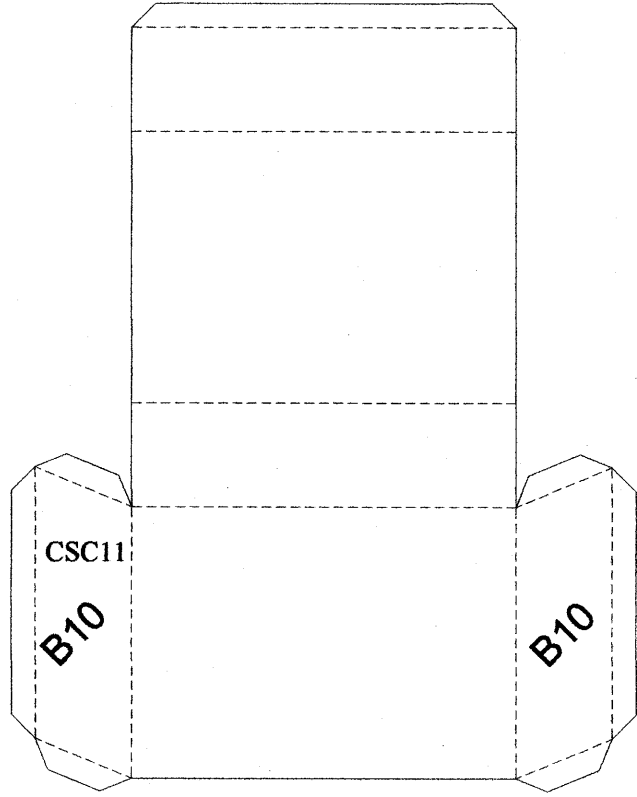

G018	G018	G018	G018	G018	G018	G018	G018	G018	G018	G018	G018
------	------	------	------	------	------	------	------	------	------	------	------

G017	G017	G017	G017	G017	G017	G017	G017	G017	G017	G017	G017	G017
------	------	------	------	------	------	------	------	------	------	------	------	------

G019	G019	G019	G019	G019	G019	G019	G019	G019	G019	G019	G019
------	------	------	------	------	------	------	------	------	------	------	------

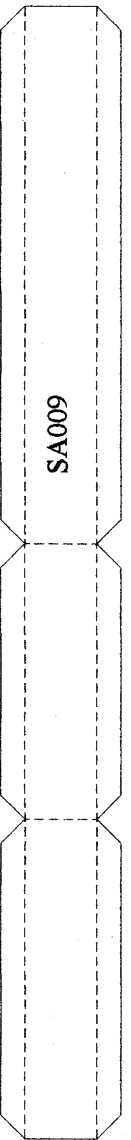

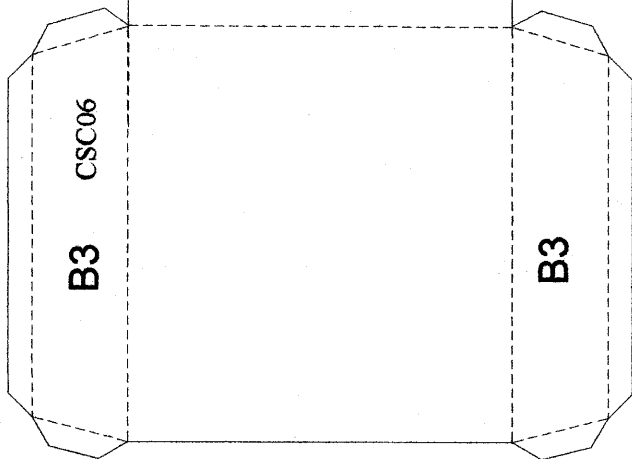
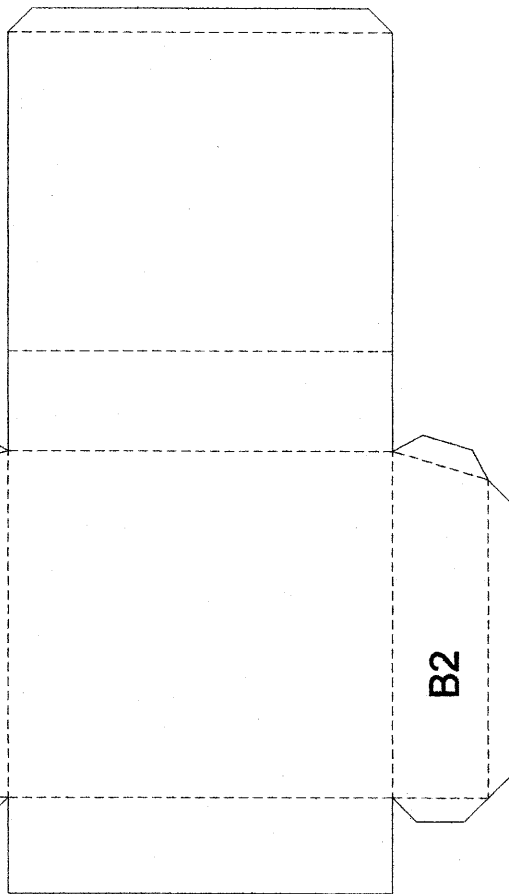
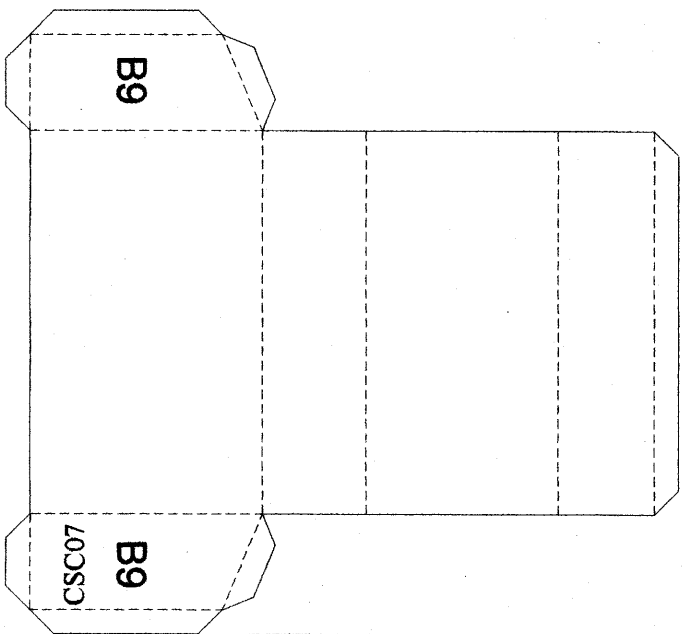
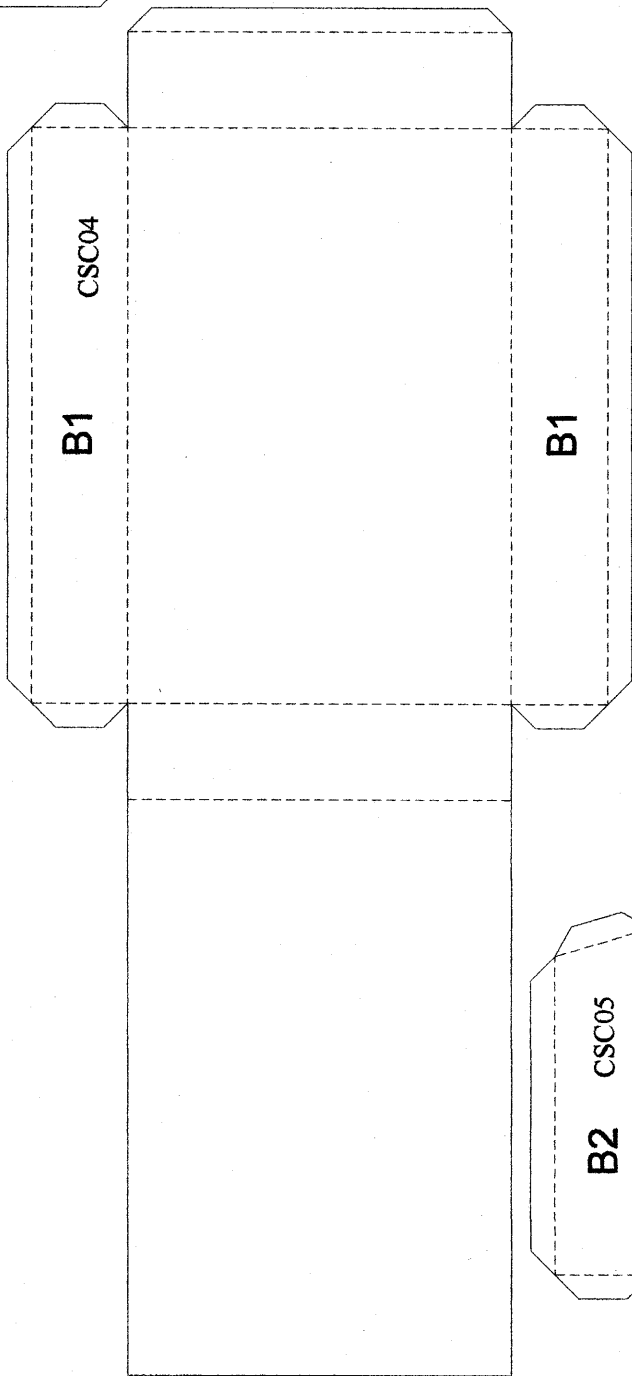
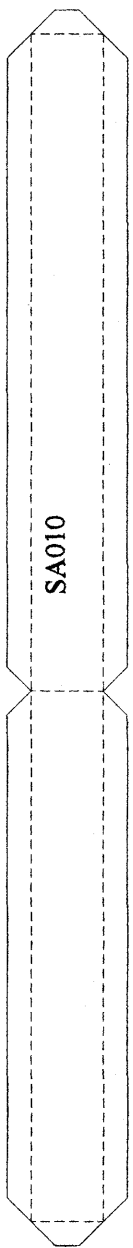

	H022
	H022
	H022
	H022

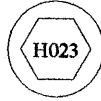
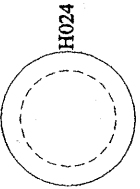
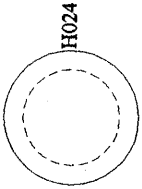
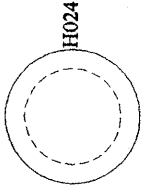
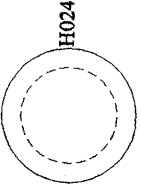

H021	H021	H021	H021	H021	H021	H021	H021	H021	H021

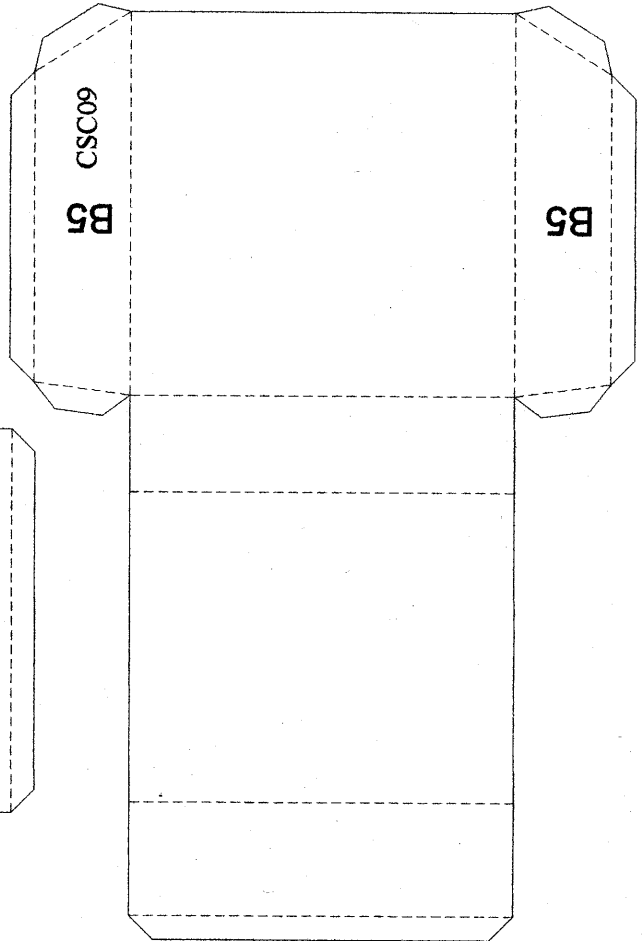
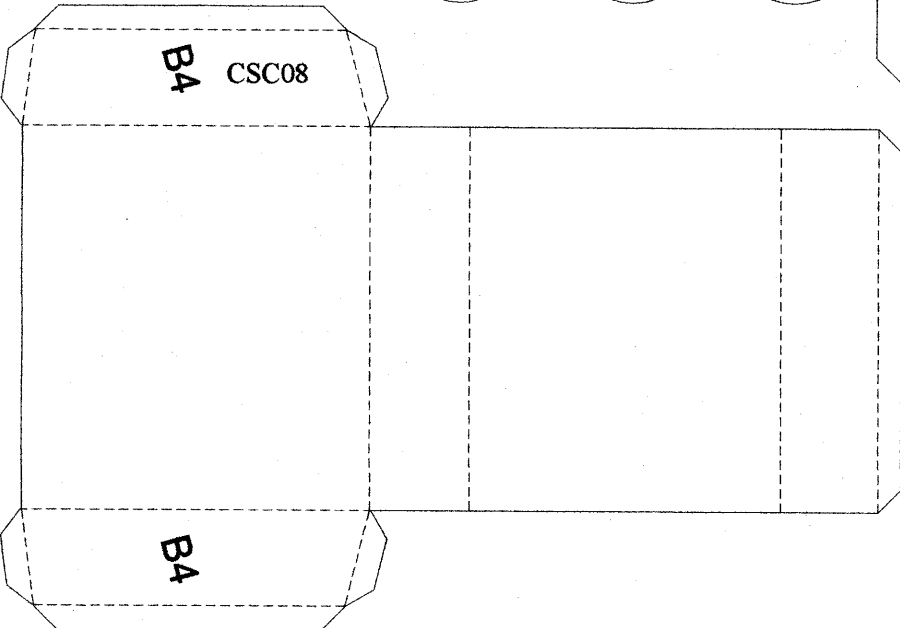
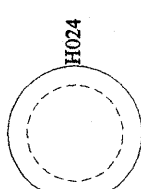
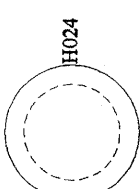
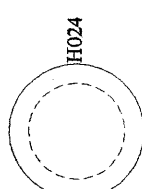
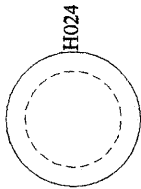
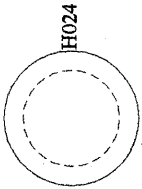
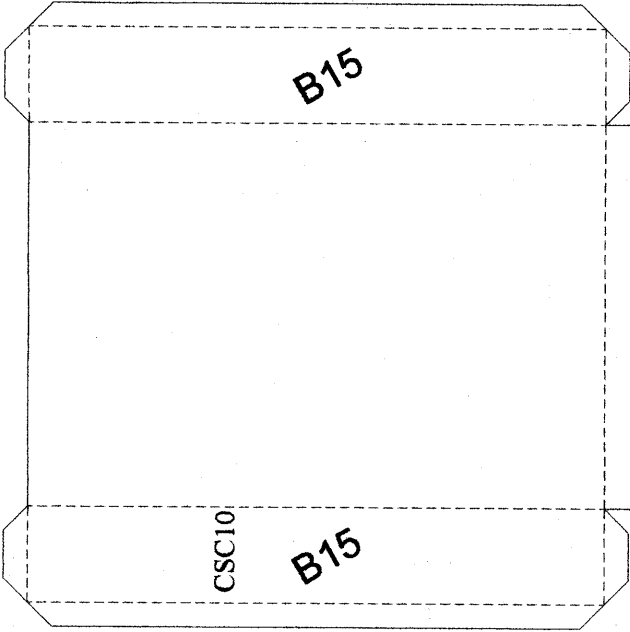

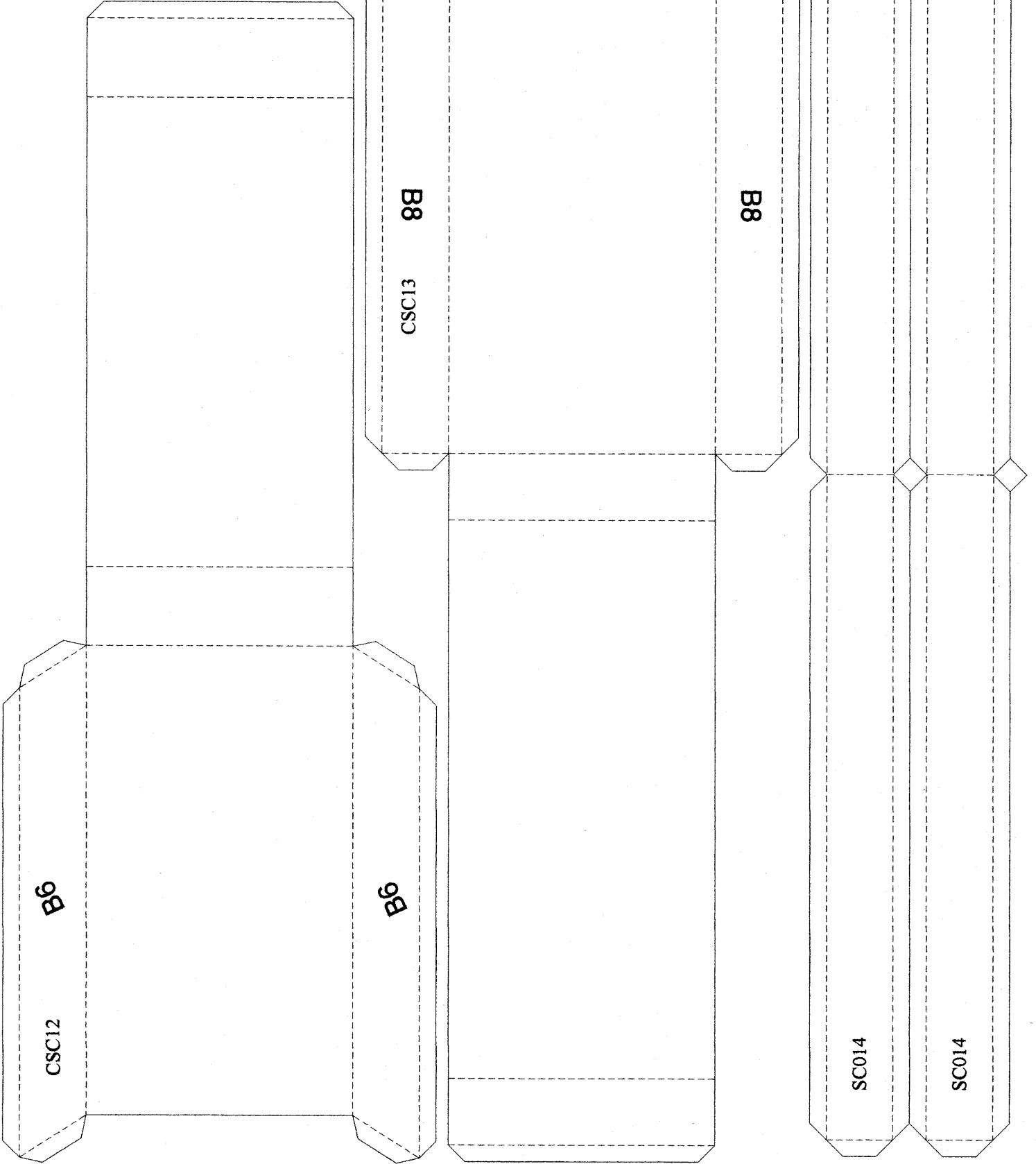

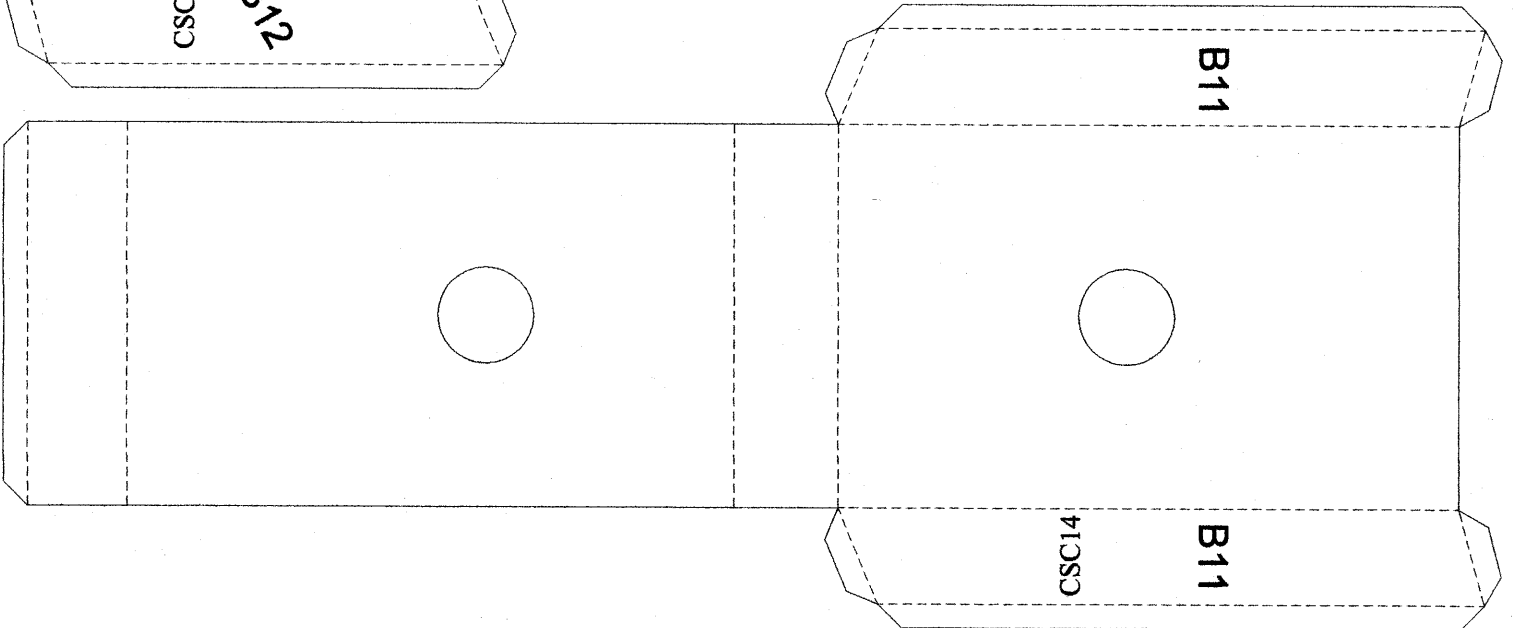
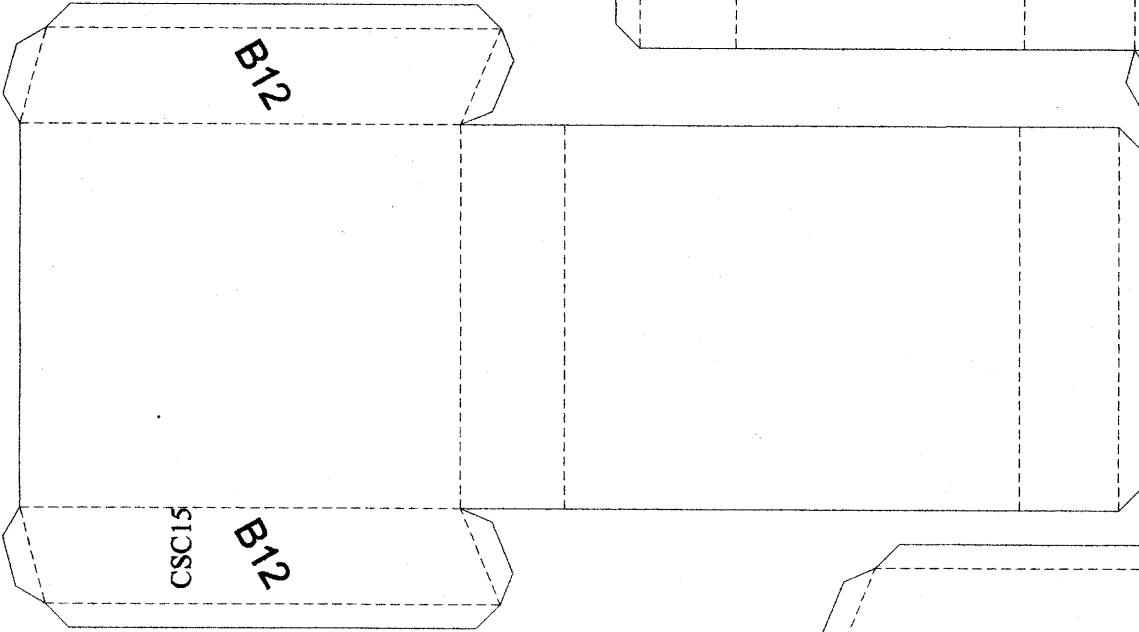
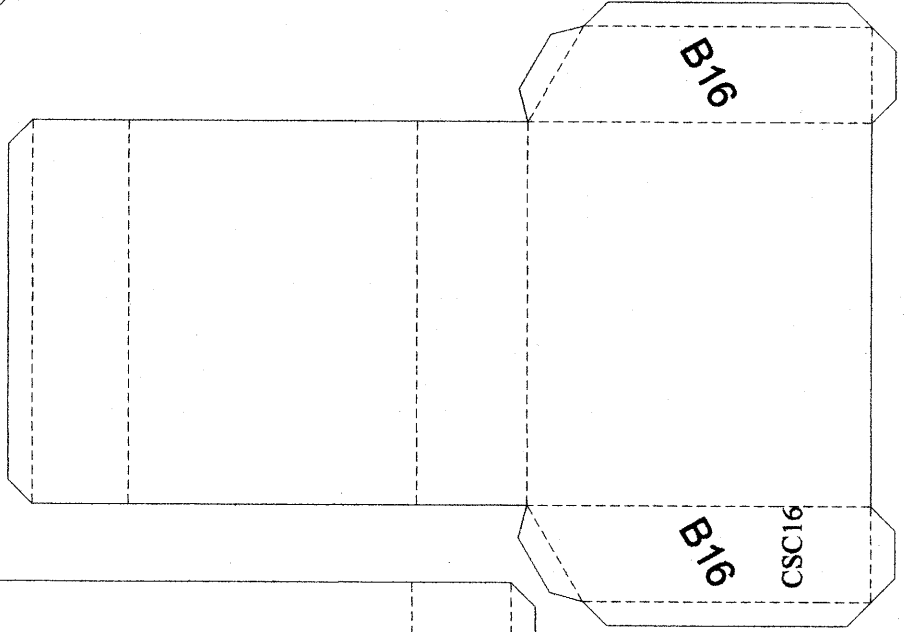
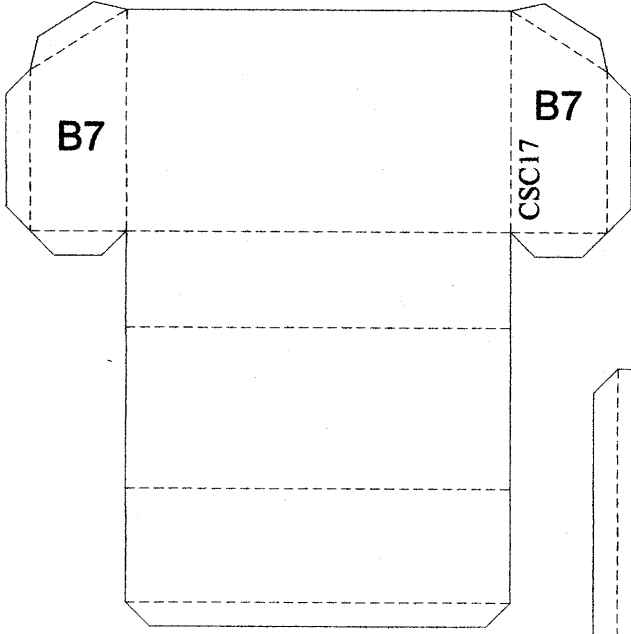

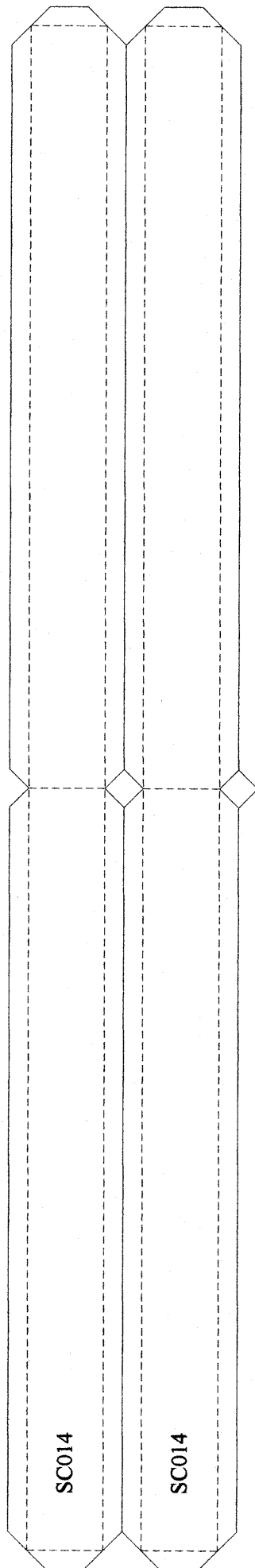
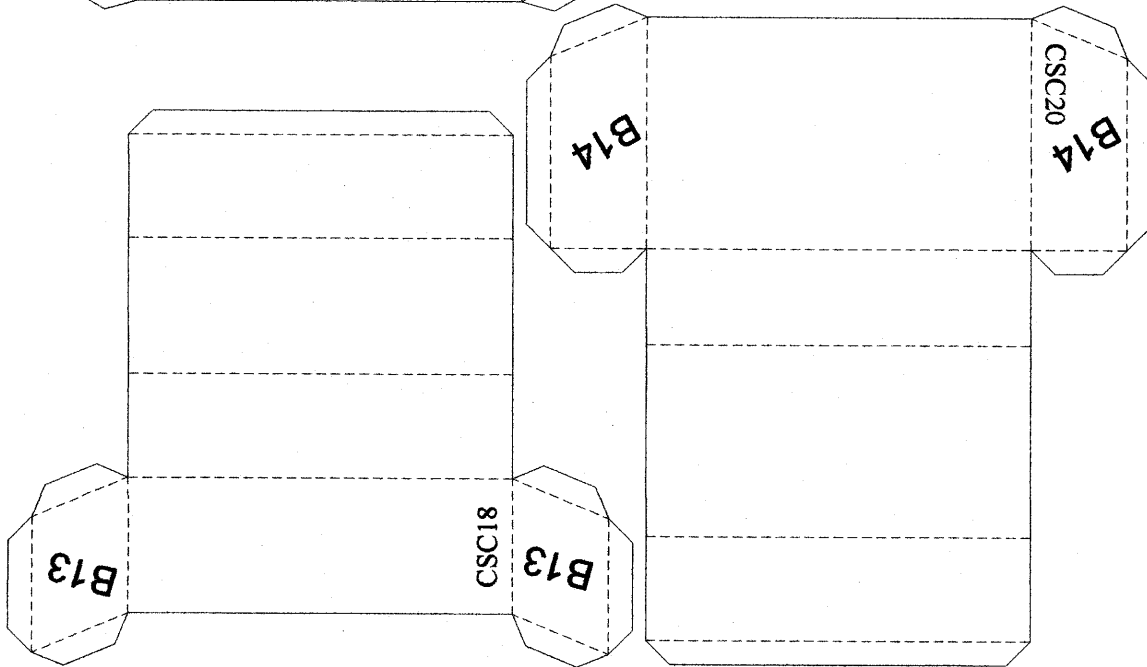
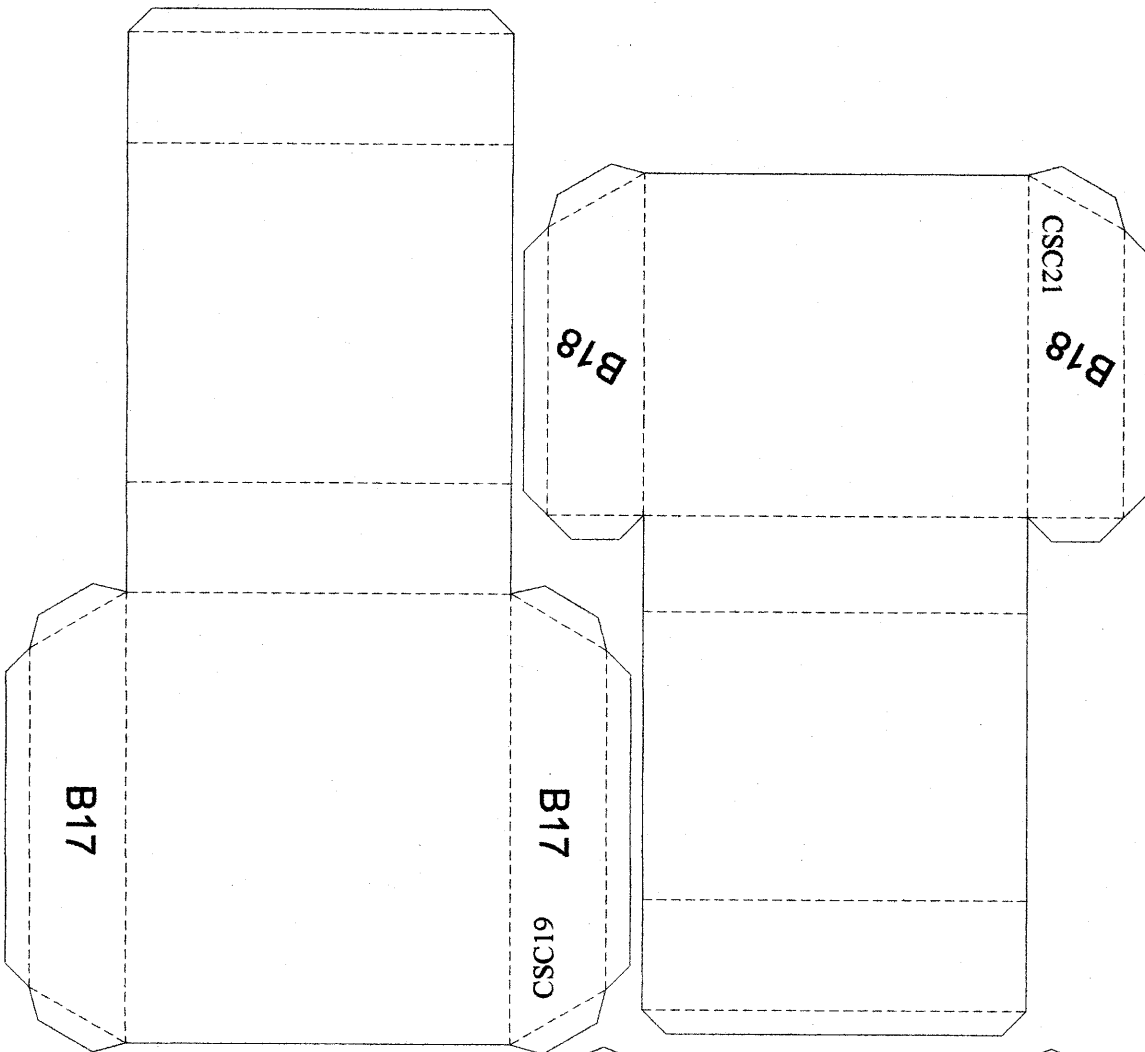
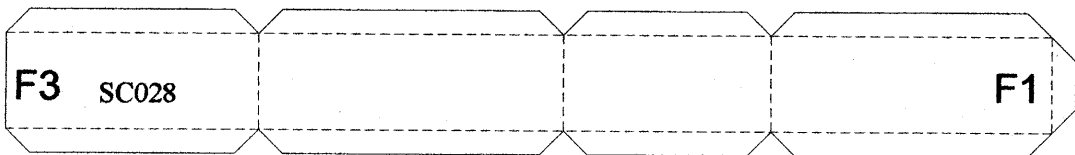

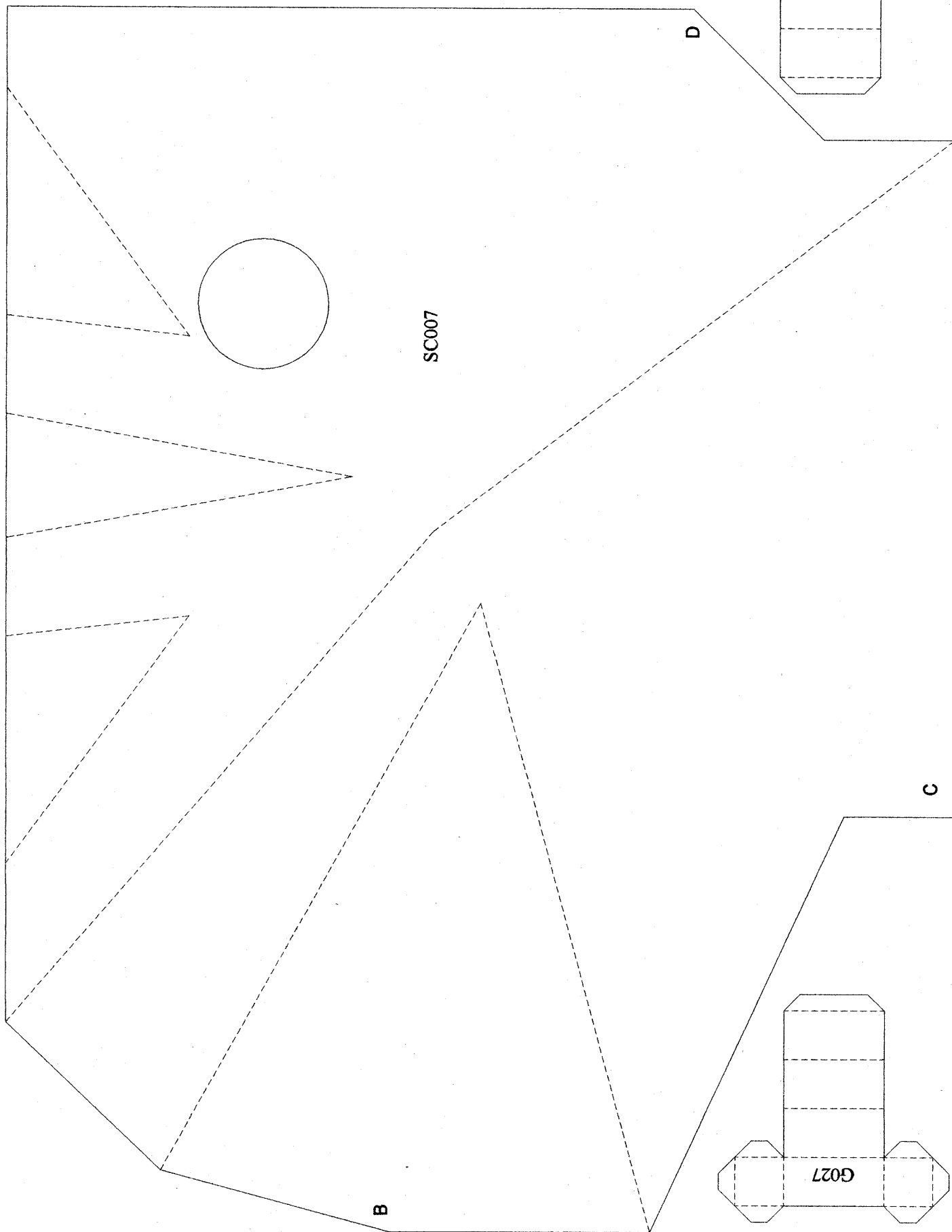

SC007

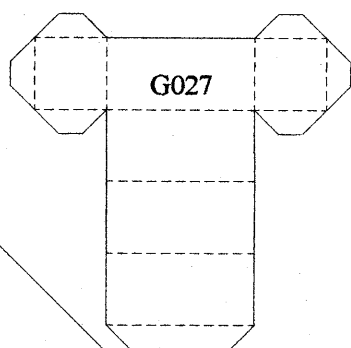

G027

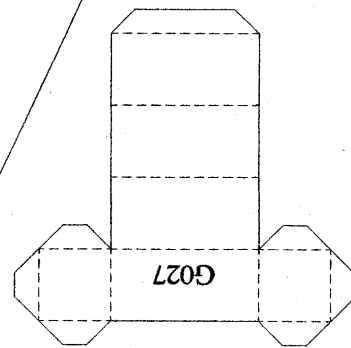

G027



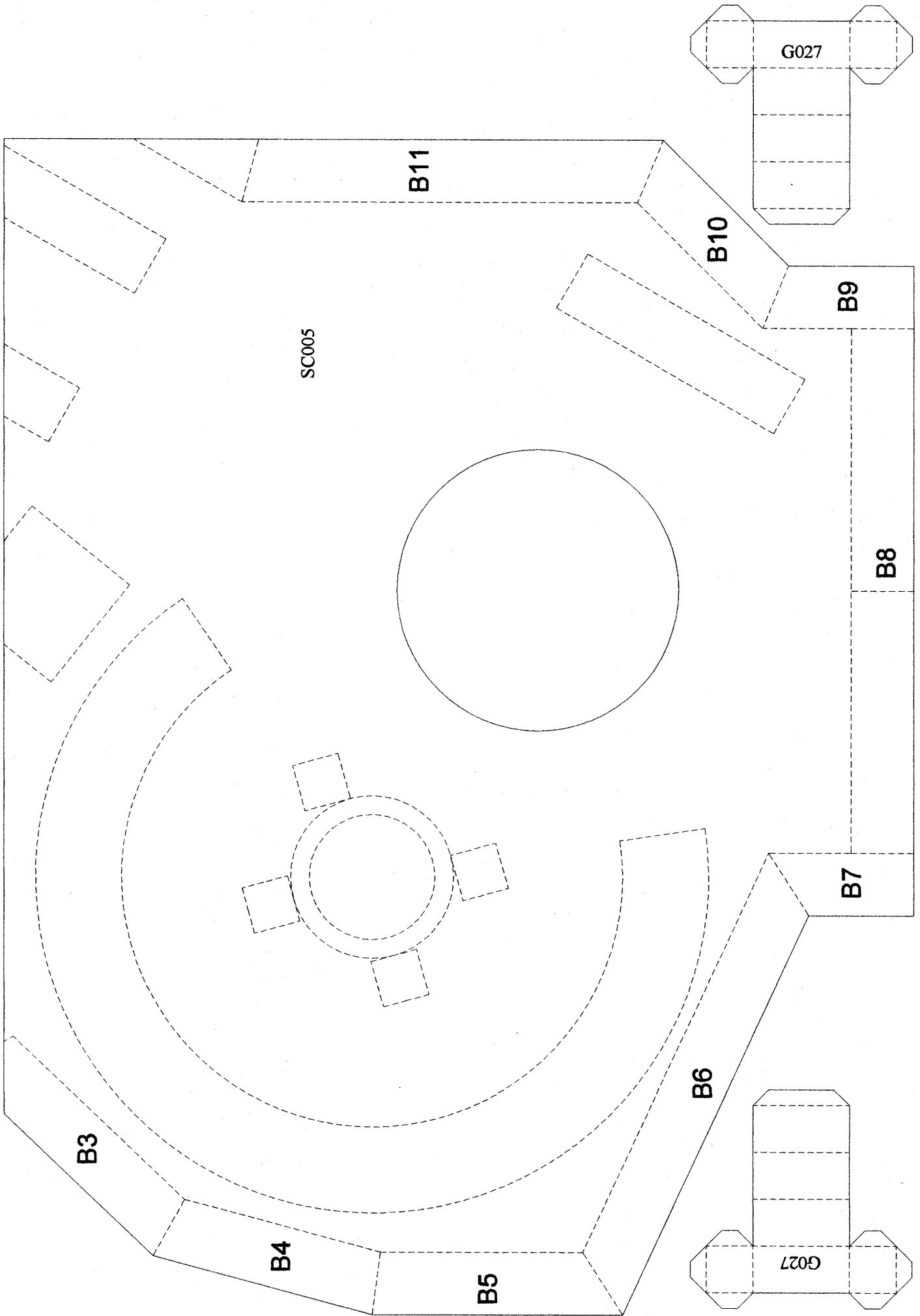

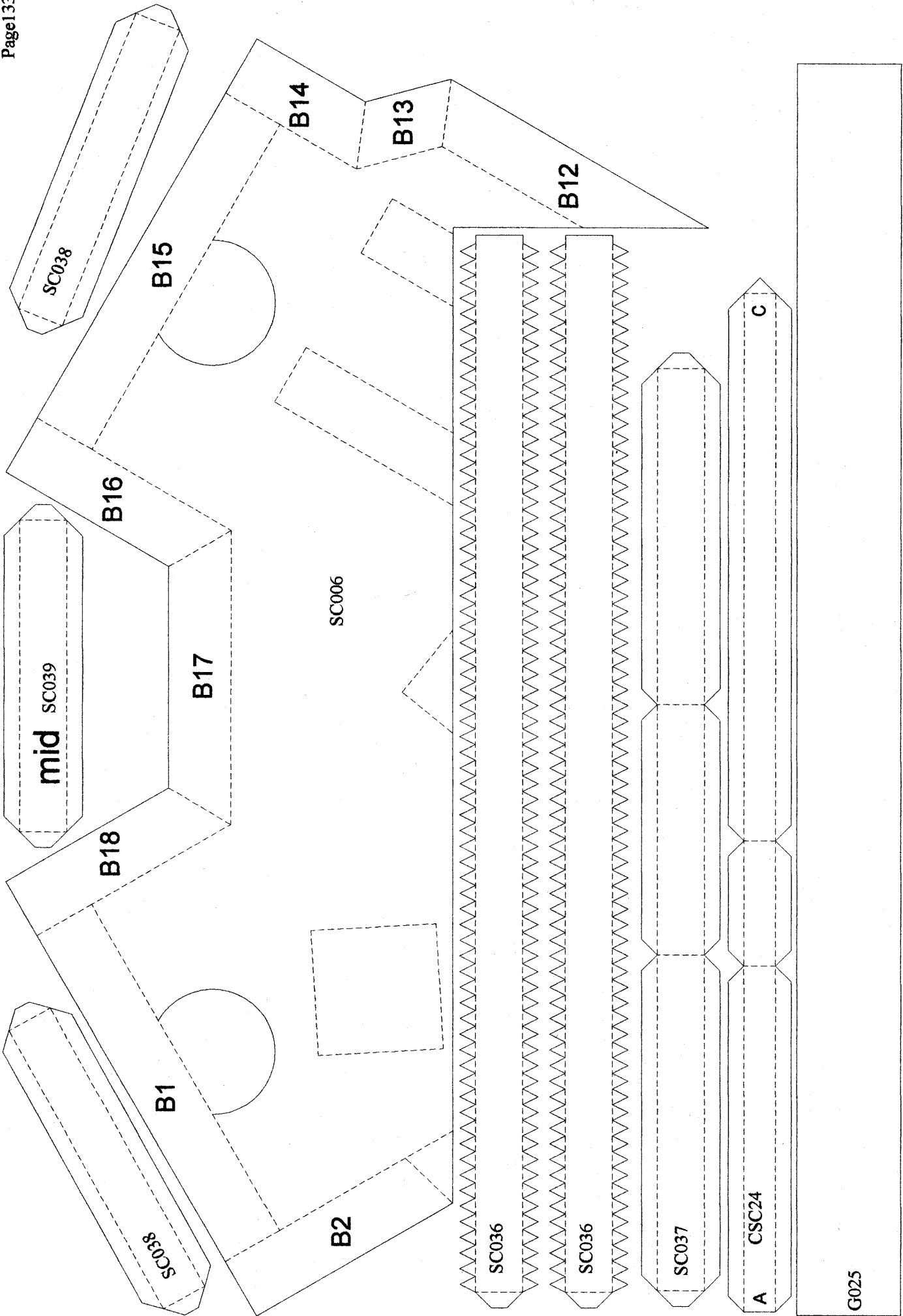

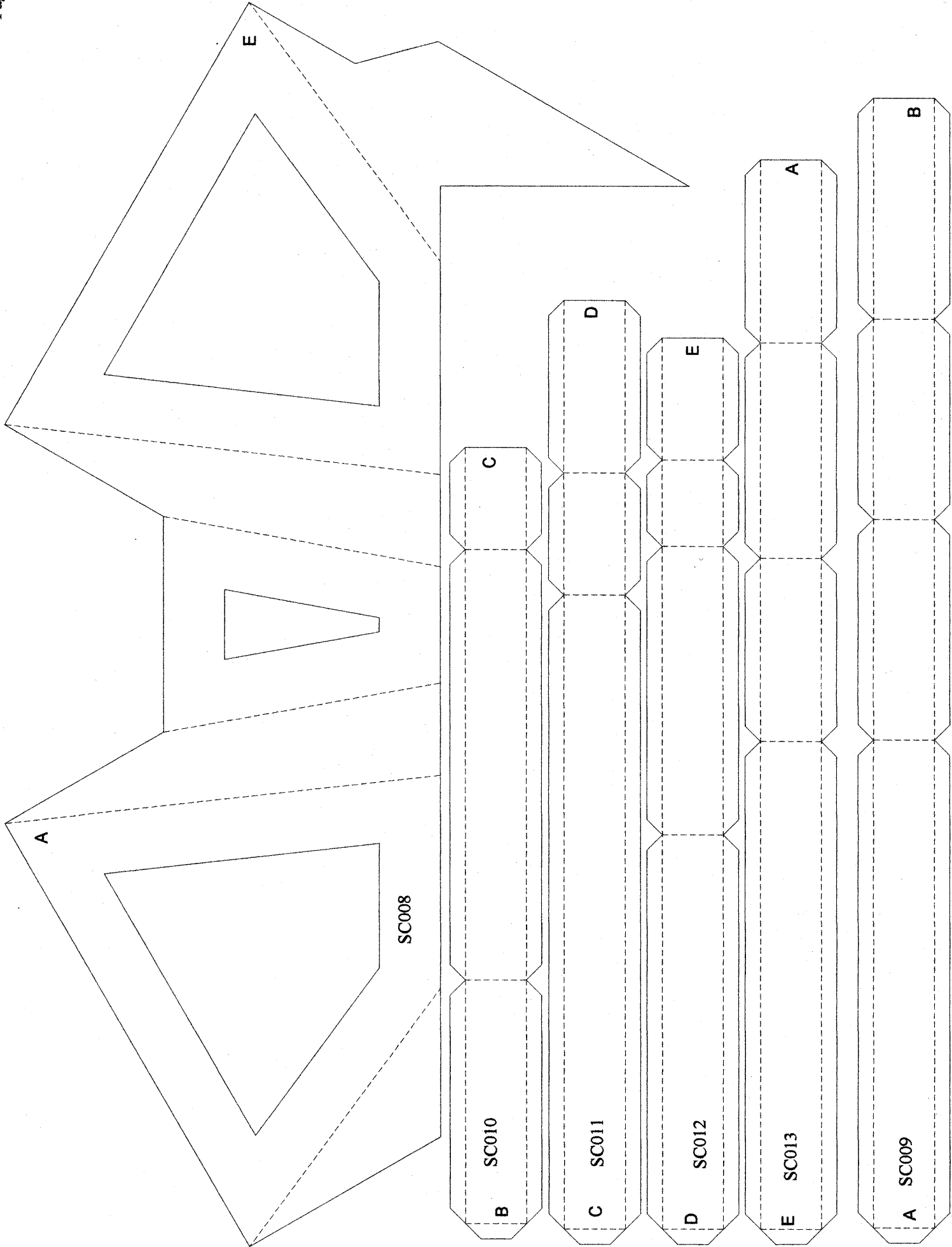

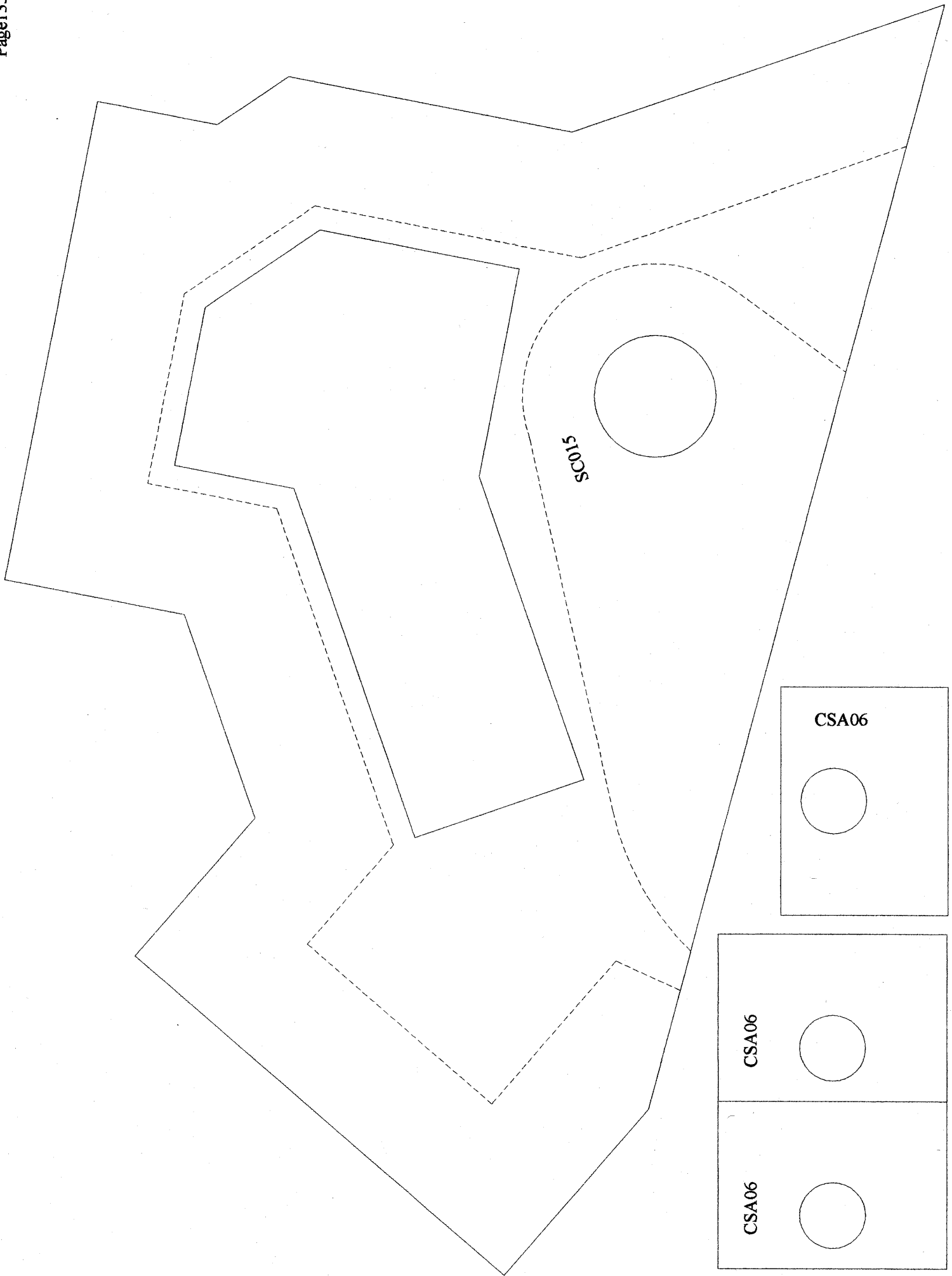

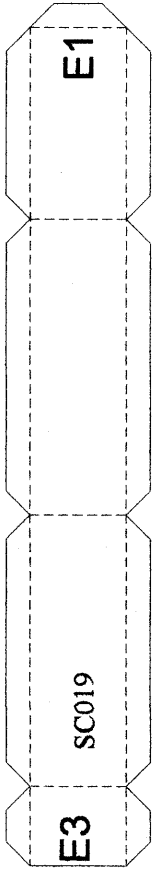
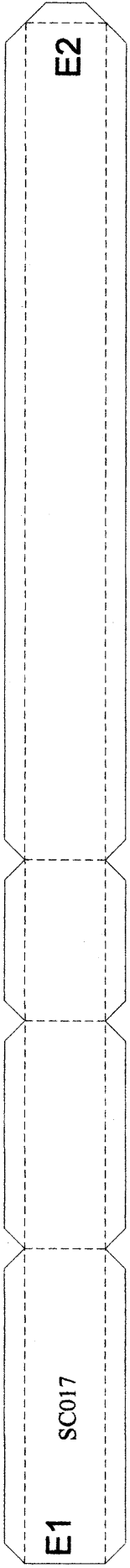
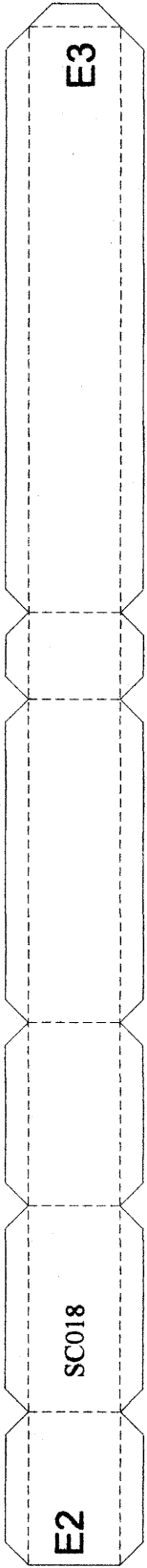

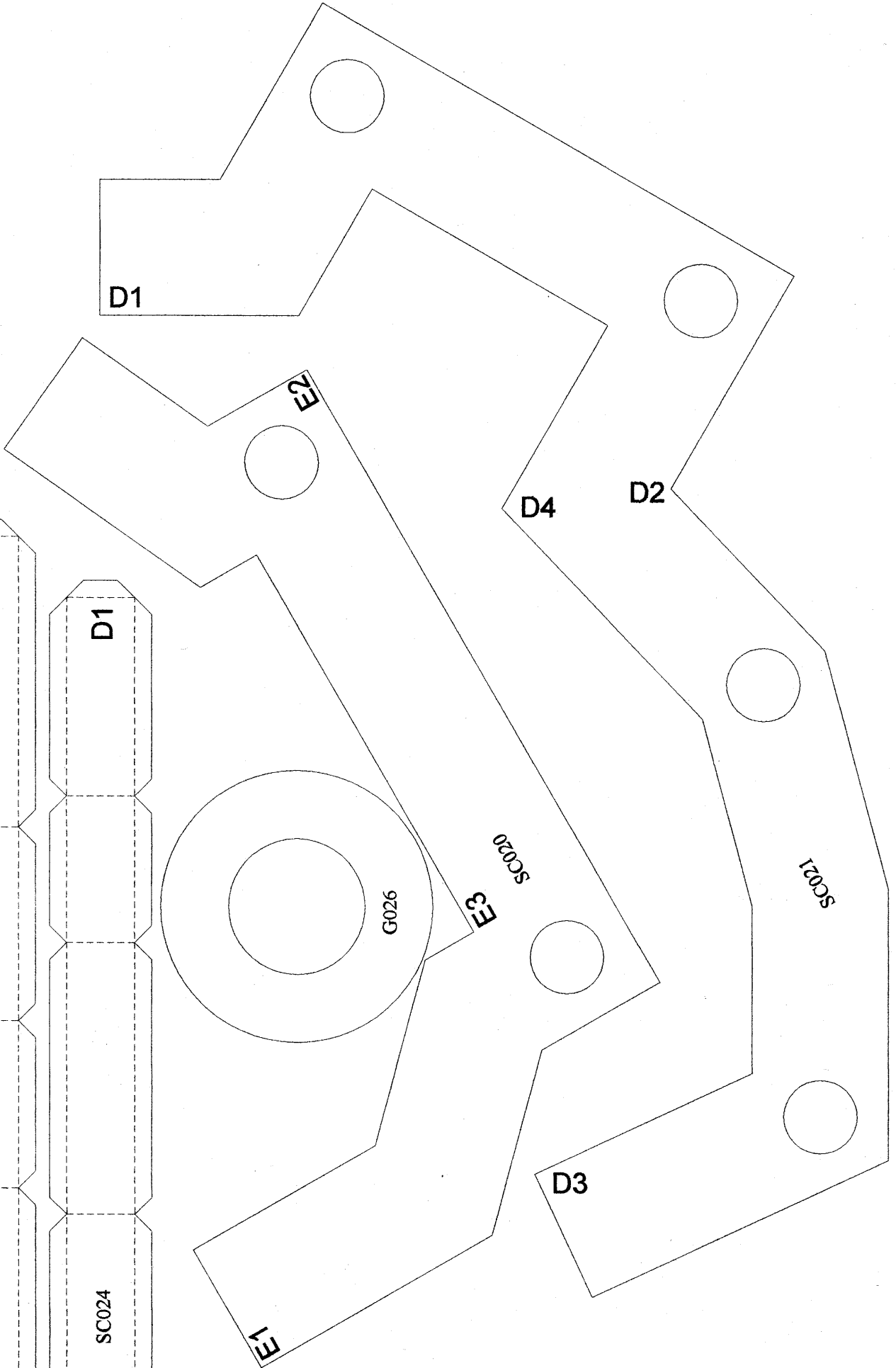
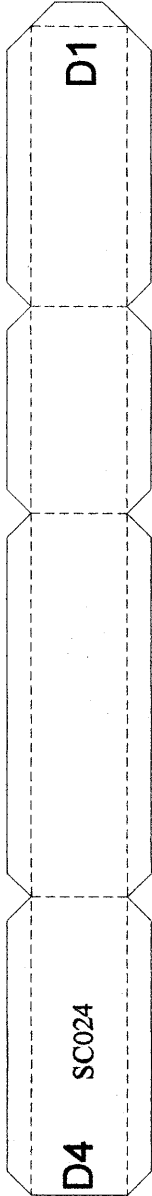
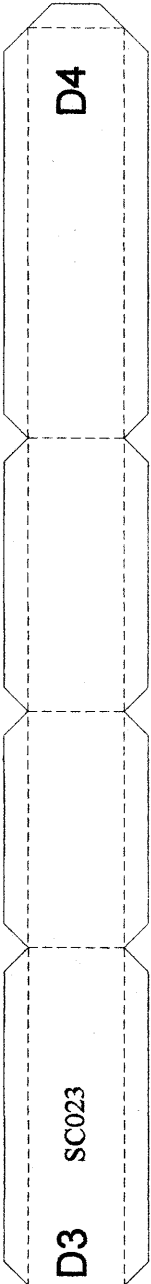
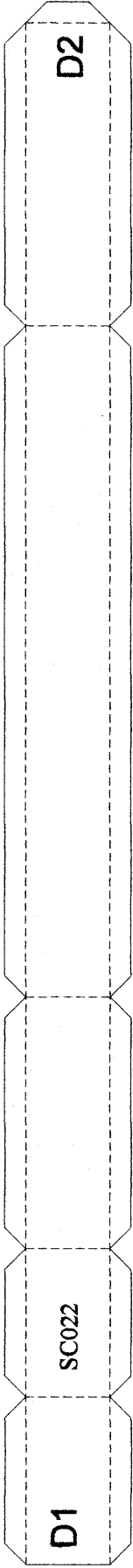

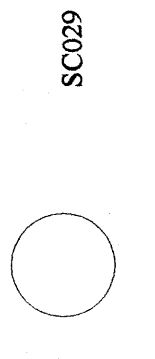
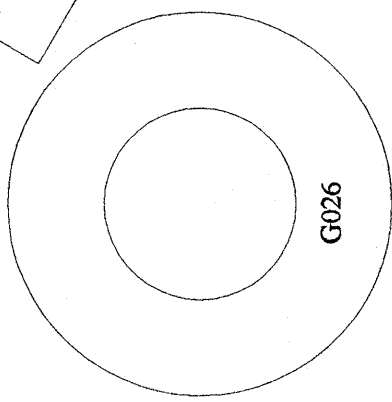
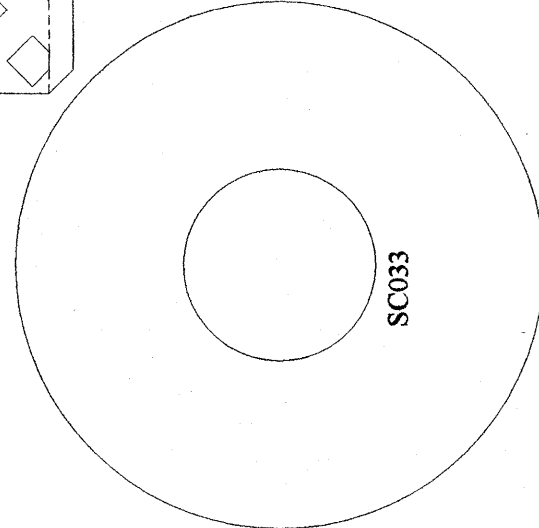
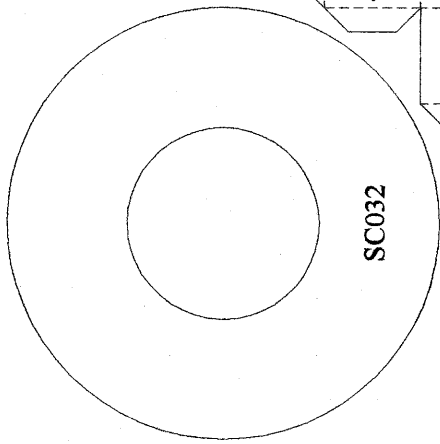
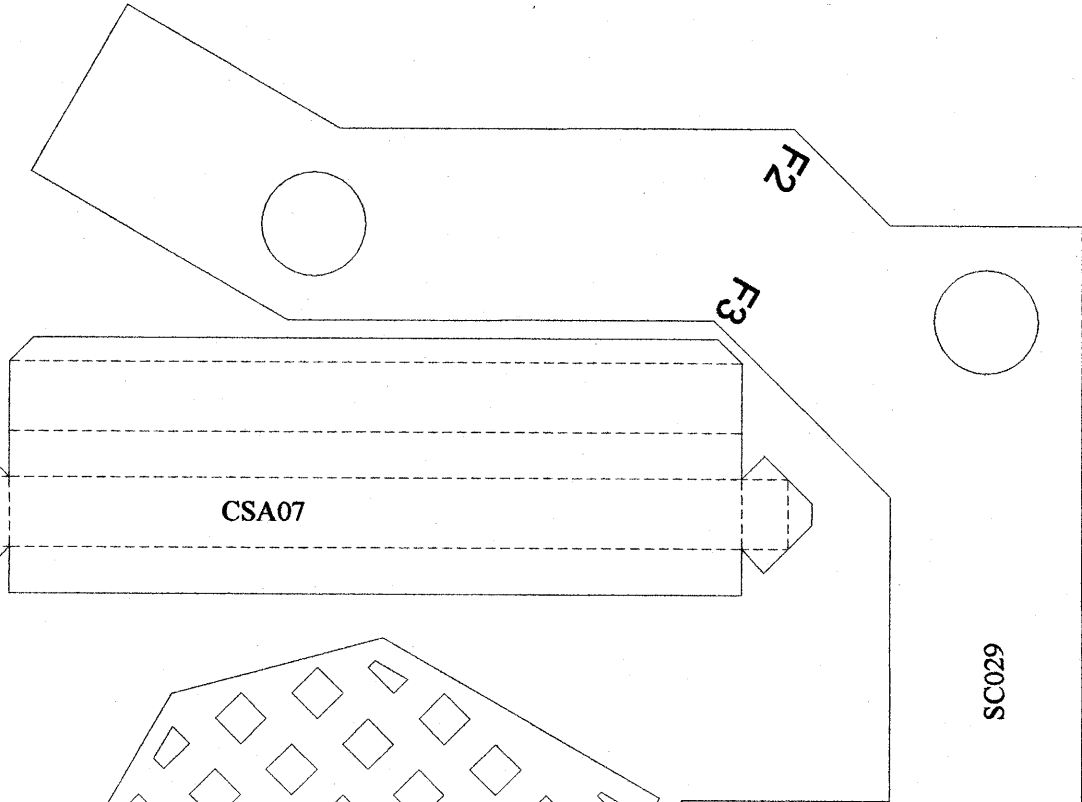
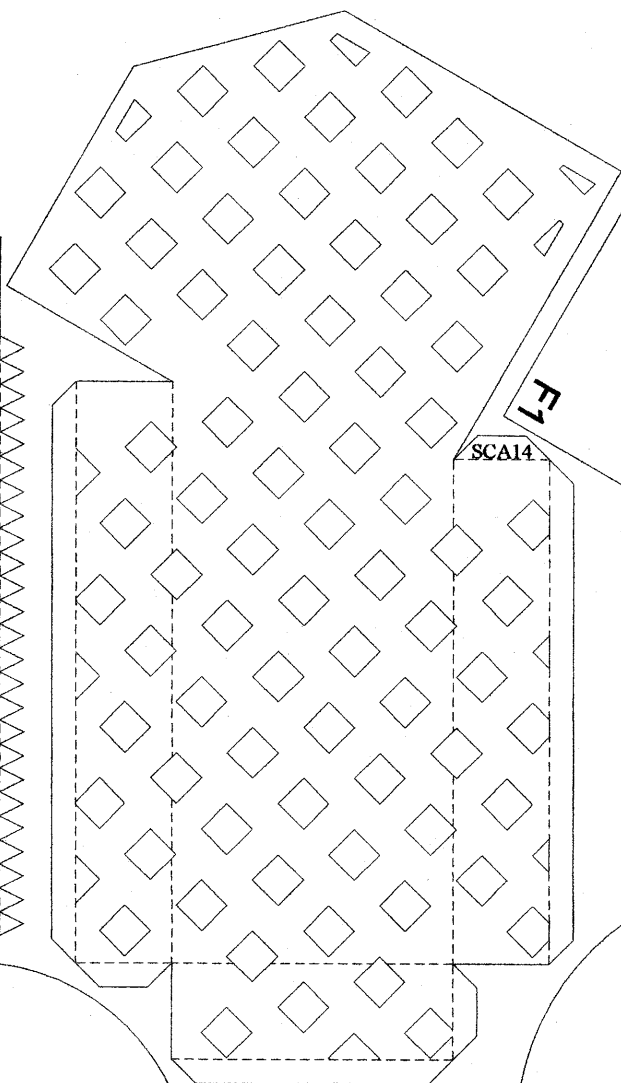
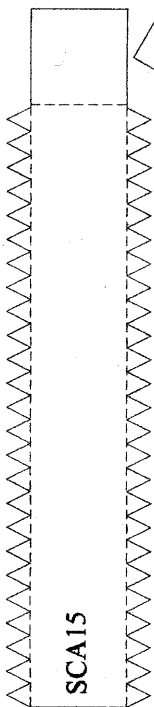
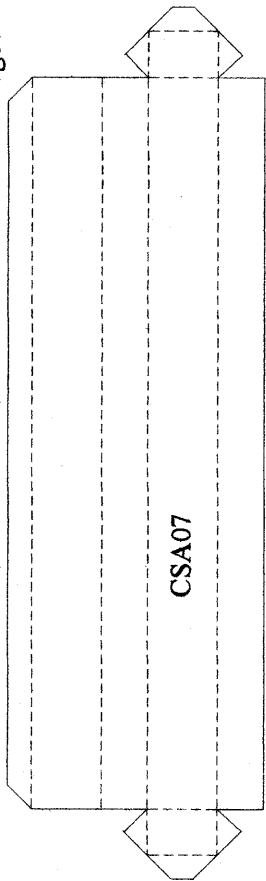
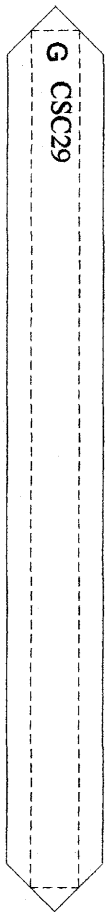
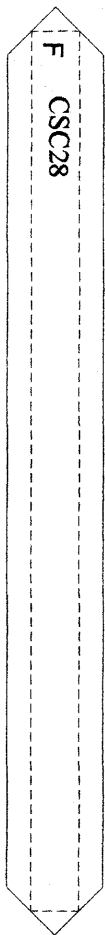

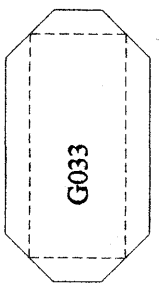
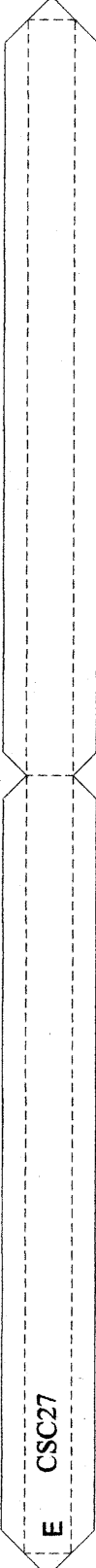
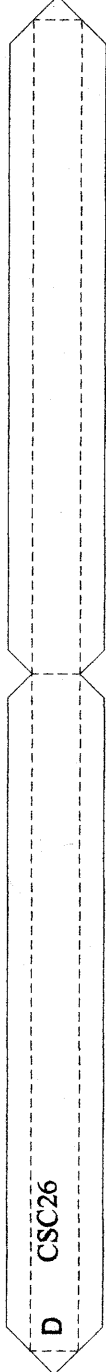
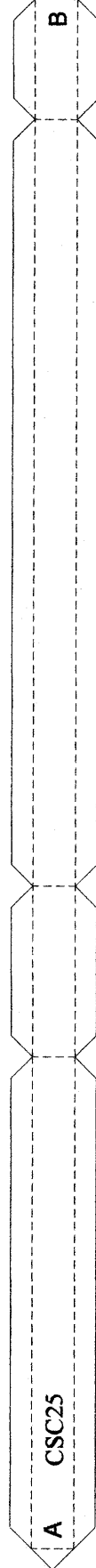
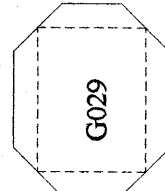
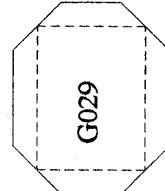
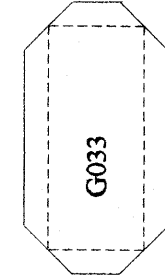
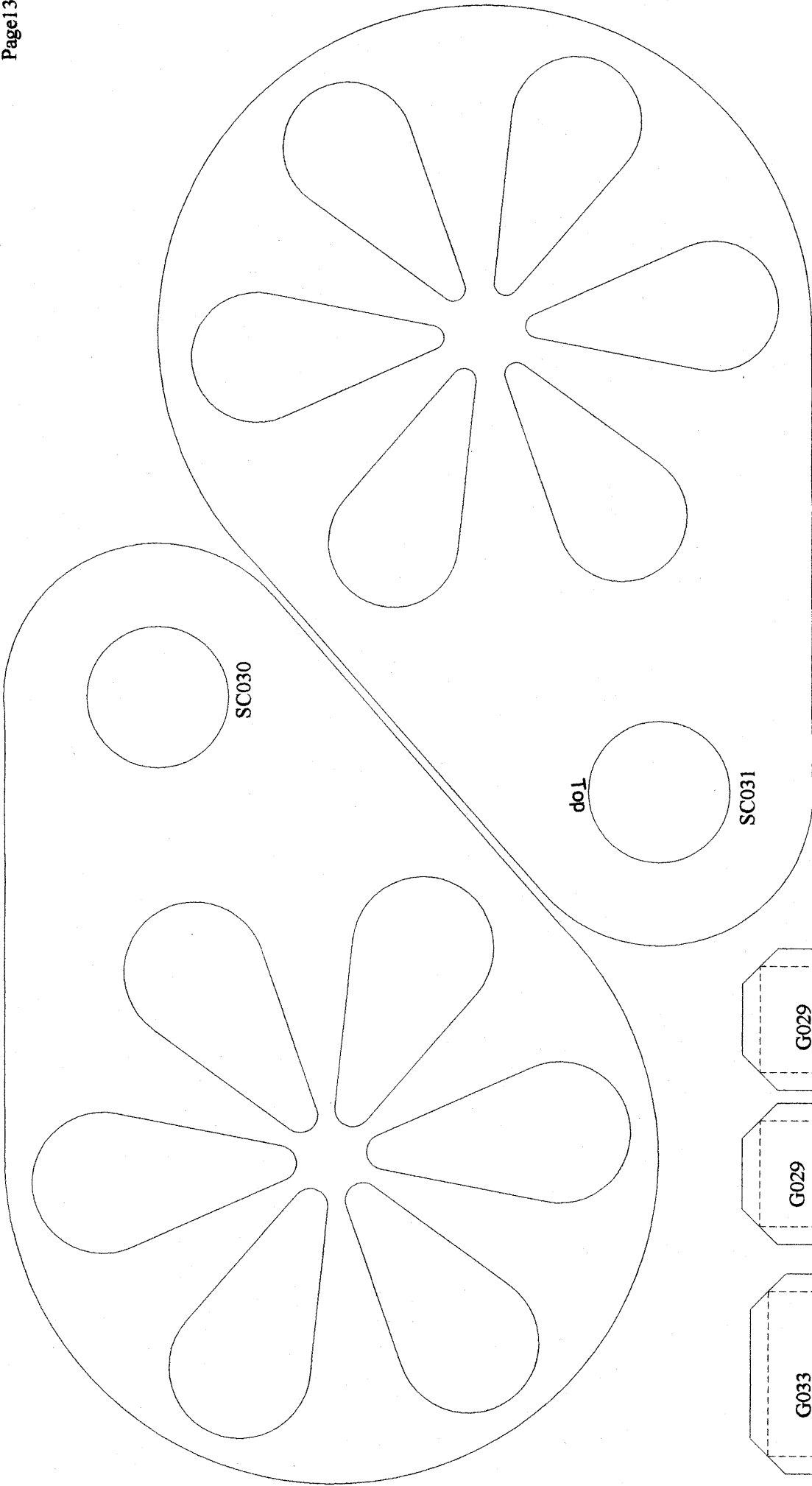



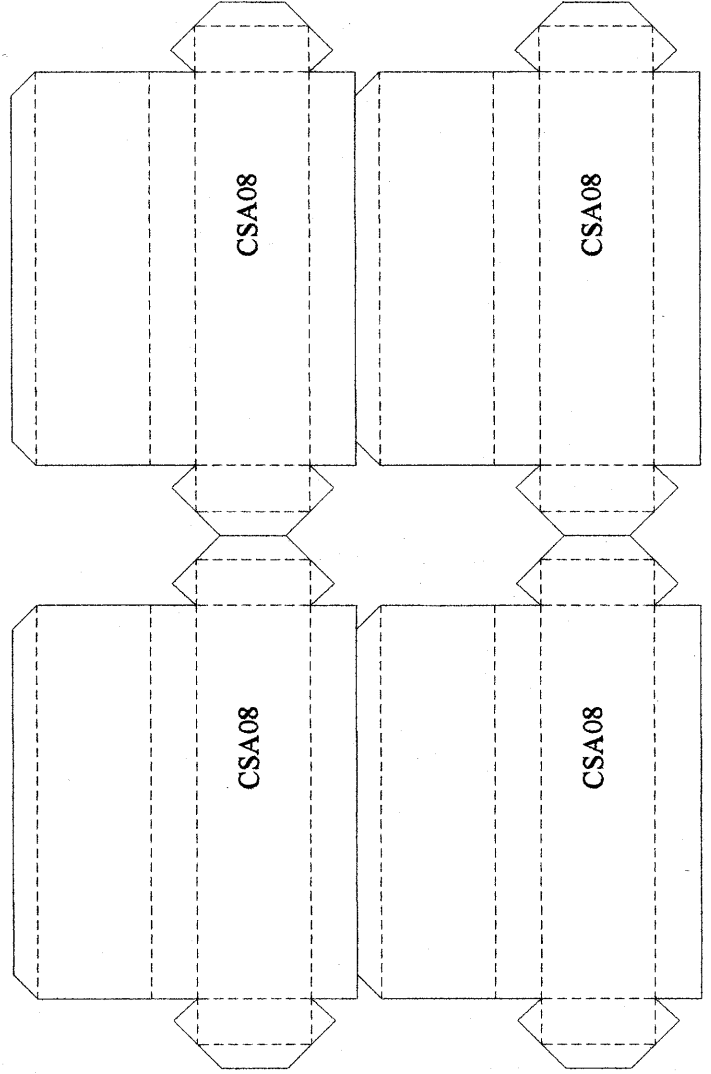
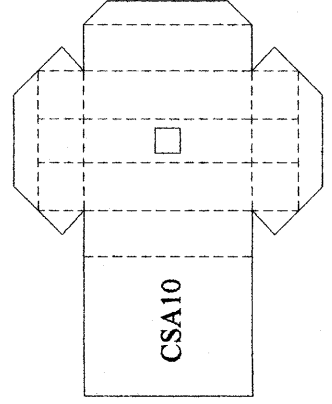
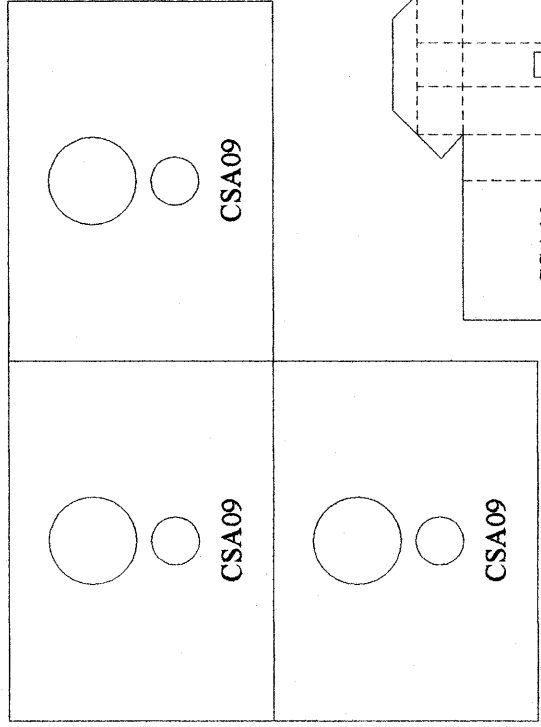
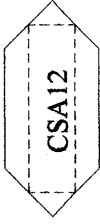
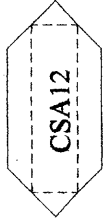
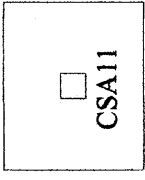
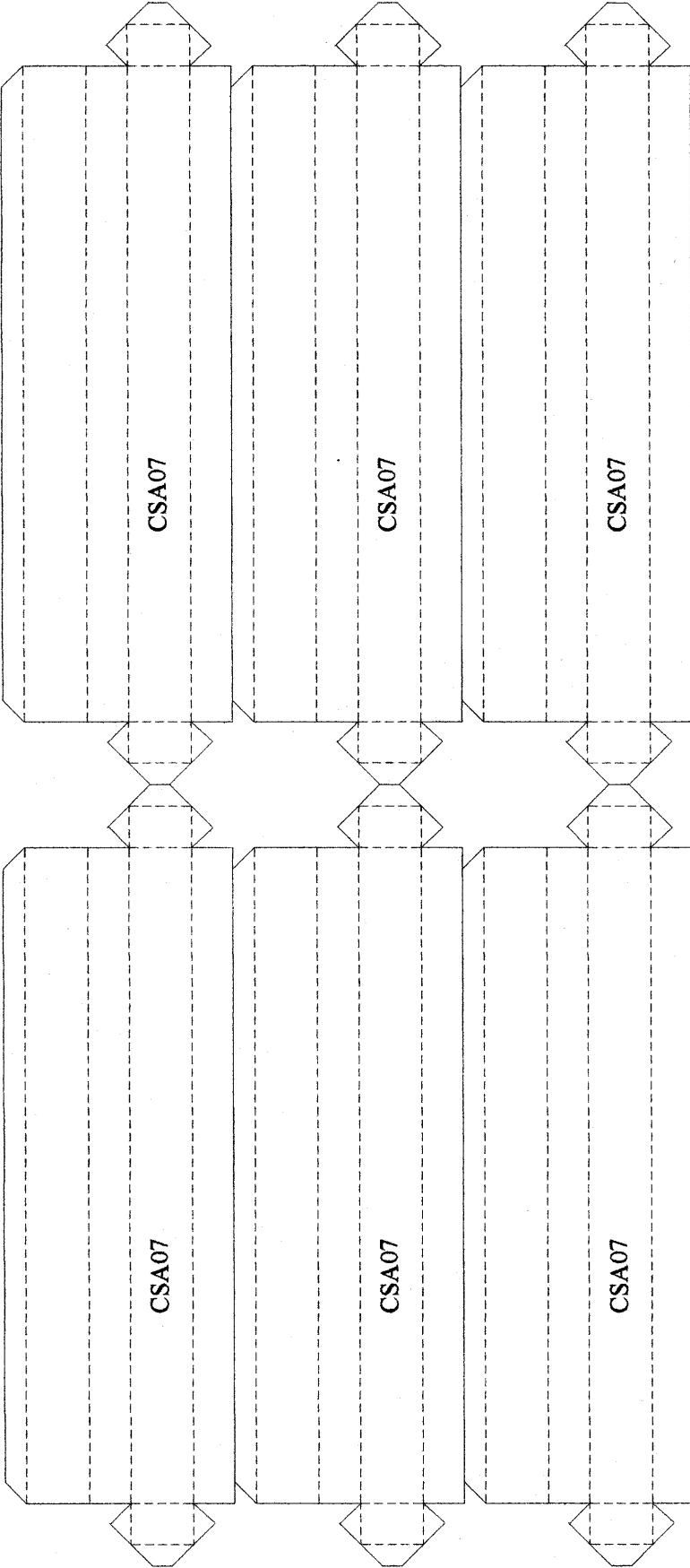

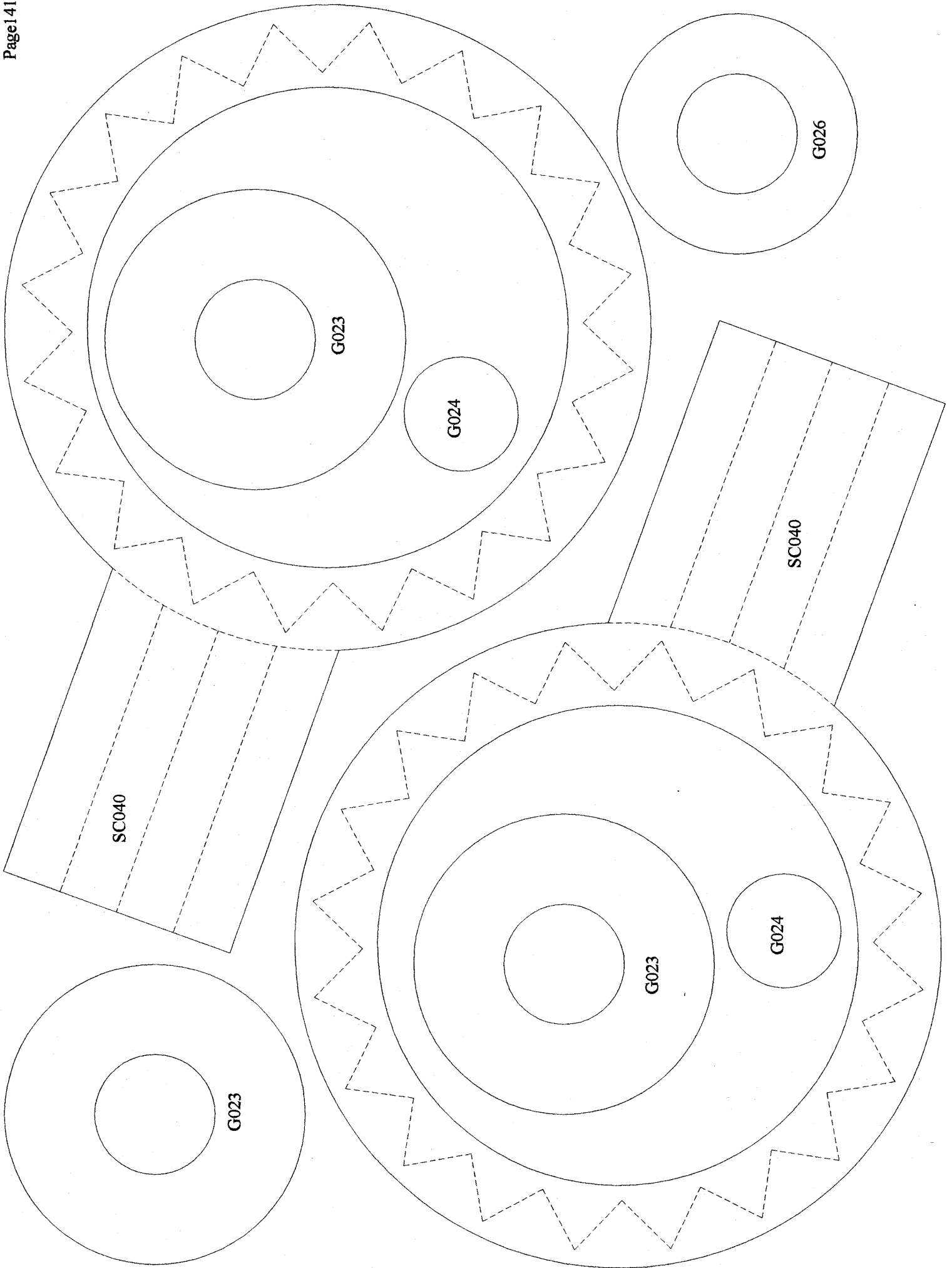

G025
G025
G025
G025

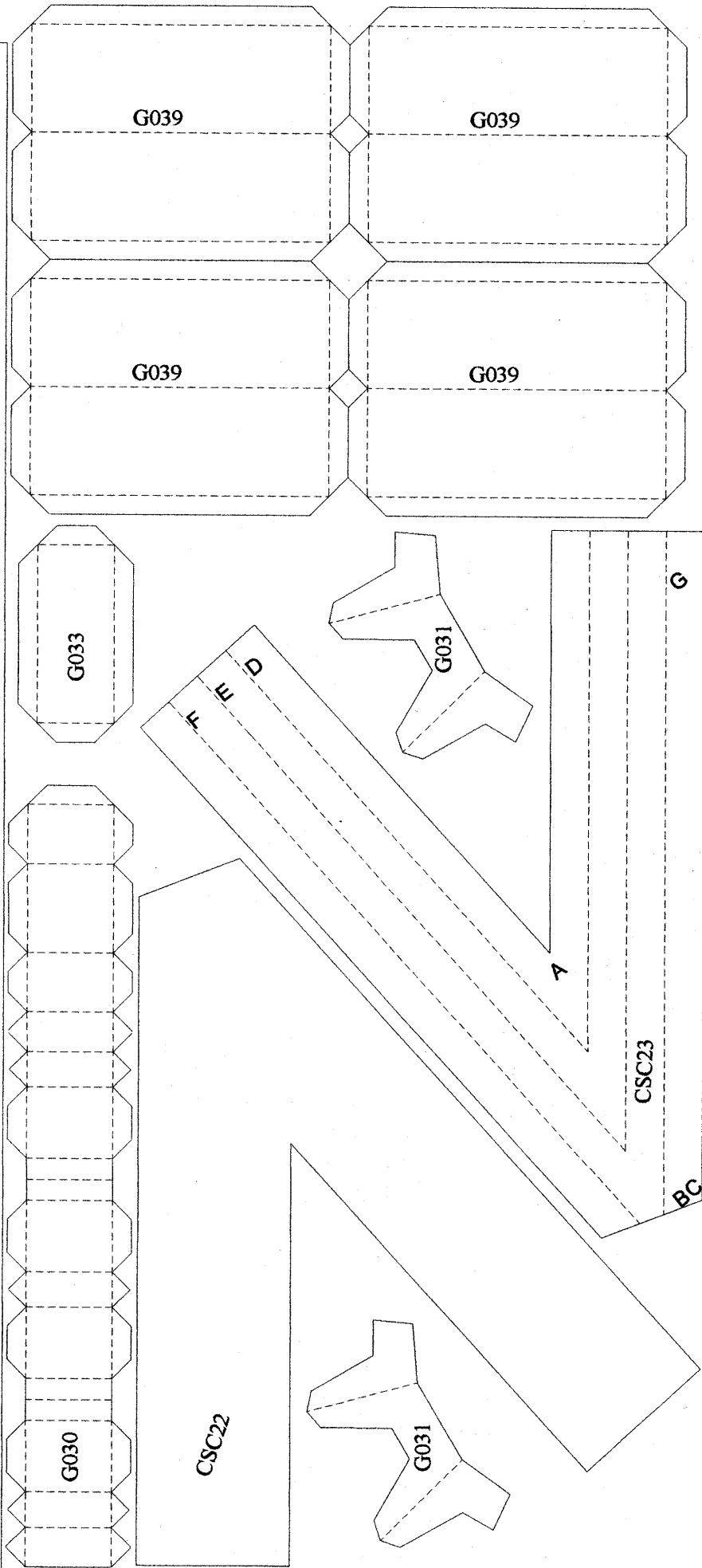

G021

G021

G021

G020

G025
G025
G025
G022
G022
G022
G022
G021

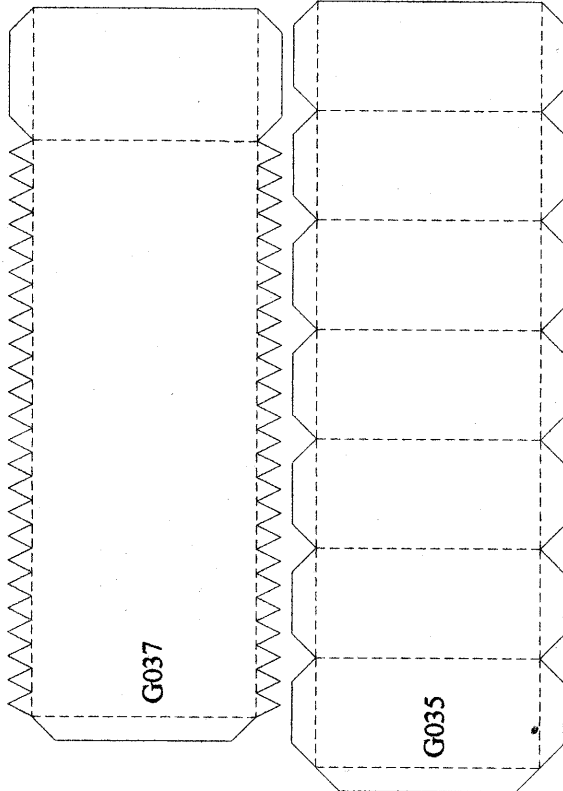
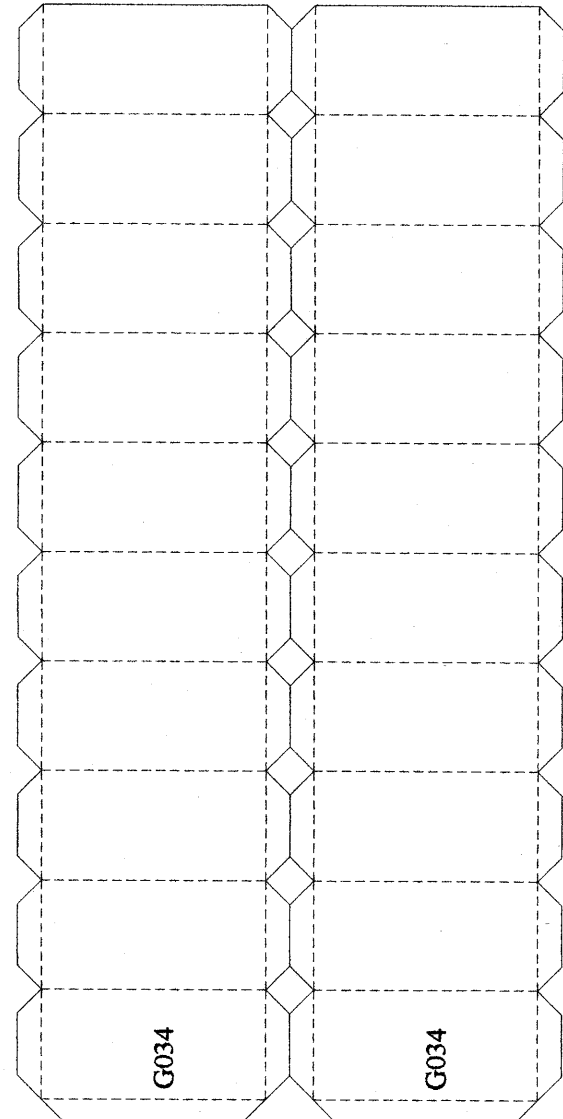
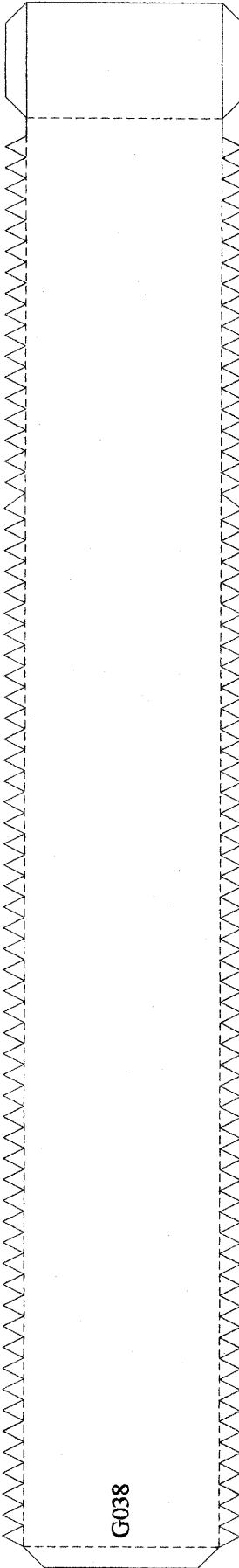
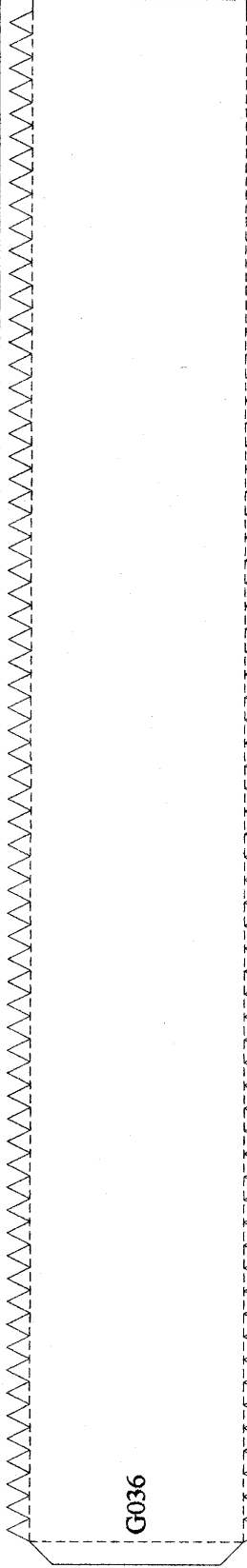
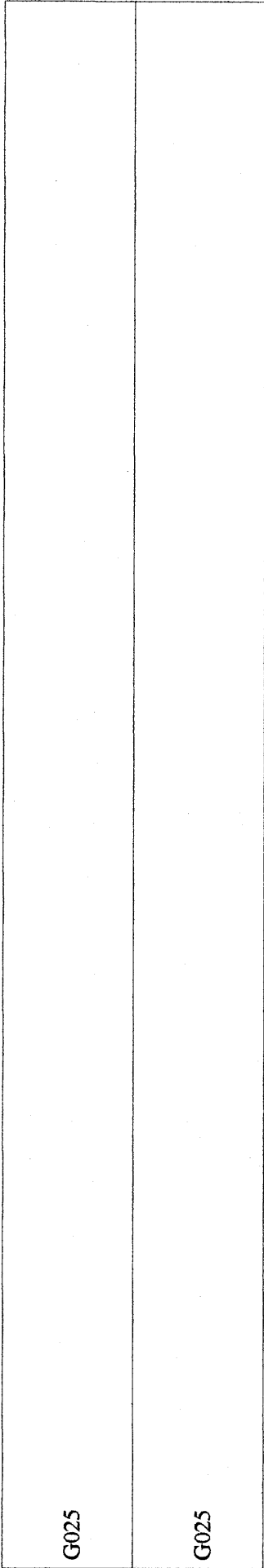

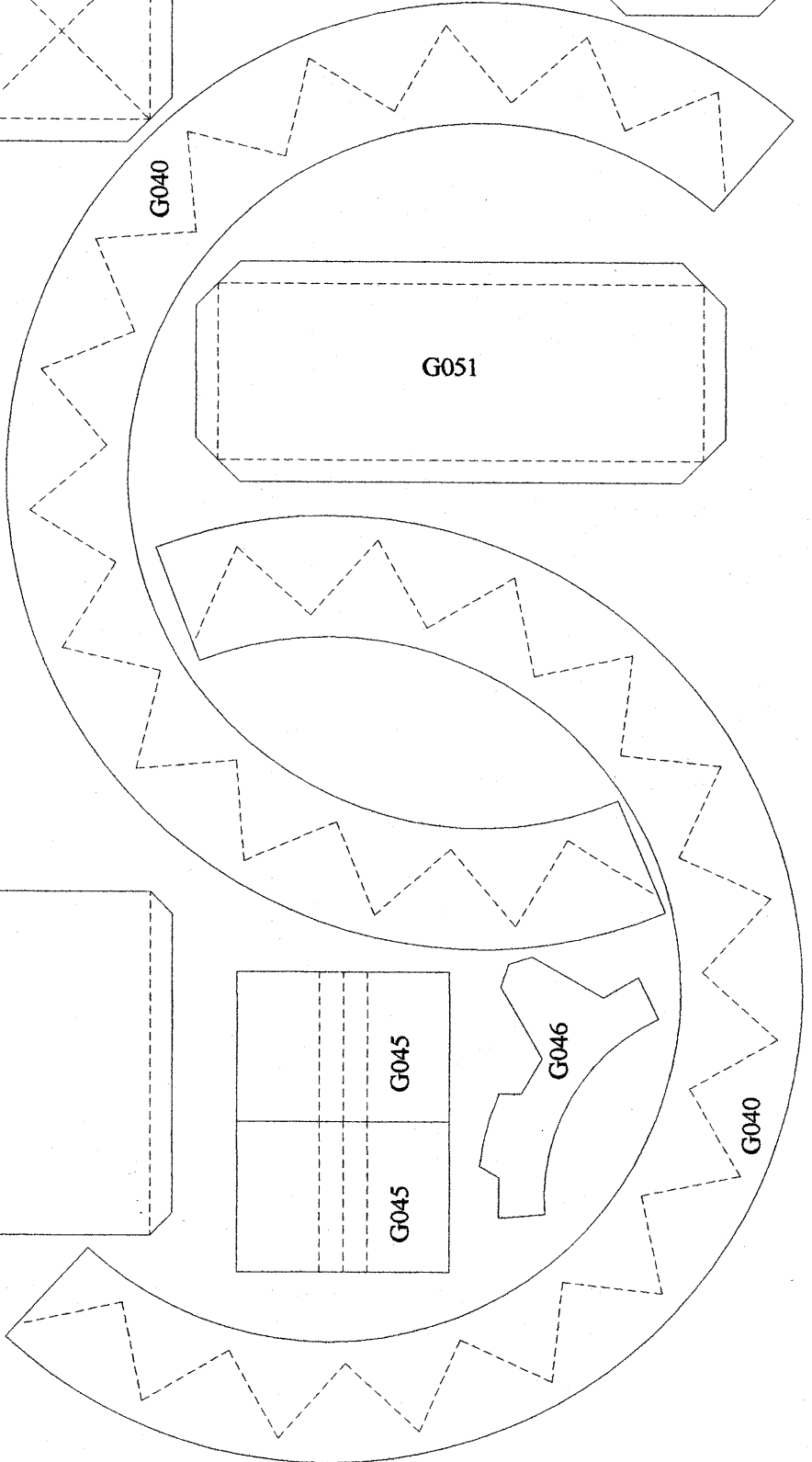
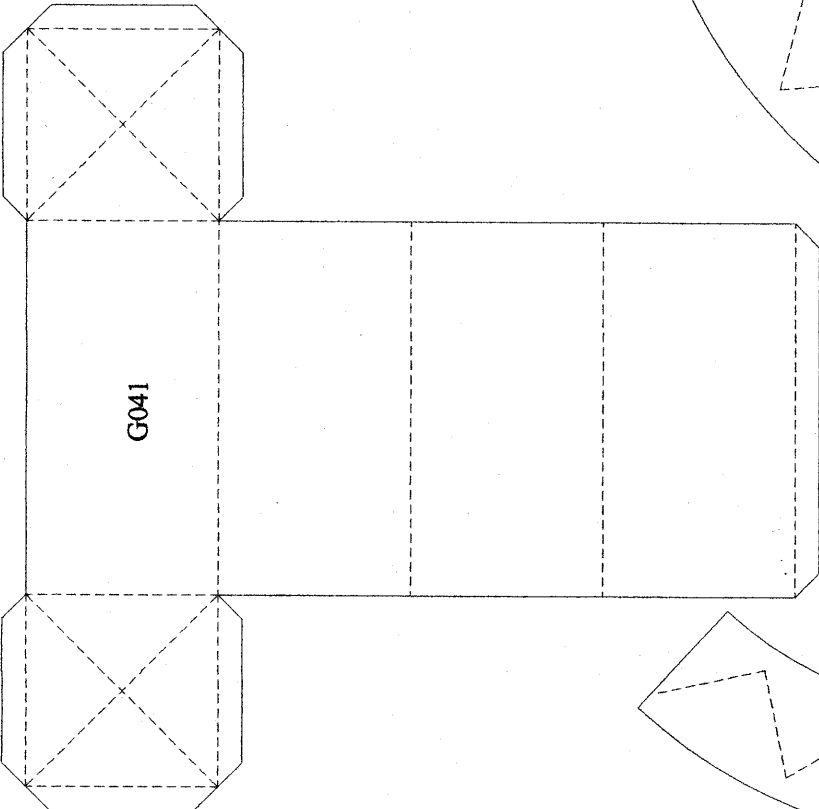
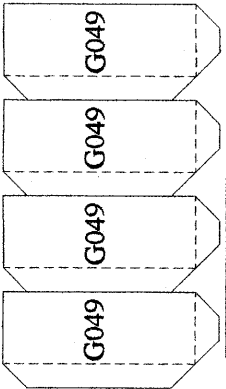
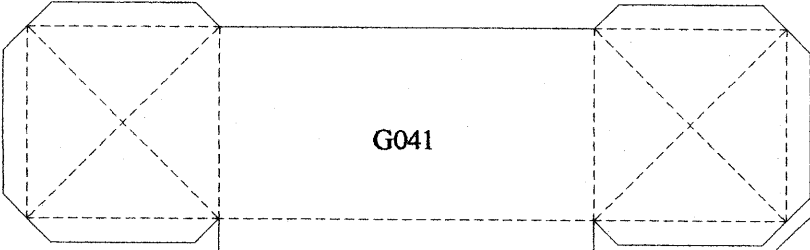
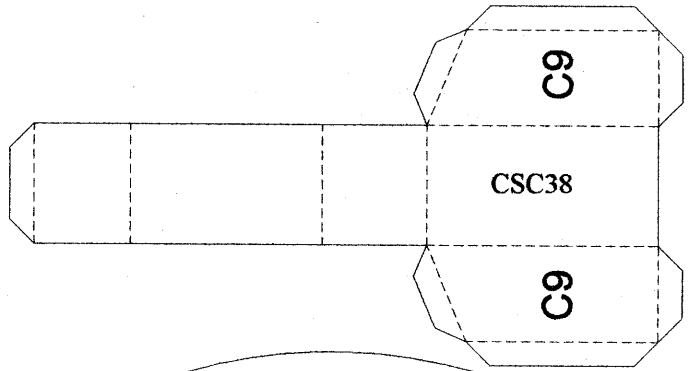
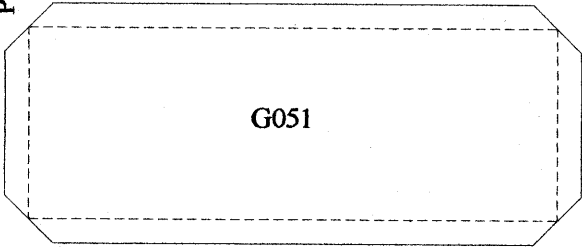

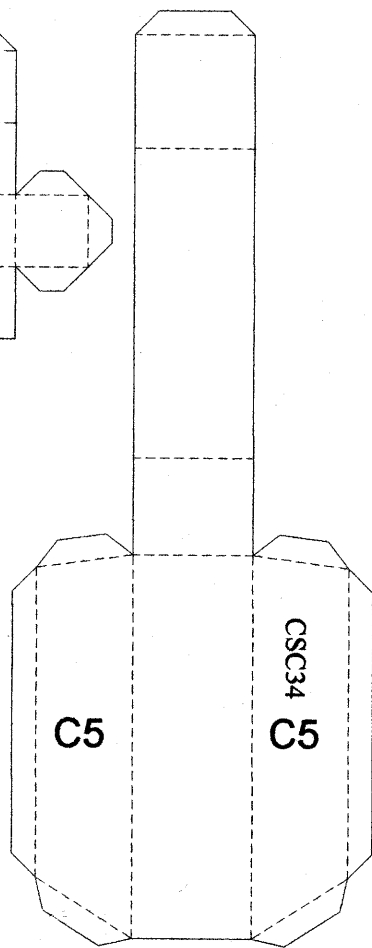
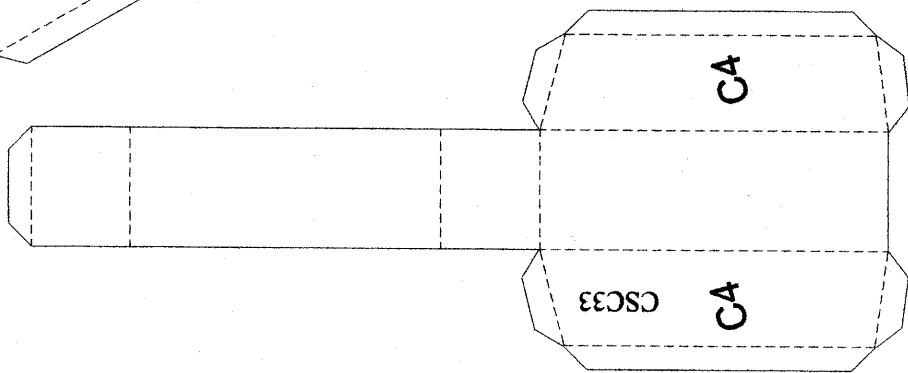
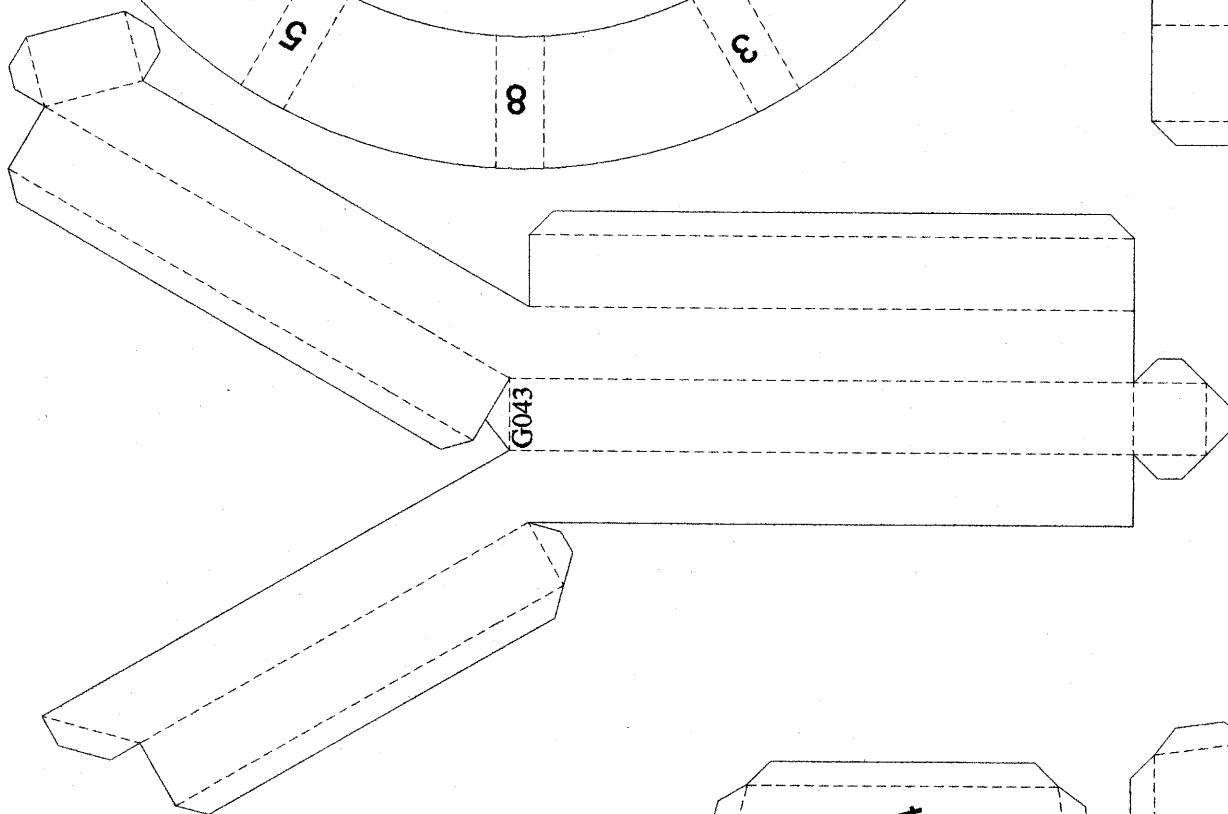
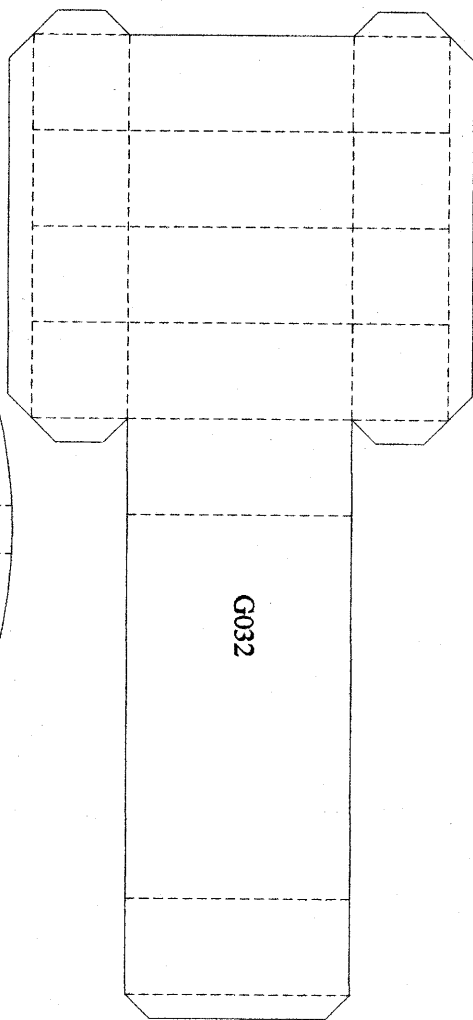
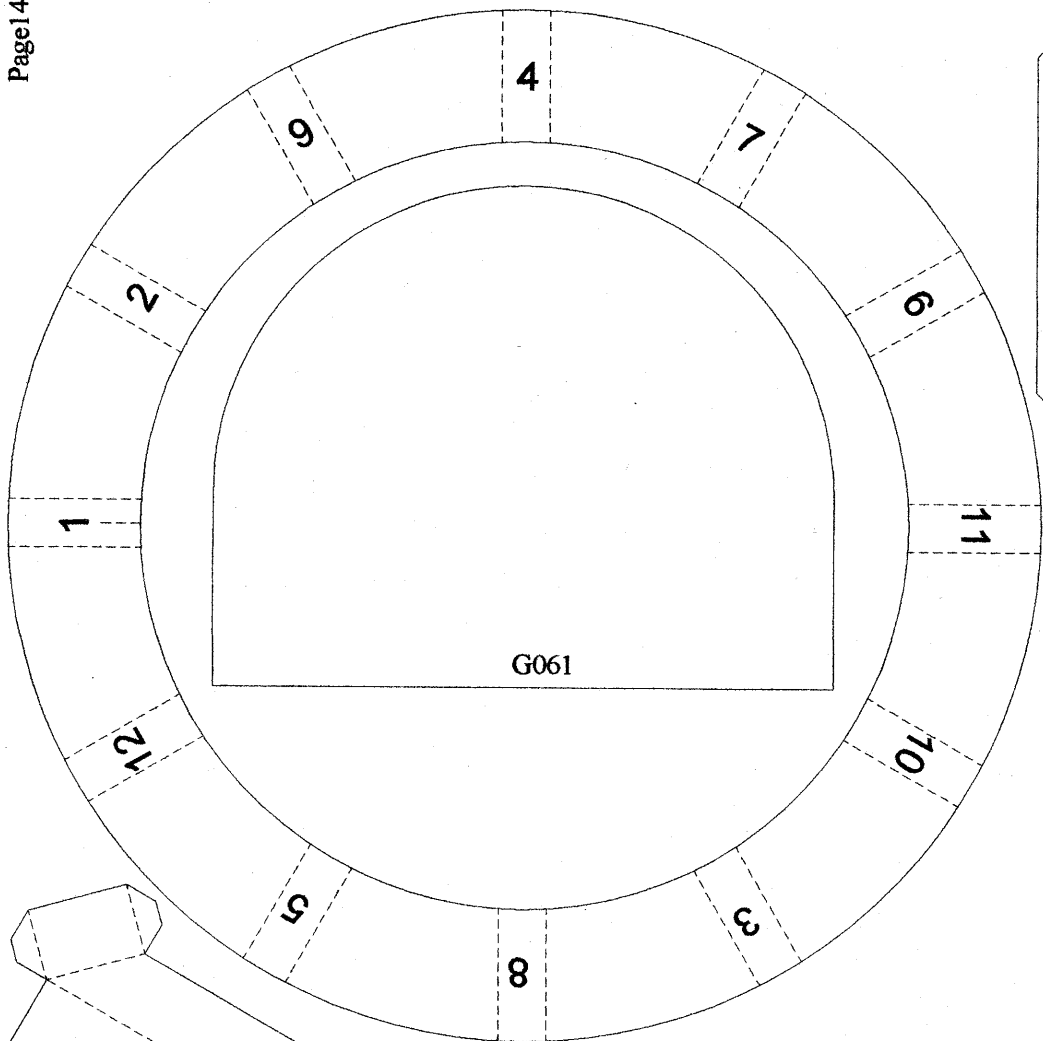



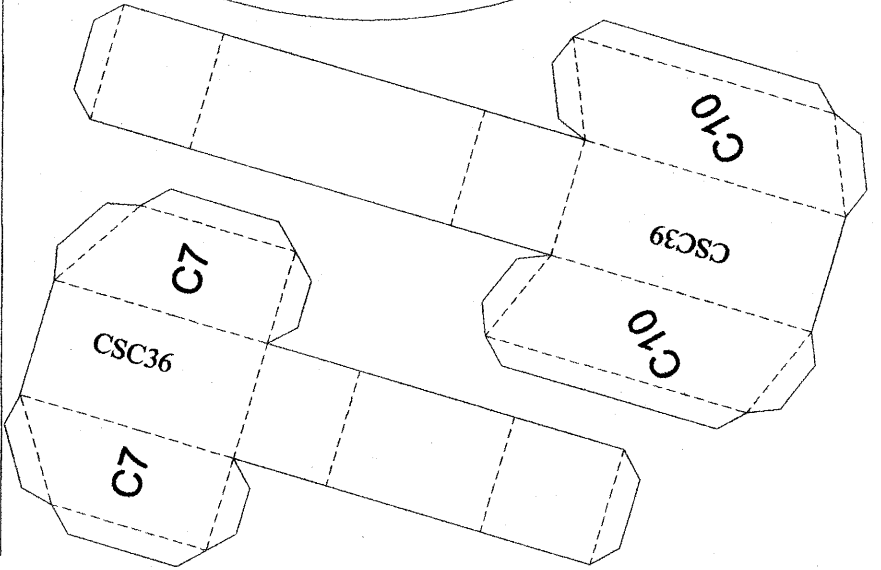
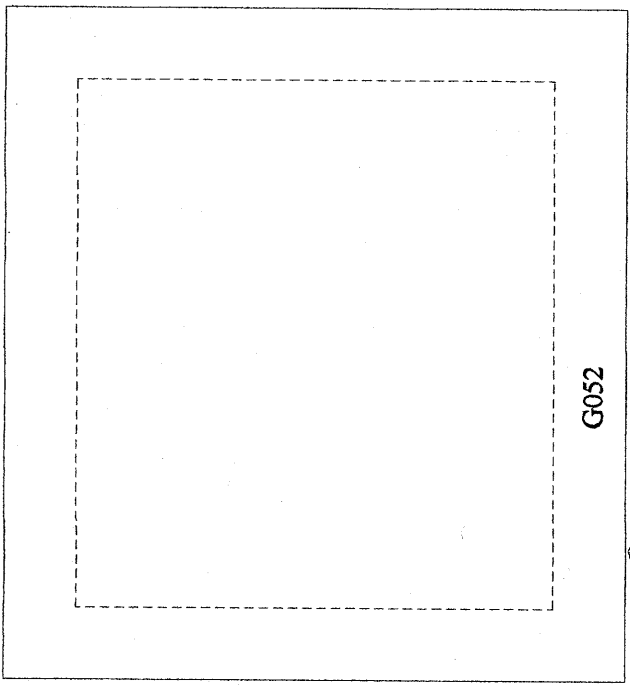
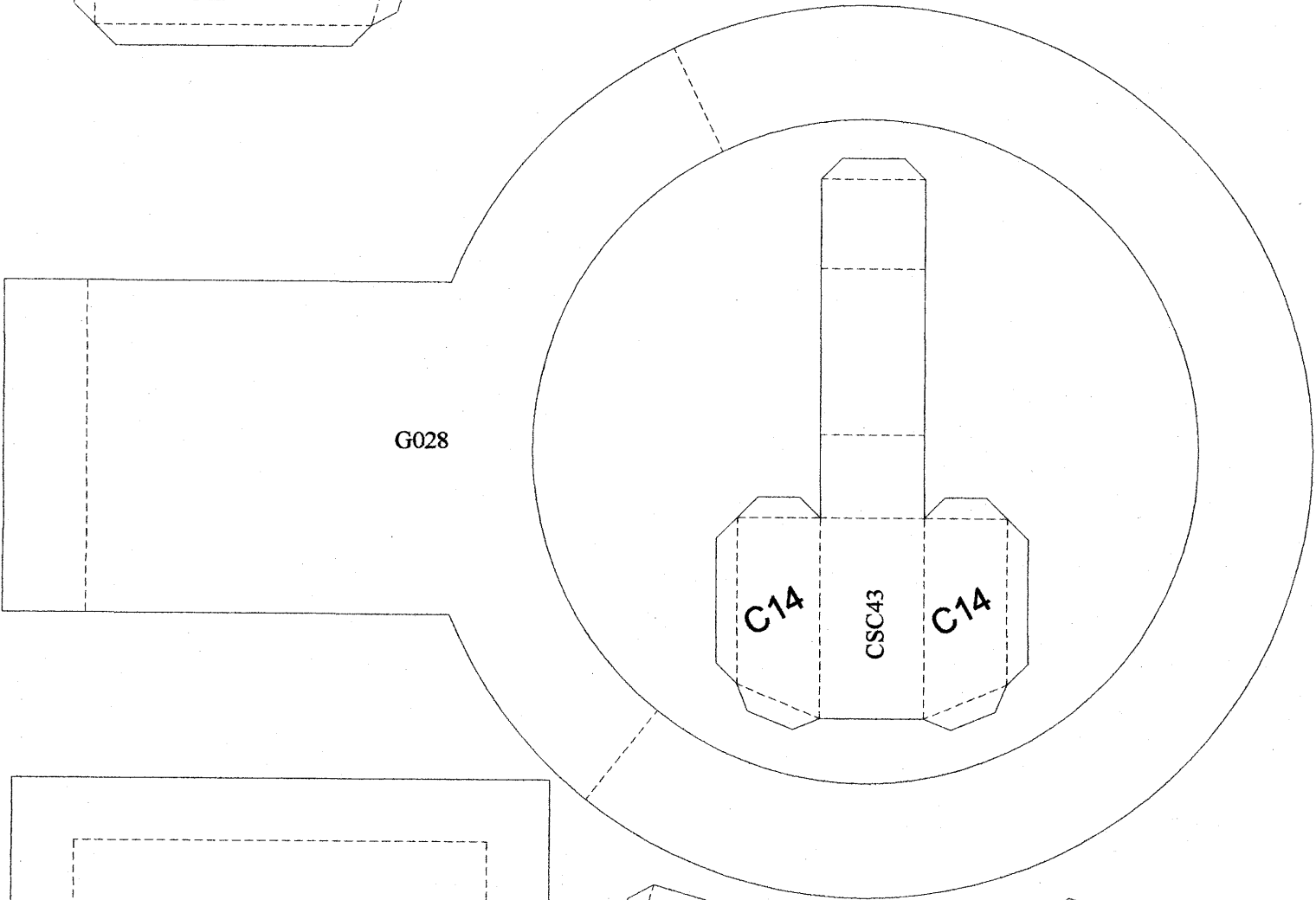
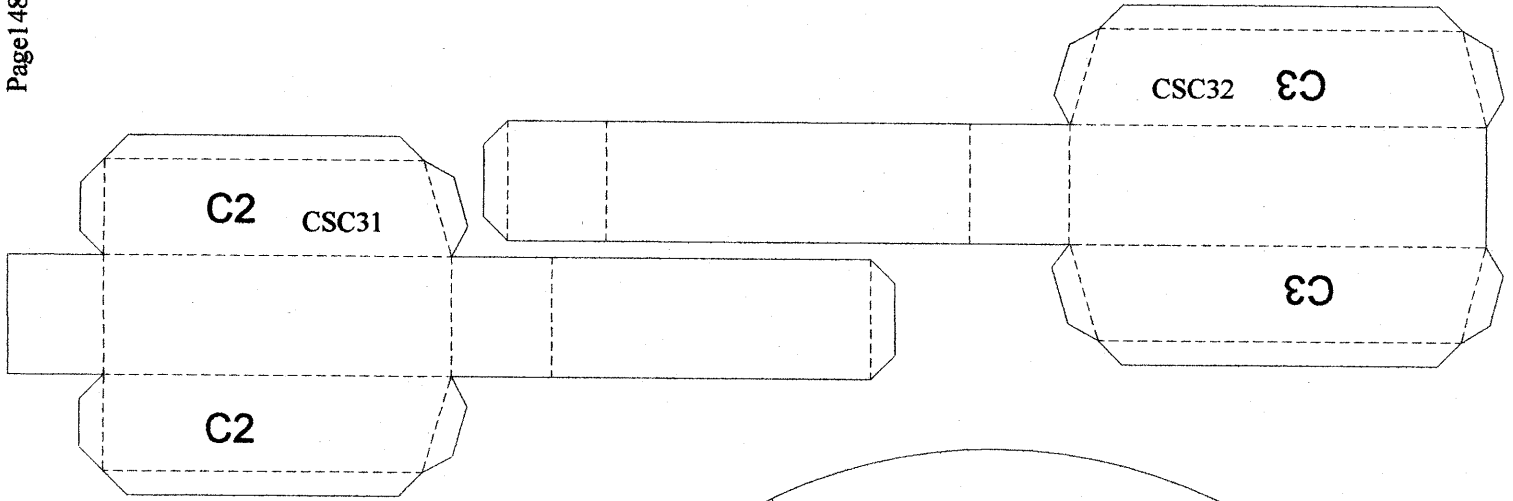

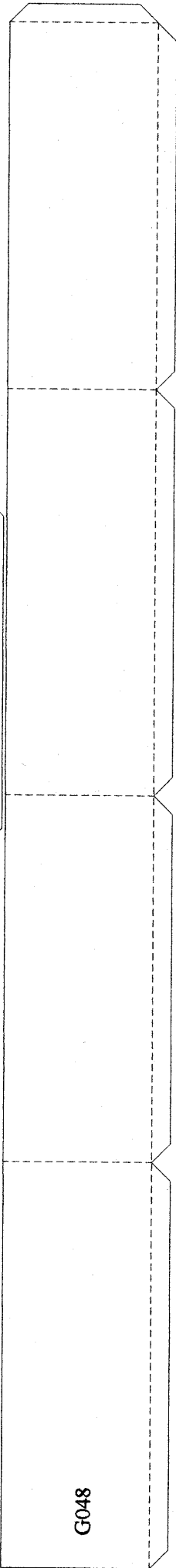
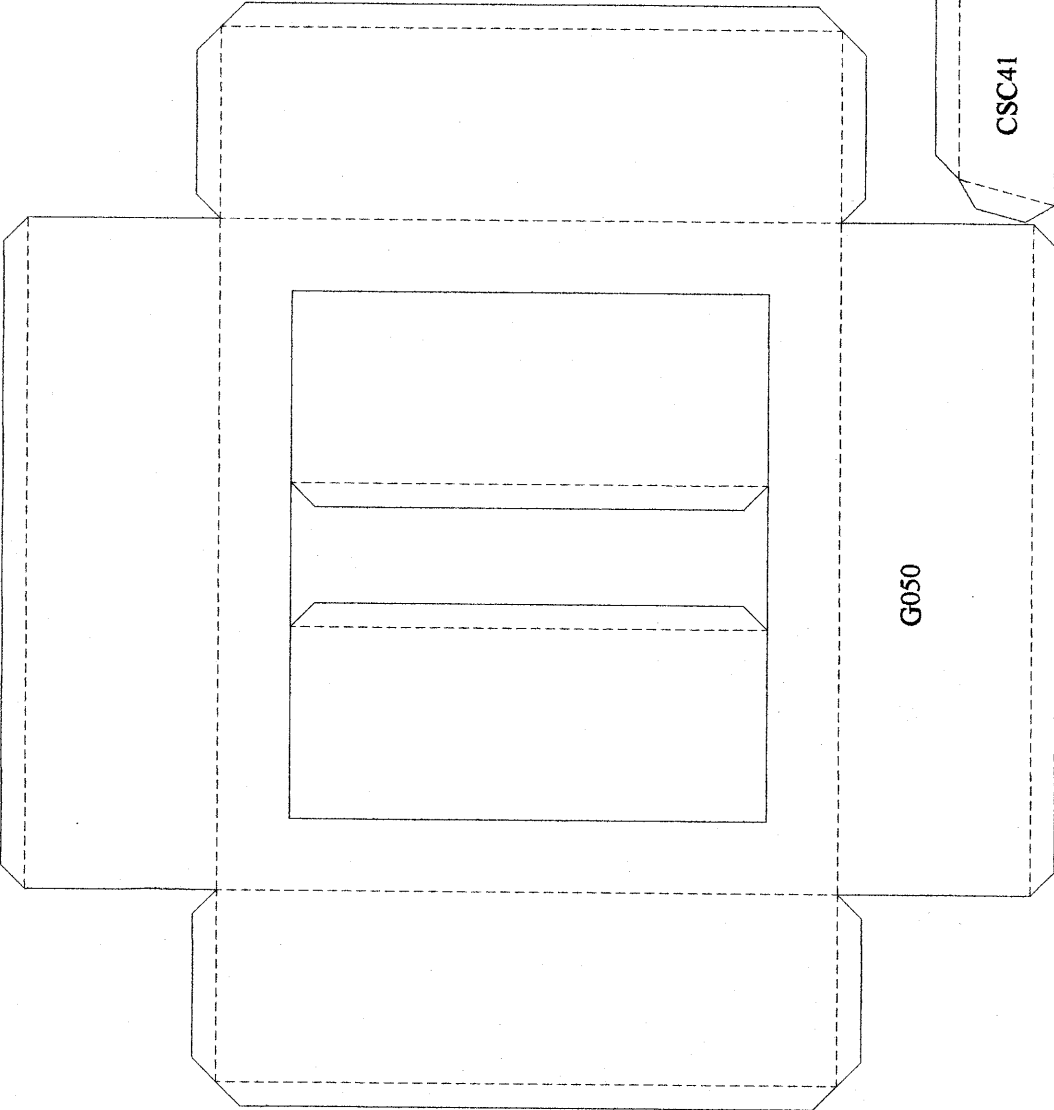
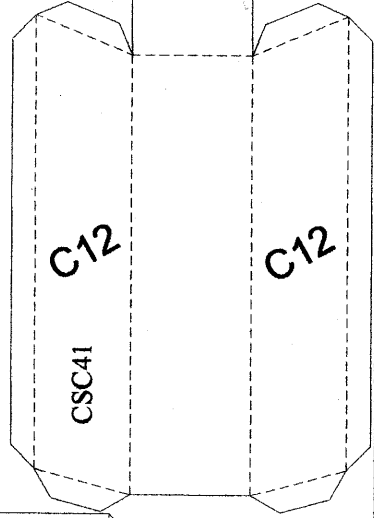
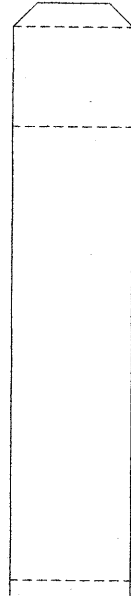
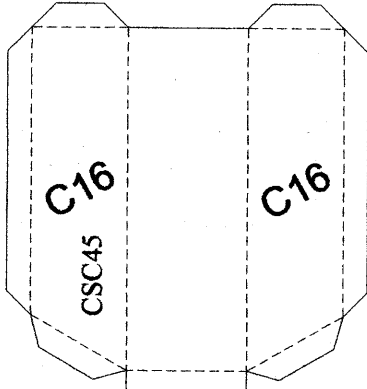
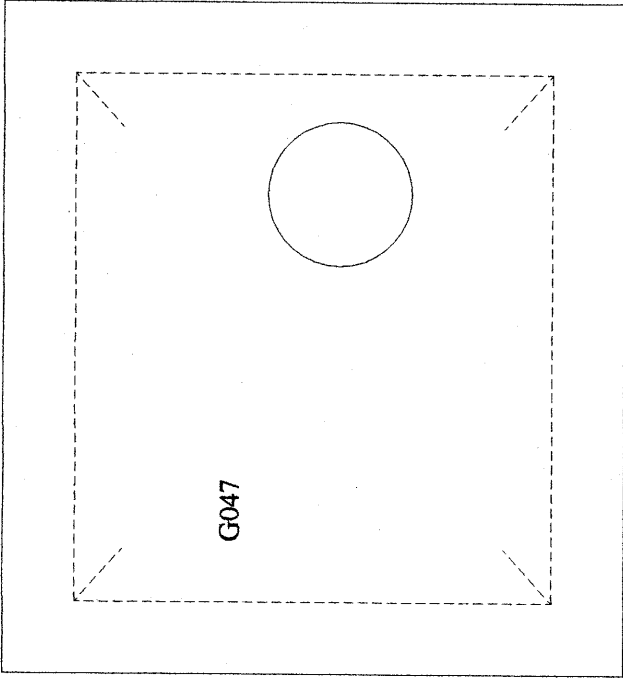

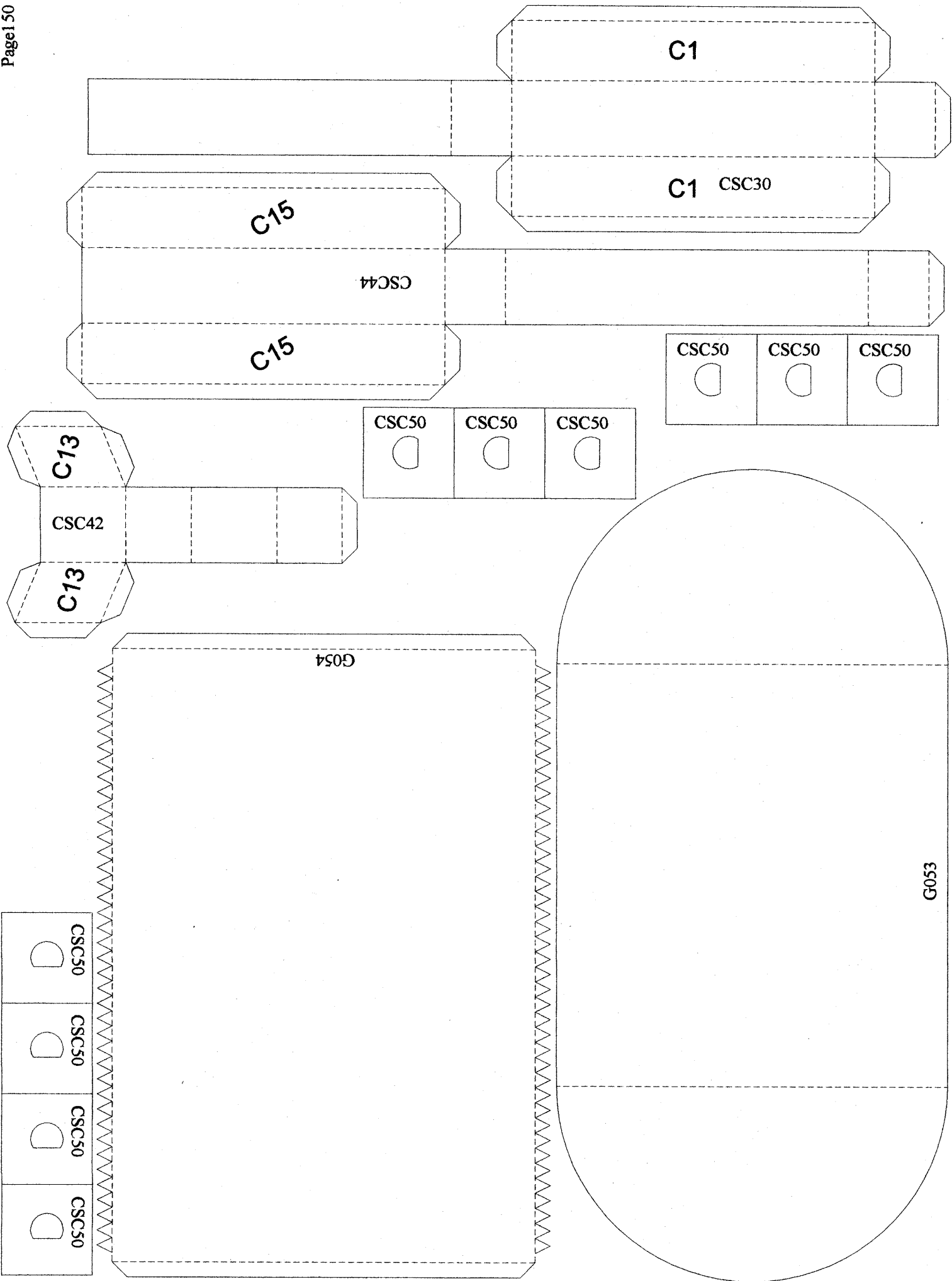

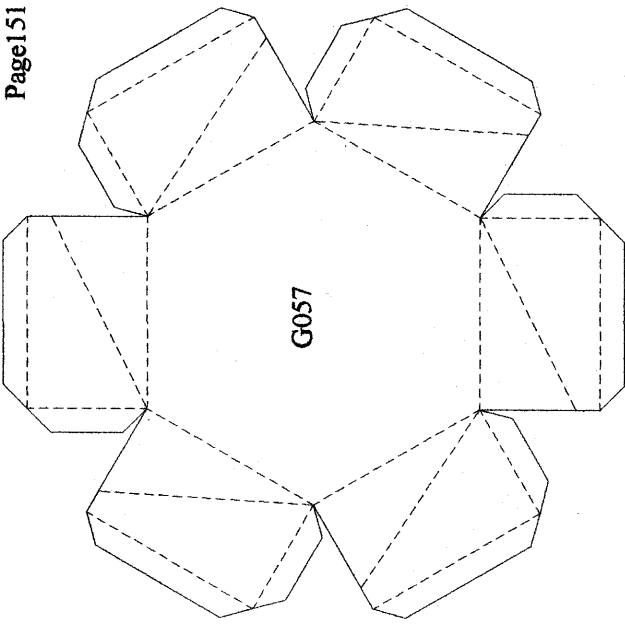

G057

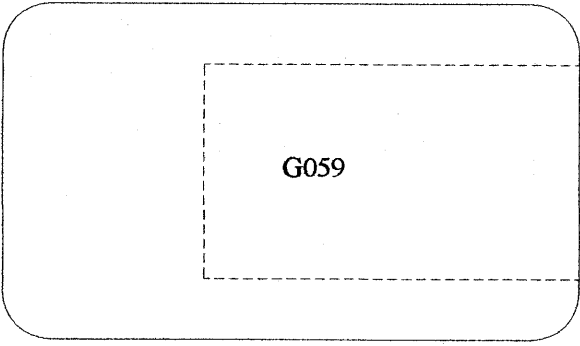

G059

CSC51	CSC51	CSC51	CSC51	CSC51	CSC51	CSC51	CSC51	CSC51
<input type="checkbox"/>	<input type="checkbox"/>	<input type="checkbox"/>	<input type="checkbox"/>	<input type="checkbox"/>	<input type="checkbox"/>	<input type="checkbox"/>	<input type="checkbox"/>	<input type="checkbox"/>

CSC51	CSC52	CSC51	CSC51
<input type="checkbox"/>	<input type="checkbox"/>	<input type="checkbox"/>	<input type="checkbox"/>

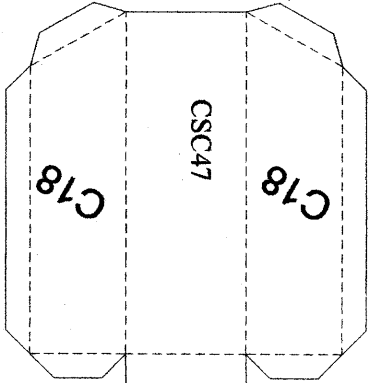

C18

CSC47

C18

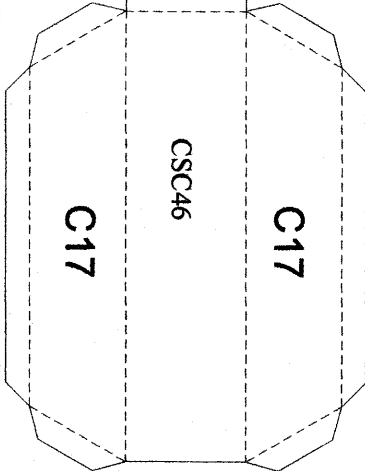

C17

CSC46

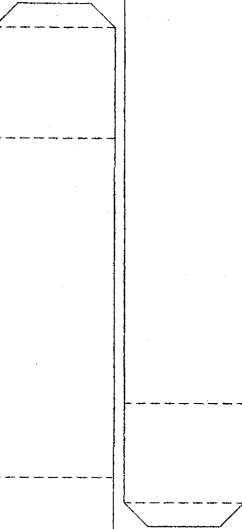

C11

CSC40

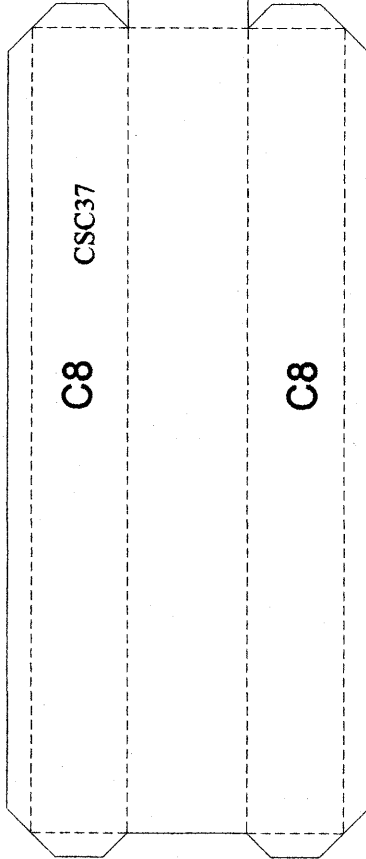

C8

CSC37

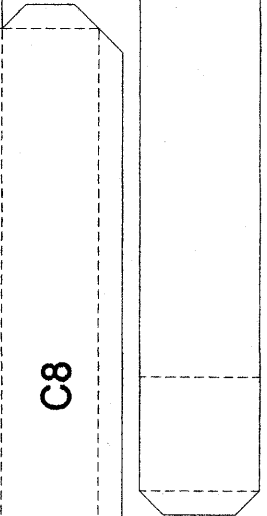

C9

CSC35

C9

CSC53	CSC53	CSC53	CSC53
-------	-------	-------	-------

C9

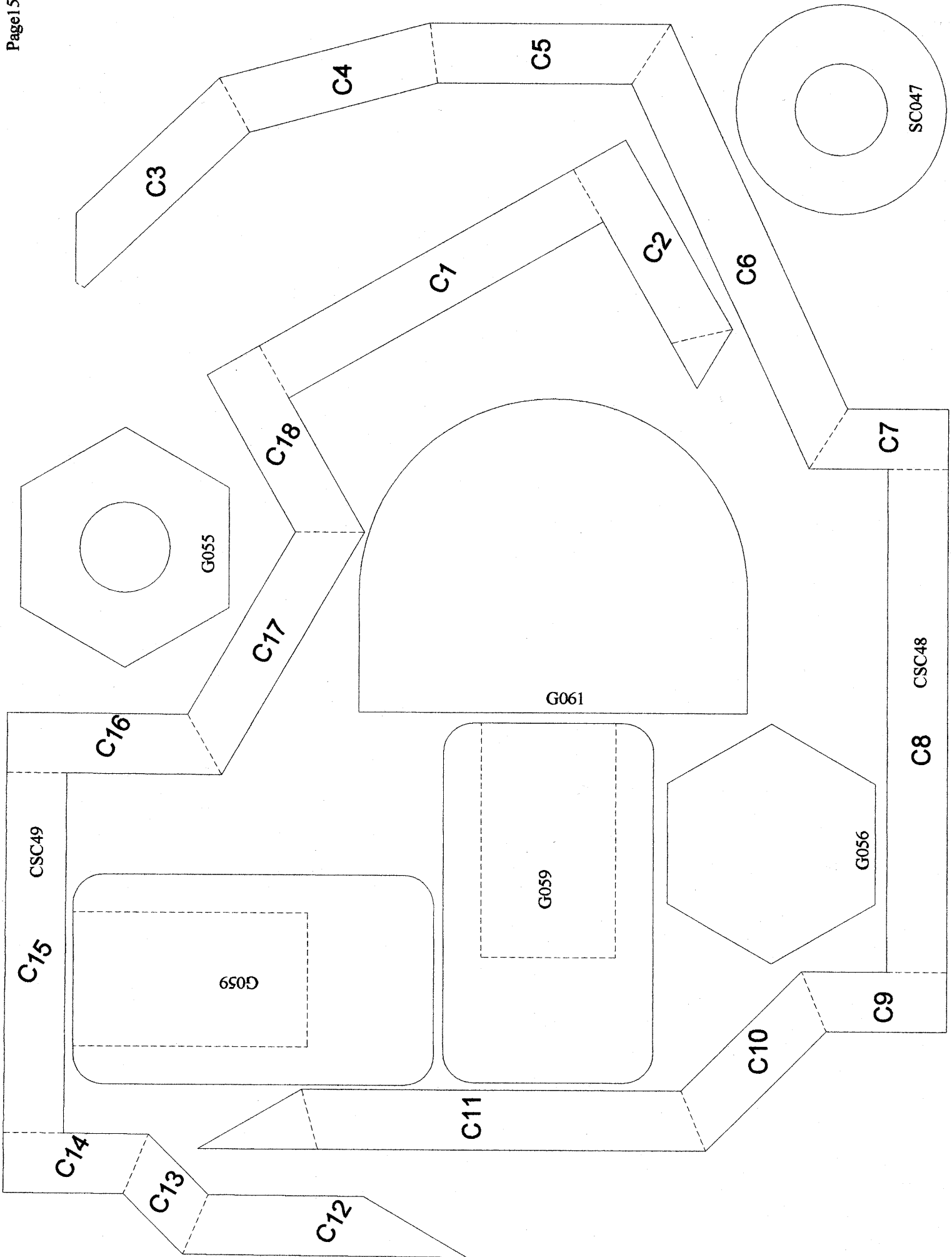

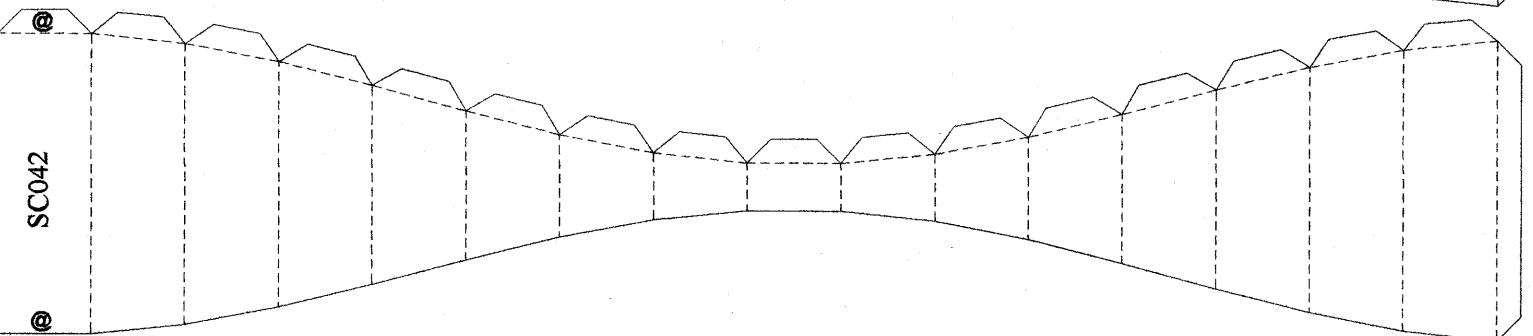
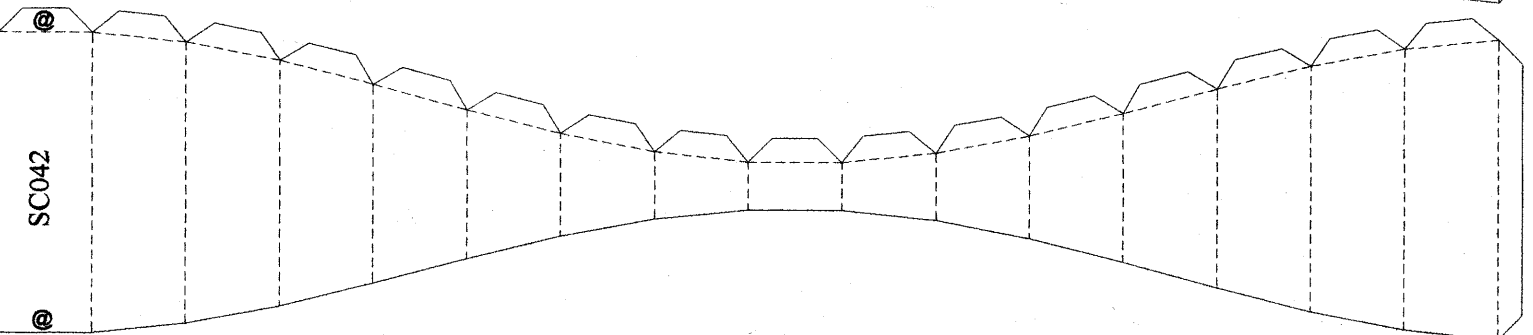
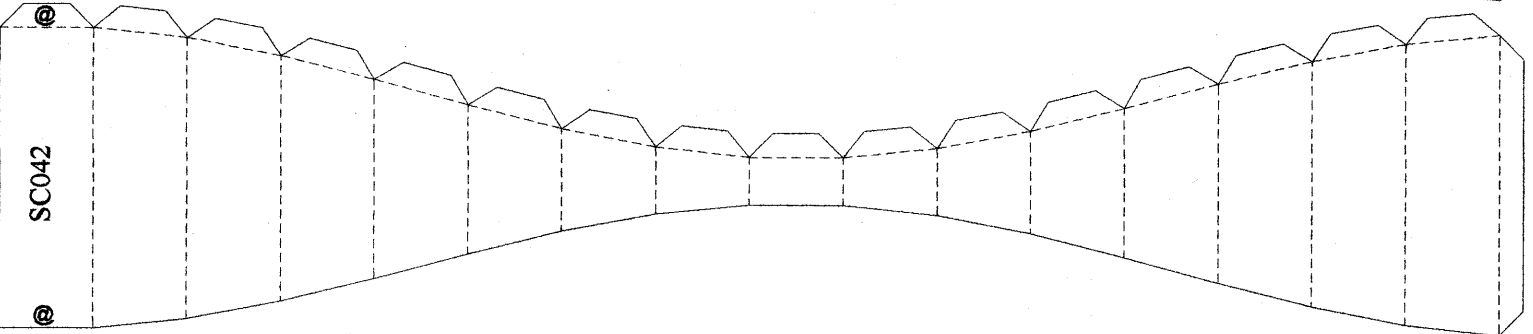
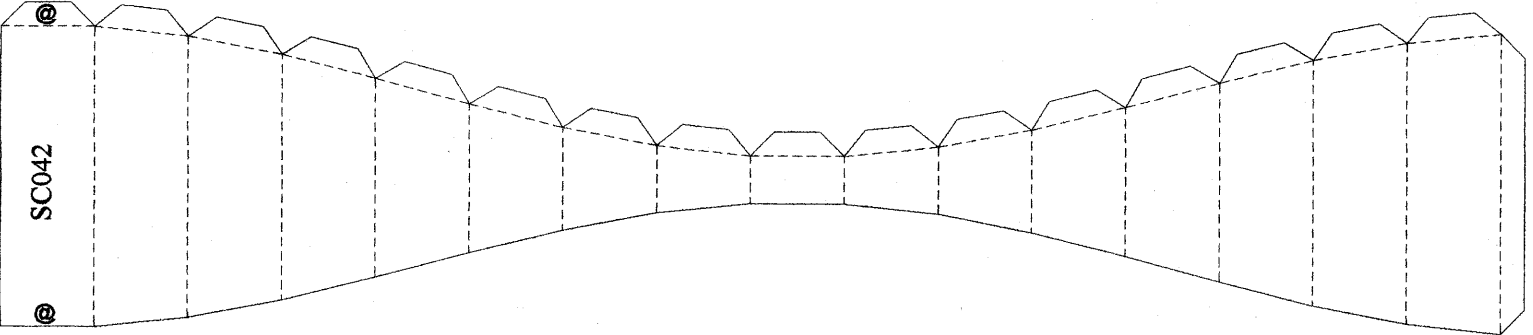
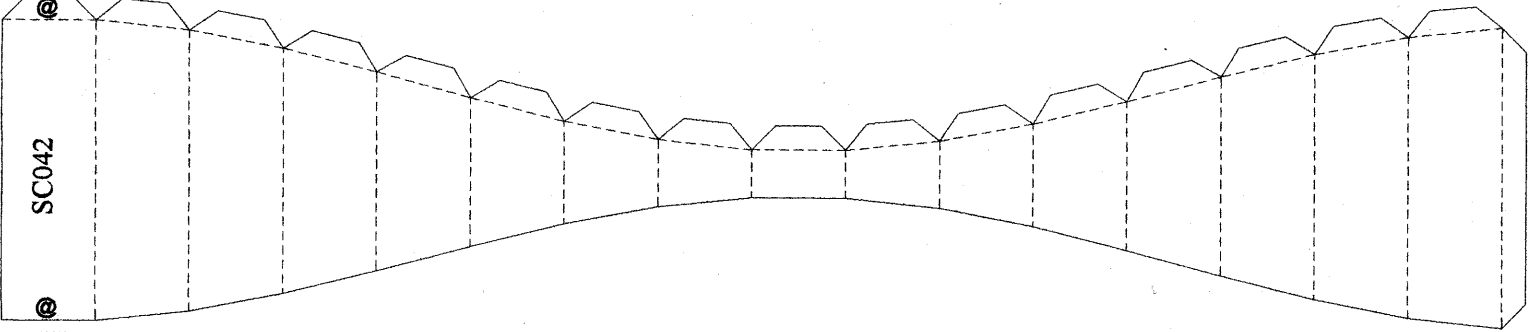
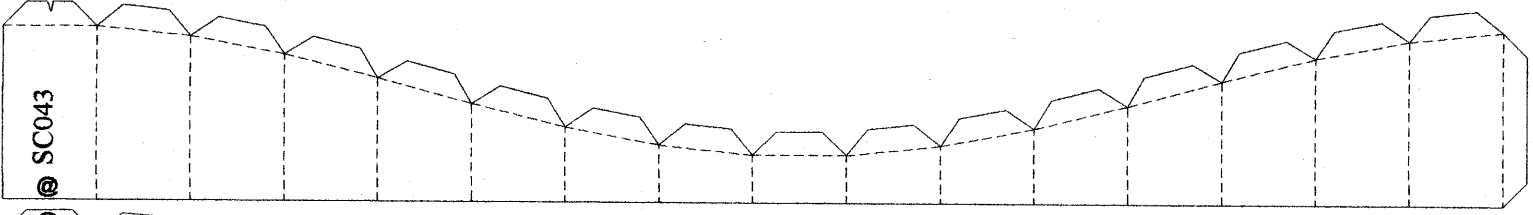

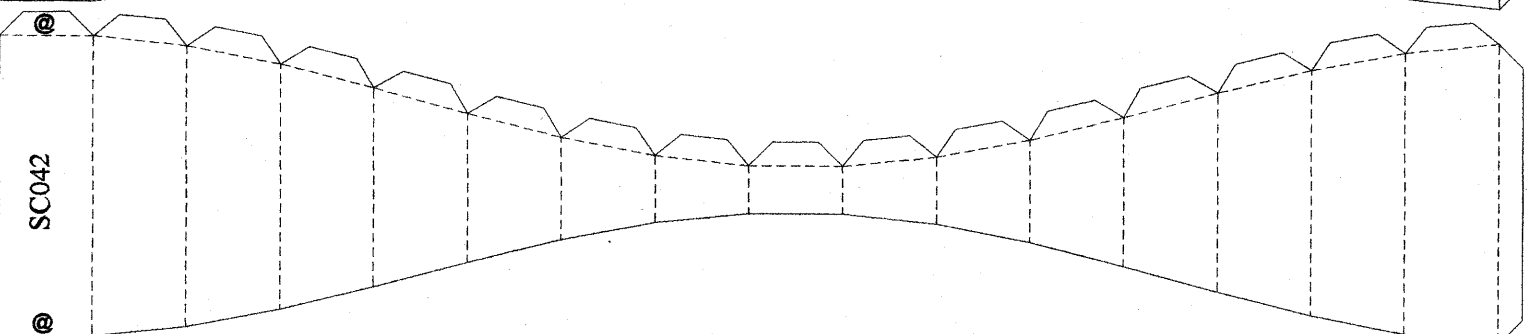
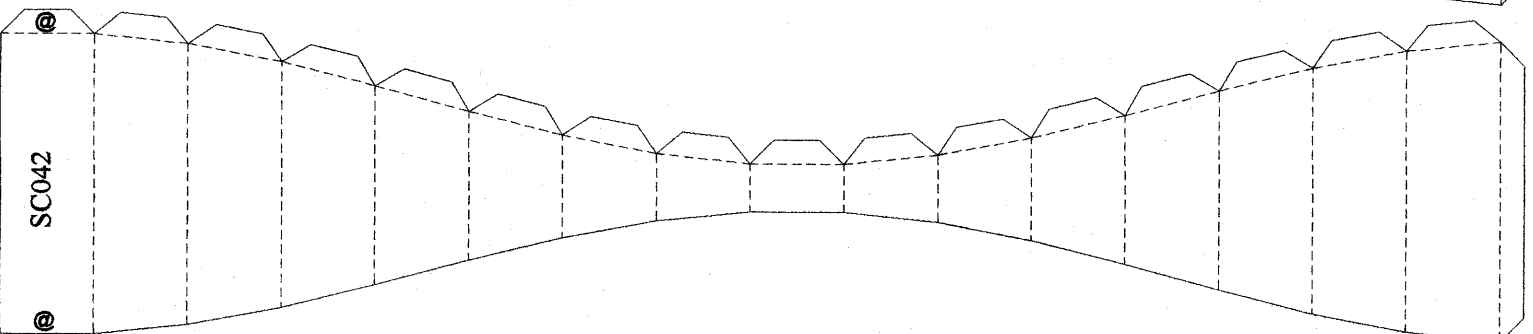
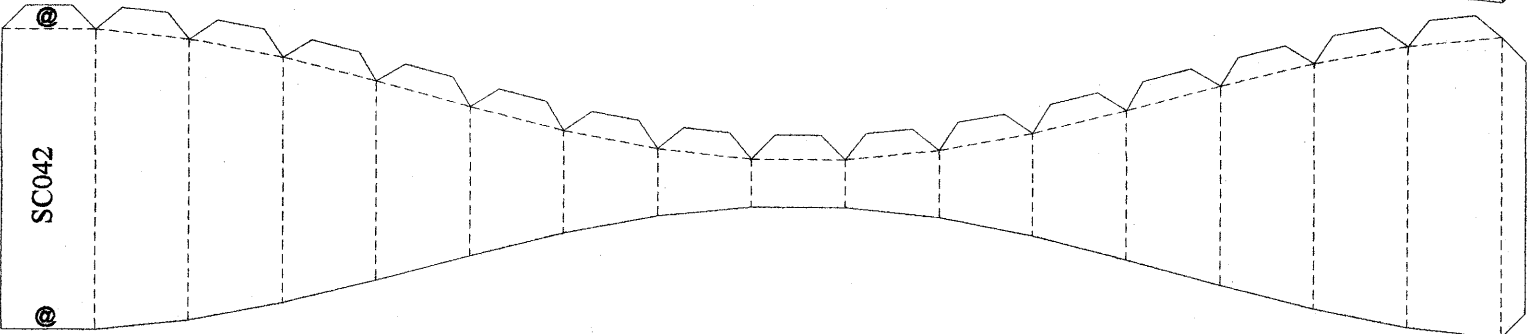
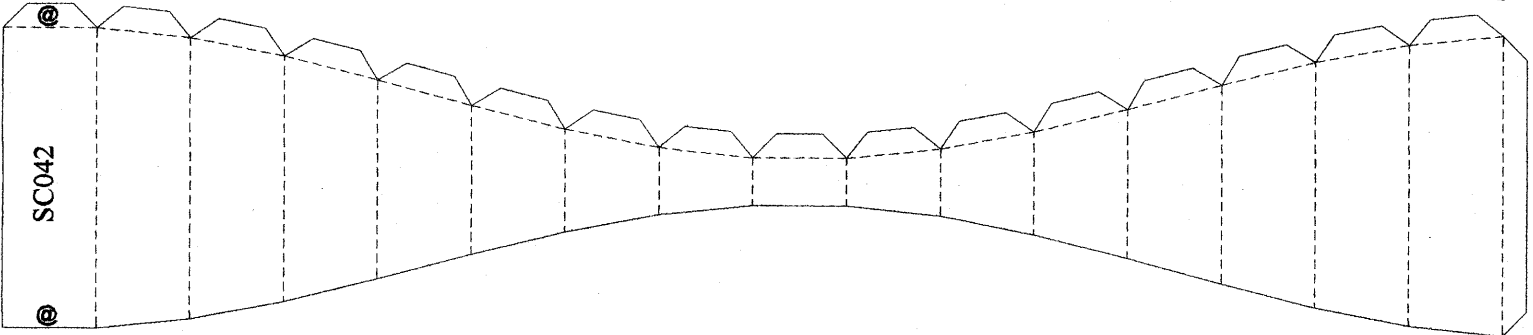
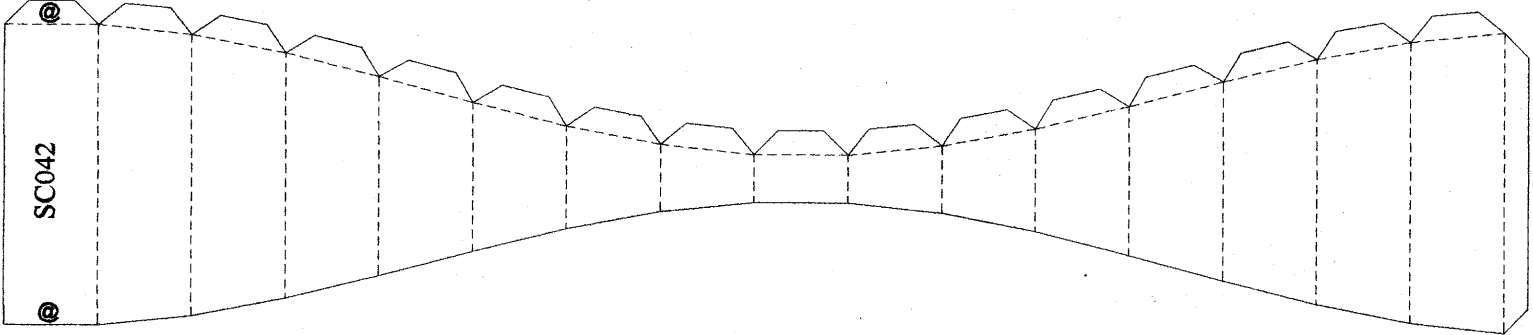
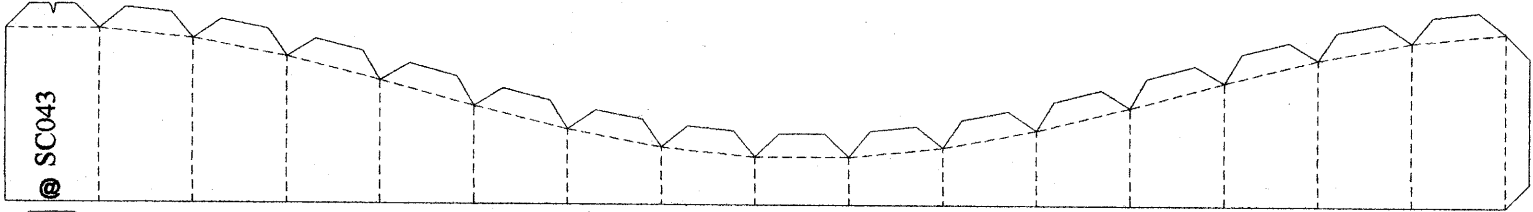

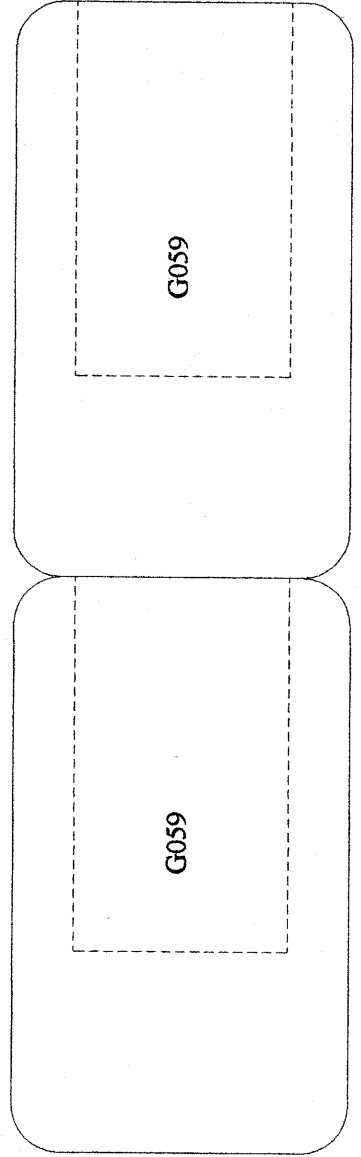
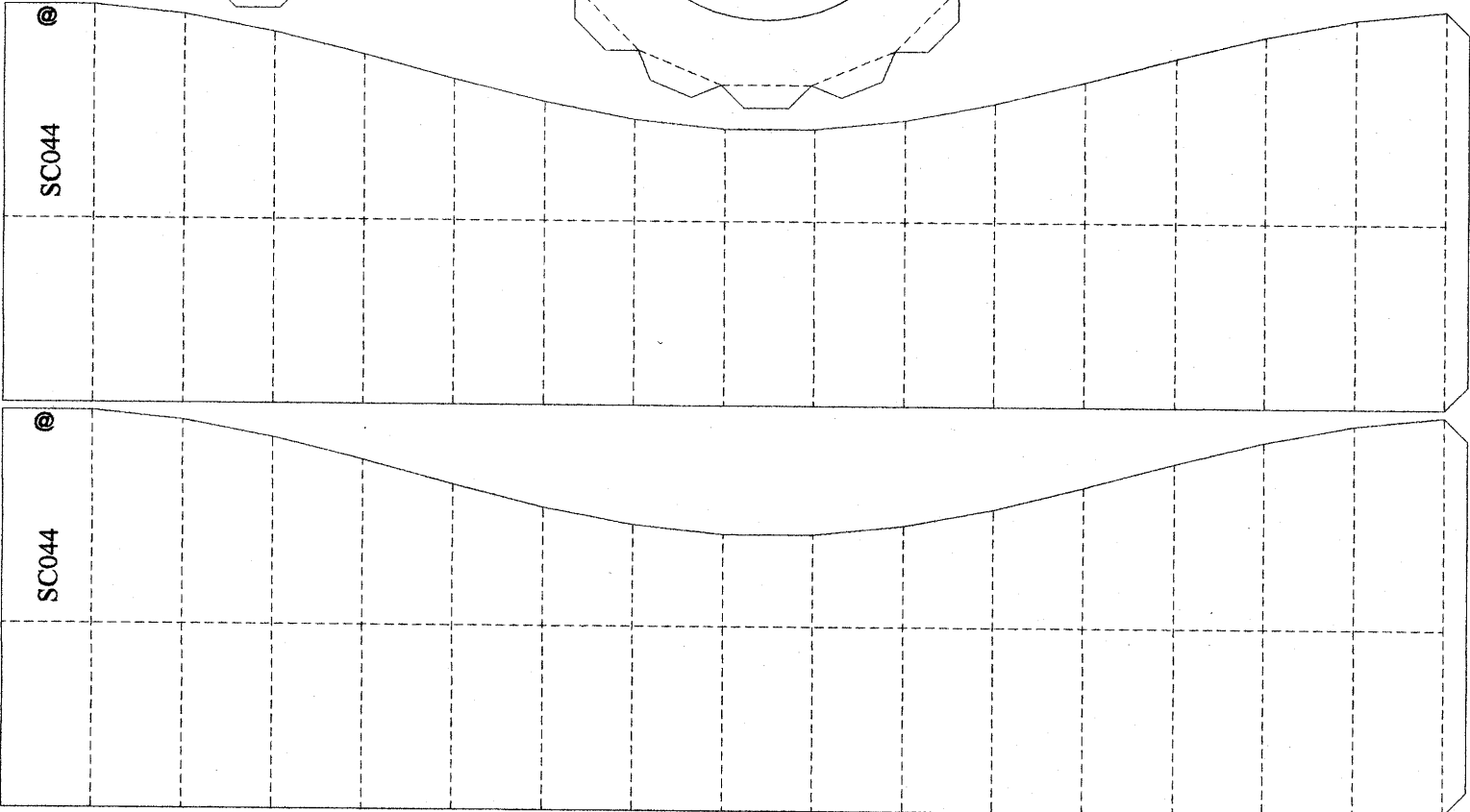
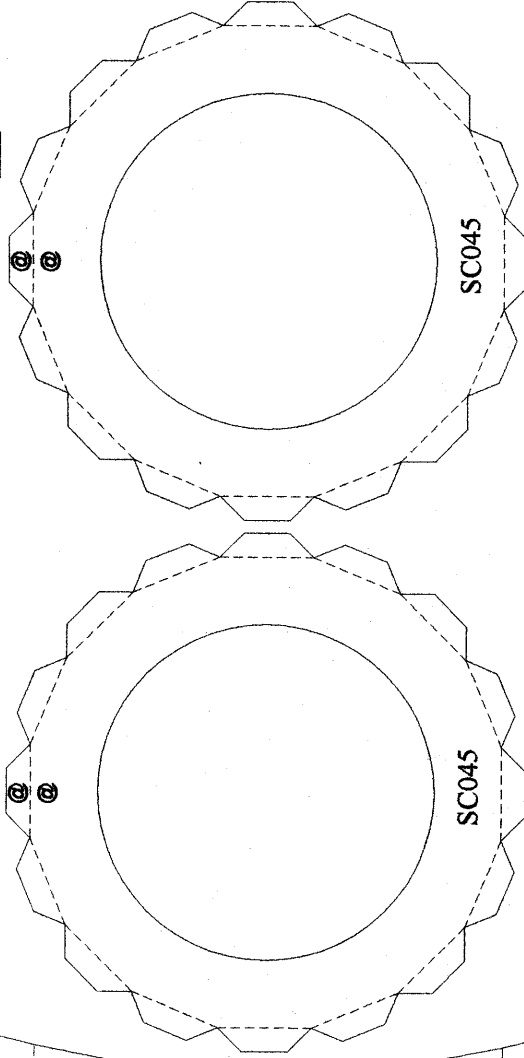
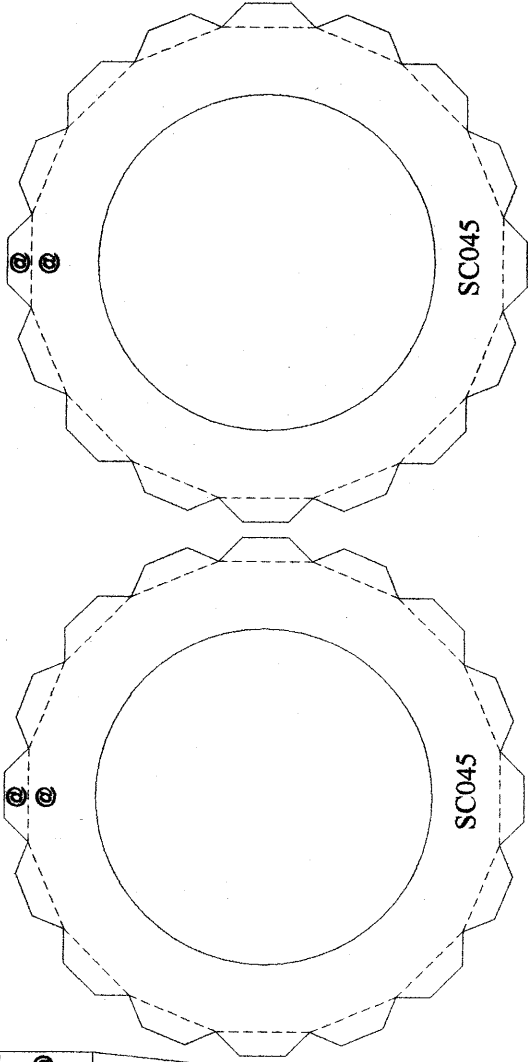



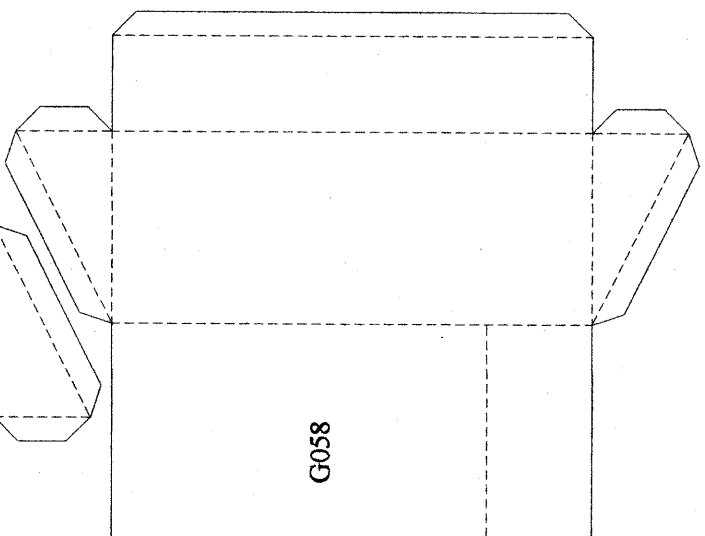
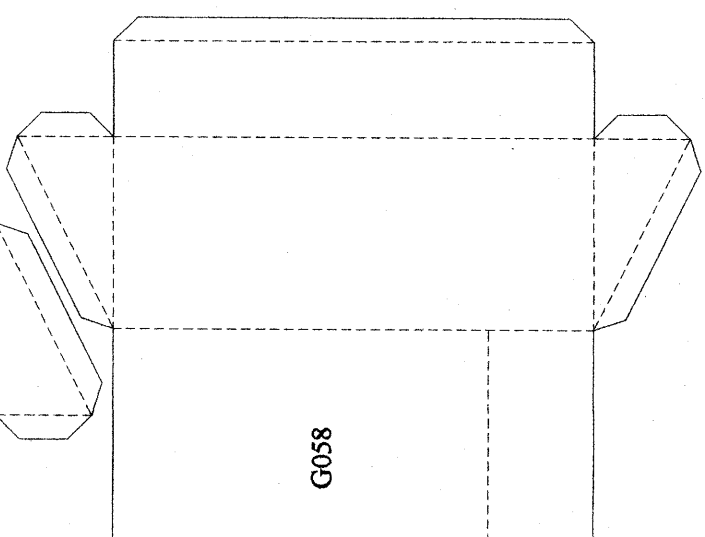
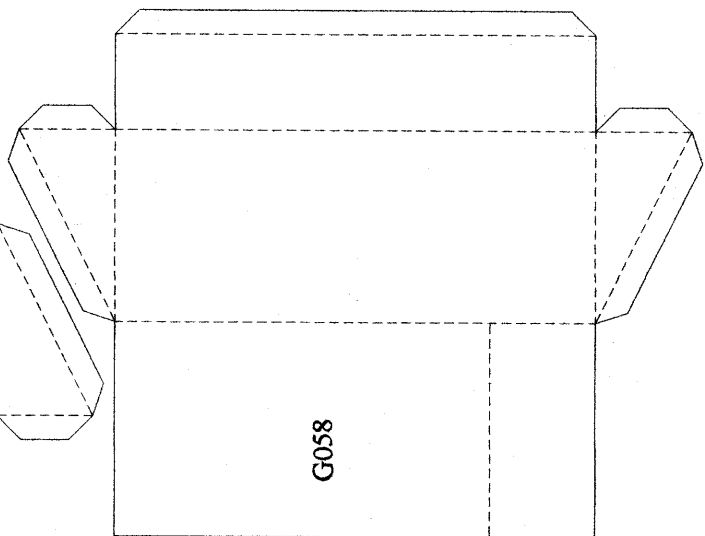
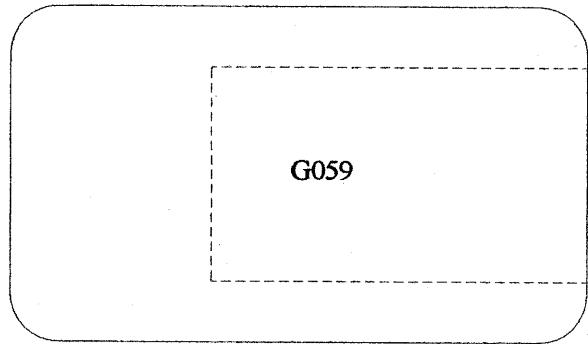
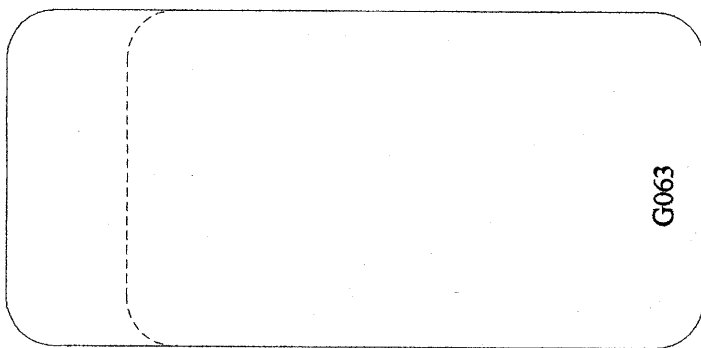
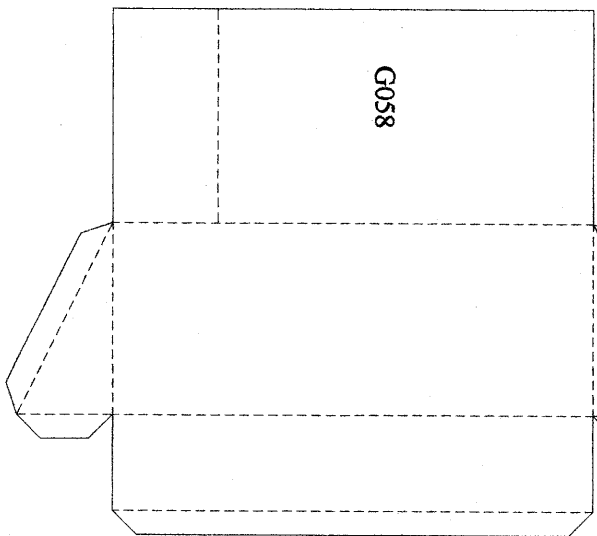
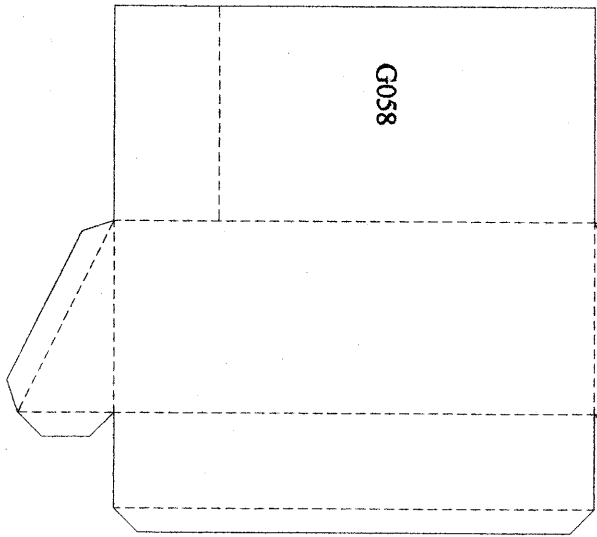
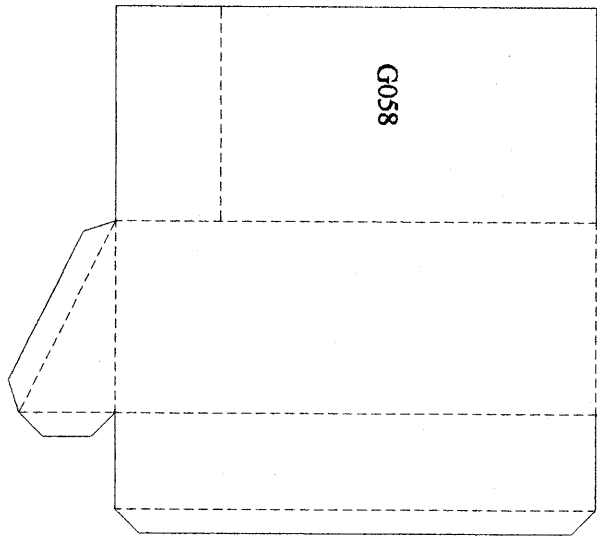
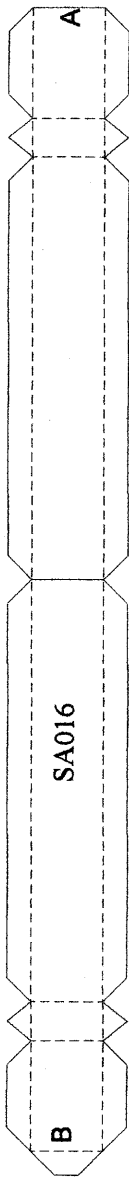

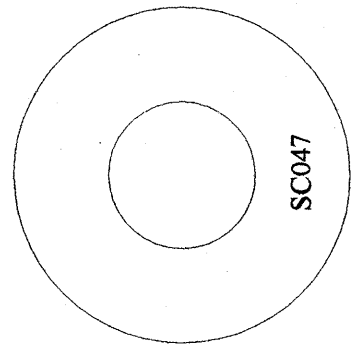
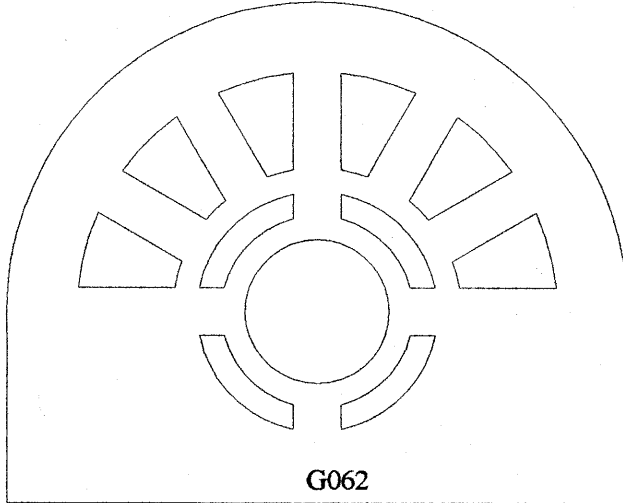
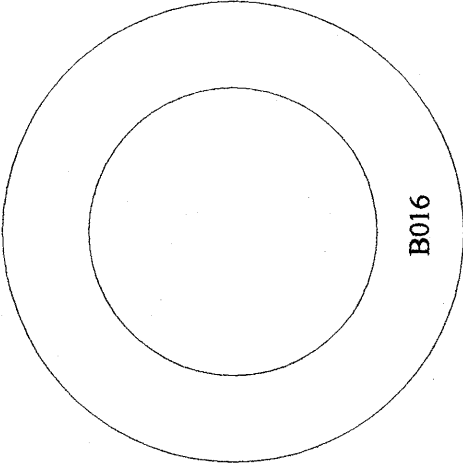
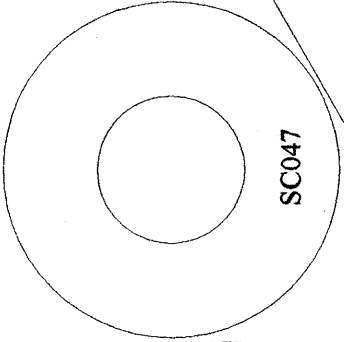
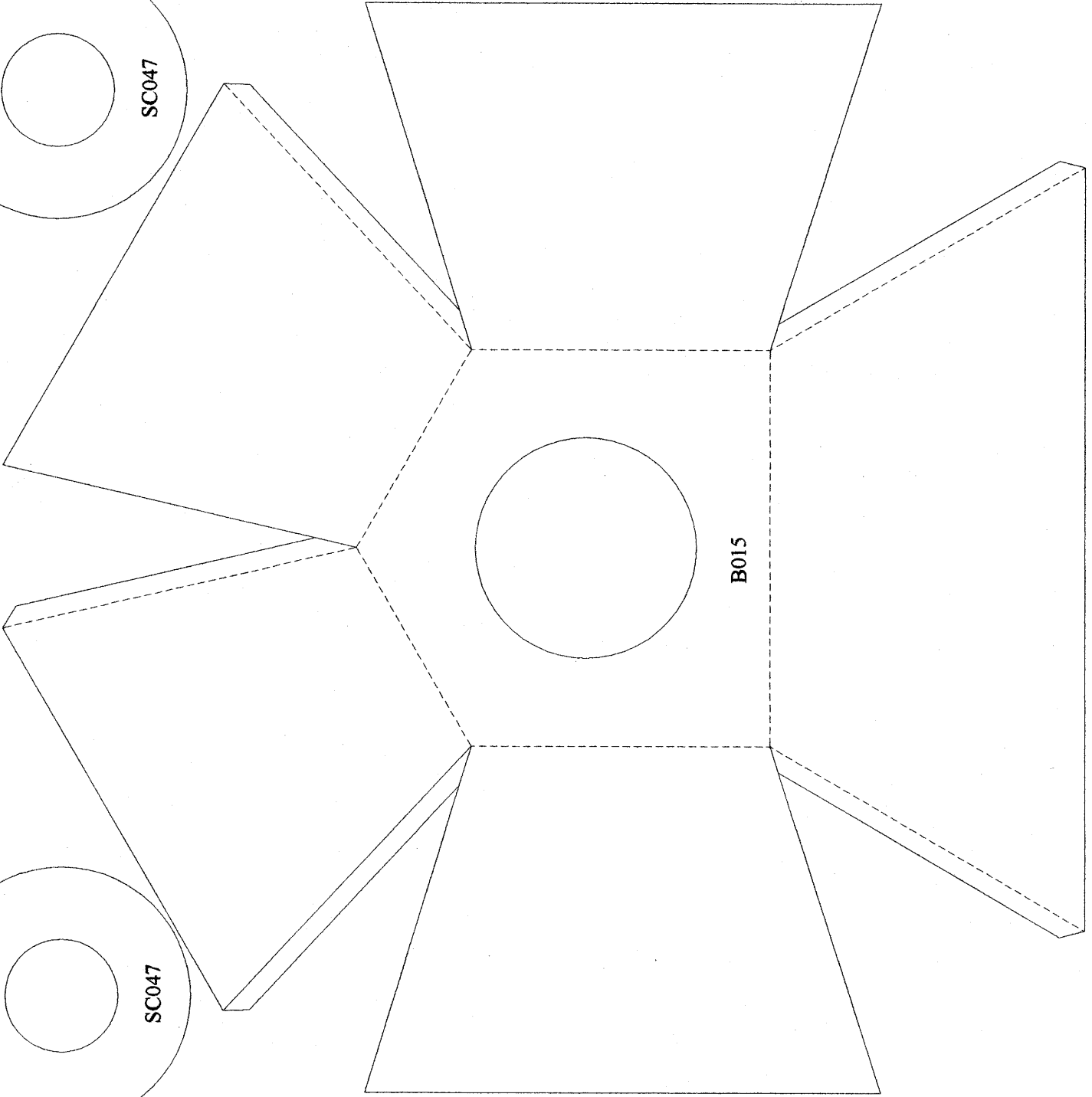
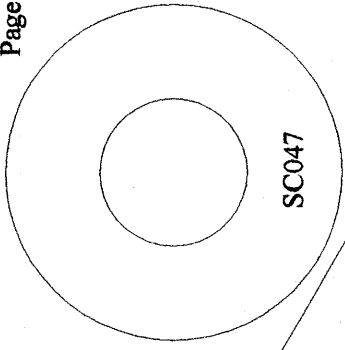

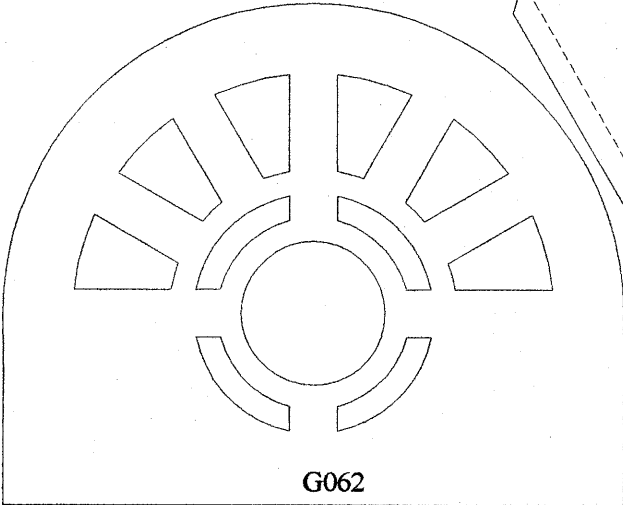
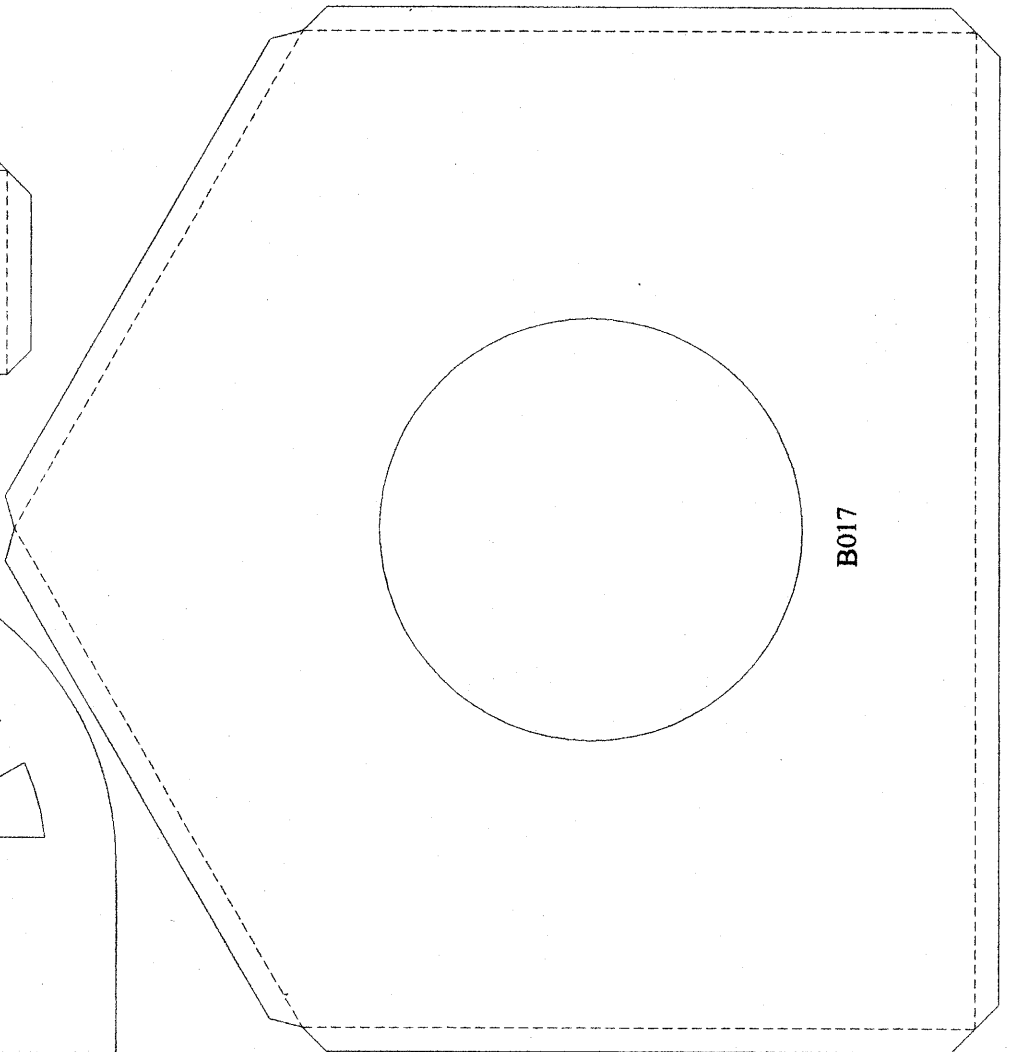
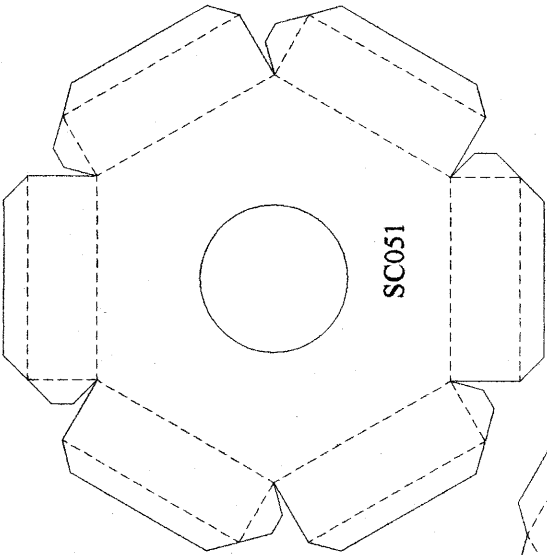
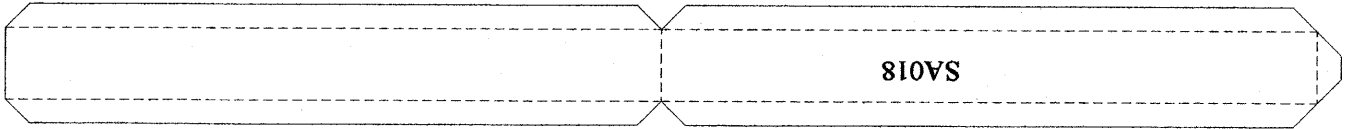
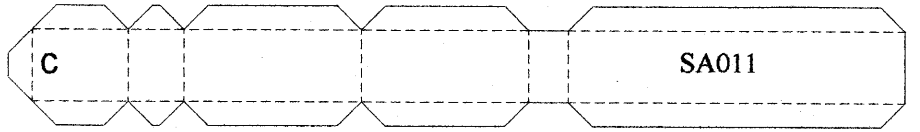
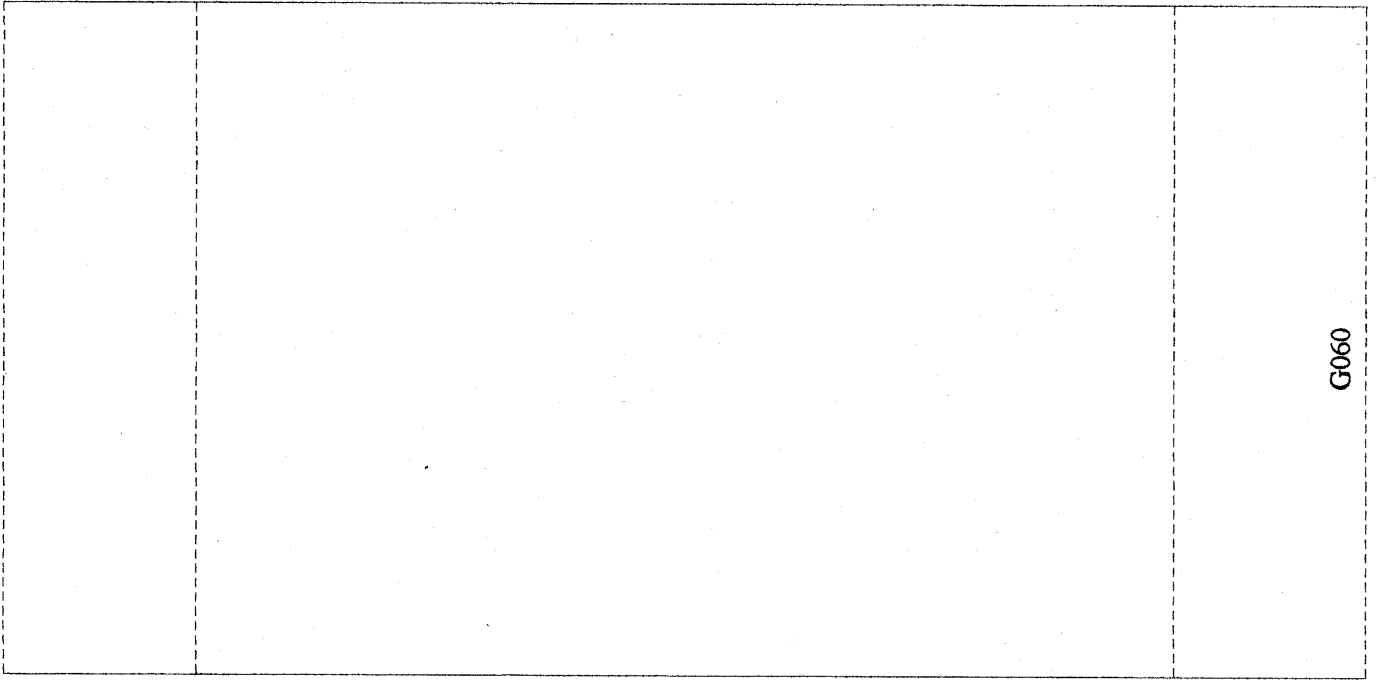

G060

C

SA011

SA018

SC051

B017

G062

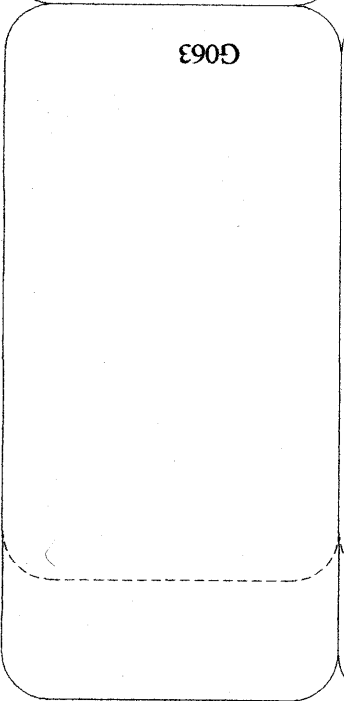
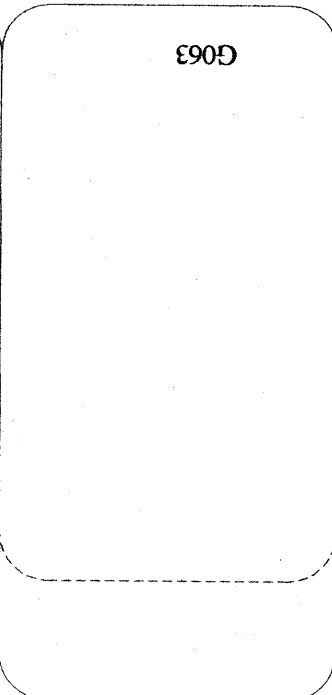
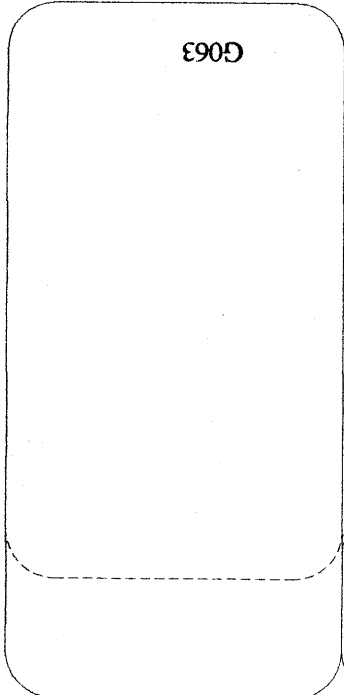
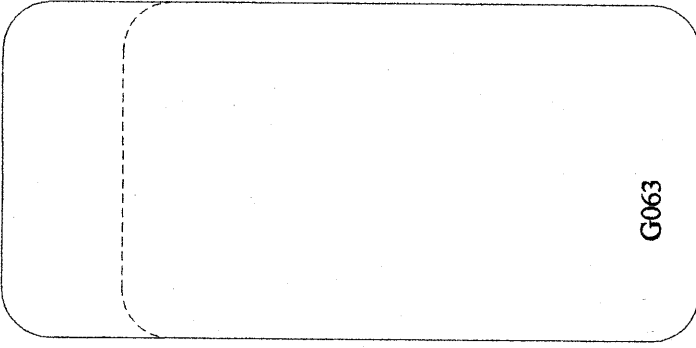
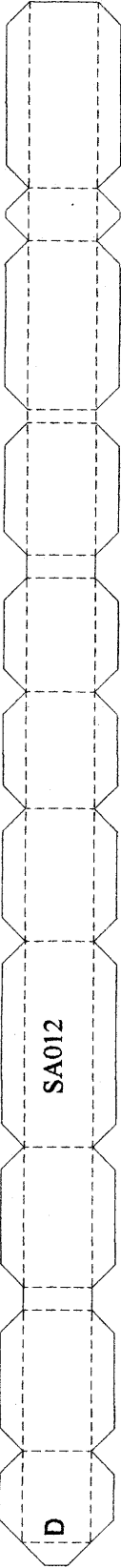

SC050
SC050
SC050
SC050

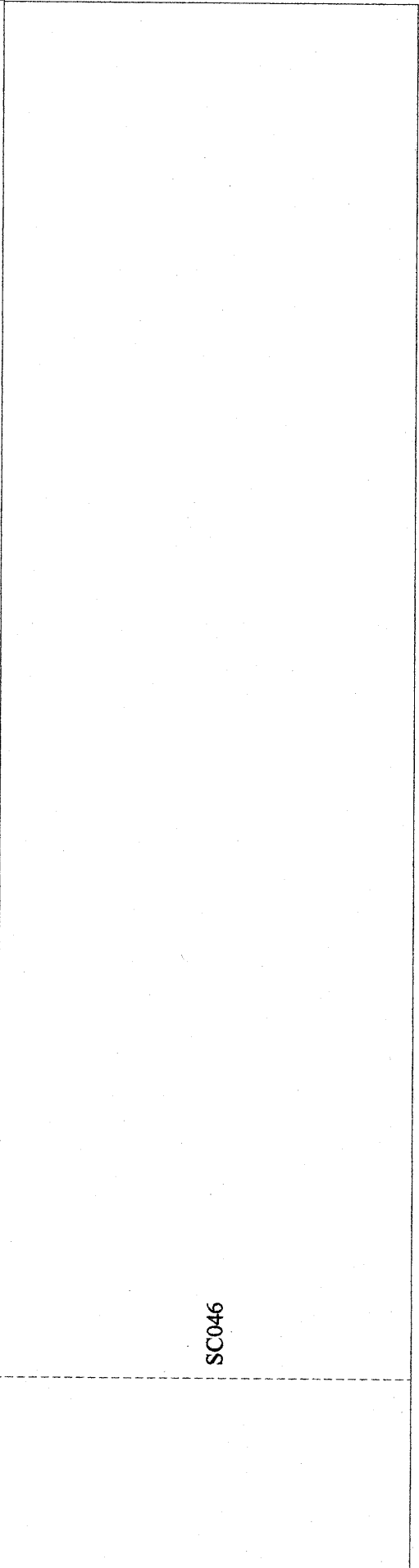

SCA16

SCA16

SCA16

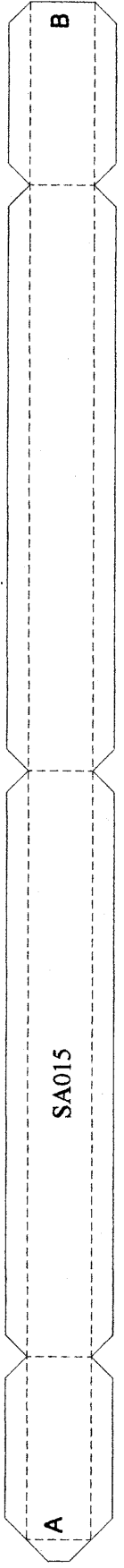
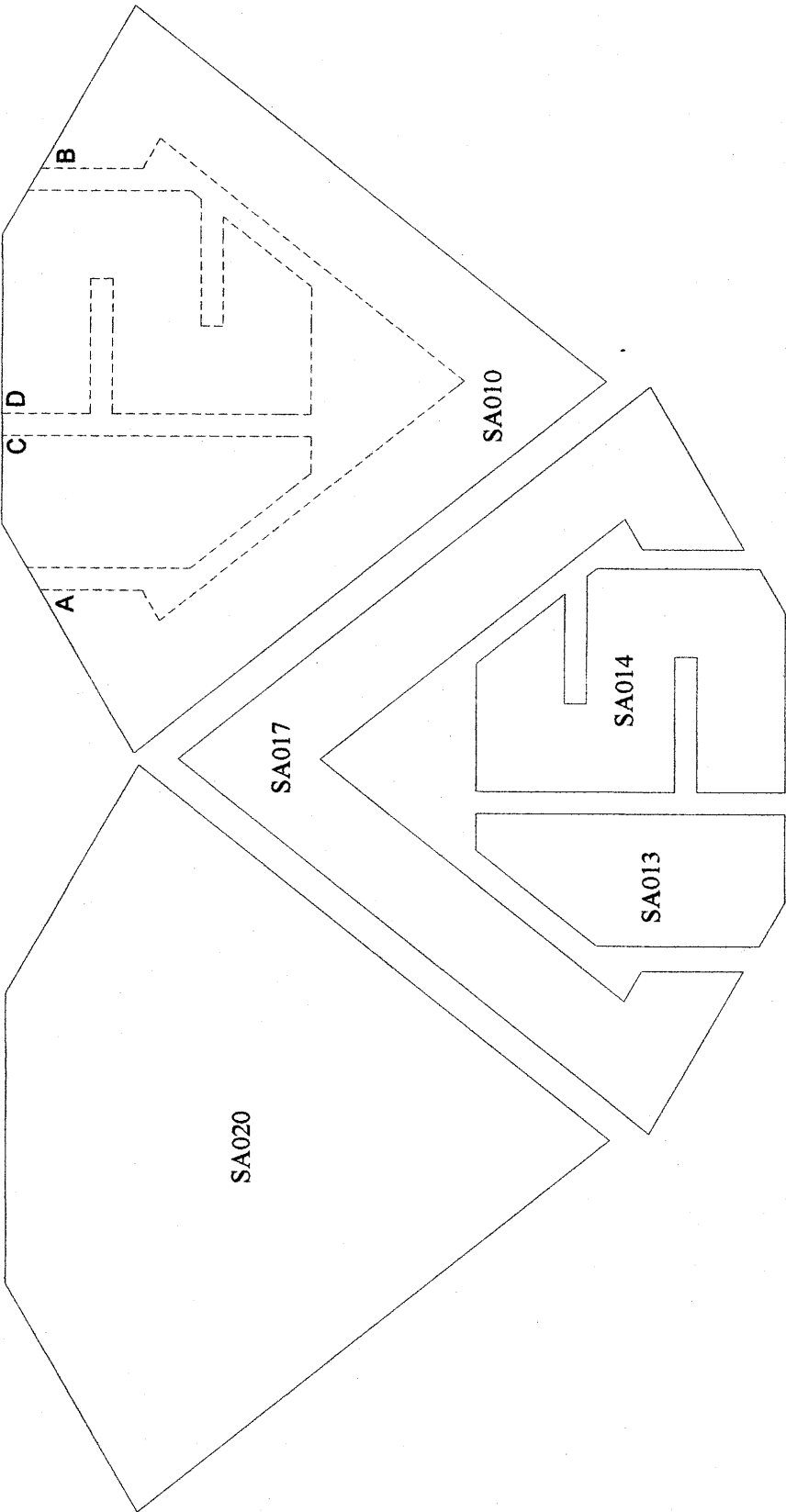
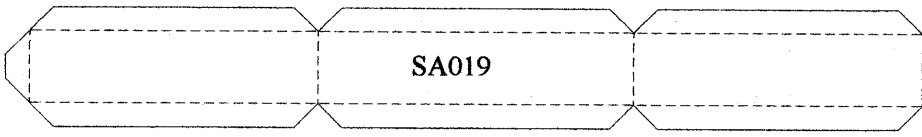







CSB03

R010

R010

R010

R010

R010

R010

R010

R010

R010

R010

R010

R010

P007
P007
P007
P007
P007
P007

P007

P007

P007

P007

P007

P009	P009	P009	P009		P007		P007
------	------	------	------	--	------	--	------























P009a	P009a	P009a	P009a
-------	-------	-------	-------

P009a	P009a	P009a	P009a	P009a
-------	-------	-------	-------	-------



P009a	P009a	P009a	P009a	P009a
-------	-------	-------	-------	-------





CS12	CS12	CS12
------	------	------

CS12	CS12	CS12
------	------	------

CS13	CS13	CS13
CS13	CS13	CS13

CSA04	CSA04	CSA04	CSA04
-------	-------	-------	-------

CSA04	CSA04	CSA04	CSA04
-------	-------	-------	-------



CSA04	CSA04	CSA04	CSA04
-------	-------	-------	-------

CSA04	CSA04	CSA04	CSA04
-------	-------	-------	-------

CSB03	CSB03	CSB03
-------	-------	-------

CSC03	CSC03	CSC03	CSC03	CSC03
-------	-------	-------	-------	-------

CSC03	CSC03	CSC03
-------	-------	-------

G046	G046	G046
------	------	------

SC048

SC048

SC048

SCA17

SCA17

SCA17