

# BMW 315 Sport

**Maqueta**

1934

1:24

**KIT**

Recortable  
Cutout  
Découpage  
Ausschneidbar  
Ritagliabili  
Recortável

Design by Alcan

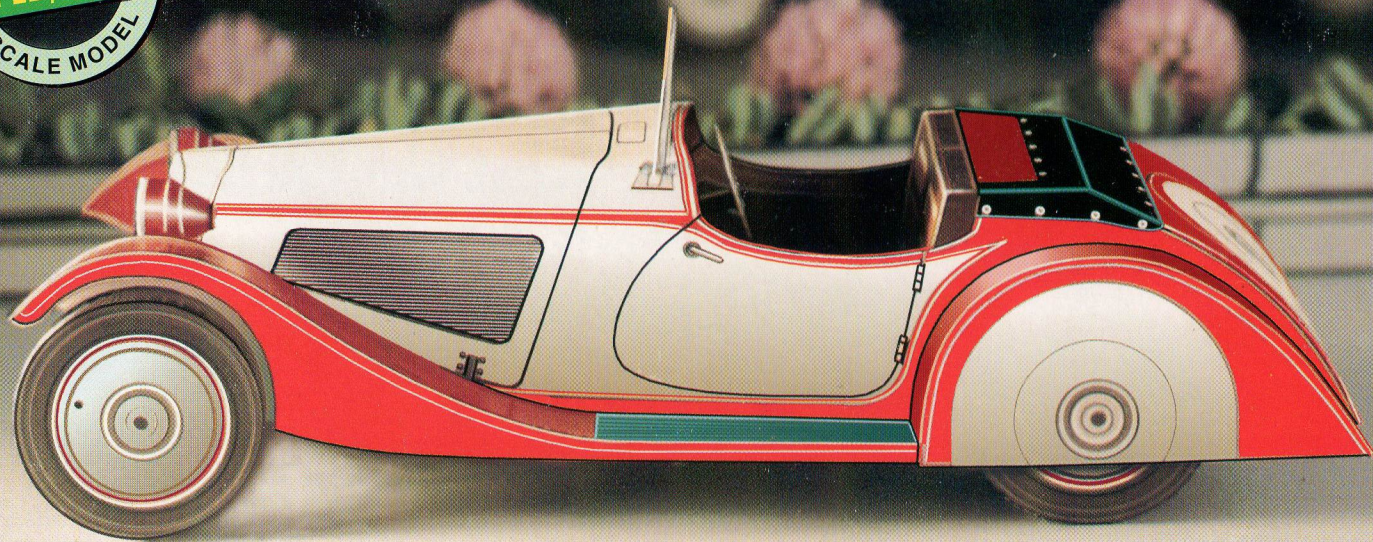

LA MAGIA DEL PAPEL / PAPER MAGIC



CORTAR / CUT / COUPER

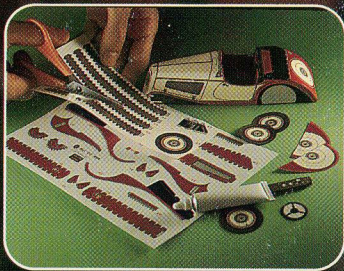

SCHNEIDEN / TAGLIARE

PEGAR / GLUE / COLLER

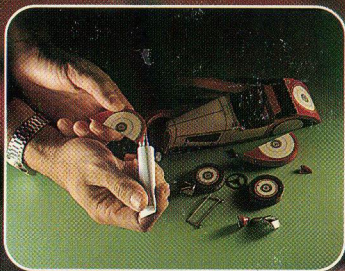

KLEBEN / INCOLLARE

MONTAR / ASSEMBLE / MONTER



ZUSAMMENFUGEN / MONTARE

# BMW 315 Sport

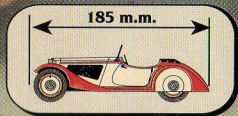
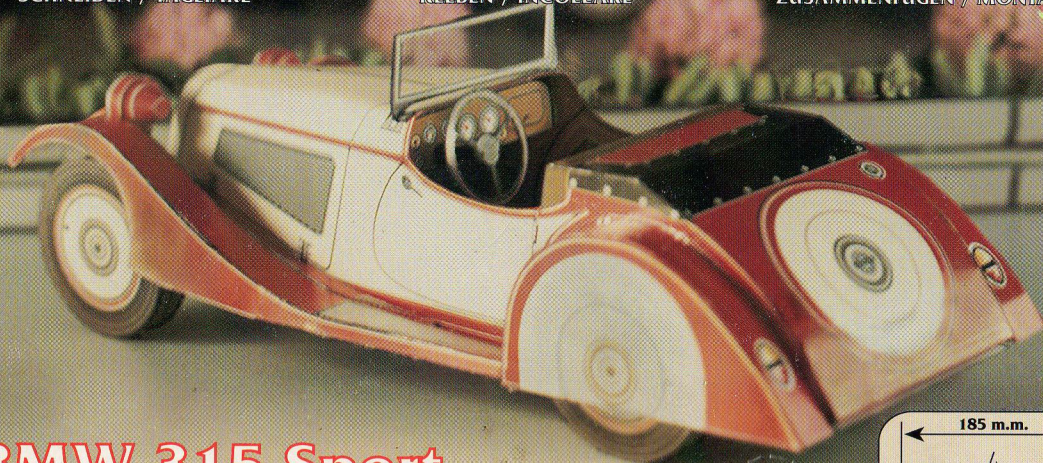

COLECCION / COLLECTION

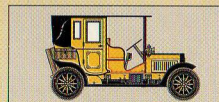

Benz 1905

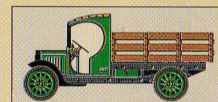

TT-Land 1927

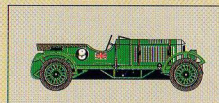

Bentley Lemans 1930

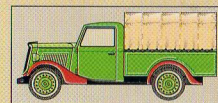

Pick-Up 1936

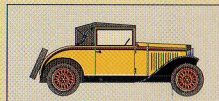

Roadster 1929

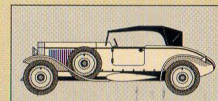

Rolls Royce 1928

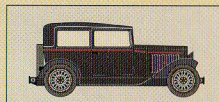

V8 1932

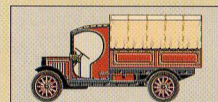

TT 1927

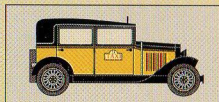

Taxi 1930

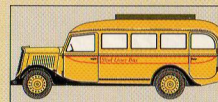

Bus 1936

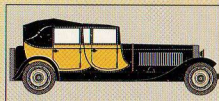

Bugatti Royale 1924

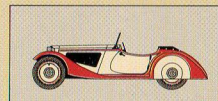

BMW 315 Sport 1934

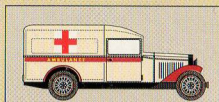

Ambulance 1934

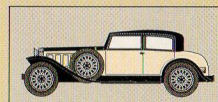

Hispano Suiza Coupe 1934

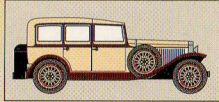

Hispano Suiza 1932

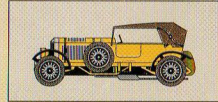

Bentley 1932



© 1993 by ALCAN,S.L.  
Avda. de Vigo, 60 - Alto de Puxeiros  
36416 Puxeiros - MOS (Pontevedra) SPAIN  
Telf.:34 +(9)86 - 48 72 86\*

DESIGNED AND PRINTED IN SPAIN

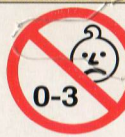

Contiene 47 piezas recortables  
Contains 47 cutout pieces  
Contient 47 pièces découpables  
Enthält 47 ausschneid Teile  
Contiene 47 pezzi ritagliabili  
Contém 47 peças recortáveis



# BMW-315 1936

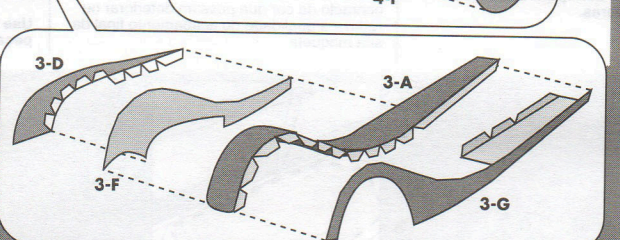
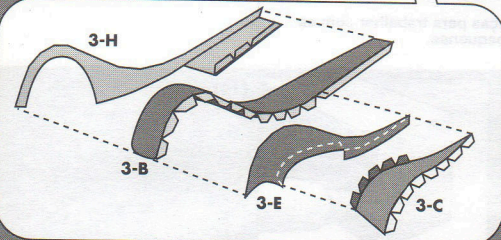
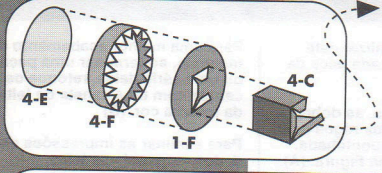
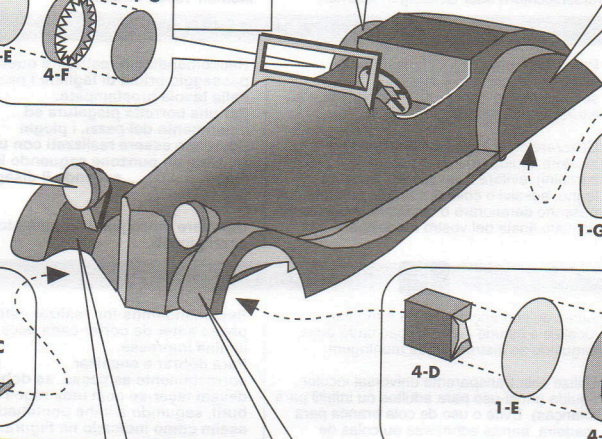
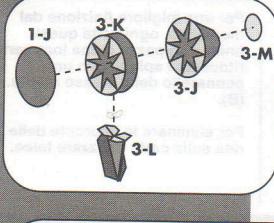
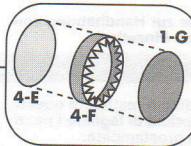
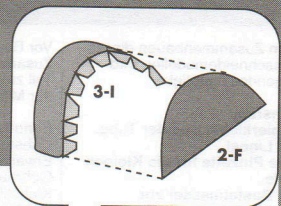
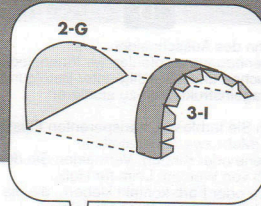
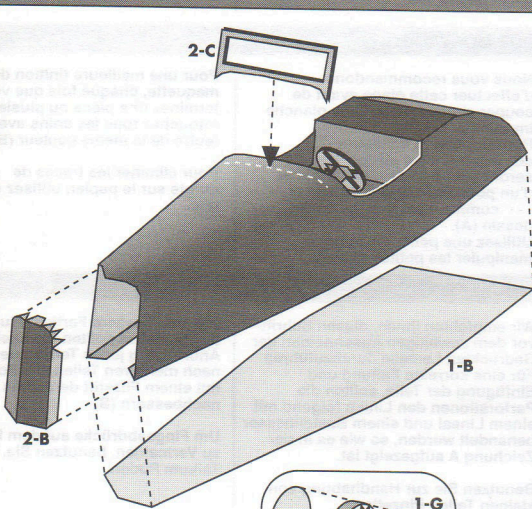
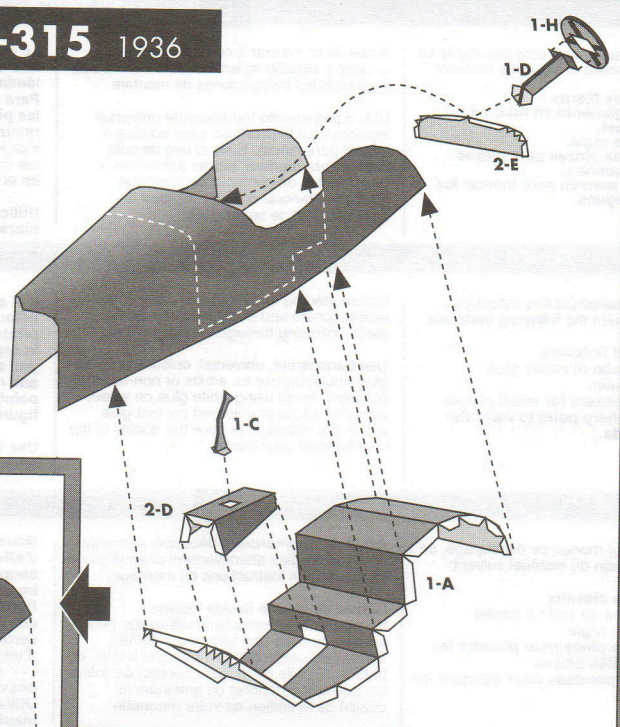
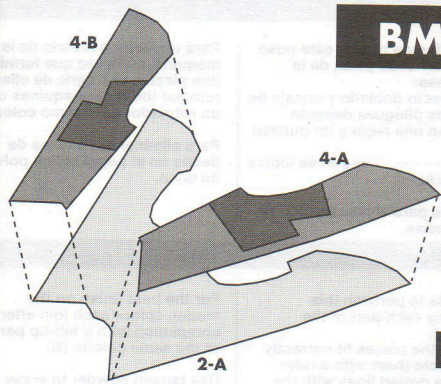



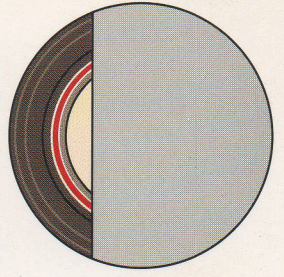

1-G

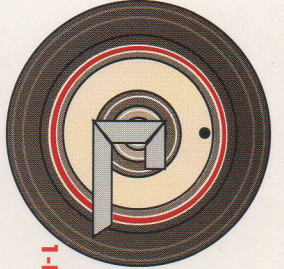
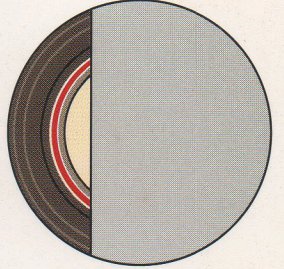

1-F

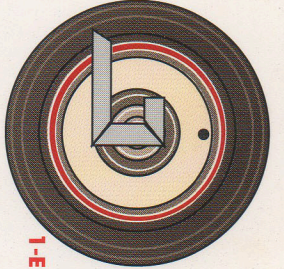

1-E

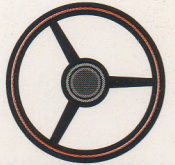

1-H

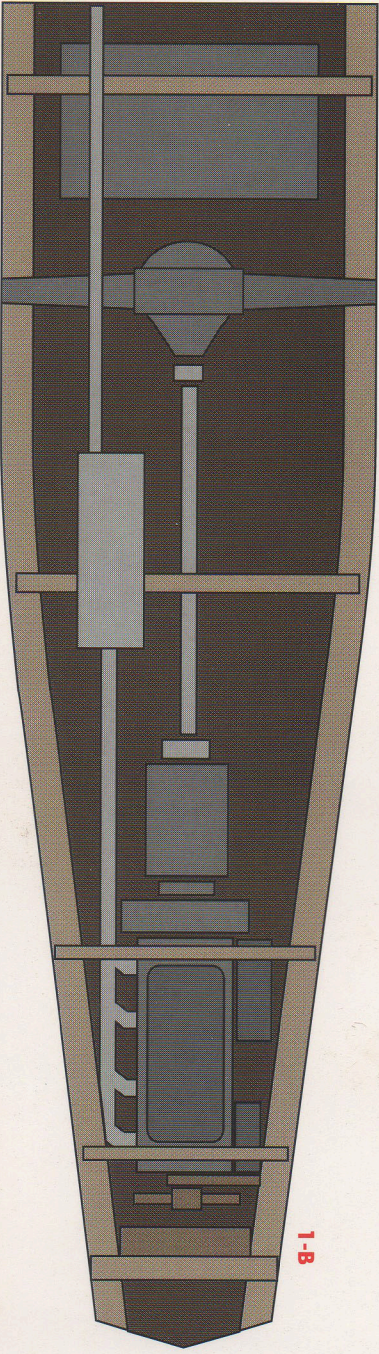
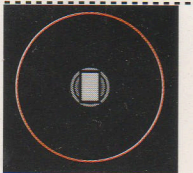

1-B

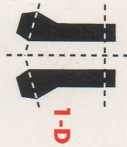

1-D

BMW - 315 - 1936 - 1

©1993 by ALCAN S.L.

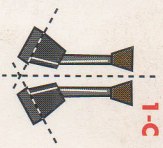

1-C

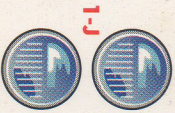

1-J

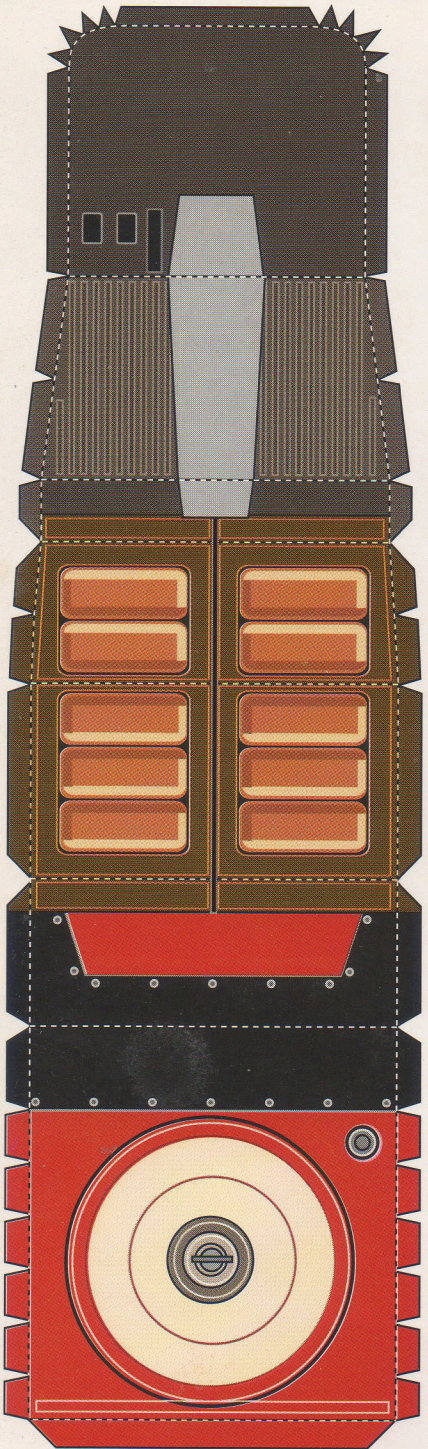

1-A





© 1993 by ALCAN, S.L.

BMW - 315 - 1936 - 2

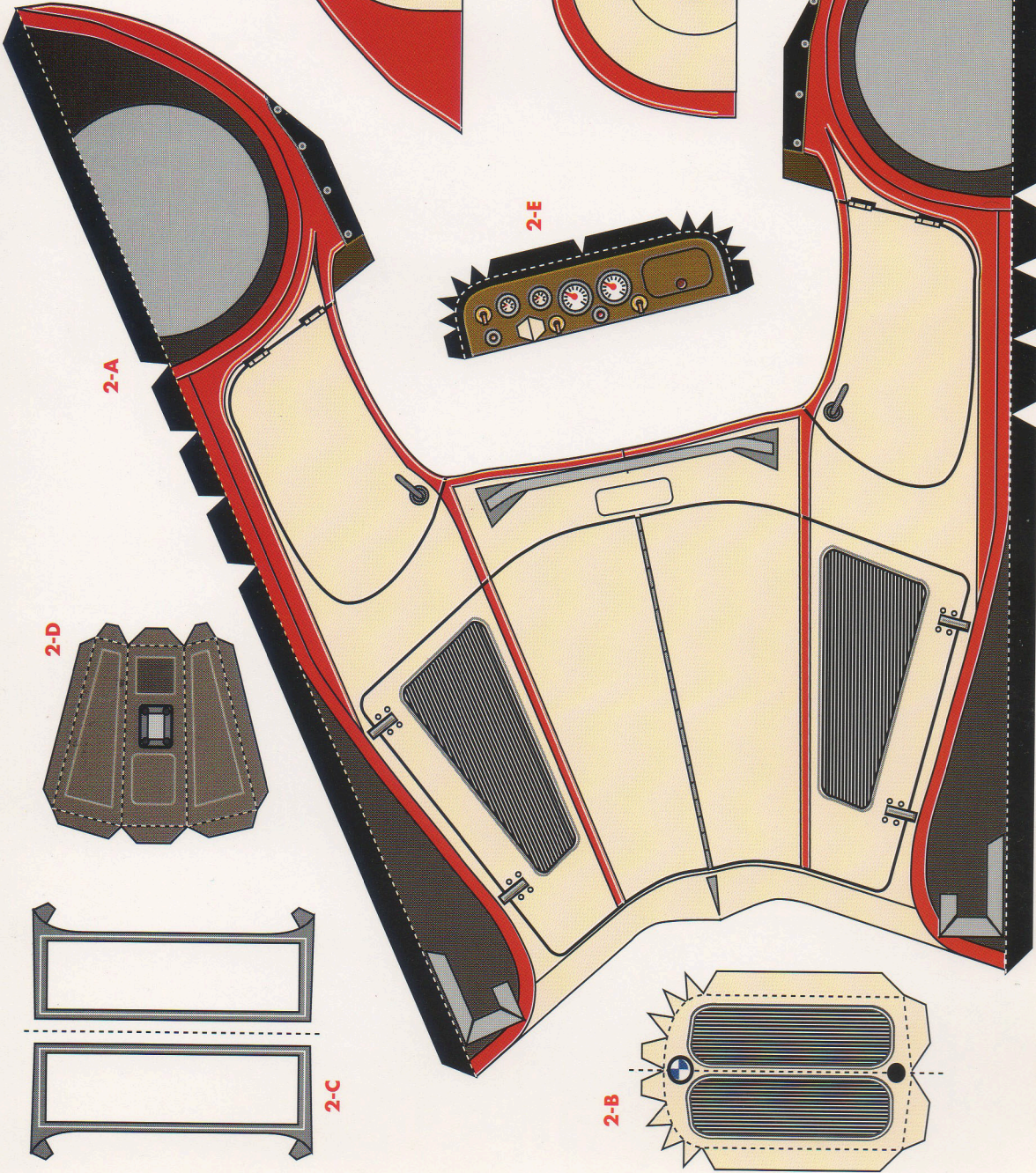

2-A

2-D

2-C

2-E

2-F

2-G

2-B



3-L

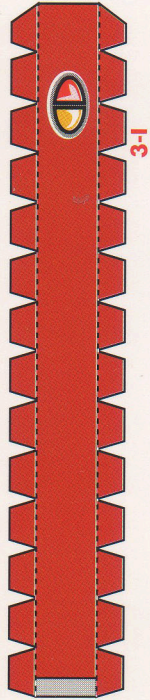

3-I

3-I

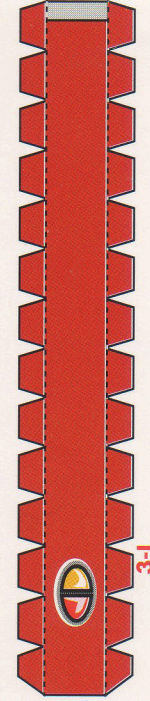

3-I



3-L



3-I

3-K



3-H

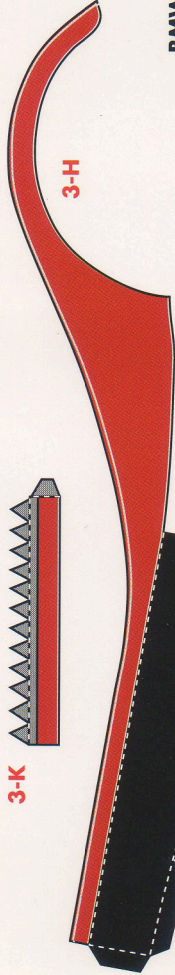

3-J



© 1993 by ALCAN, S.L.

BMW - 315 - 1936 - 3

3-L

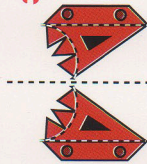

3-L

3-E



3-F

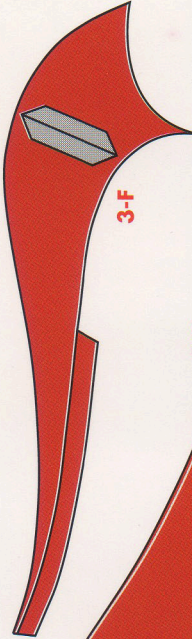

3-M



3-E

3-G



3-B

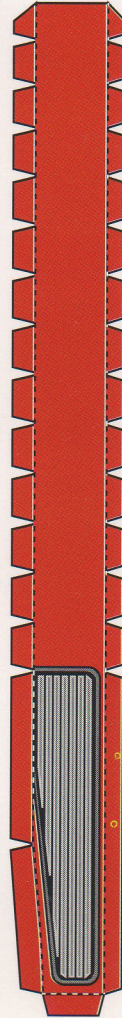

3-D

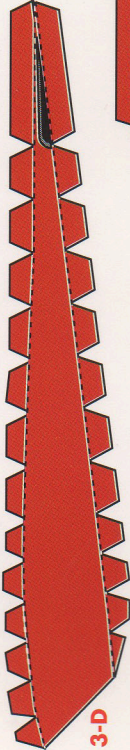

3-C

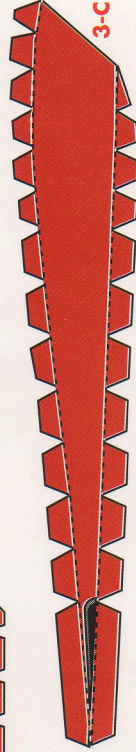

3-A

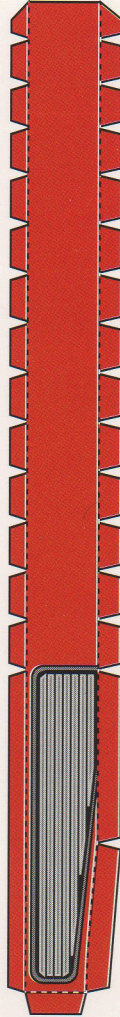

3-K





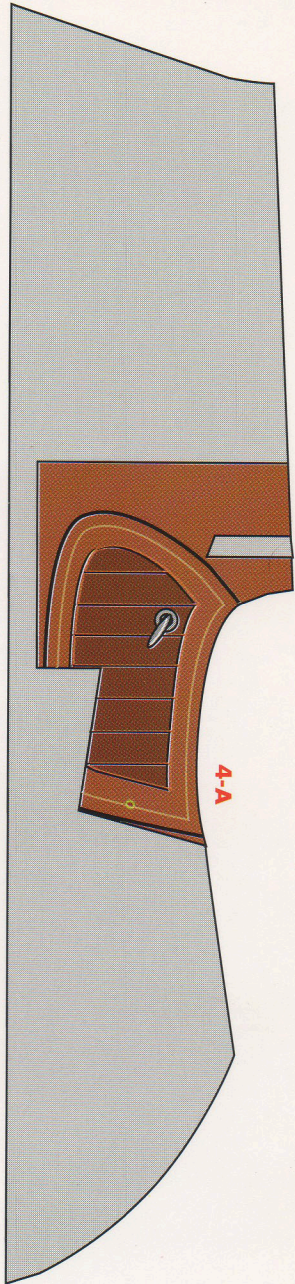

4-A

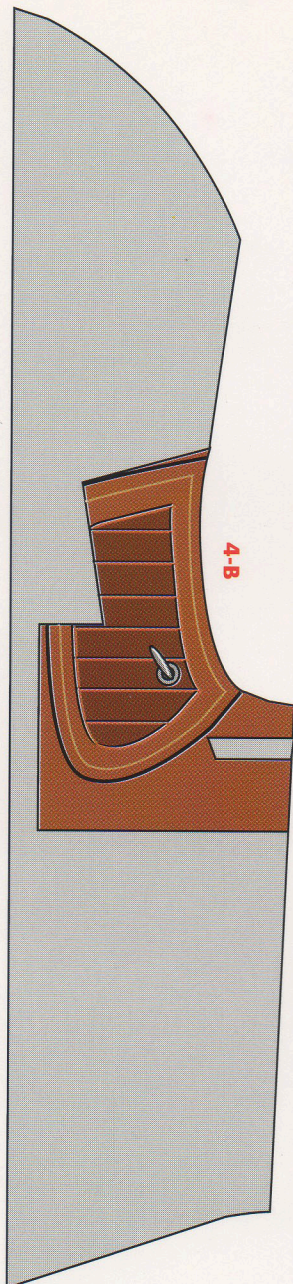

4-B

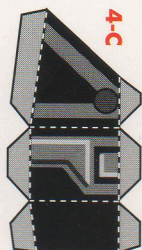

4-C

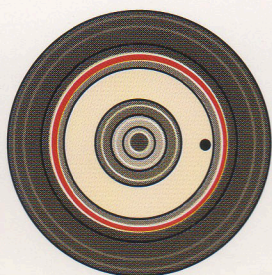

4-E

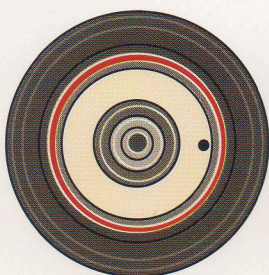

BMW - 315 - 1936 - 4

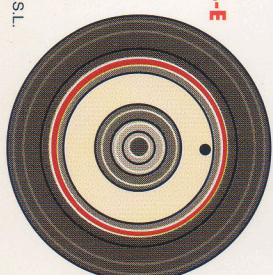

4-E

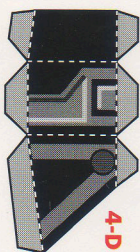

4-D

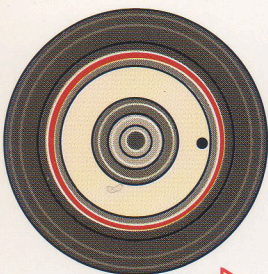

4-E



4-F

4-F

4-F



©1993 by ALCAN, S.L.