

HAMPDEN Mk I



Fly Model

Nr 15

MODEL
WARSZAWA
1-33

rys. 5

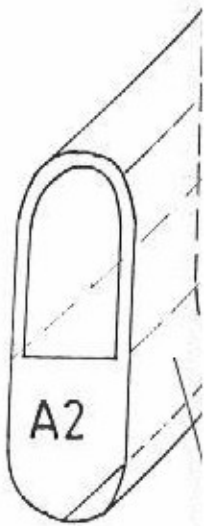
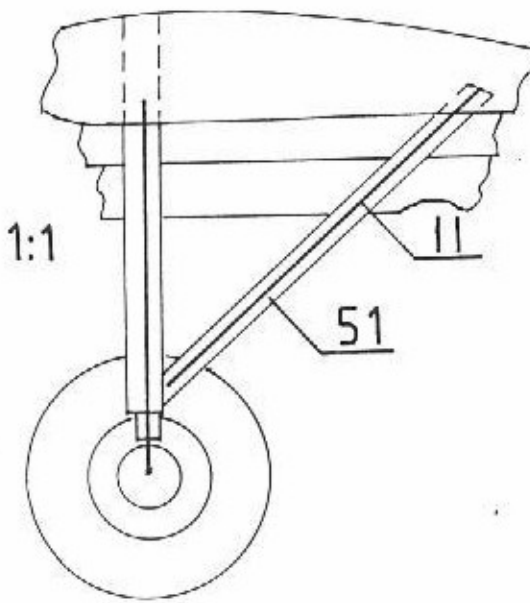
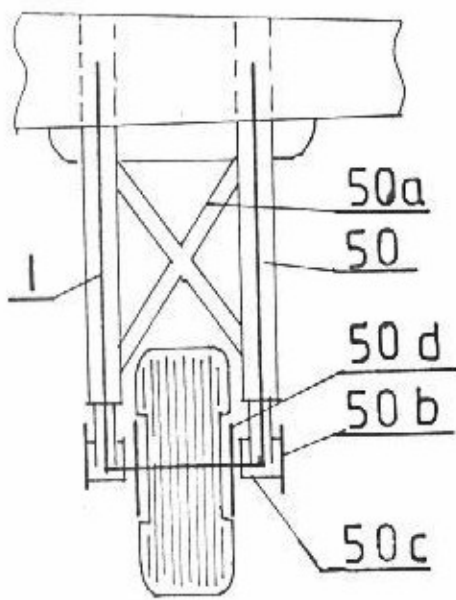
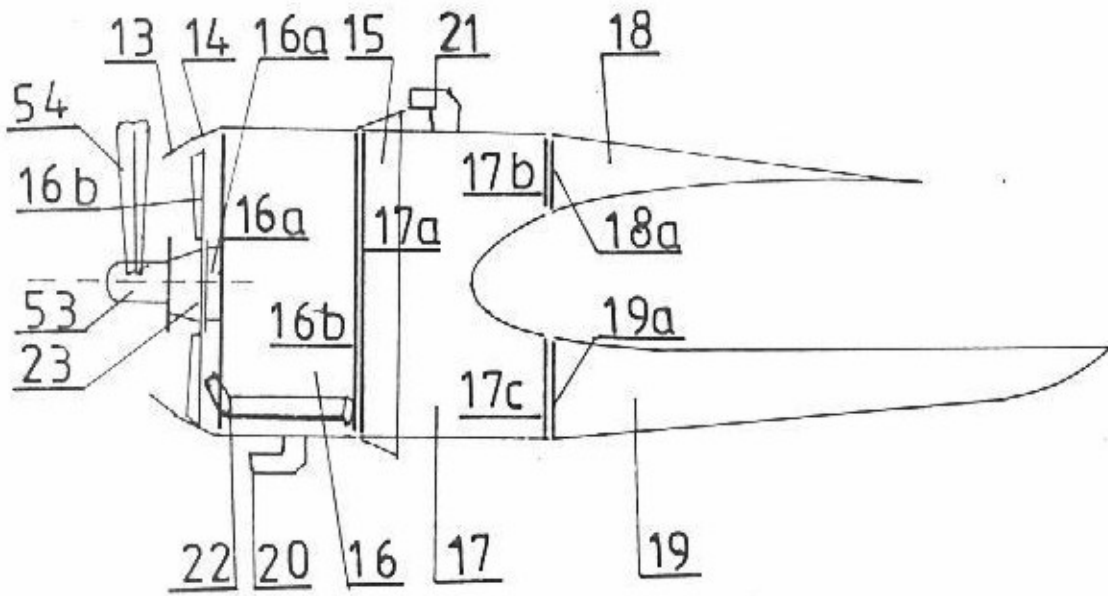

rys. 6

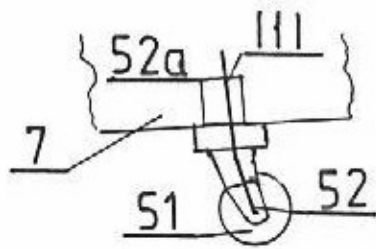
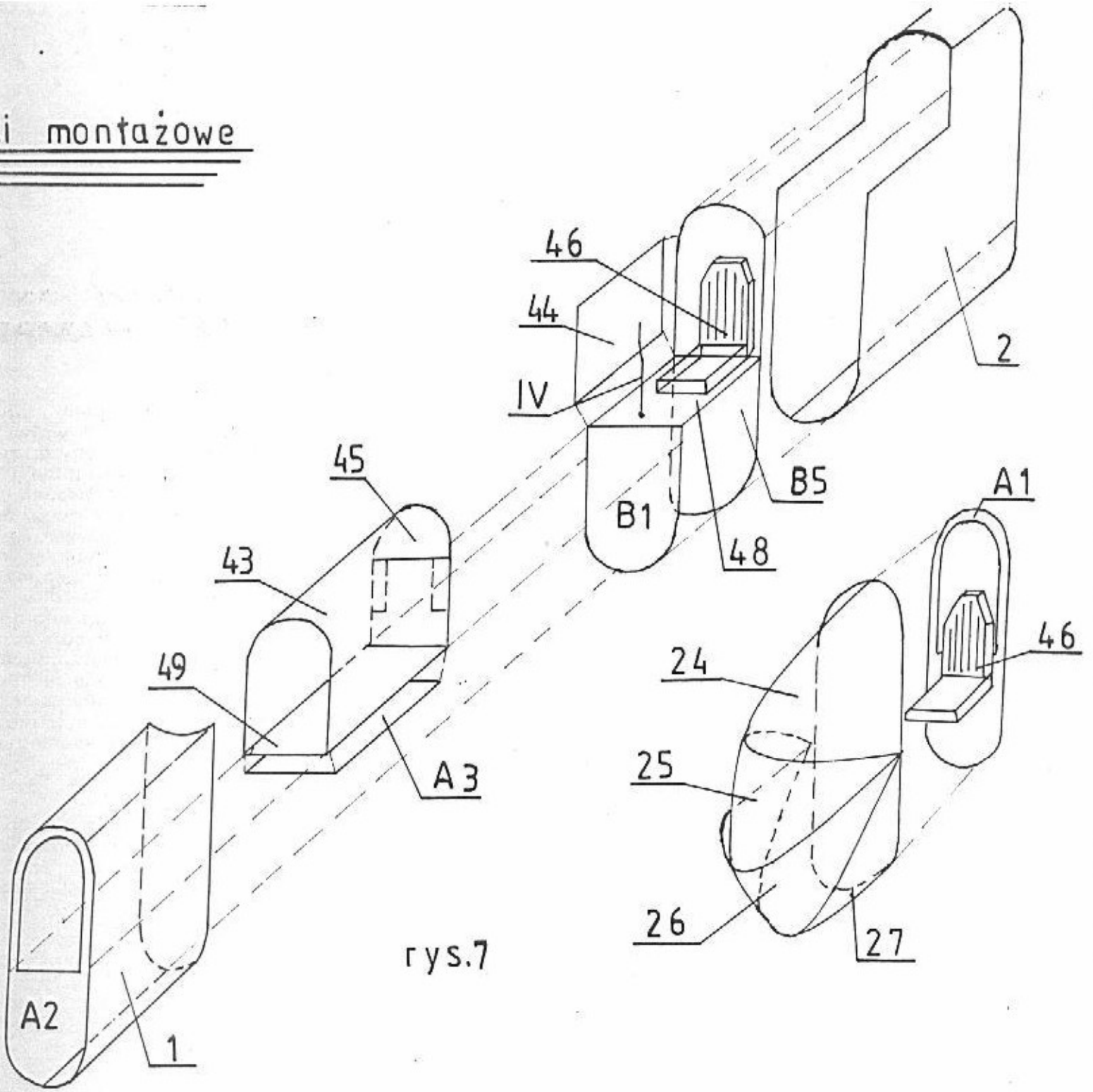

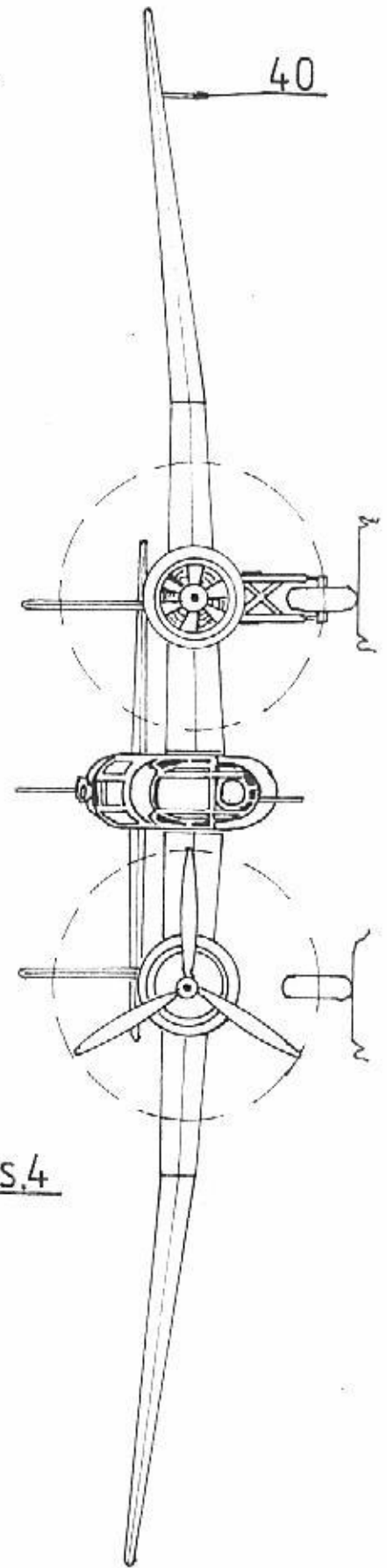
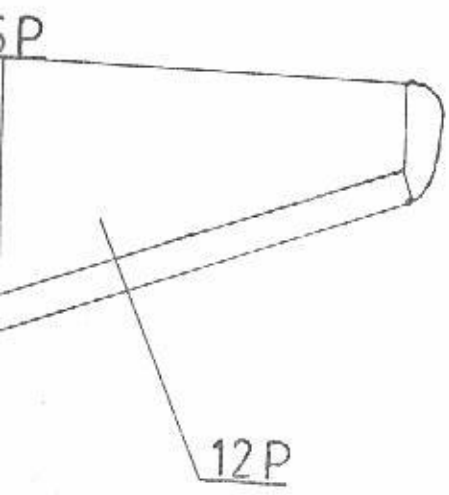
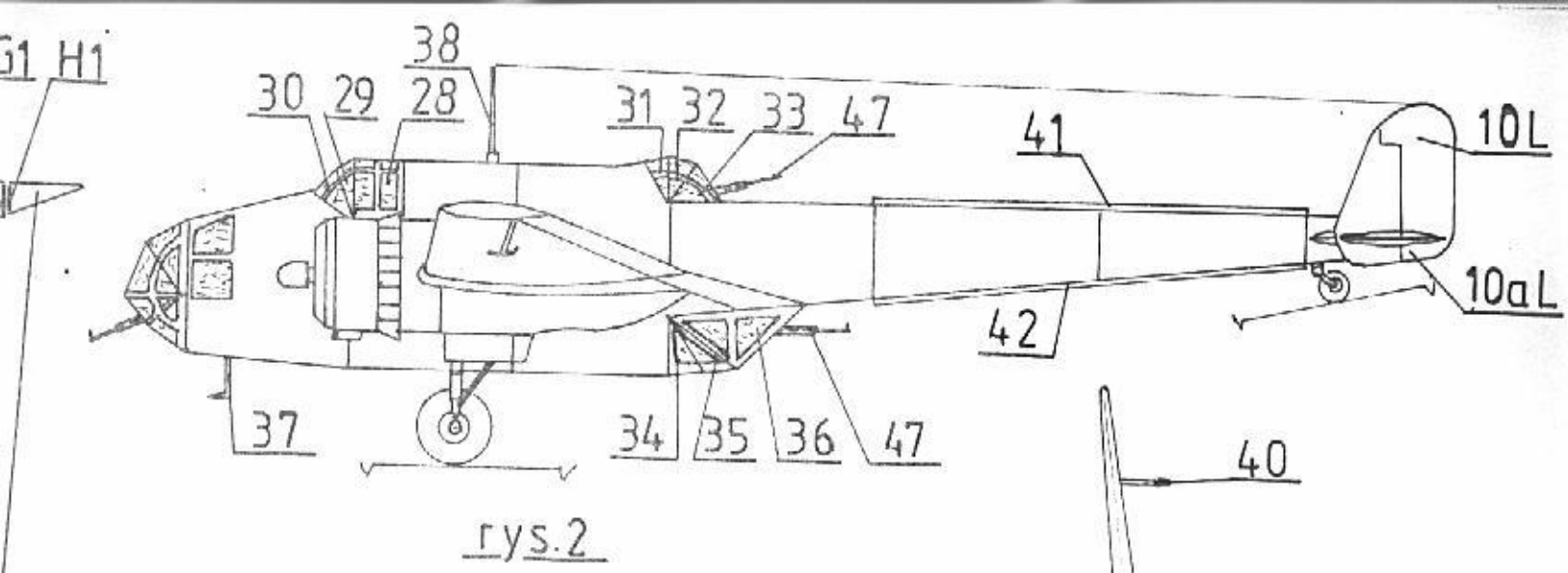

Rysunki główne

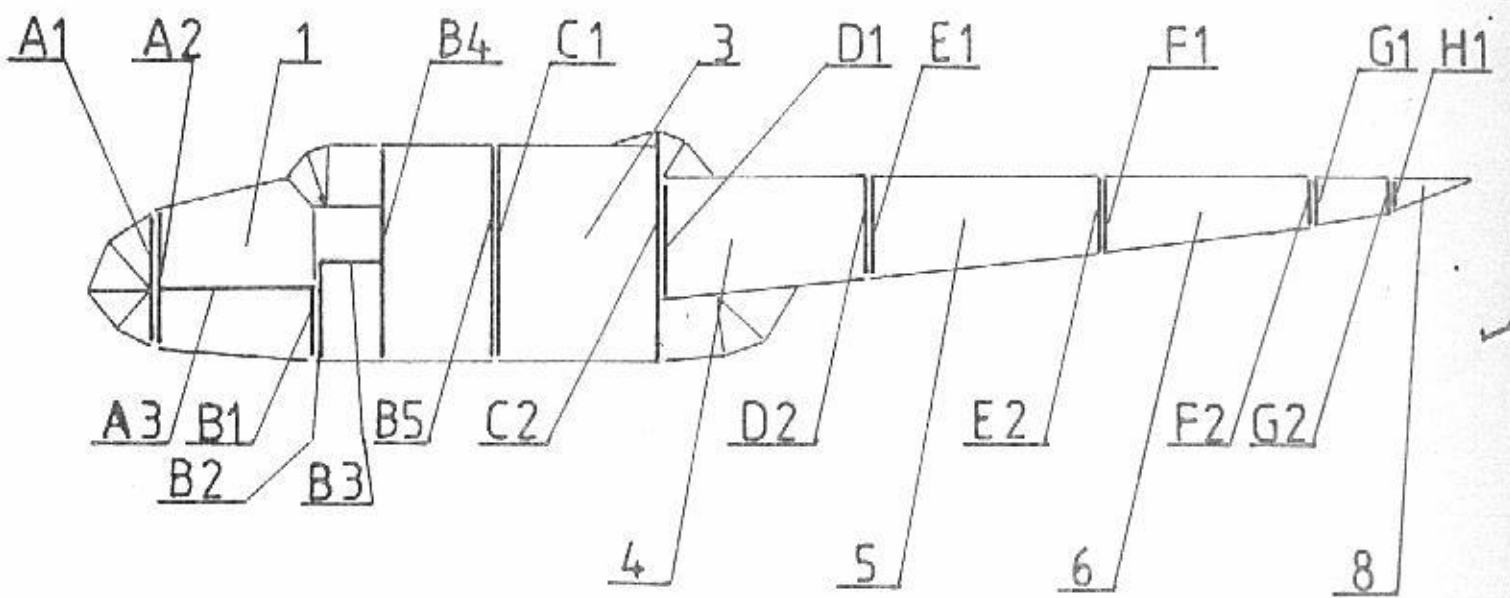

rys.1

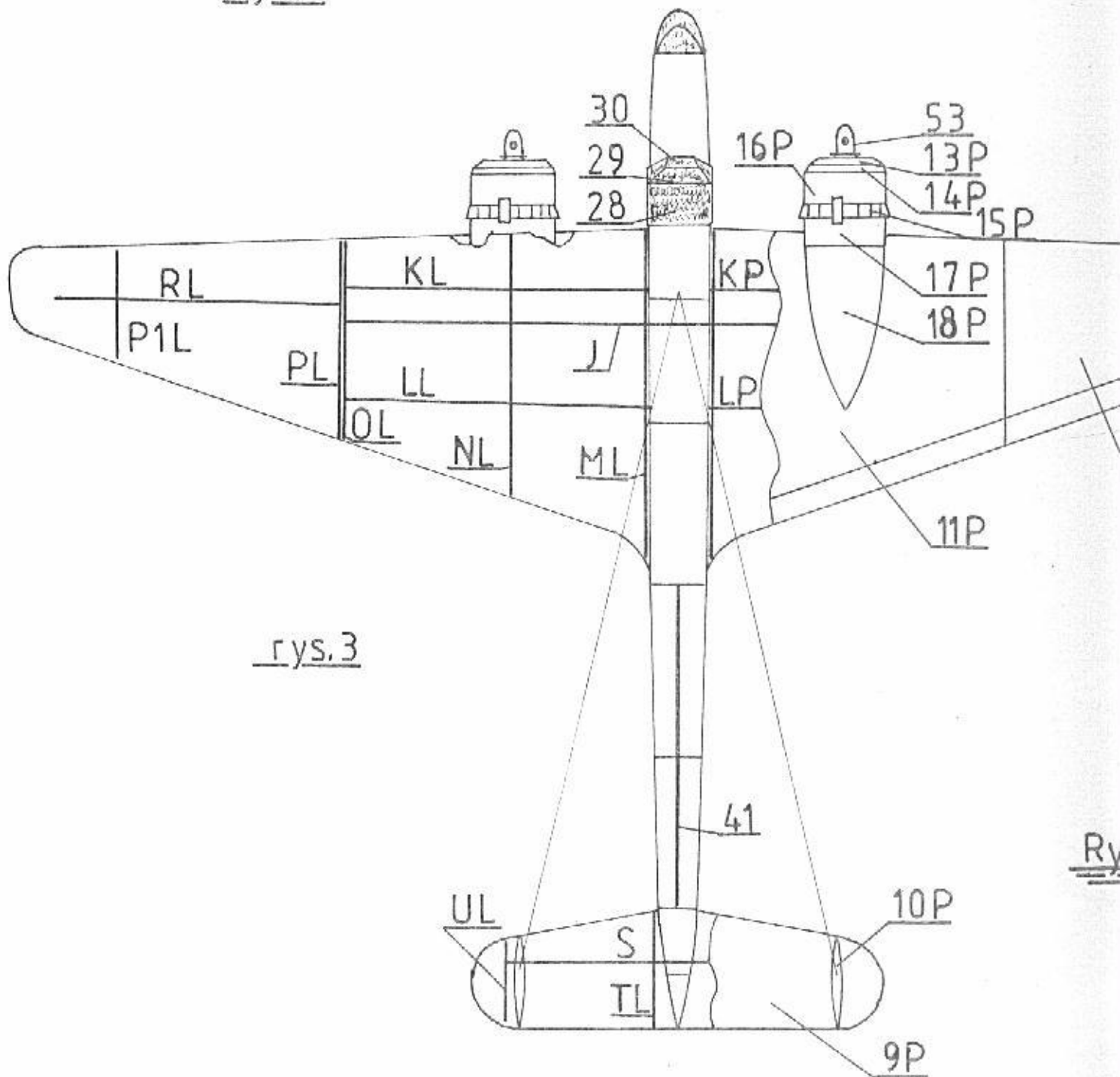

rys.3

Ry

51

51

50

51

51

B 2

47b

A 1

46

52a

W

W

19aL

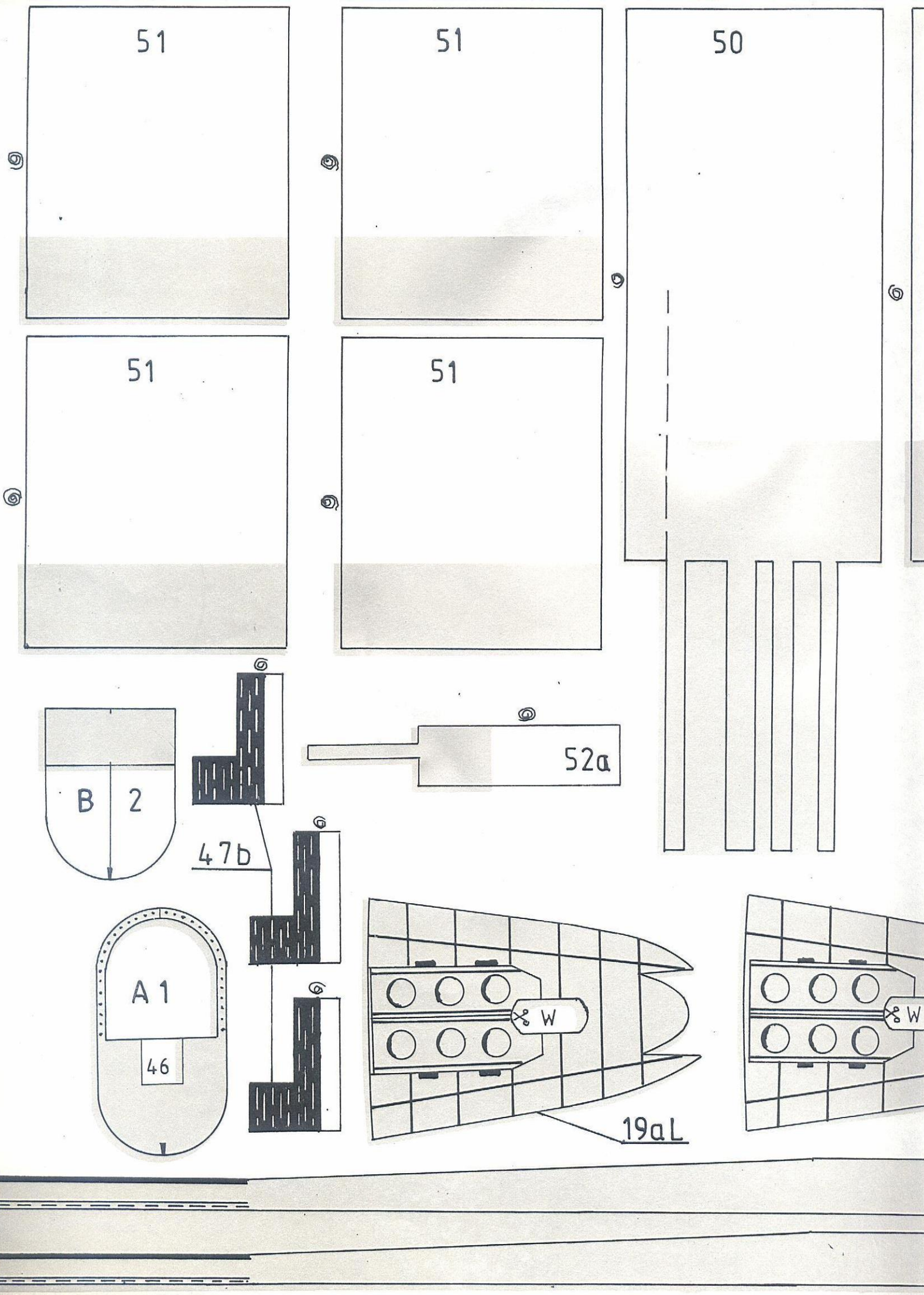

50

50

50

9

6

6

6

52a

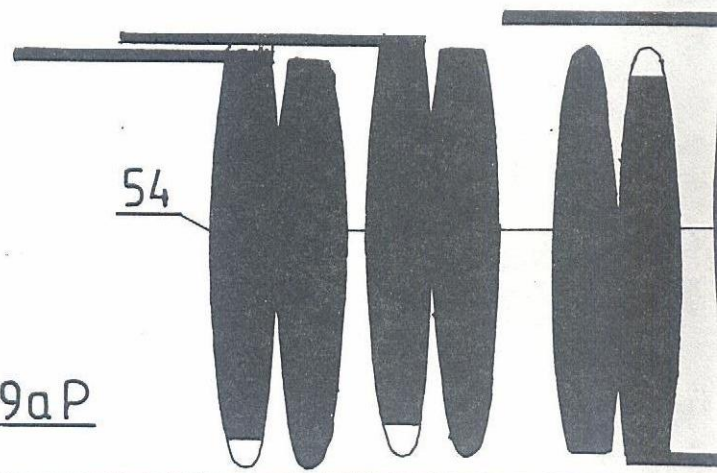
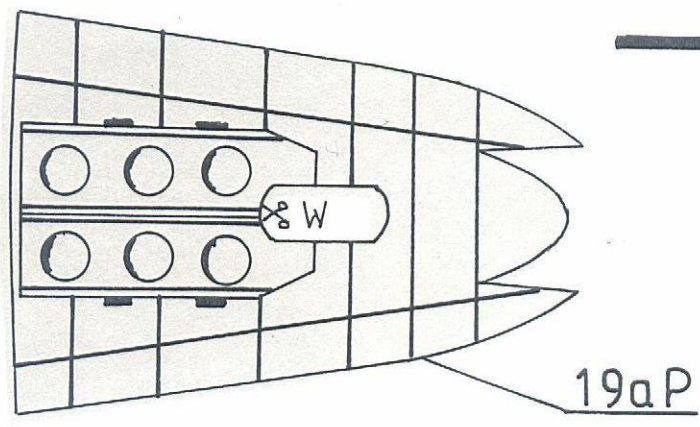
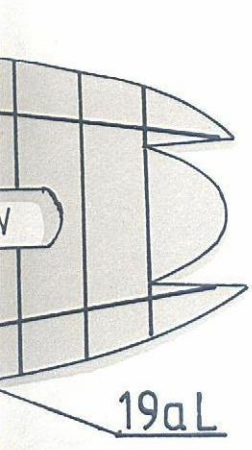

50

50

50

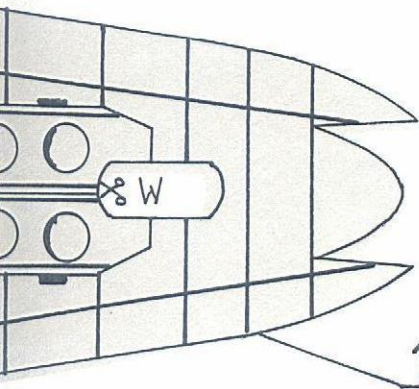

19aP

54

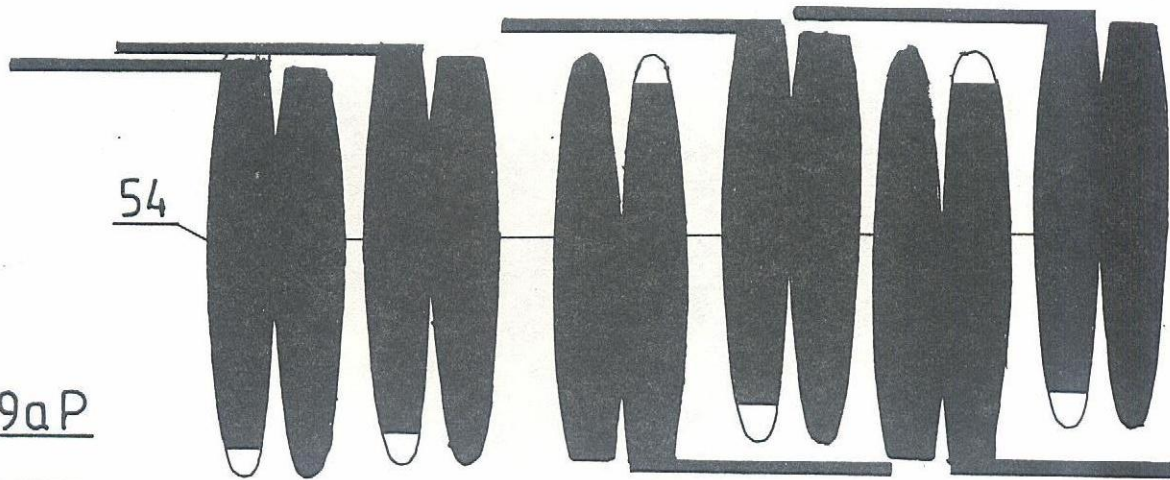

53

53

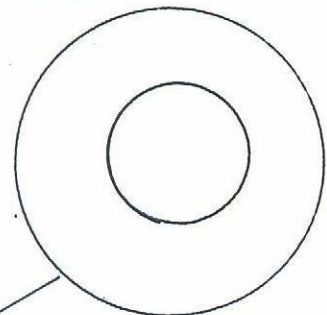
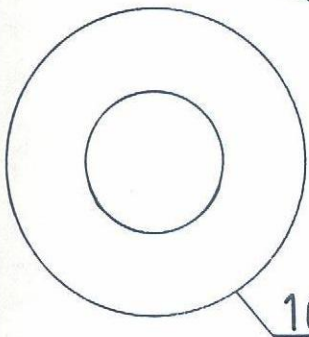
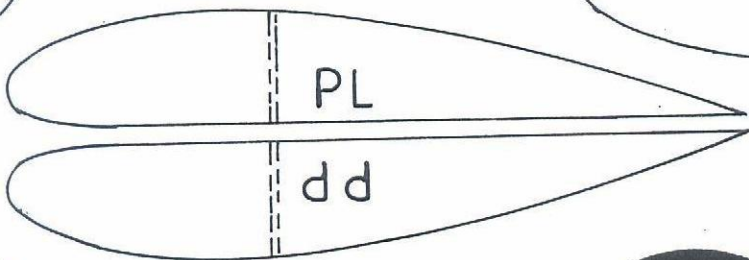
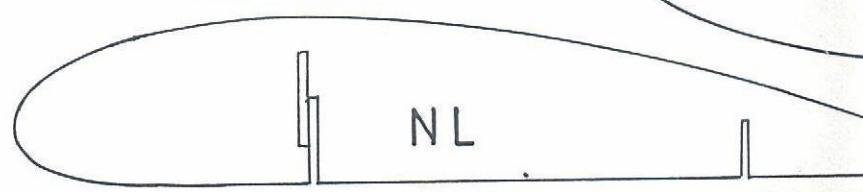
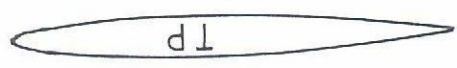
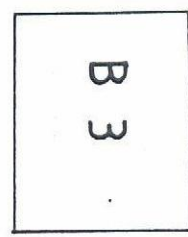
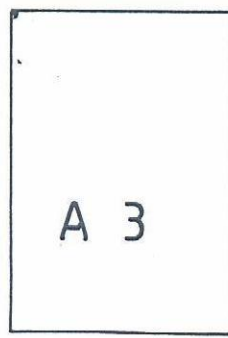
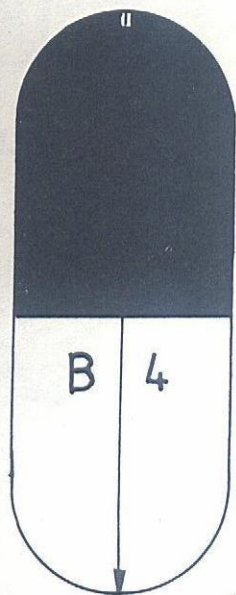
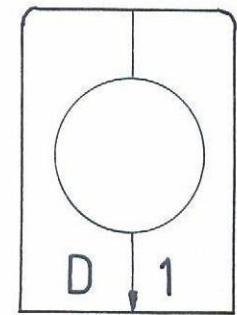
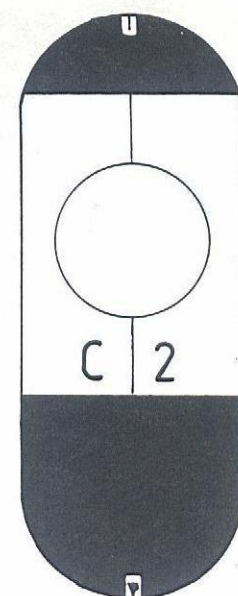
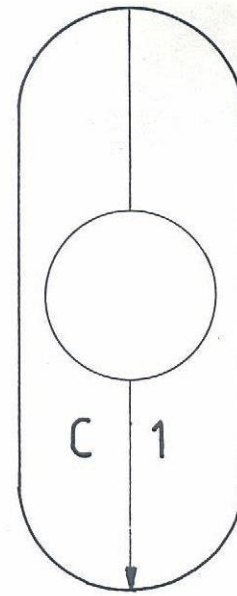
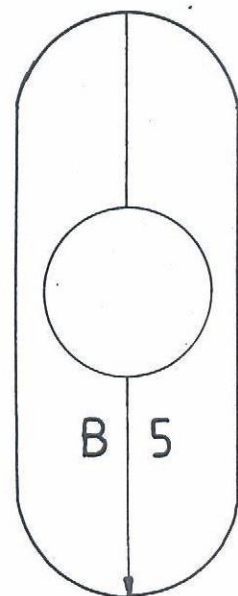
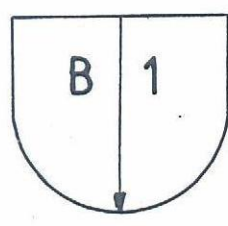
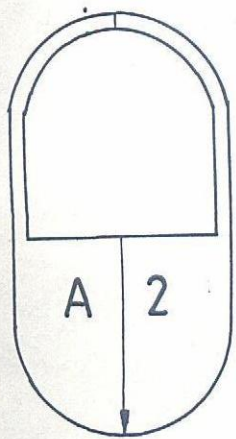

16b



16a

17b

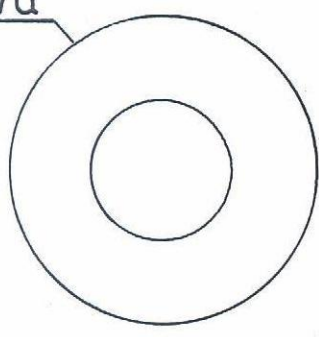
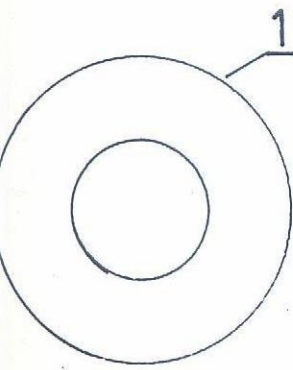

17a

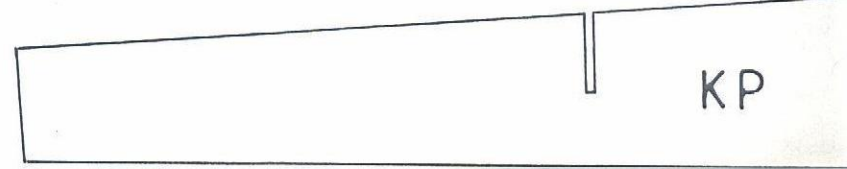
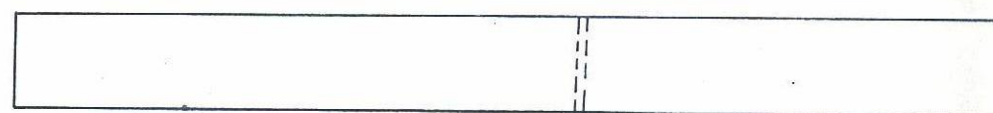
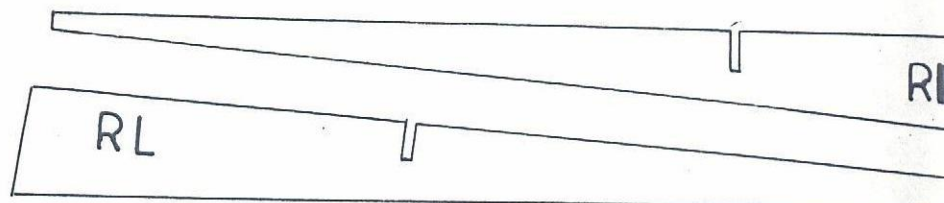

KP

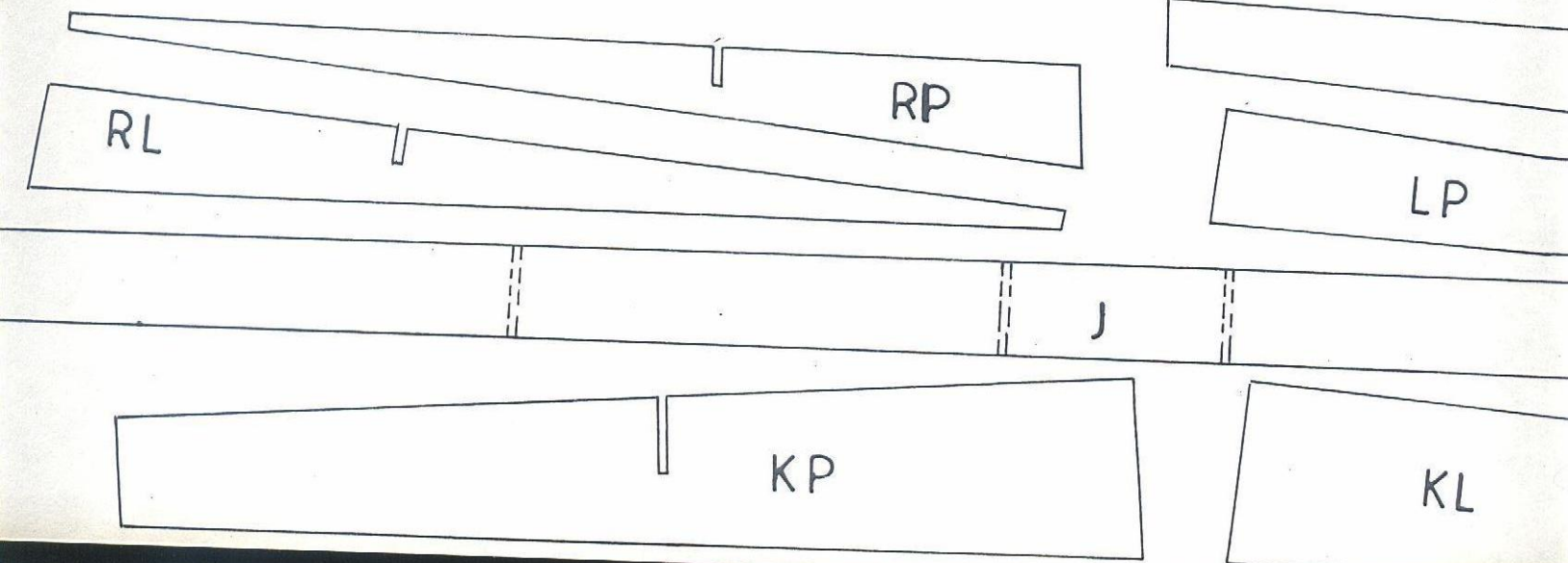
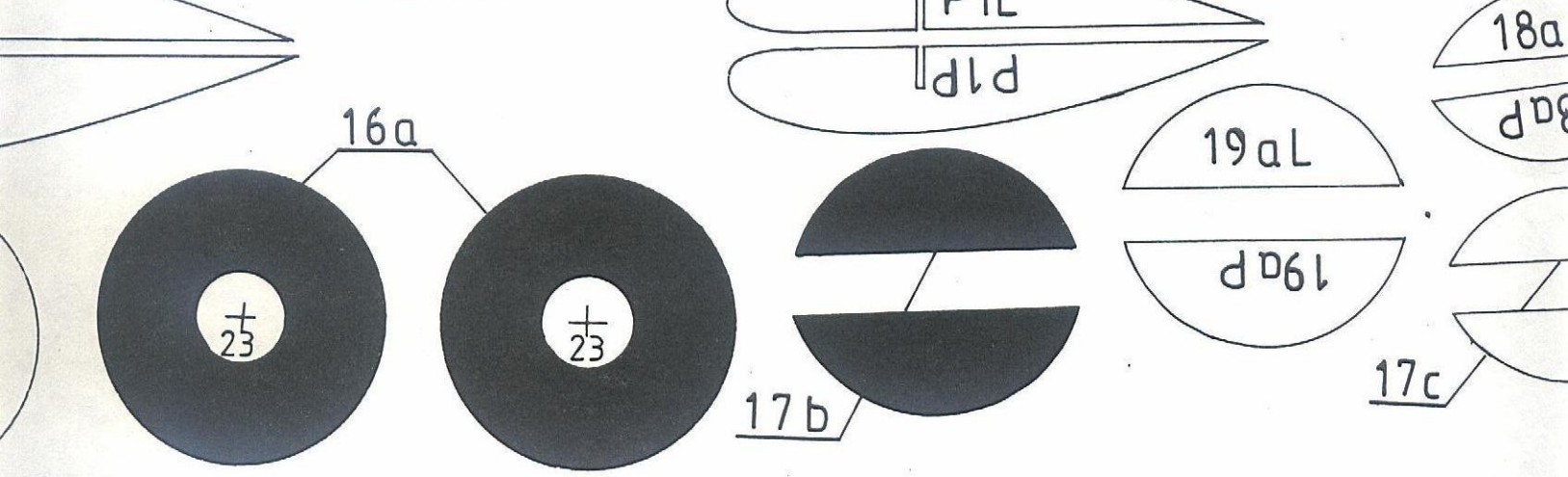
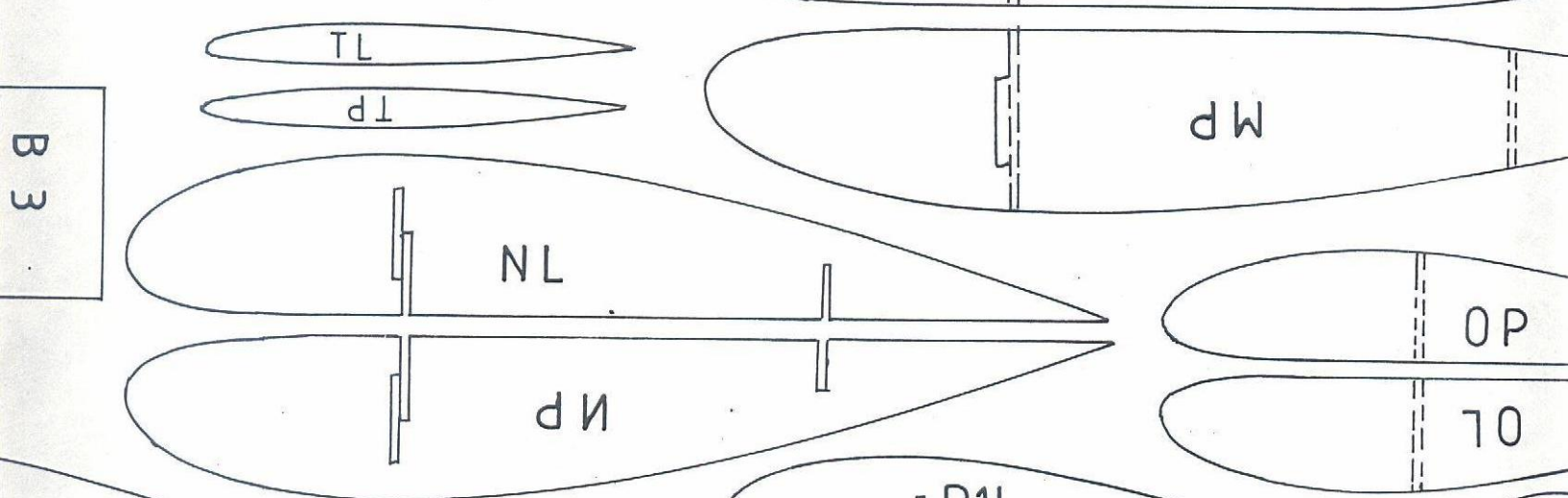
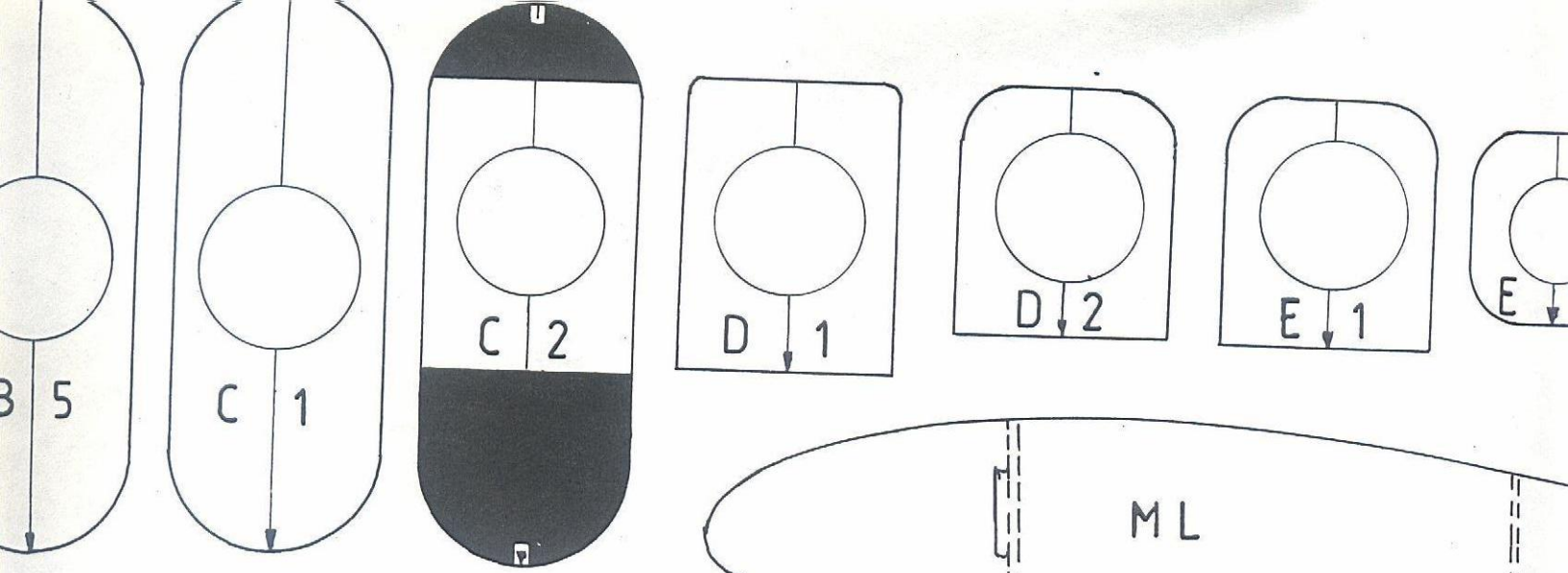

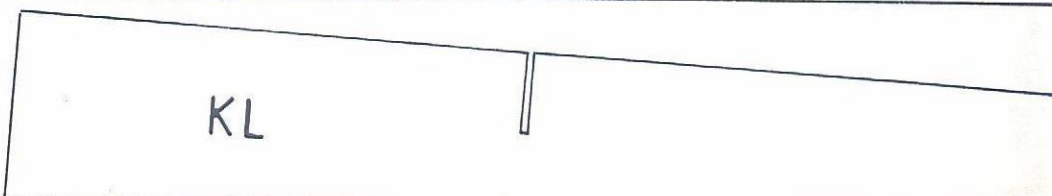
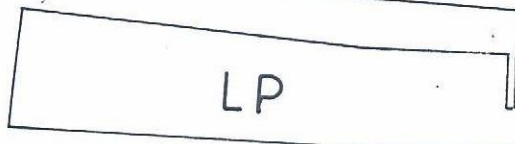
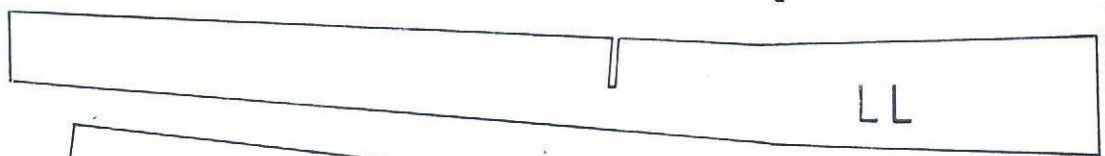
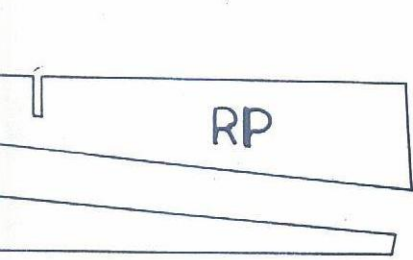
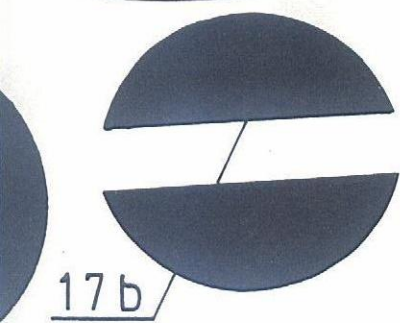
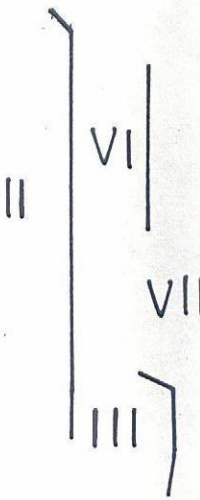
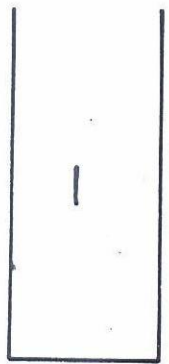
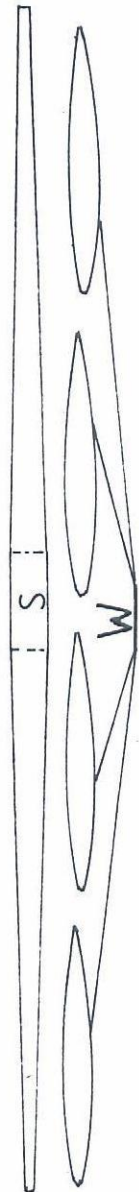
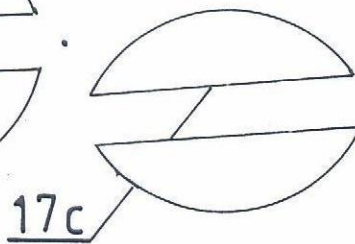
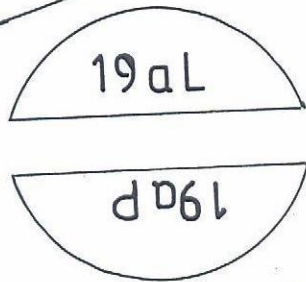
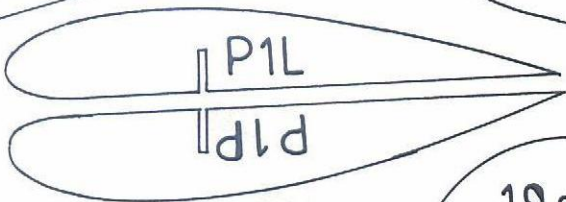
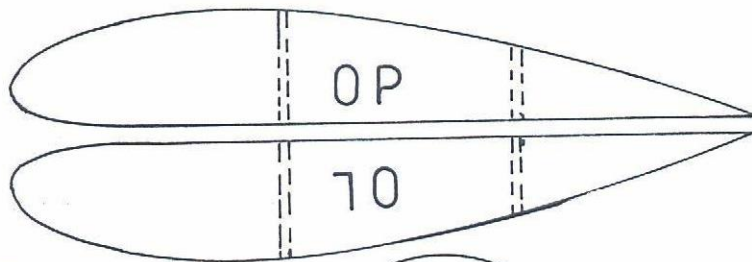
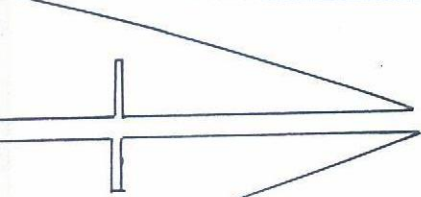
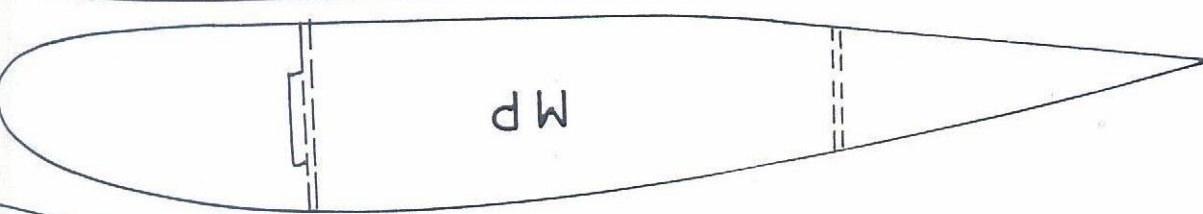
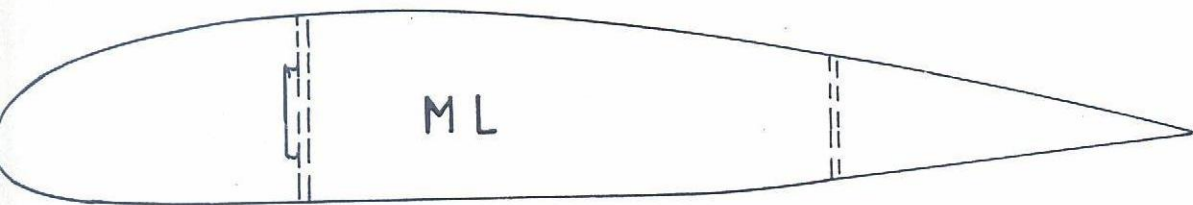
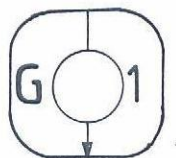
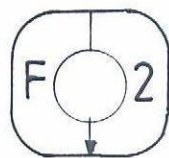
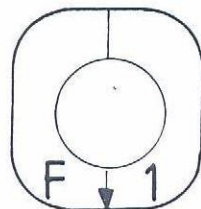
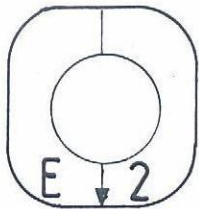
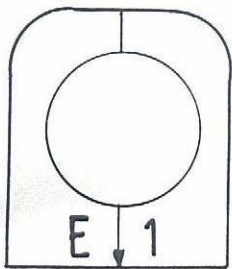
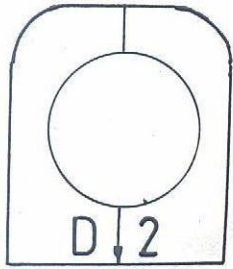
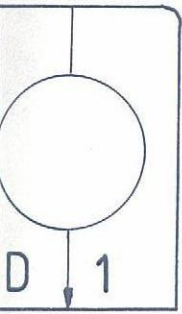

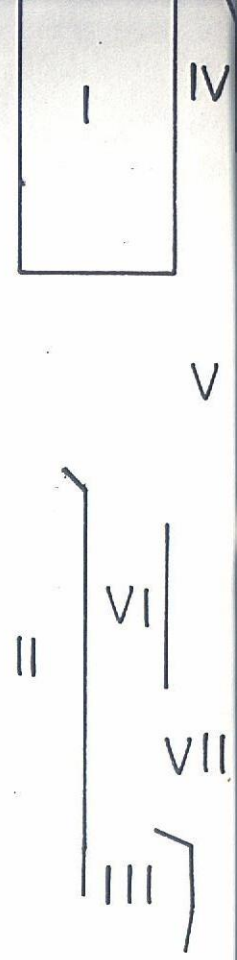
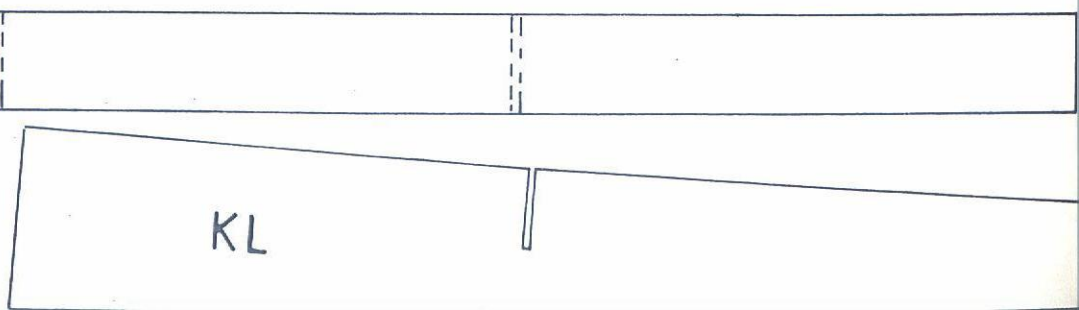
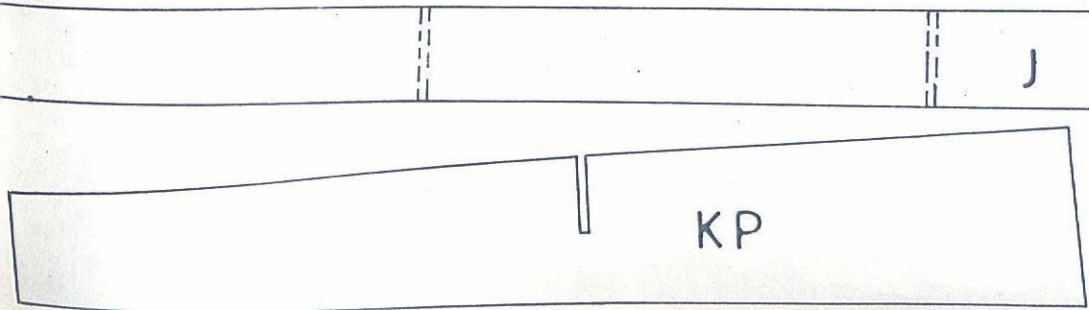
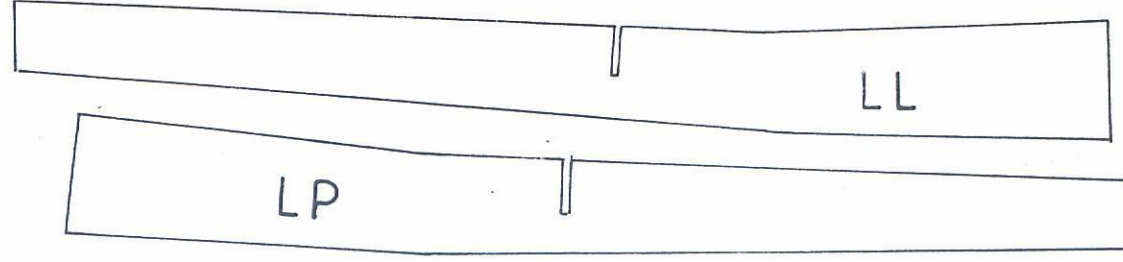
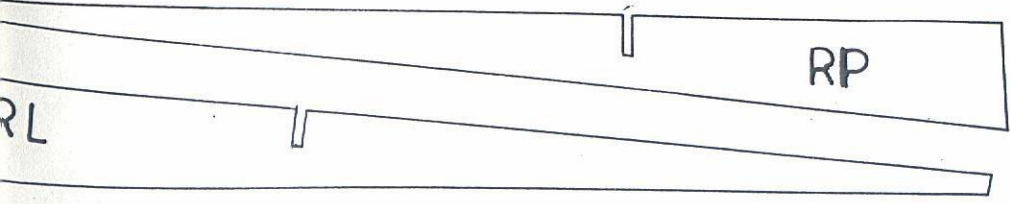
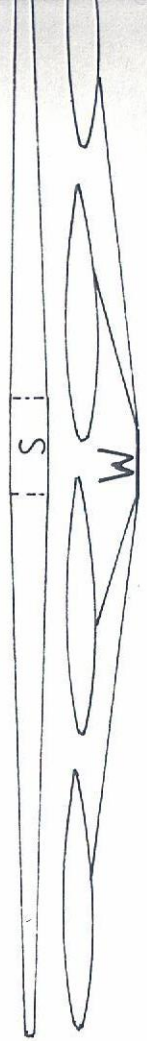
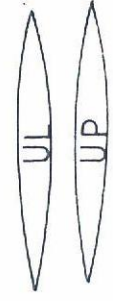
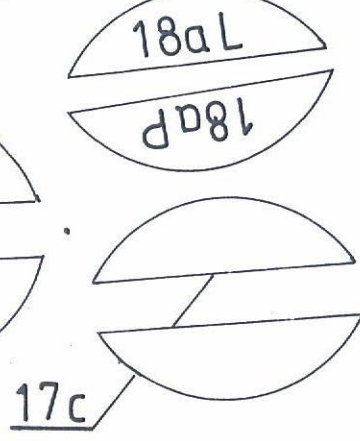
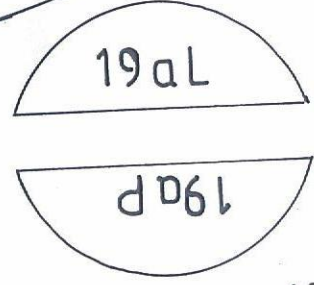
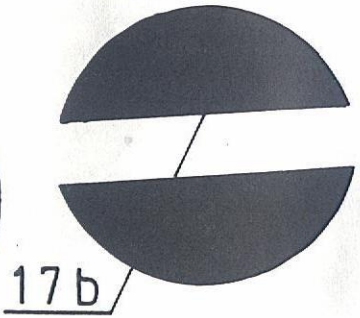
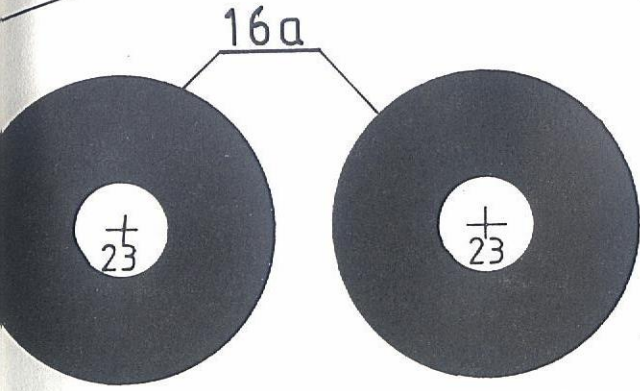
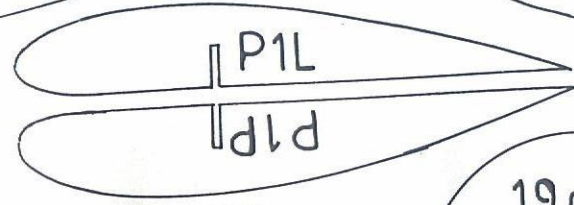
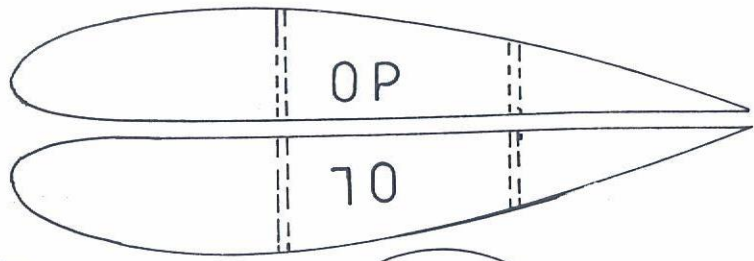
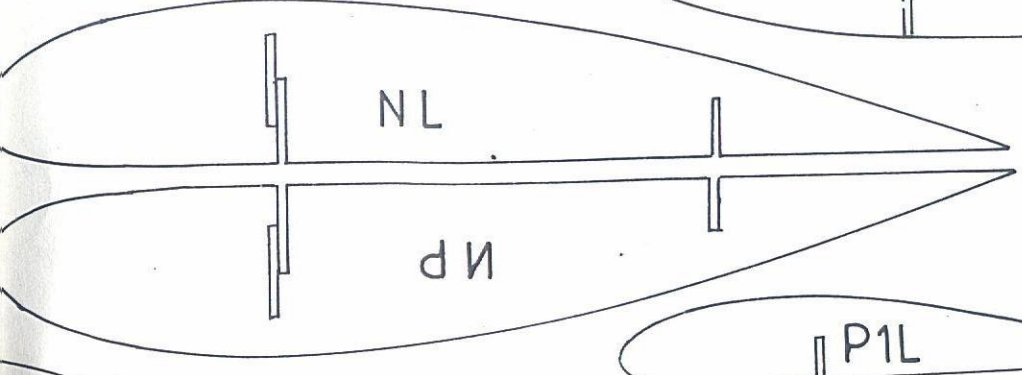
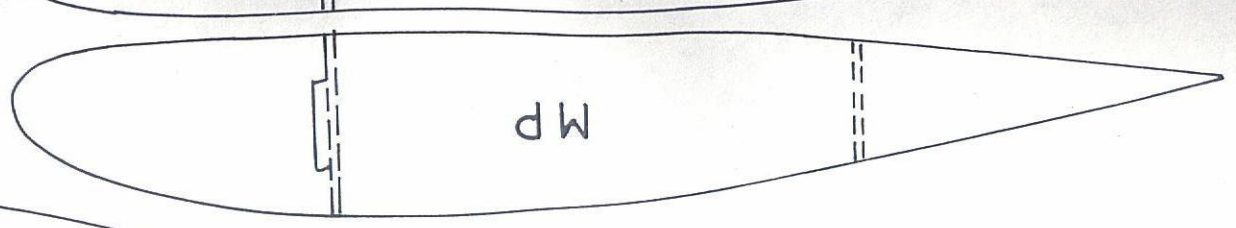
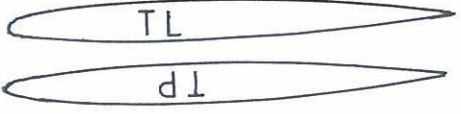

16a

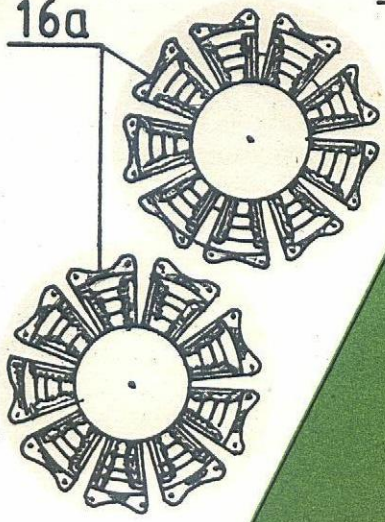

11L

16b

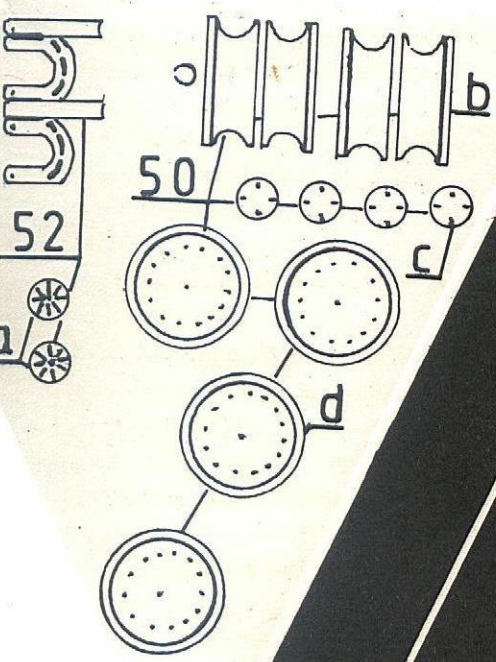

11P

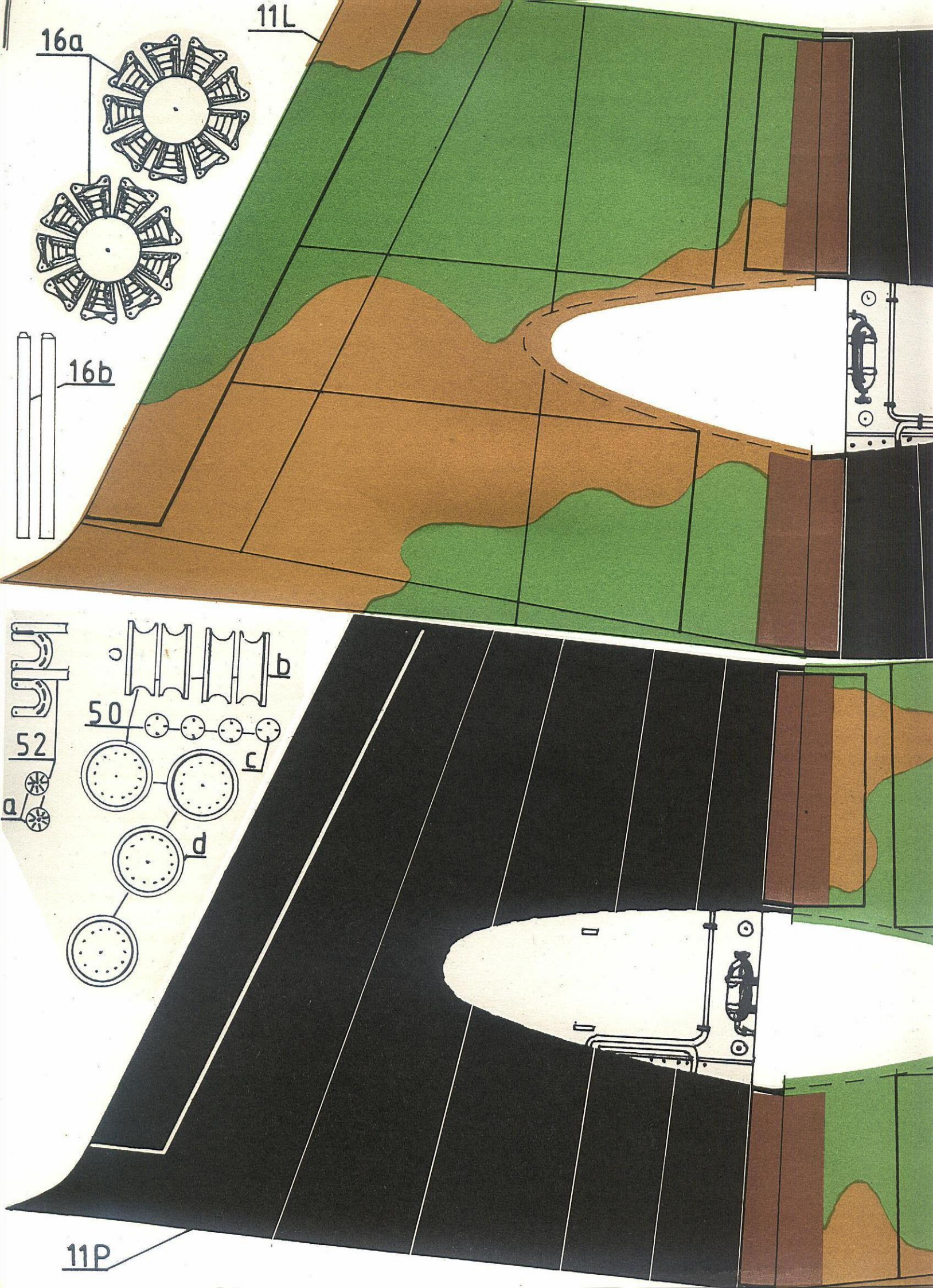

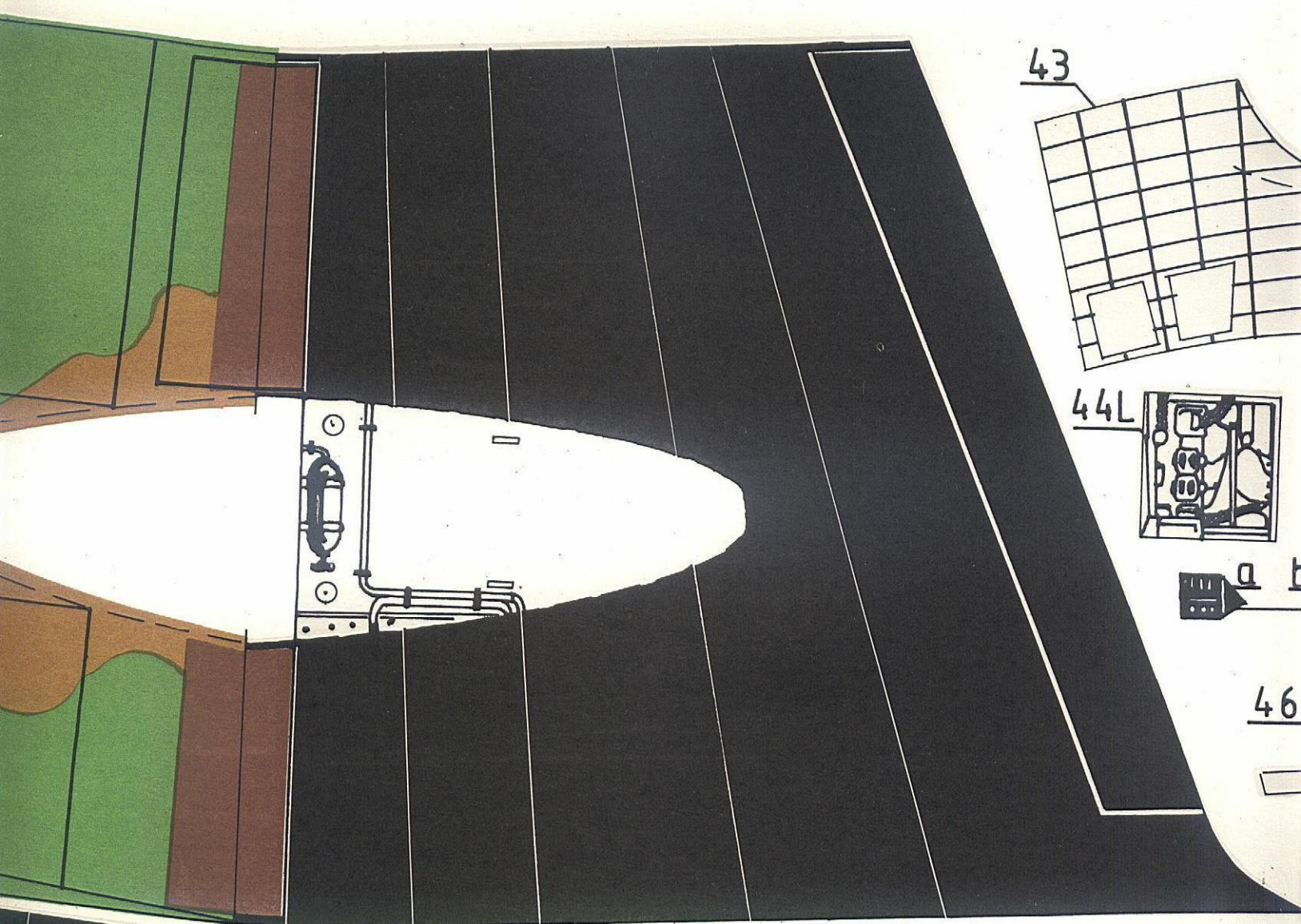

43

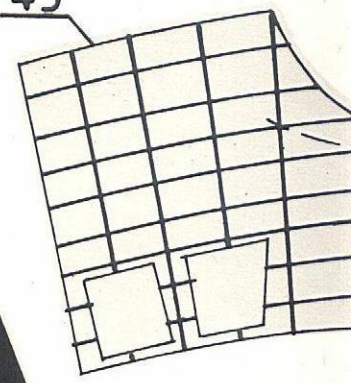

44L

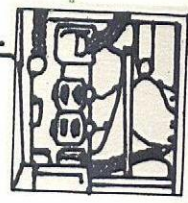

46

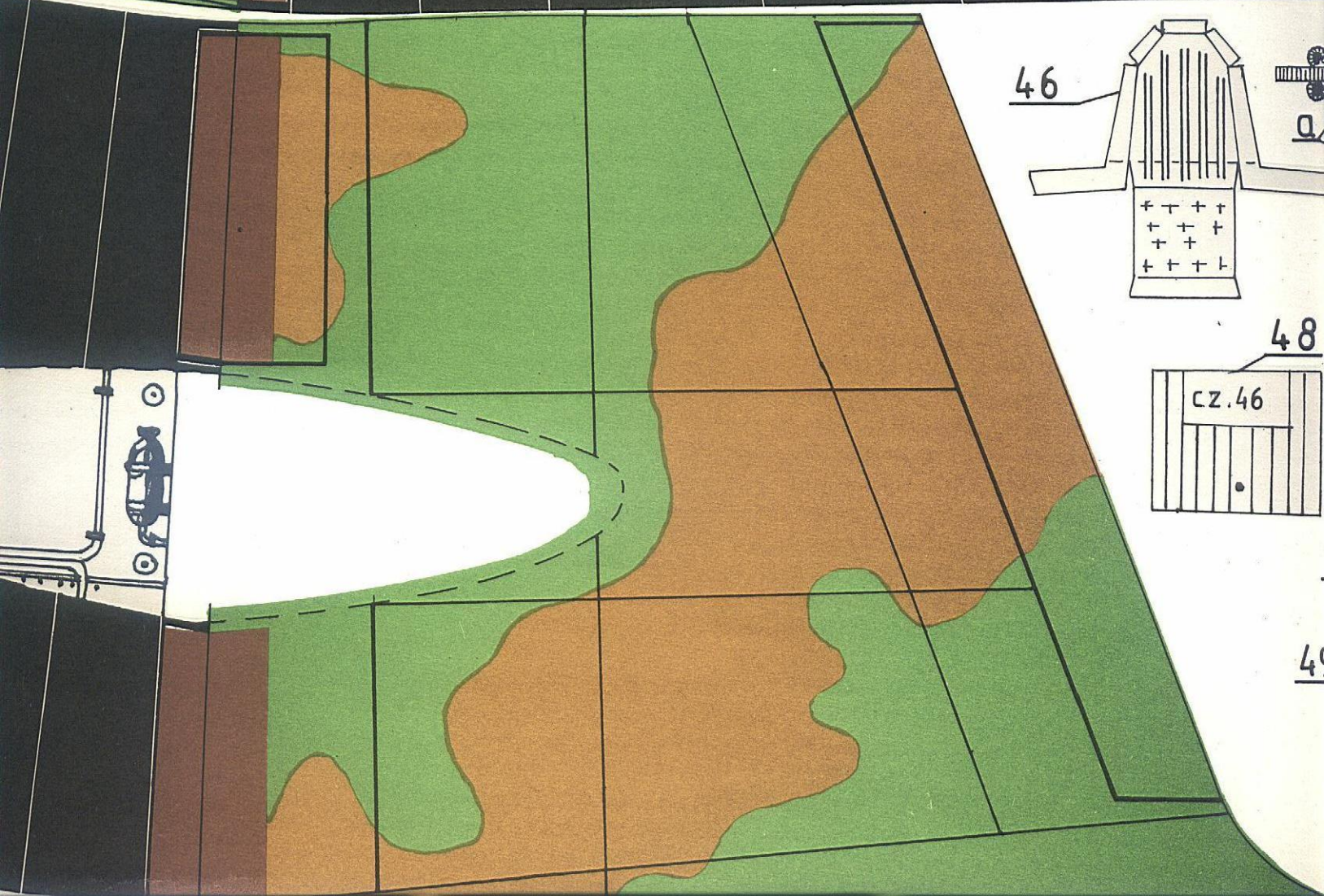

46

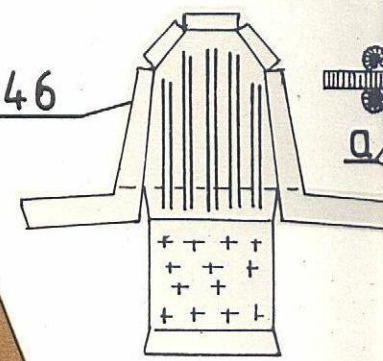

48

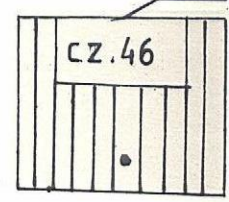

49

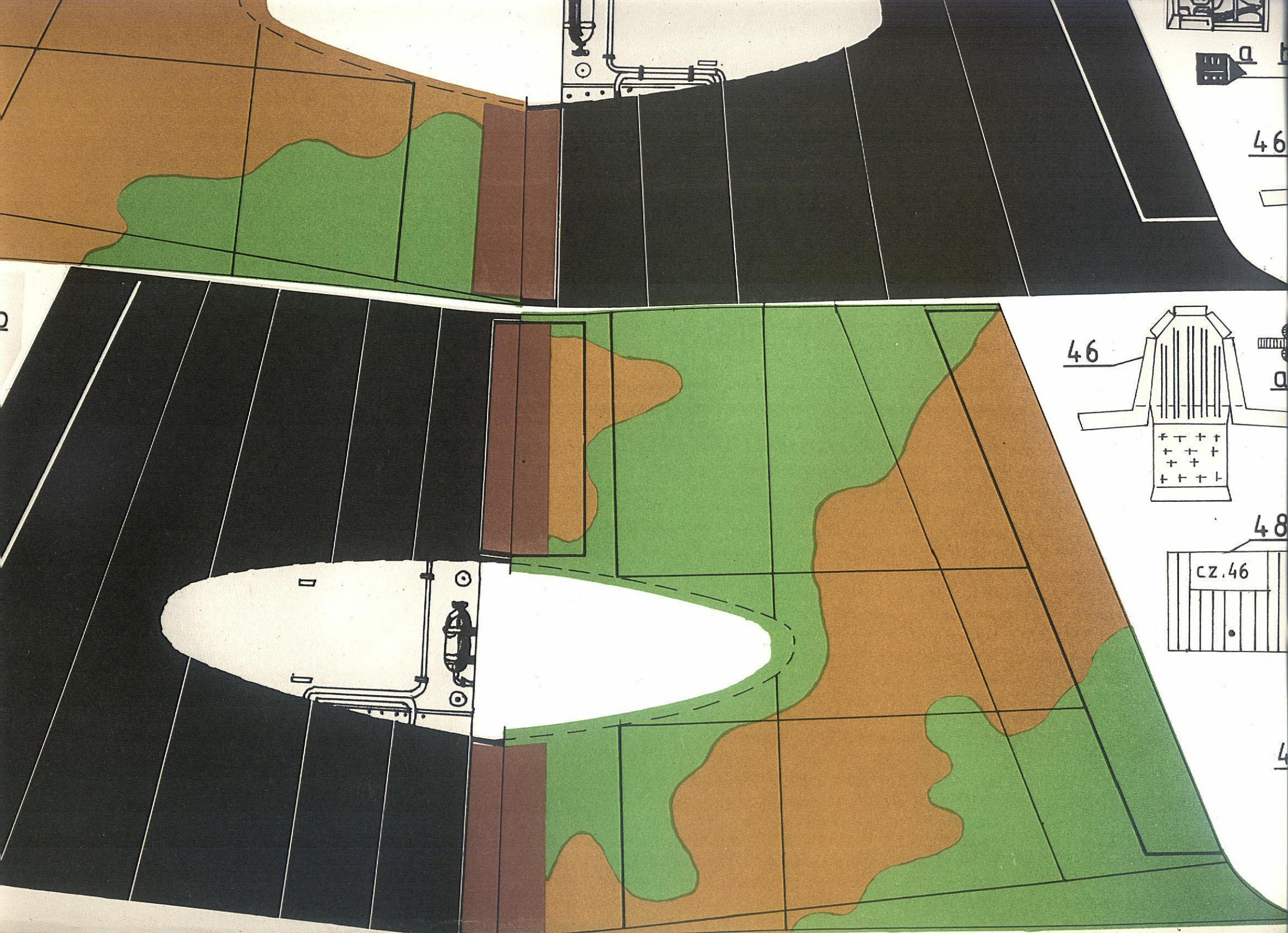

46

46

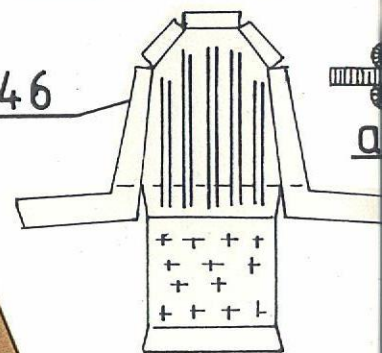

48

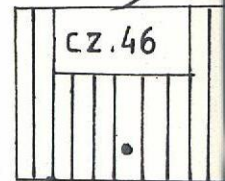

4

16a

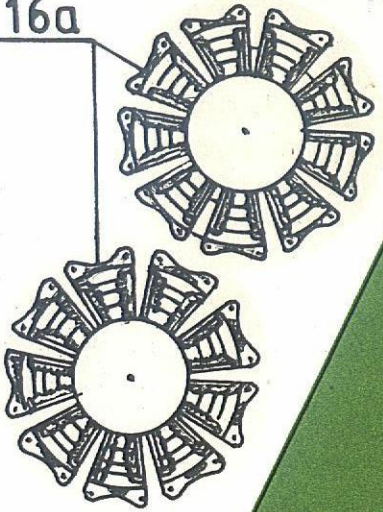

11L

16b

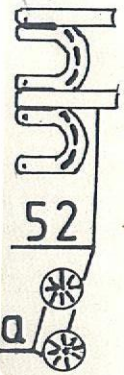

50

52

b

c

d



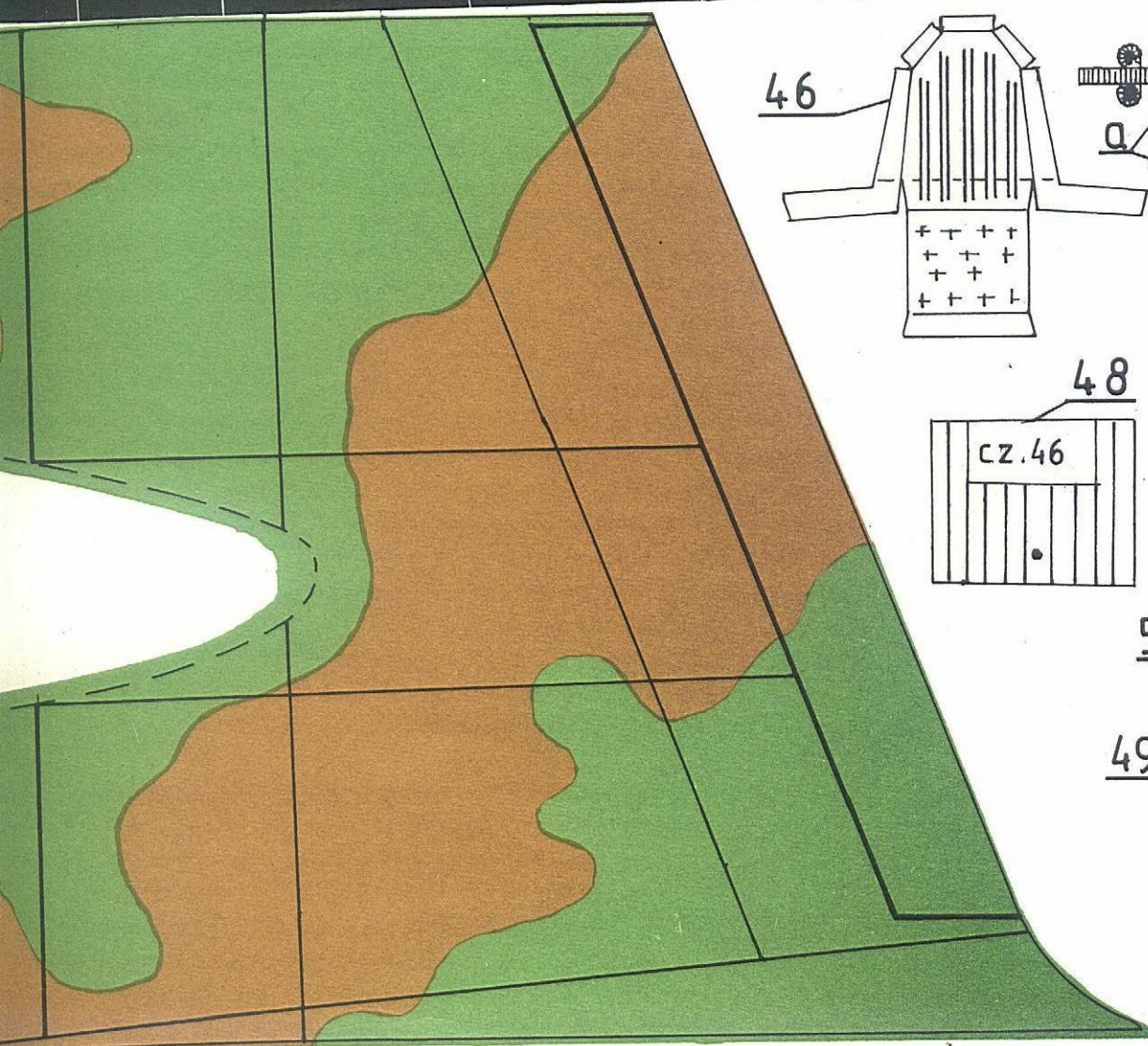
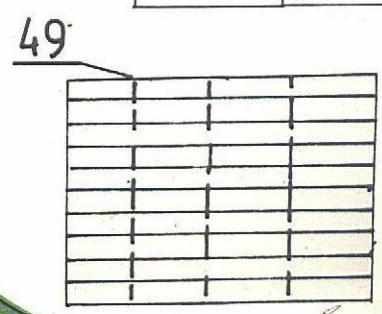
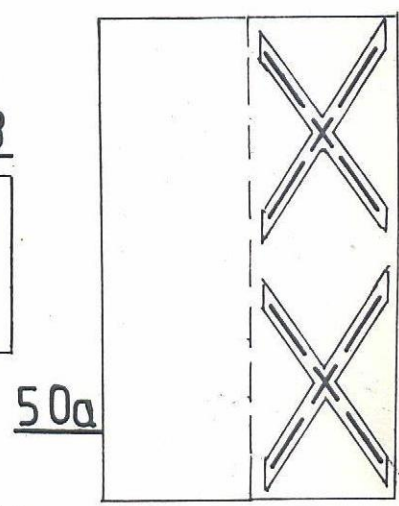
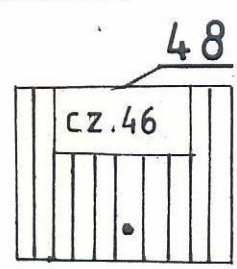
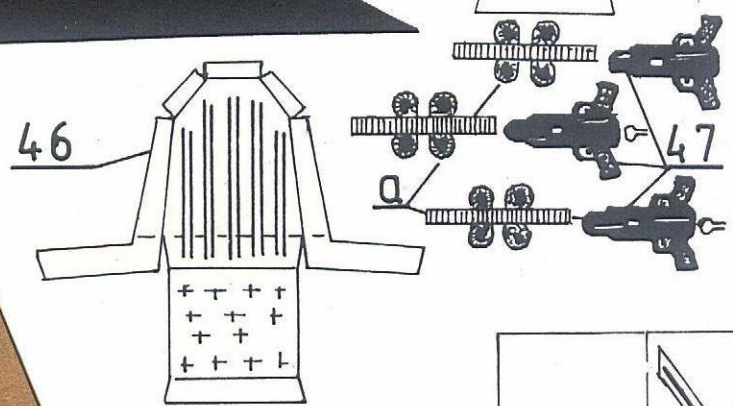
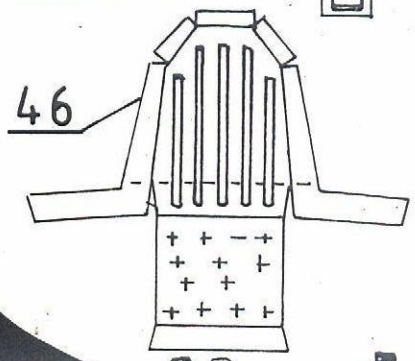
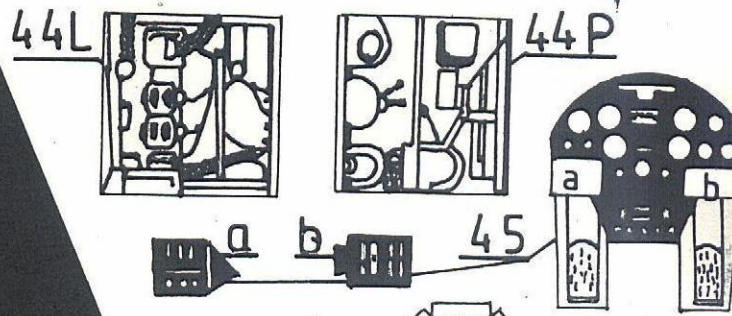
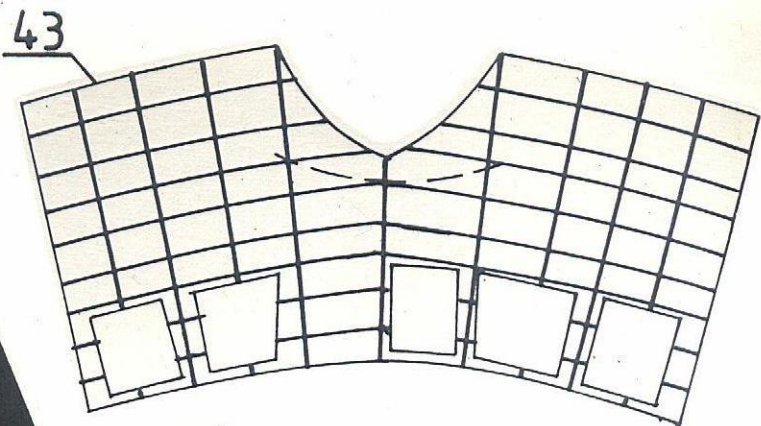
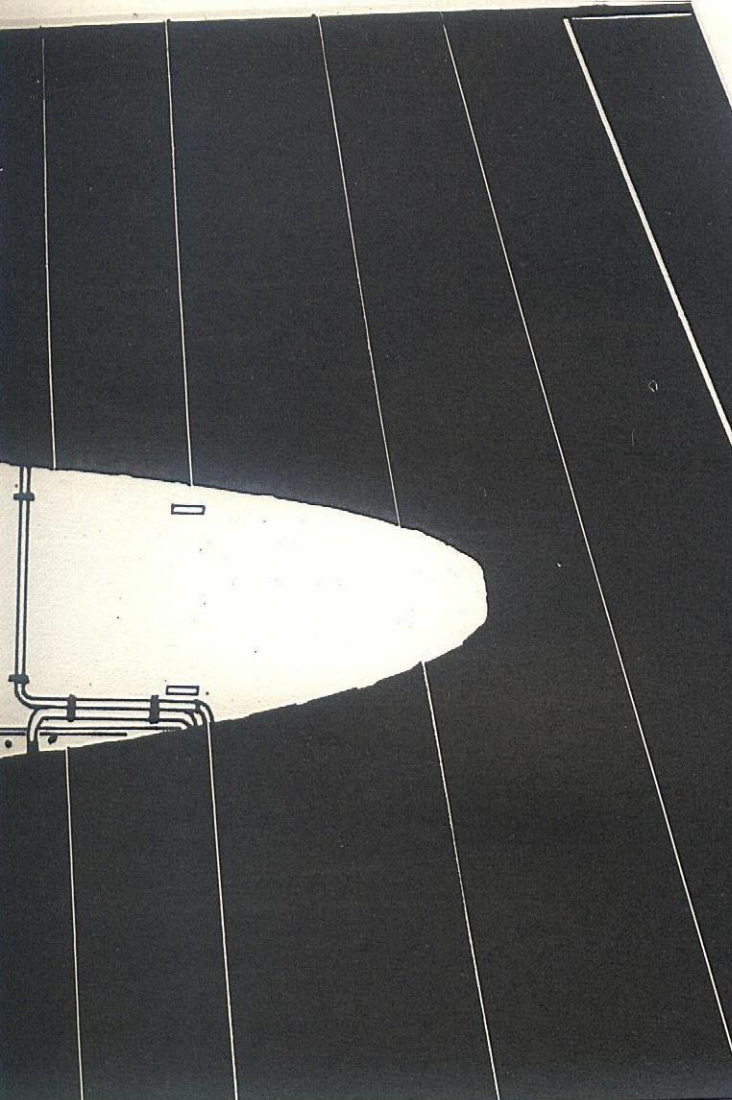

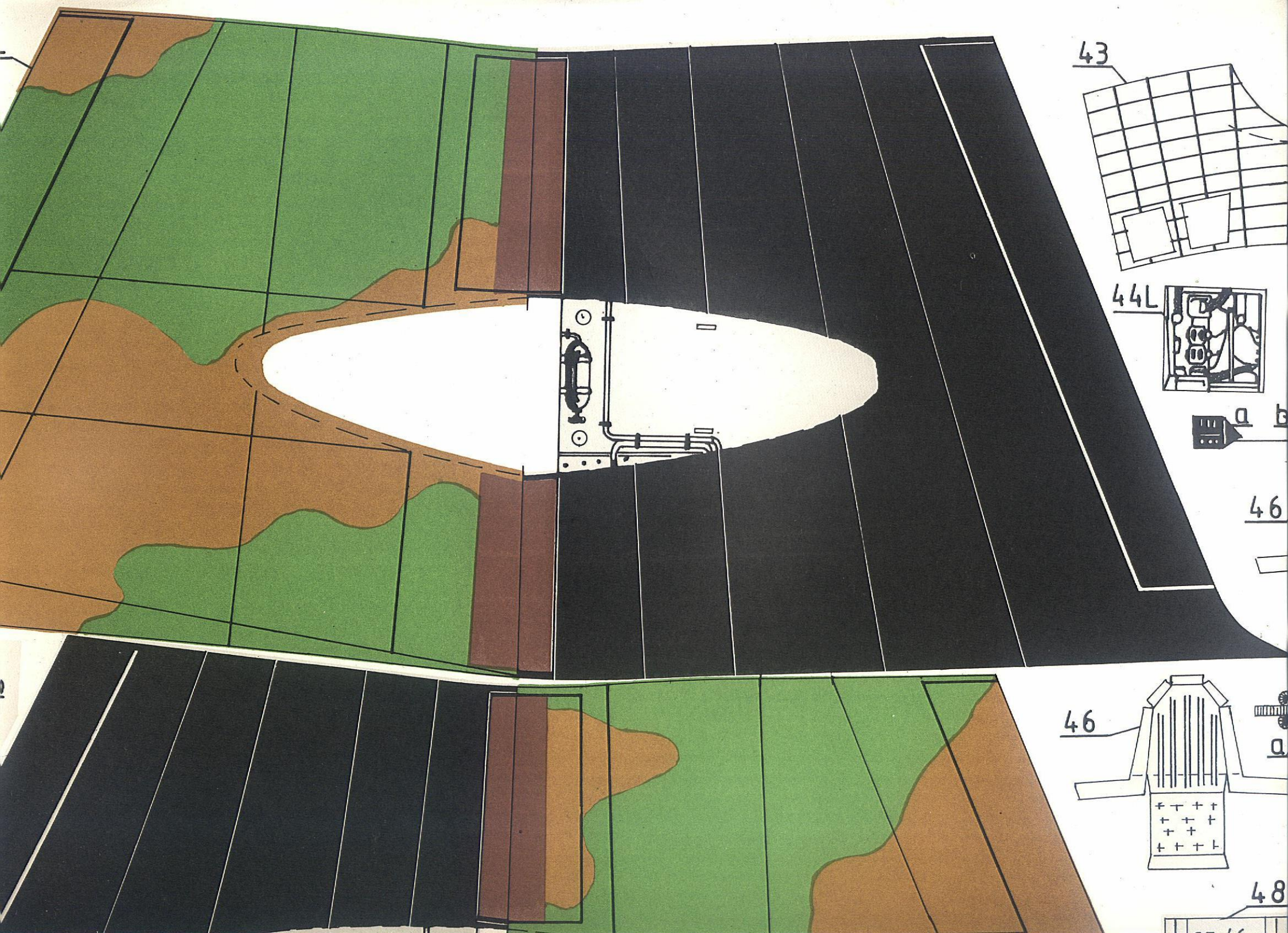

43

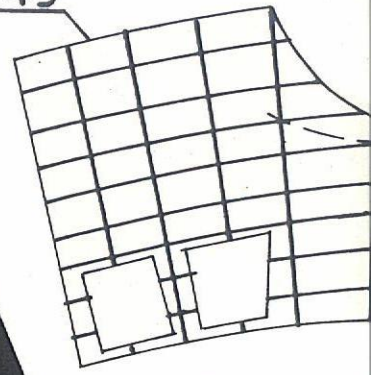

44L

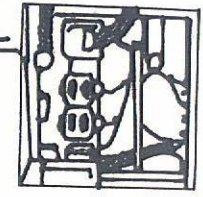

46

46

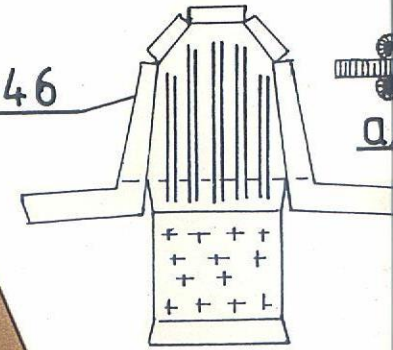

48

16b

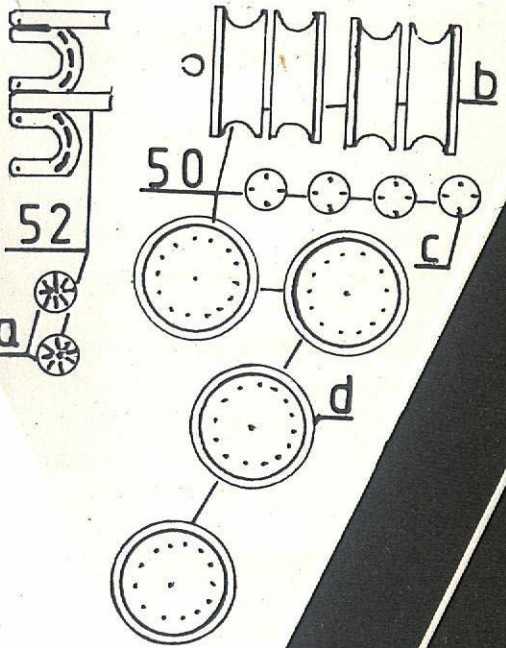
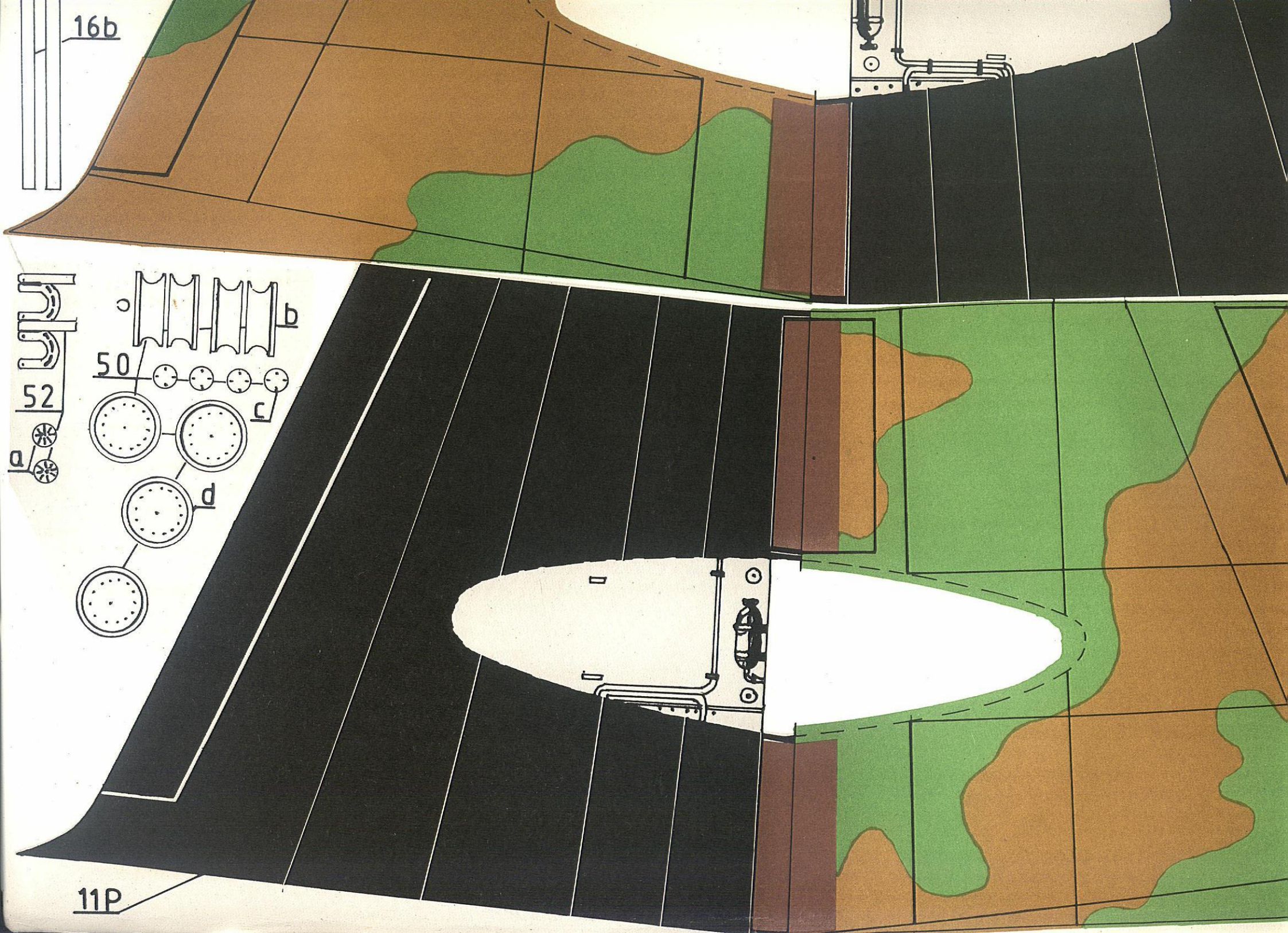

11P

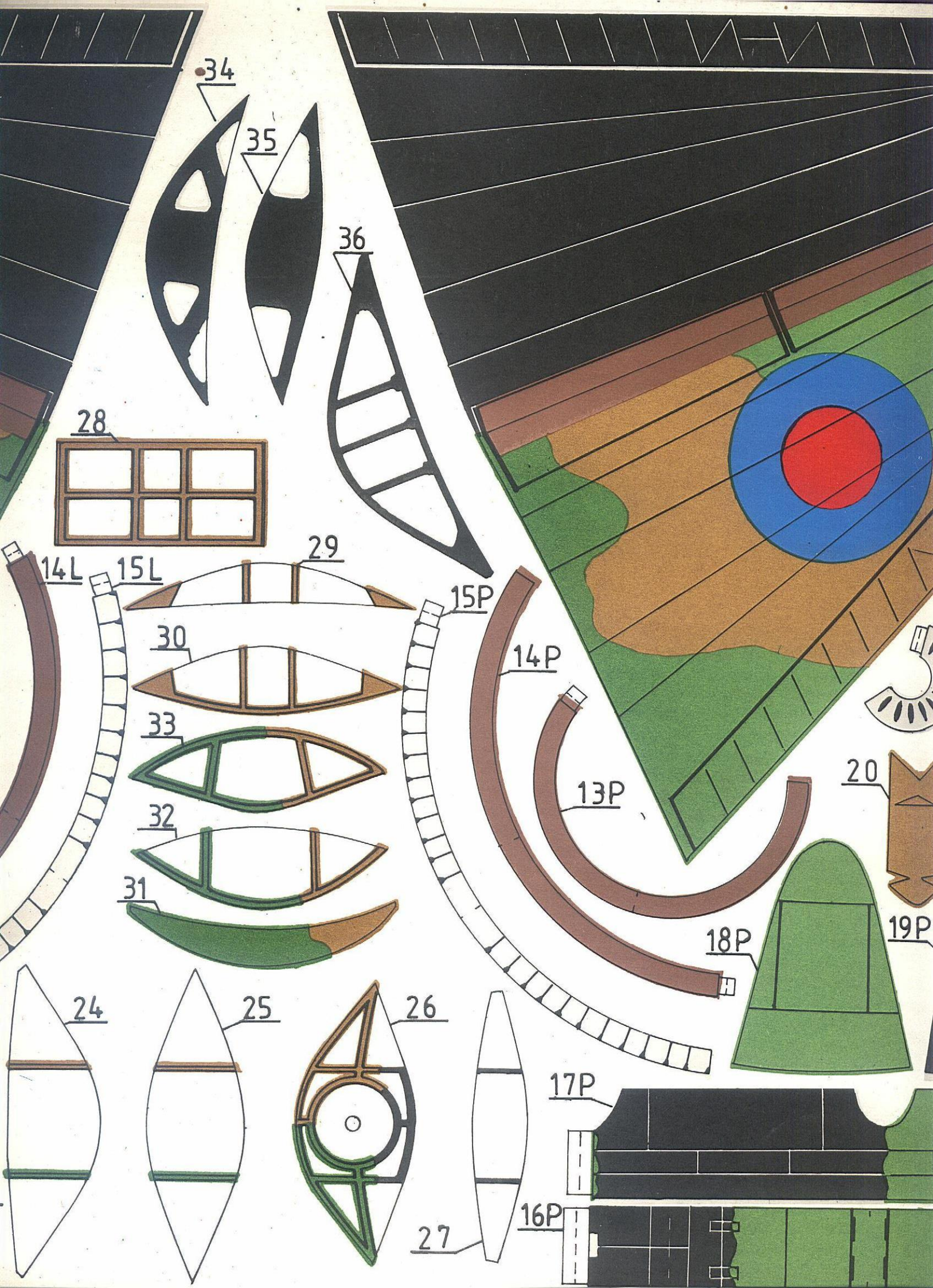



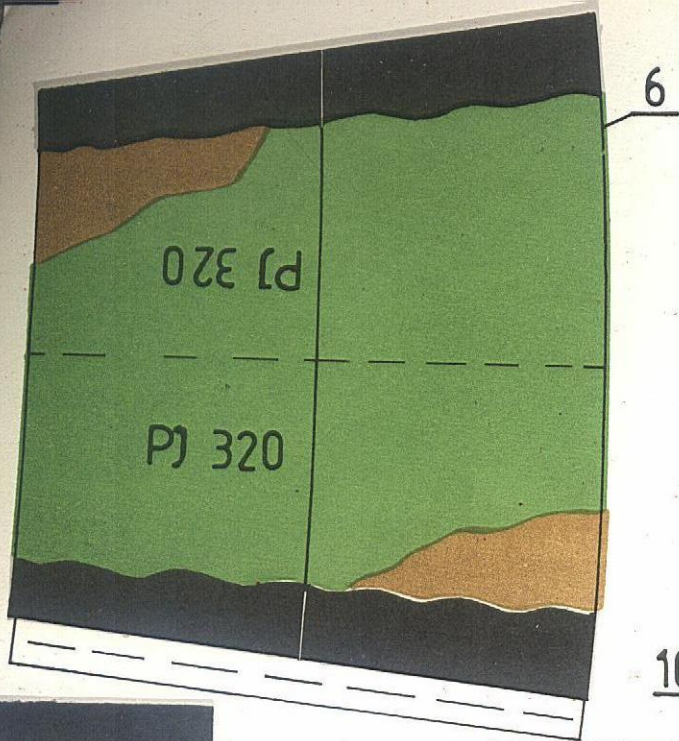

10P

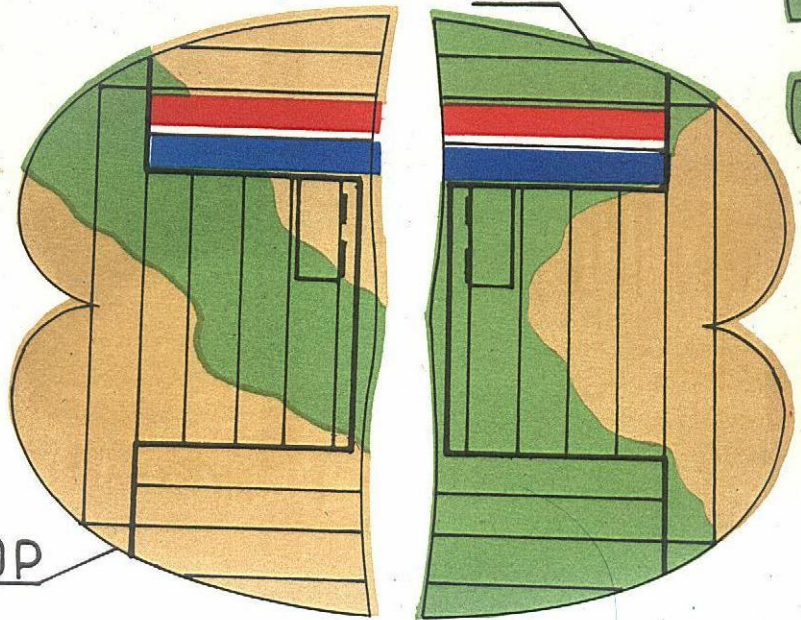

38

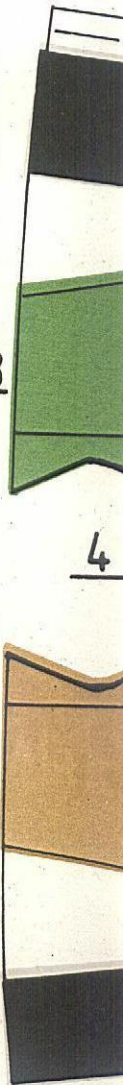
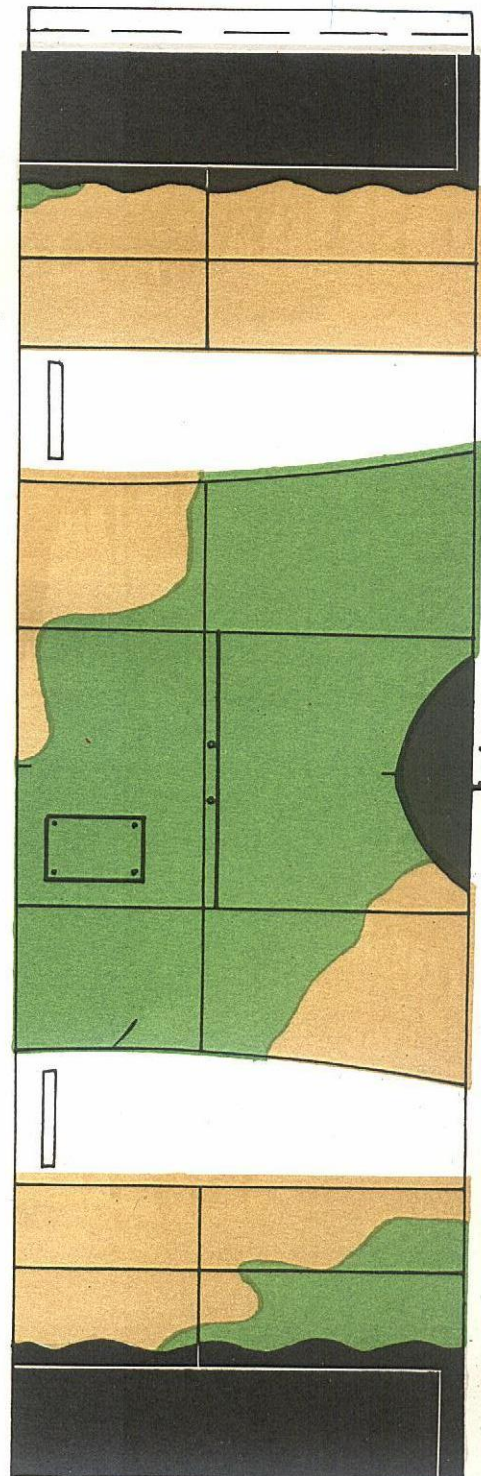
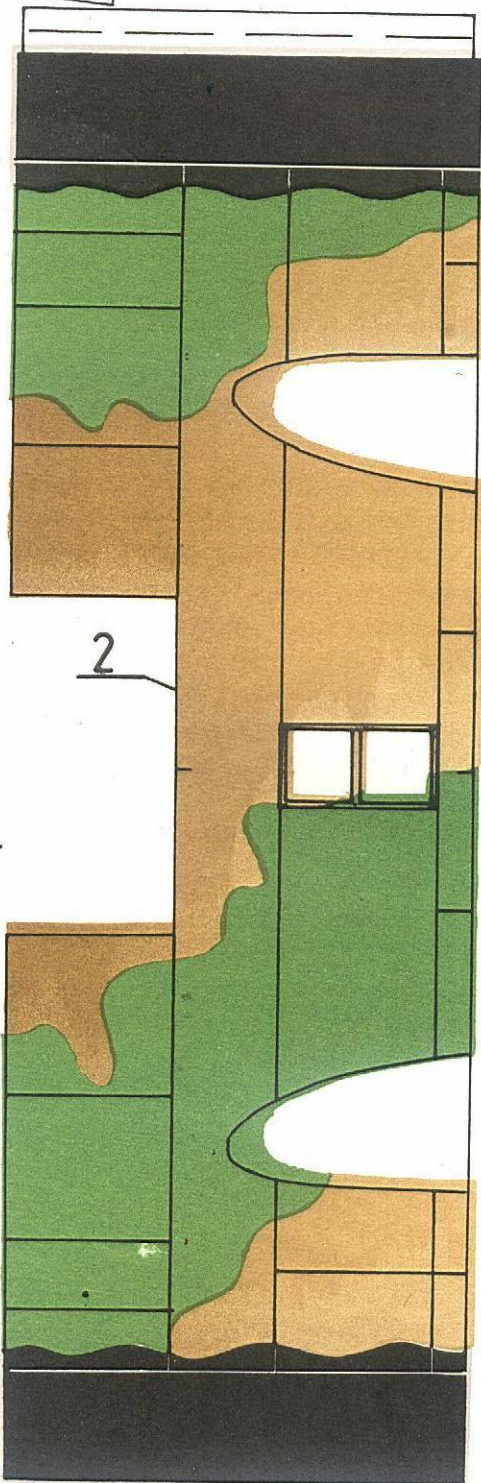
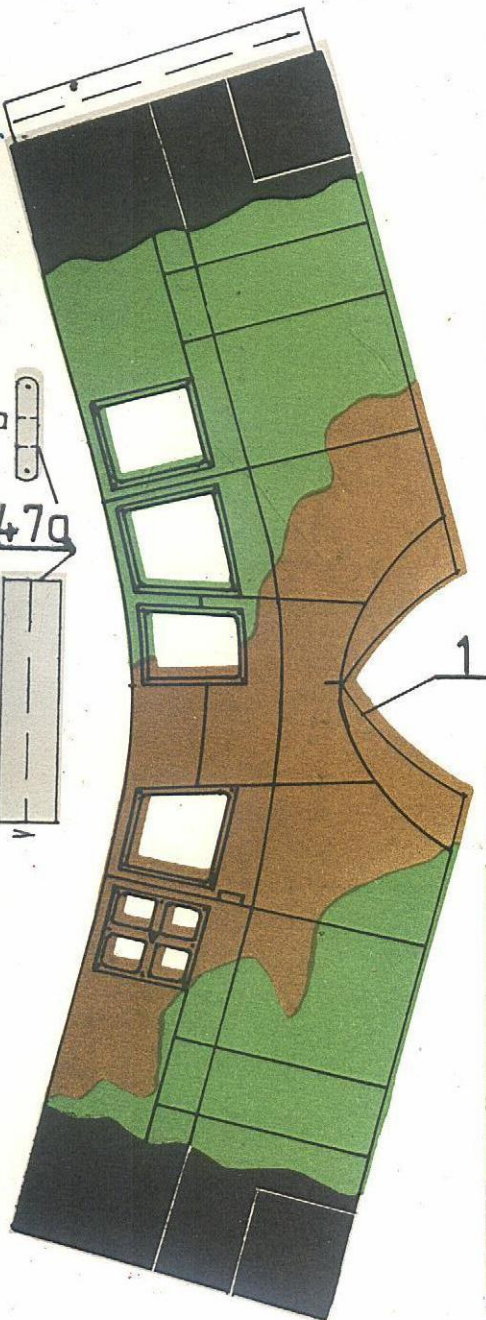



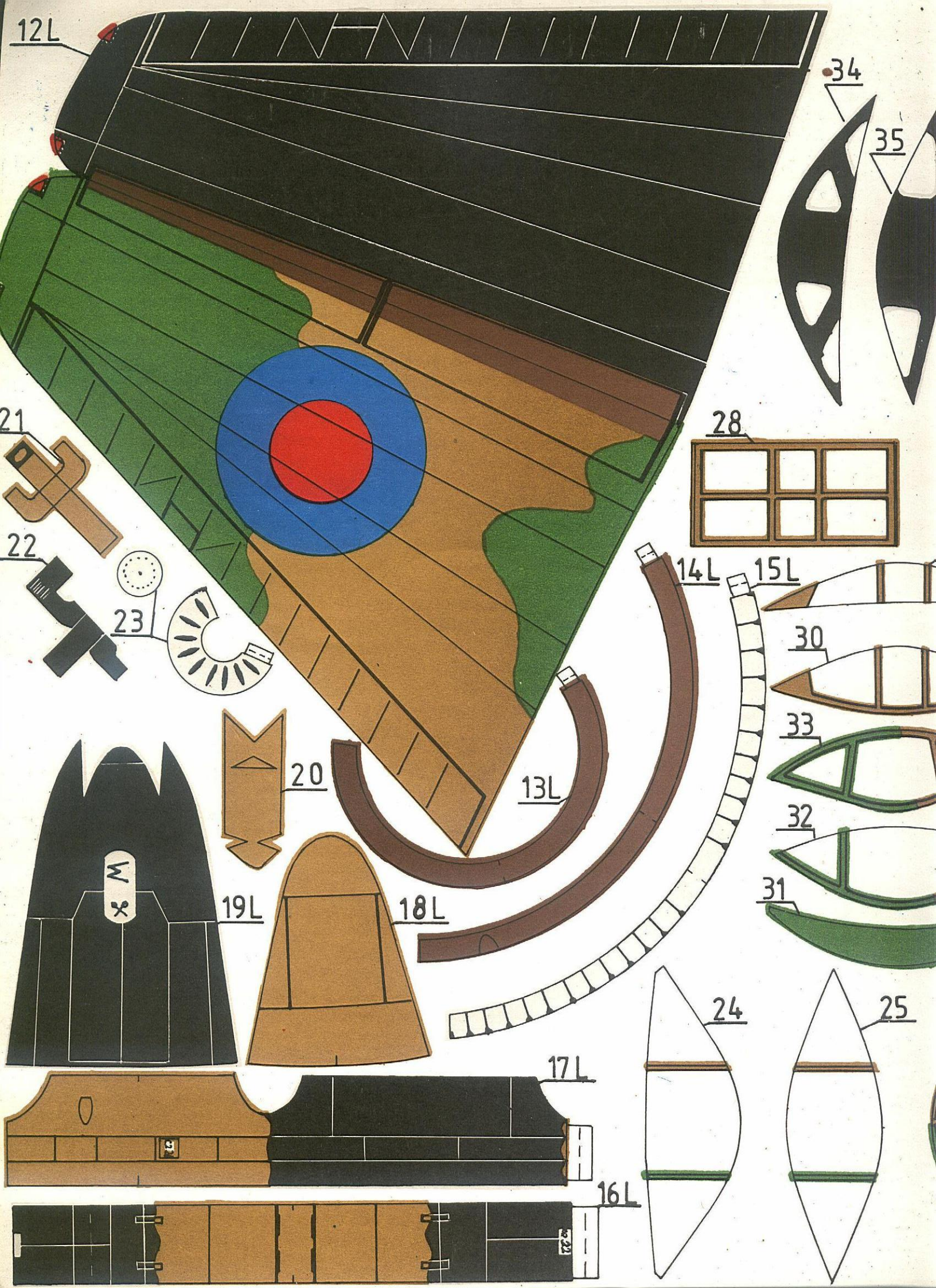

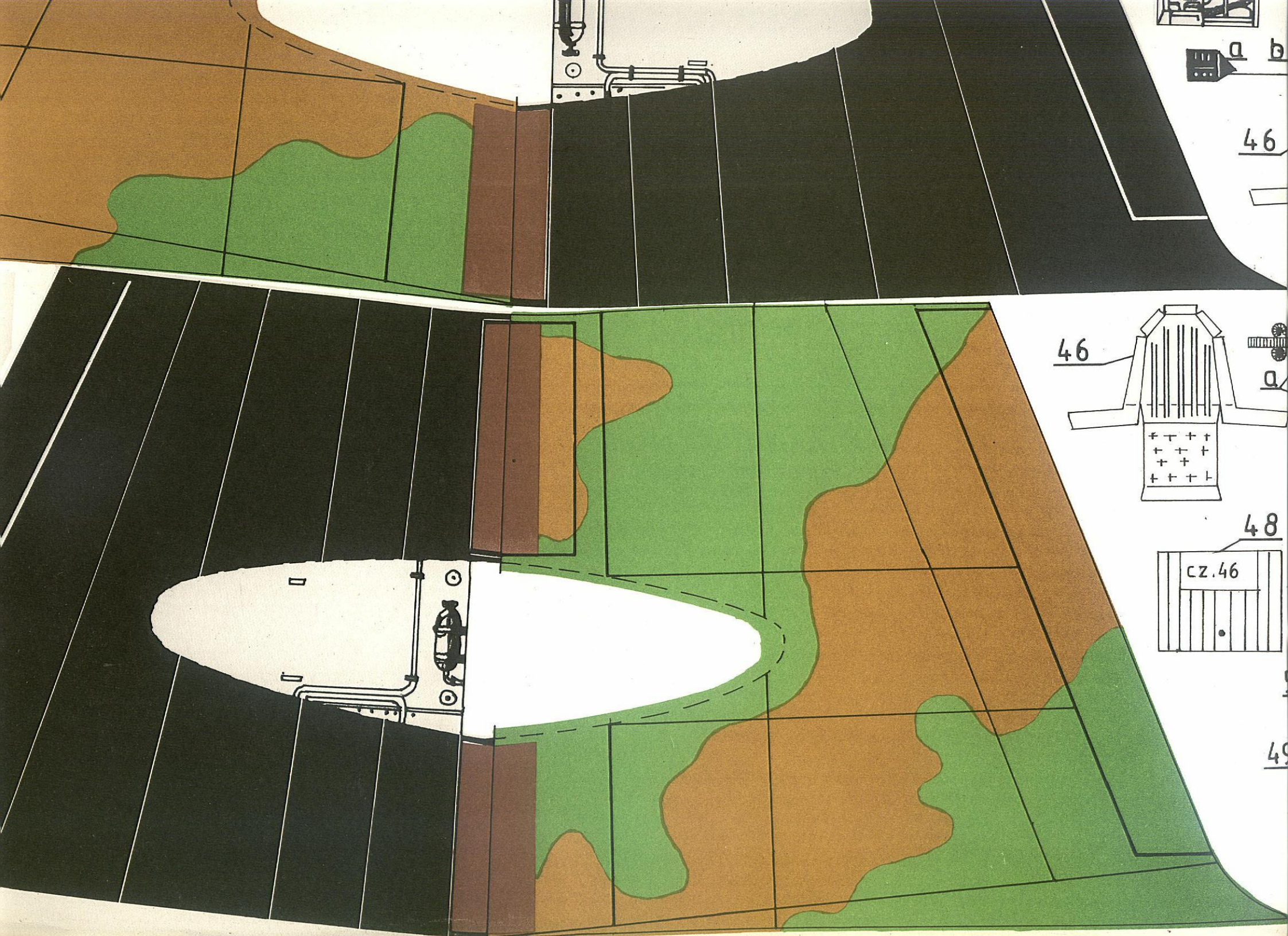

a b

46

46

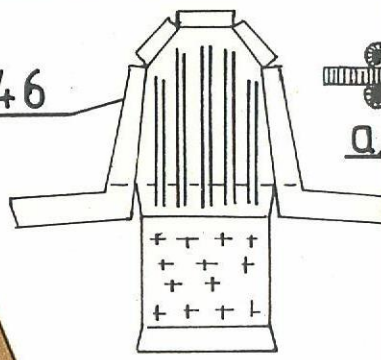

48

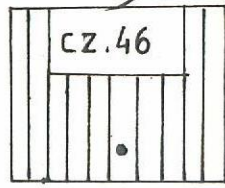

49

16a

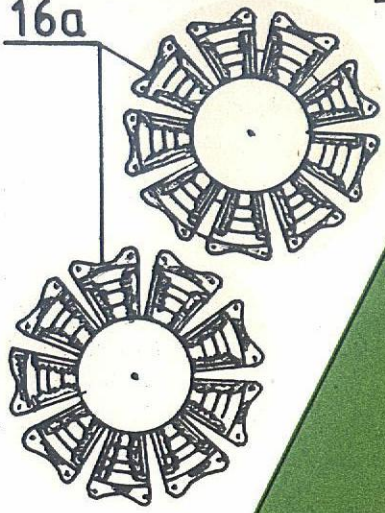

11L

16b

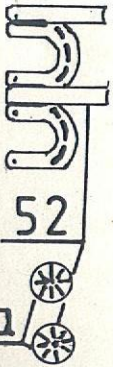

52

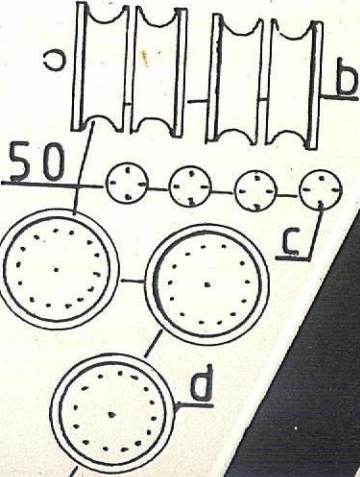

50

b

c

d

