

CURTISS SB2C-4 Helldiver

model kartonowy
1
33

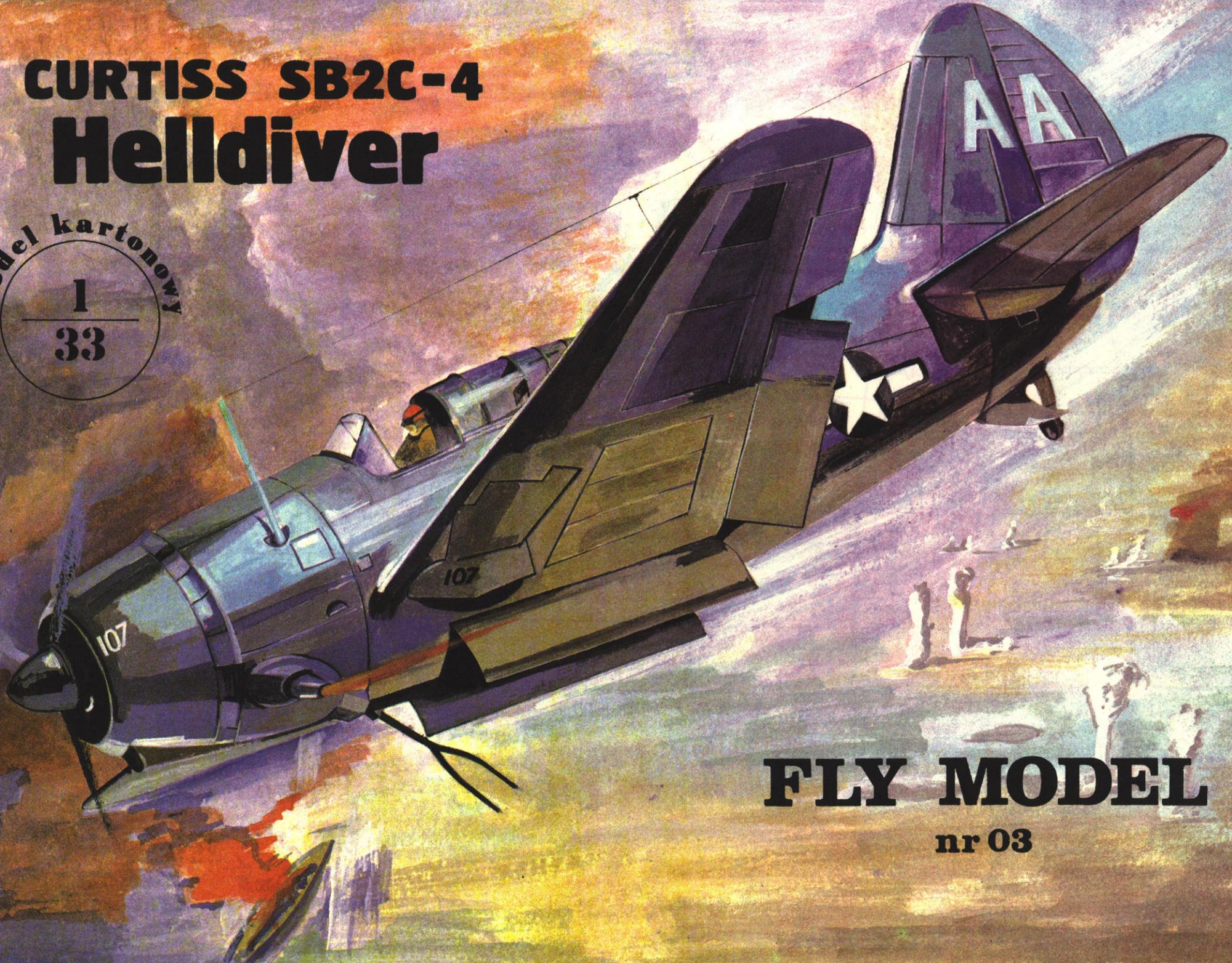

FLY MODEL

nr 03

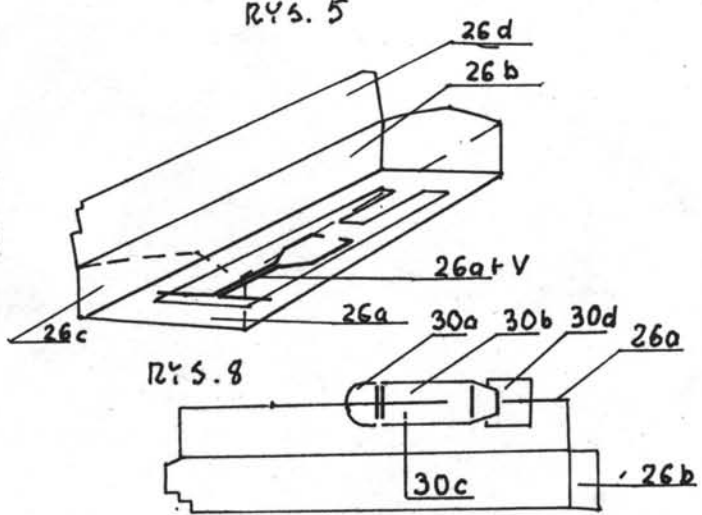
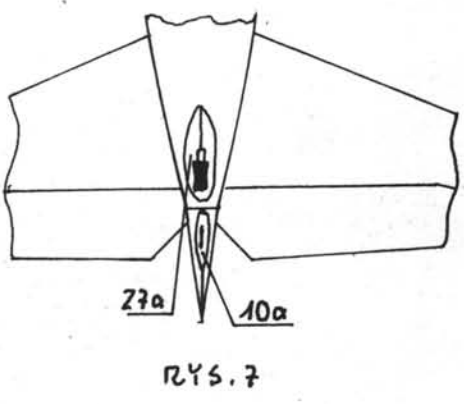
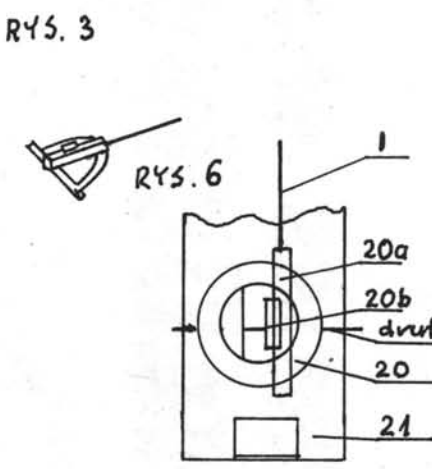
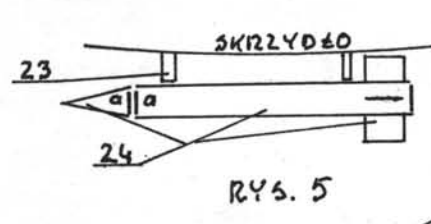
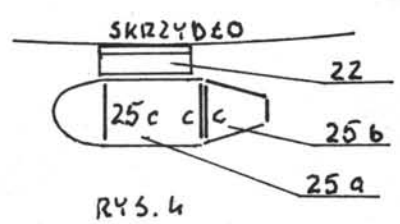
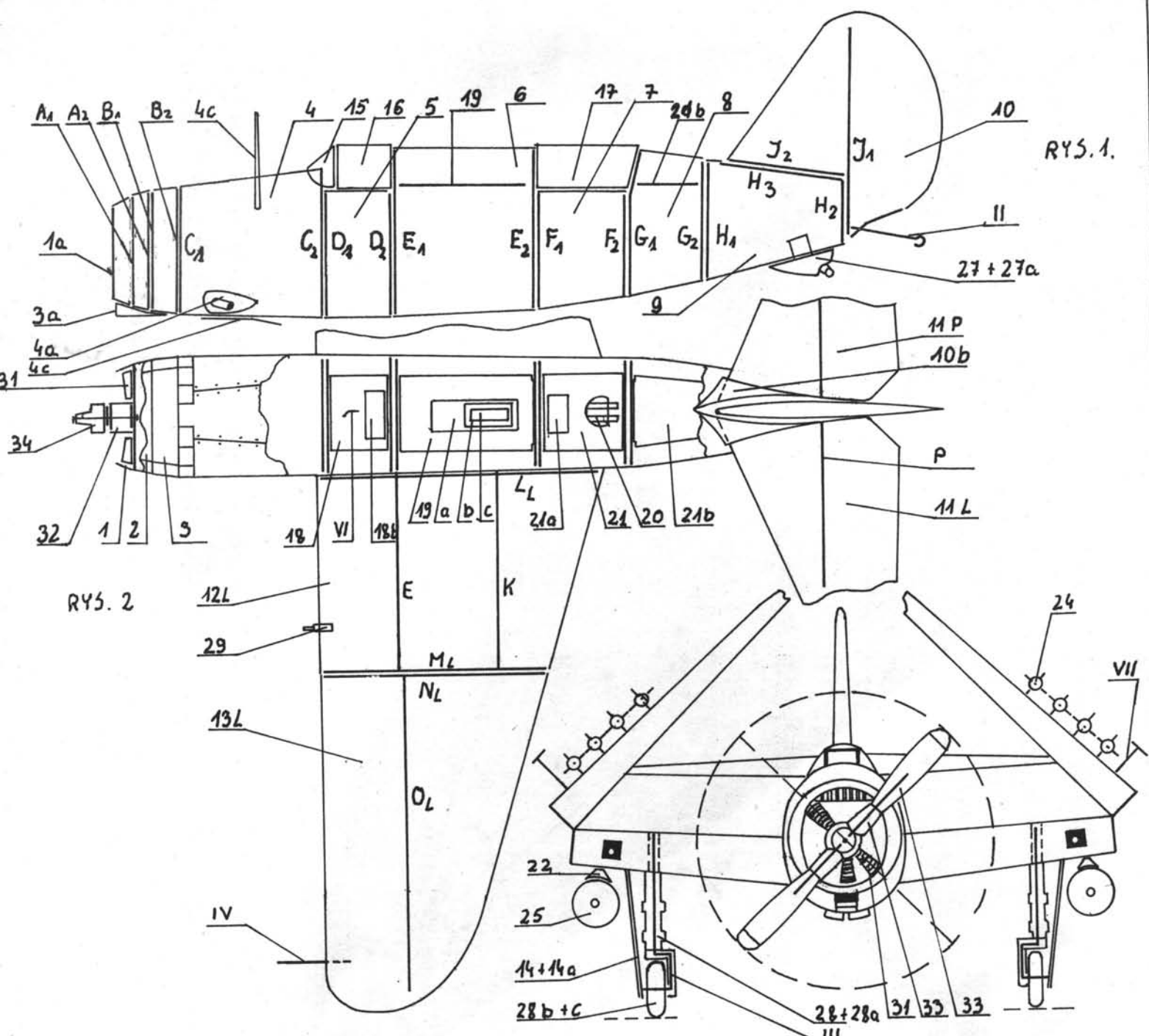

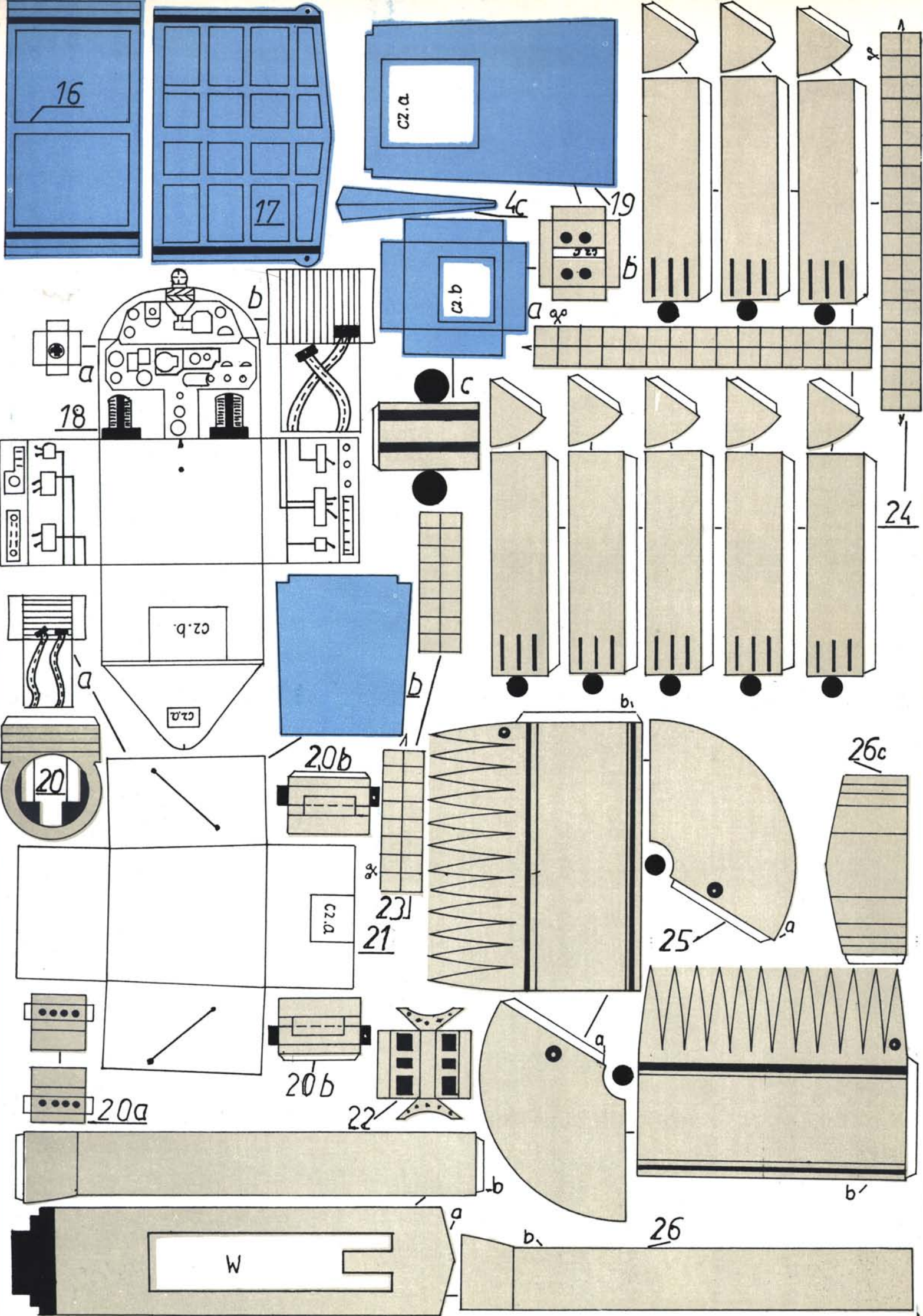

16

17

Cz.a

4c

19

Cz.b

b

a

x

24

18

b

c

b₁

Cz.b

Cz.a

20b

20

Cz.a

21

x

26c

25

a

20a

20b

22

a

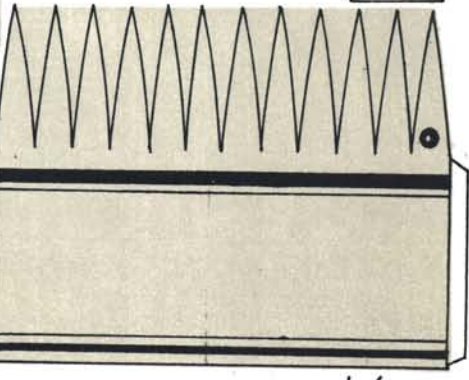

b'

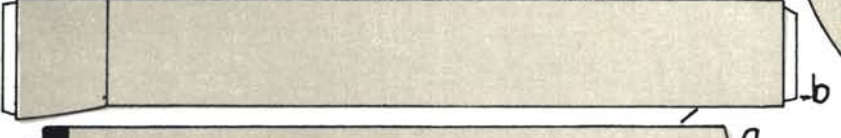

b₁

26

W

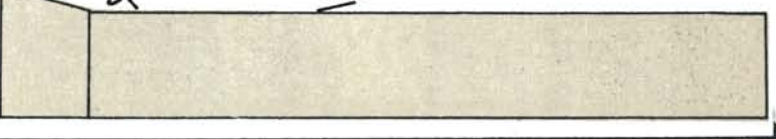

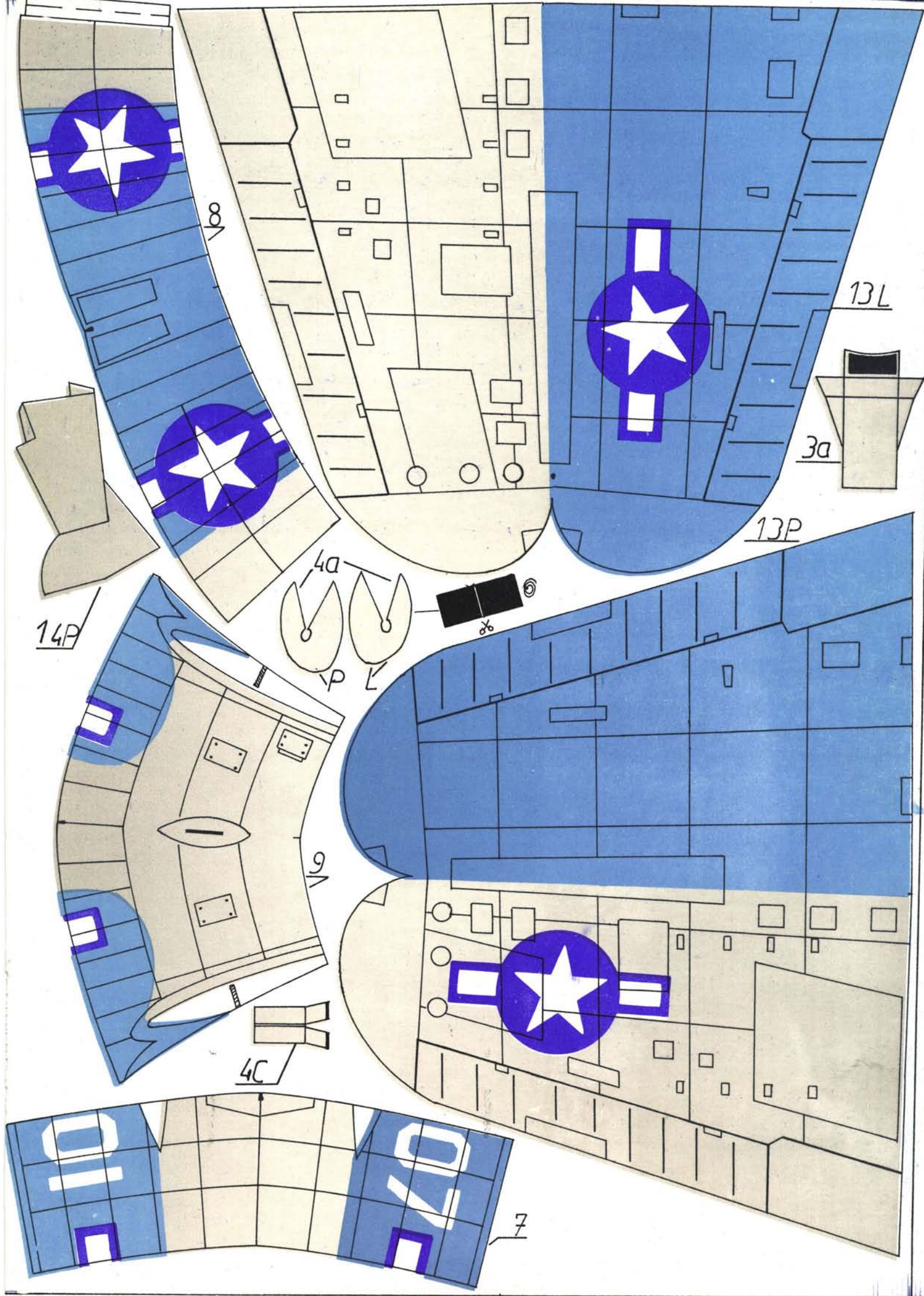

22

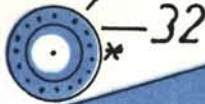
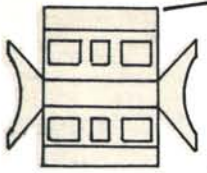

11L

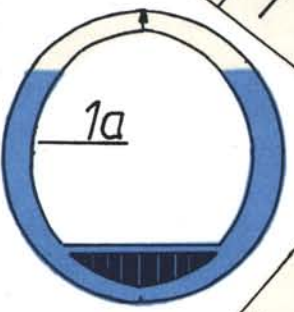
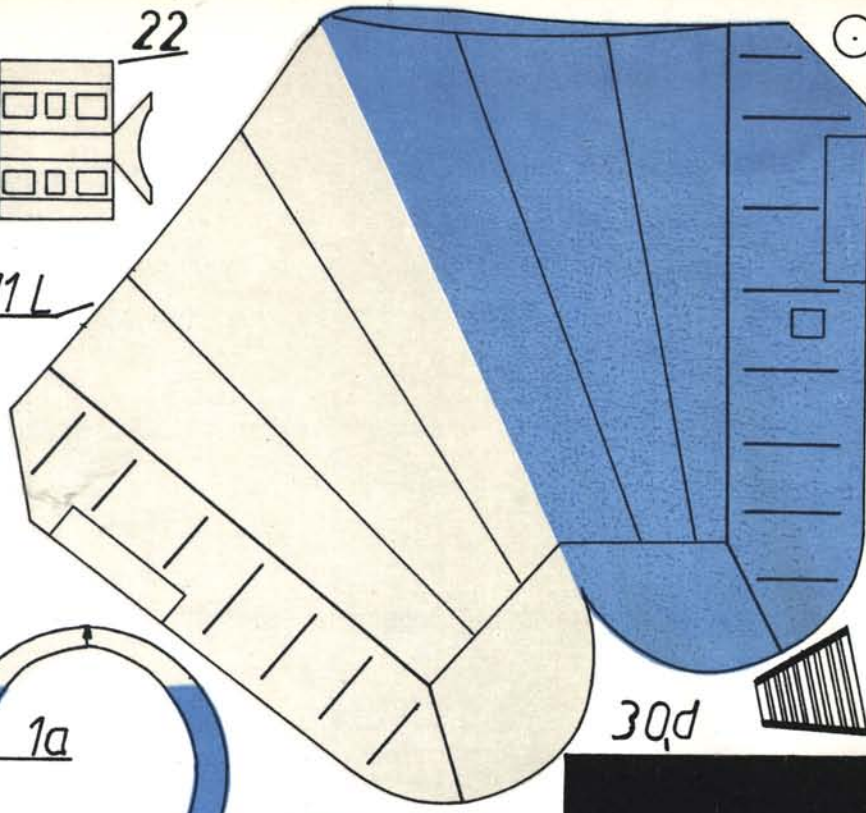

30d



31



11P

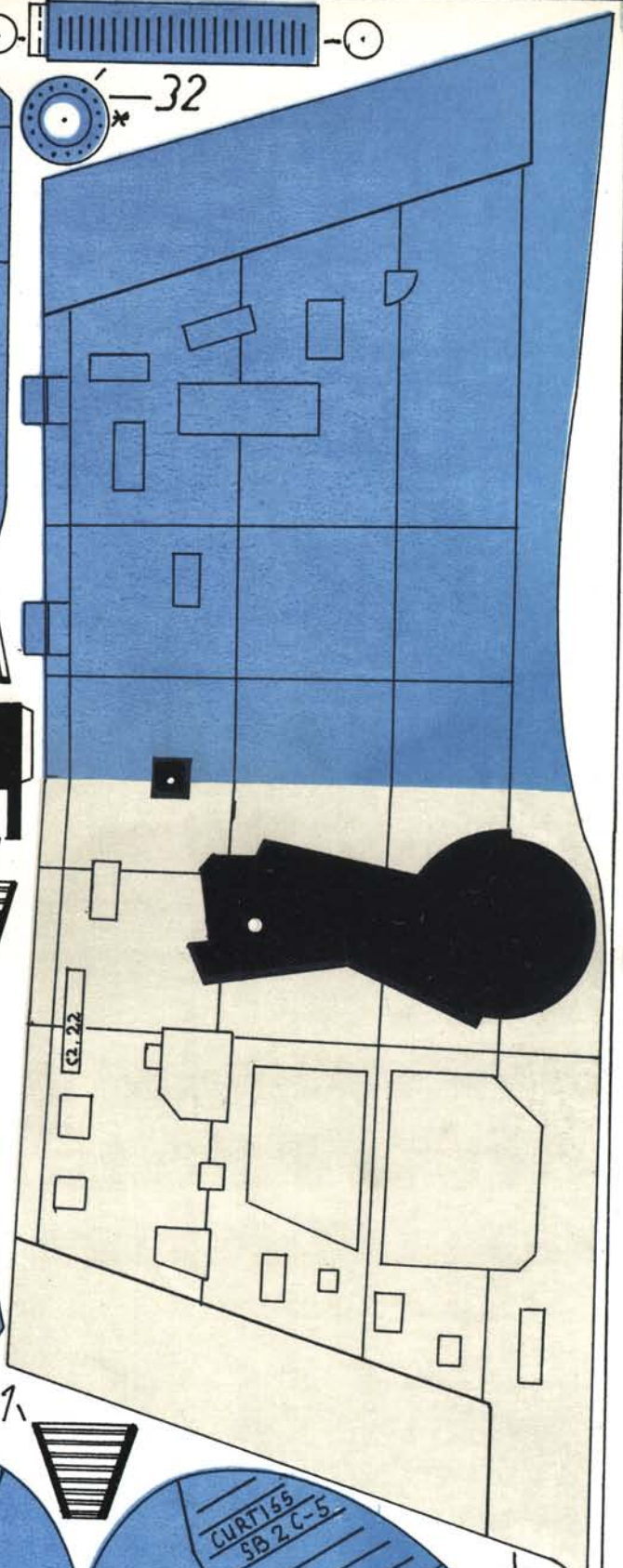
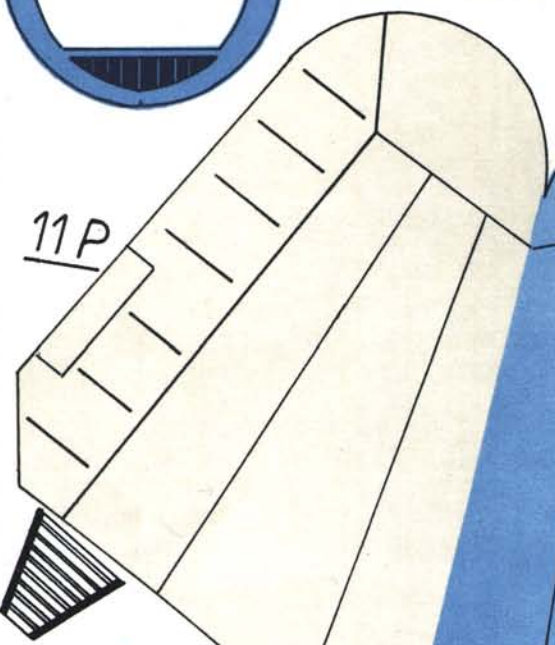

31



12p

4b



15



31



10b



27a

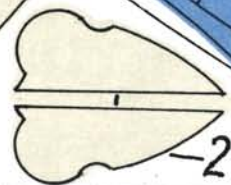

10

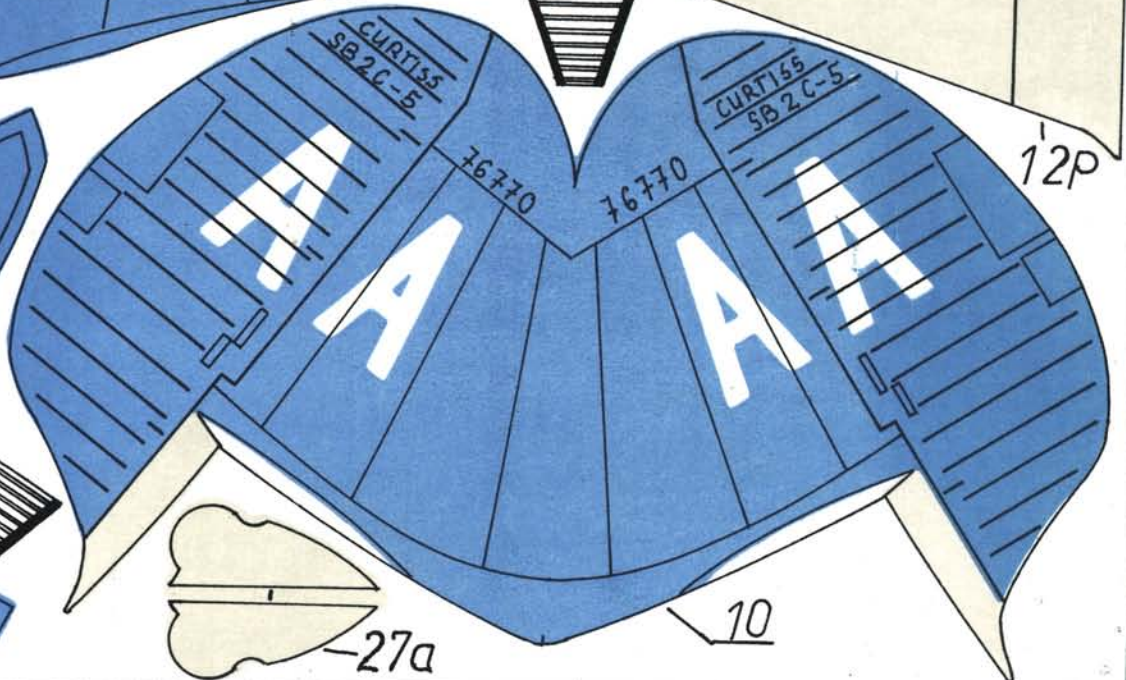

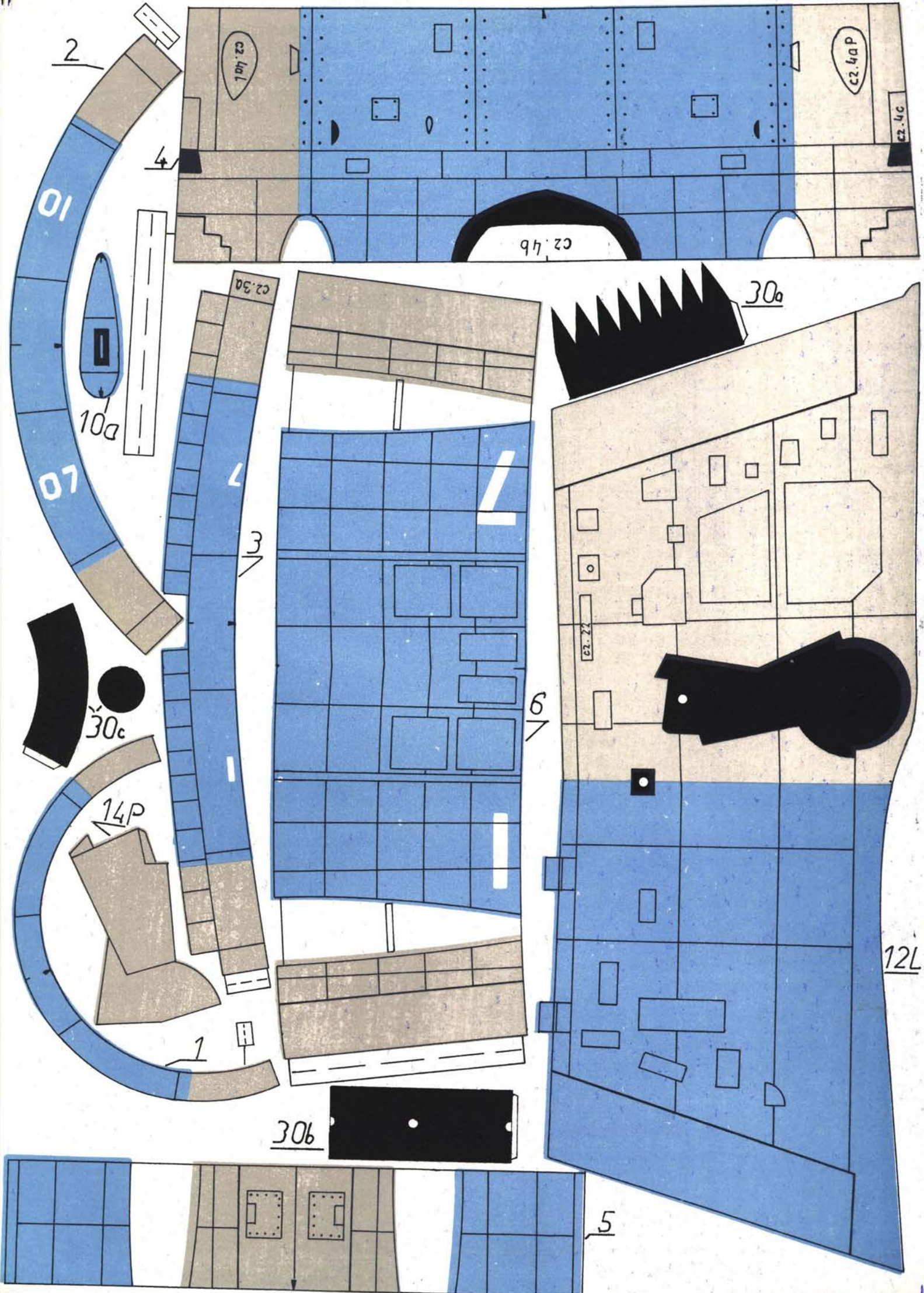

2

10

07

10a

30c

14P

1

30b

5

4

c2.3a

7

3

6

c2.4aL

c2.4aP

c2.4c

c2.4b

30a

12L

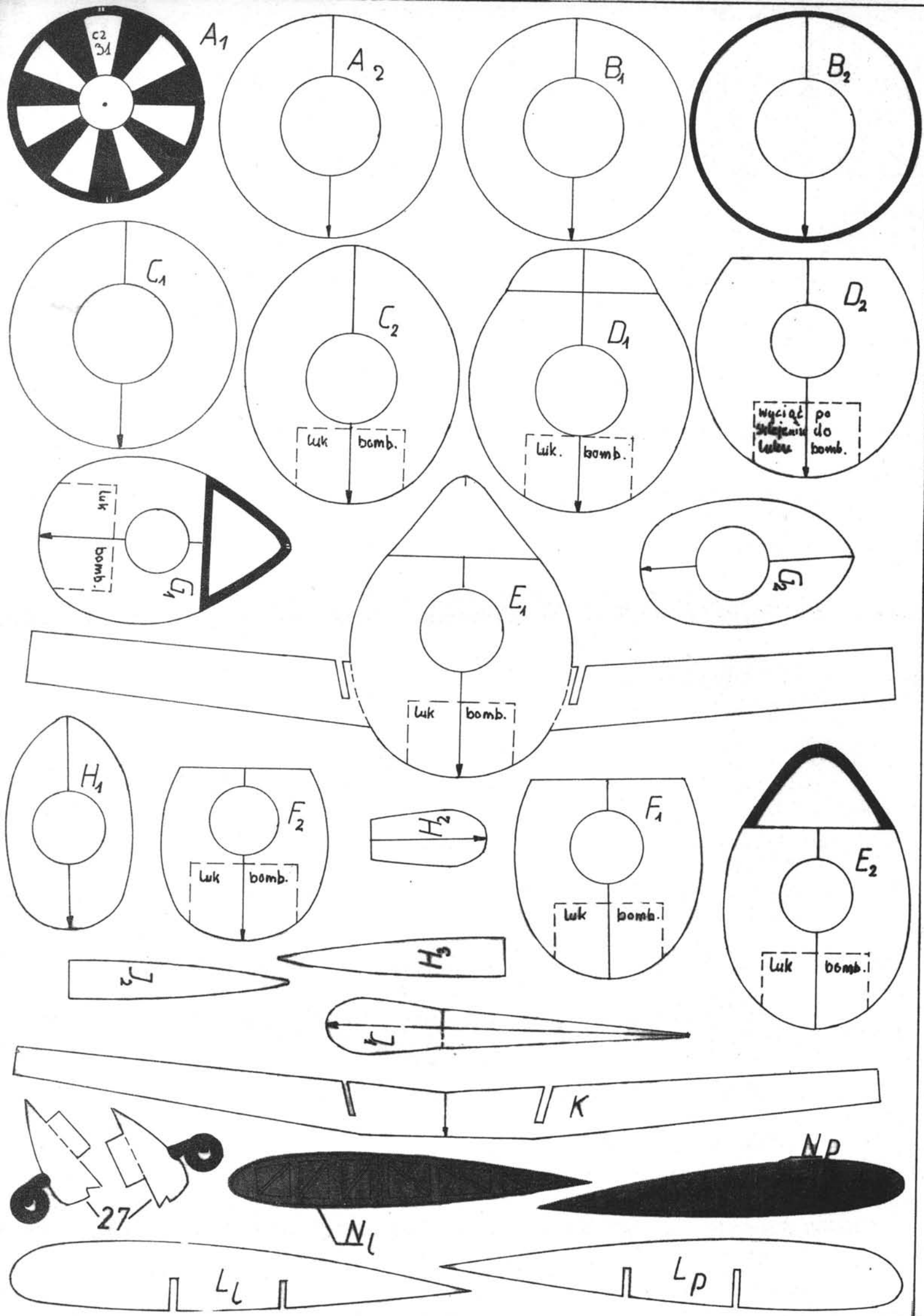

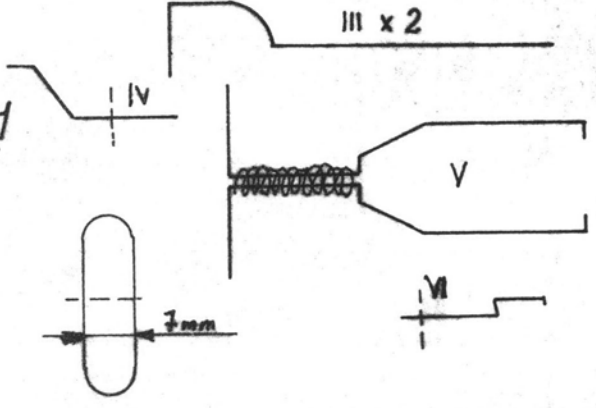
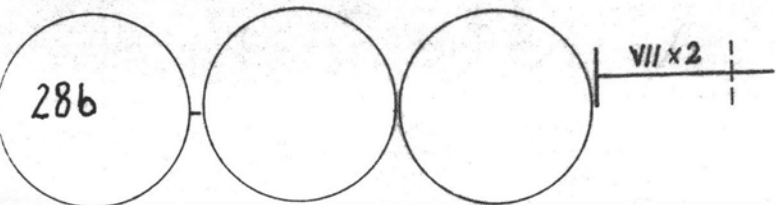
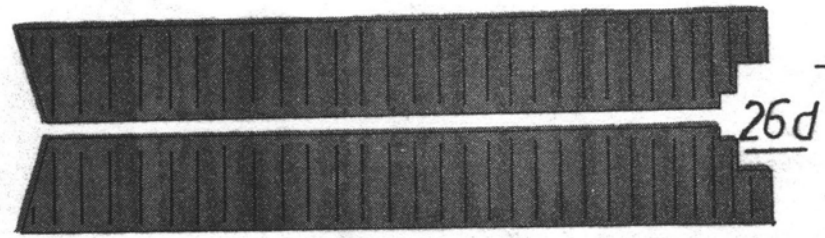
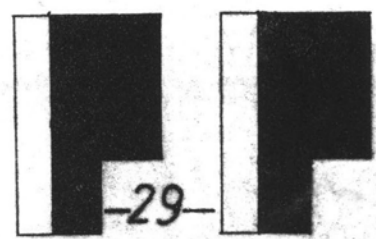
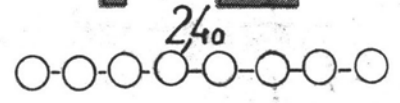
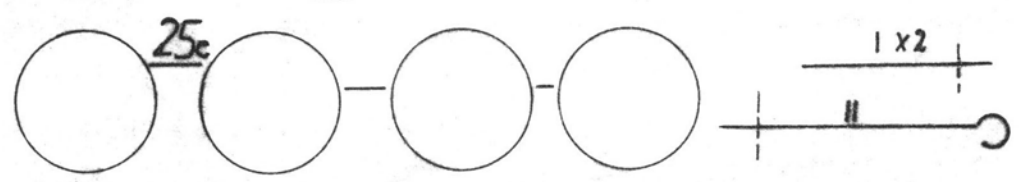
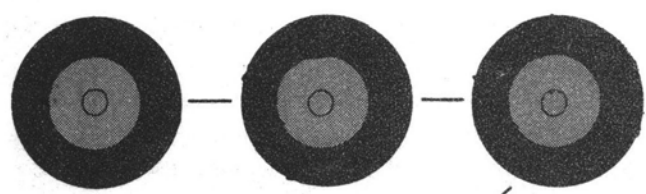
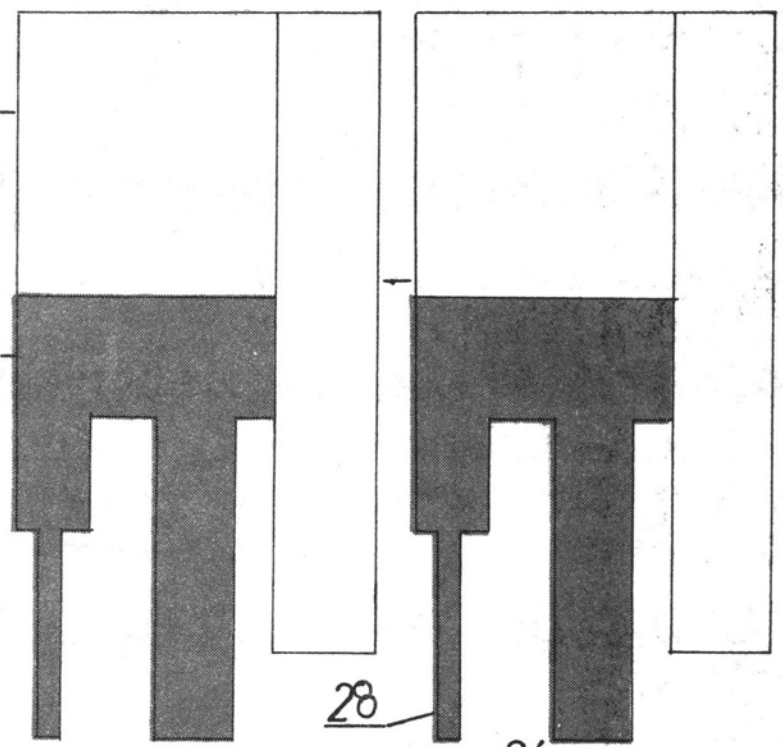
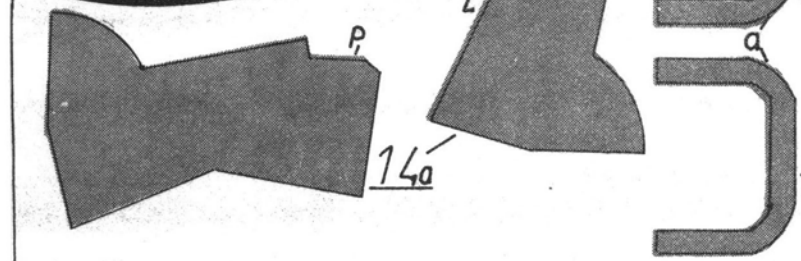
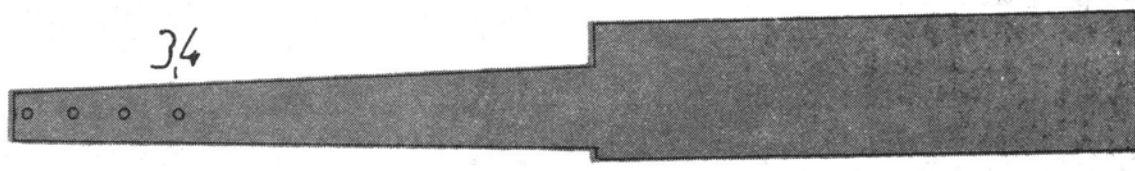
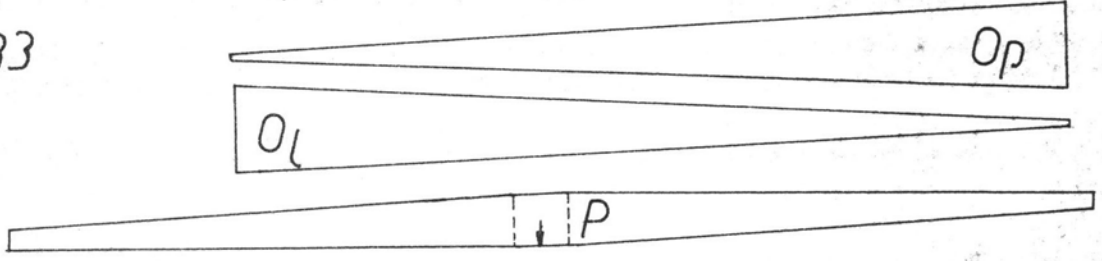
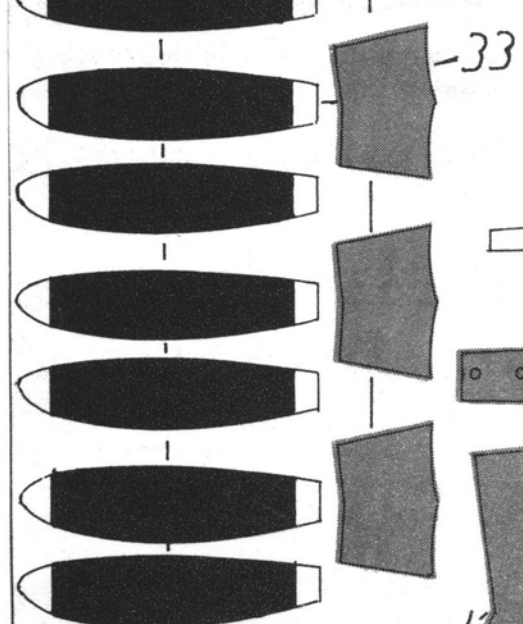
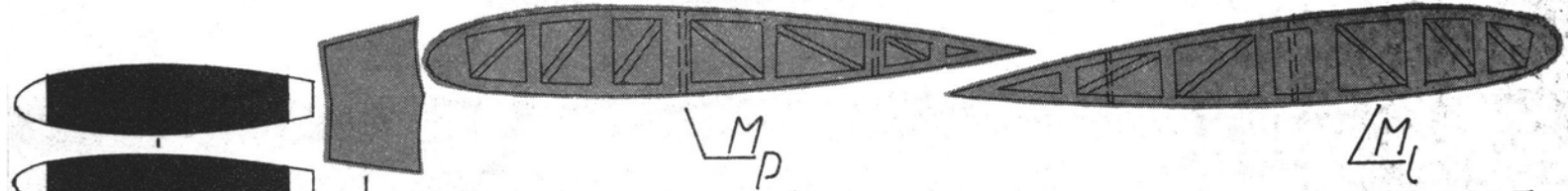

III x 2