

# PZL-101 GAWRON



## STOPIEŃ TRUDNOŚCI

1

2

3

## WYMIARY MODELU

DŁUGOŚĆ ..... 28 cm

ROZPIĘTOŚĆ ..... 39 cm

WYSOKOŚĆ ..... 10 cm

**skala 1:33**

# GPM<sup>®</sup>

<http://www.gpm.pl>

NR KAT. **171**

SERIA "C"

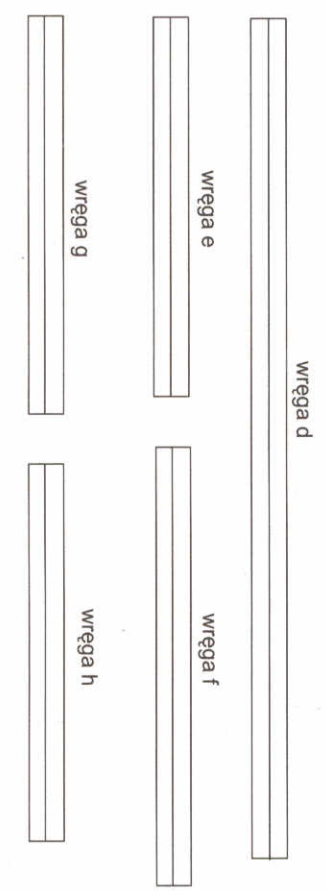
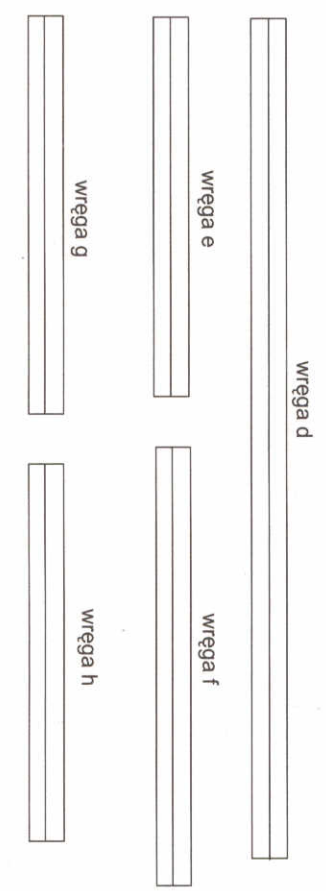
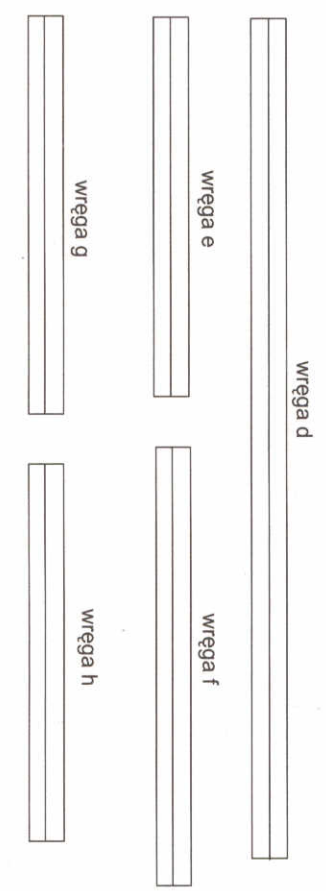
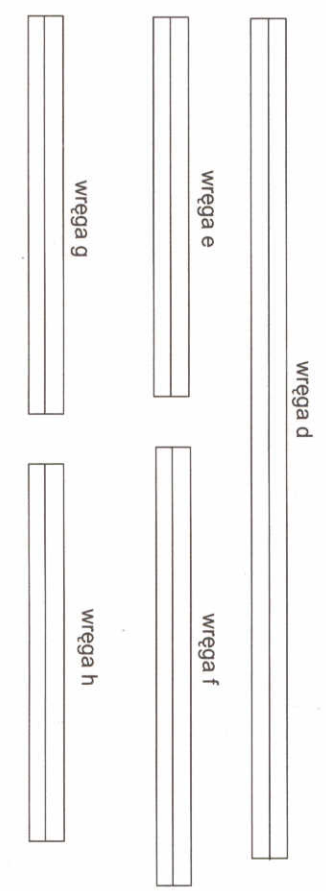
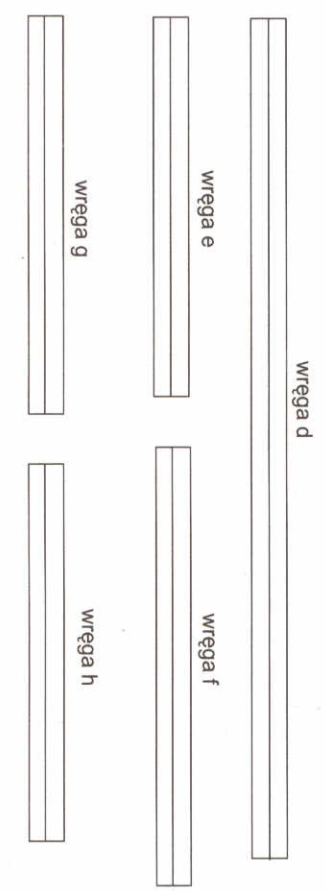
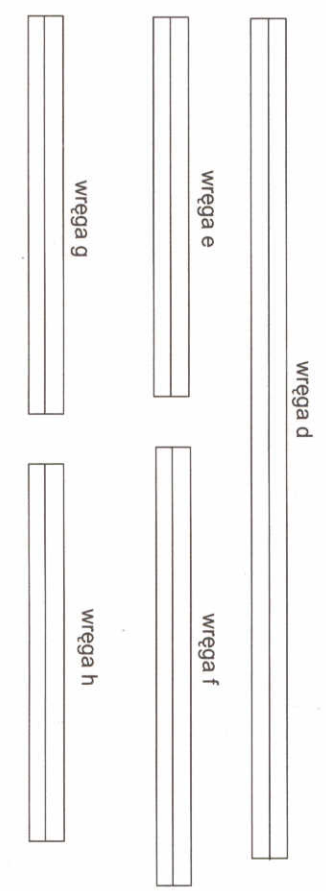
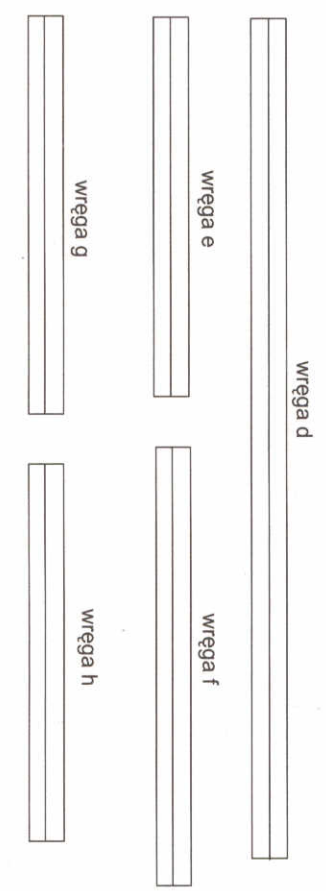
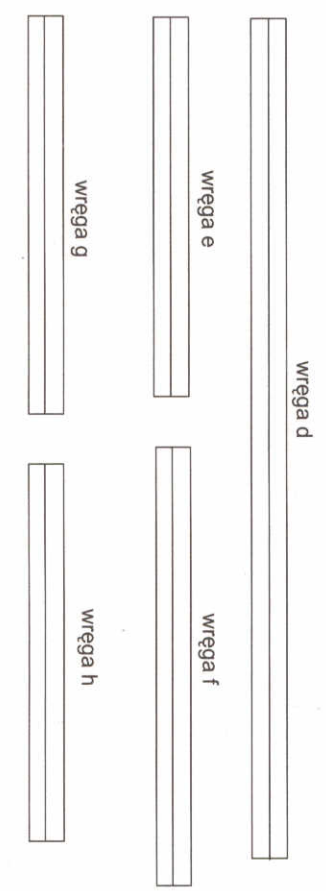
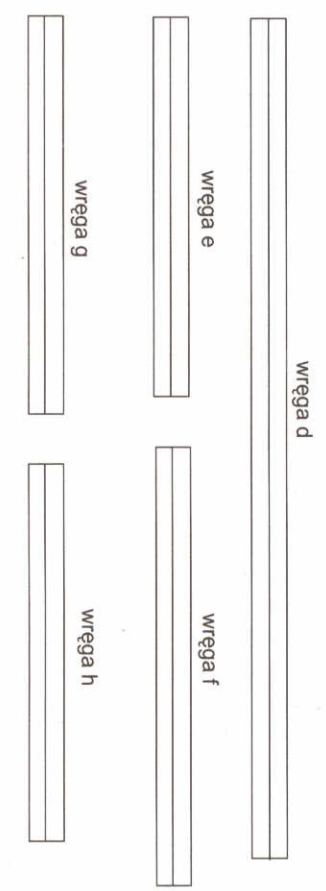
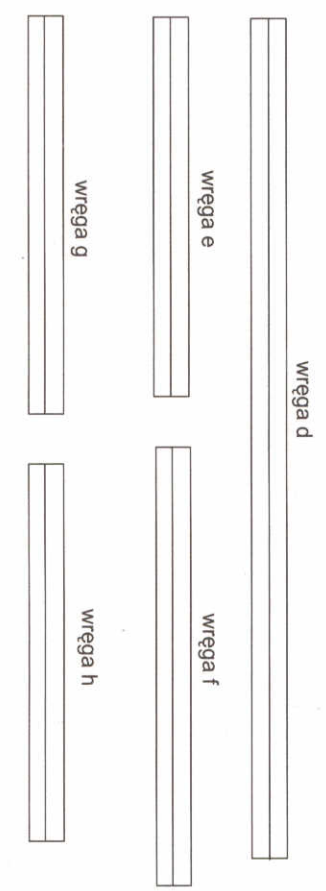
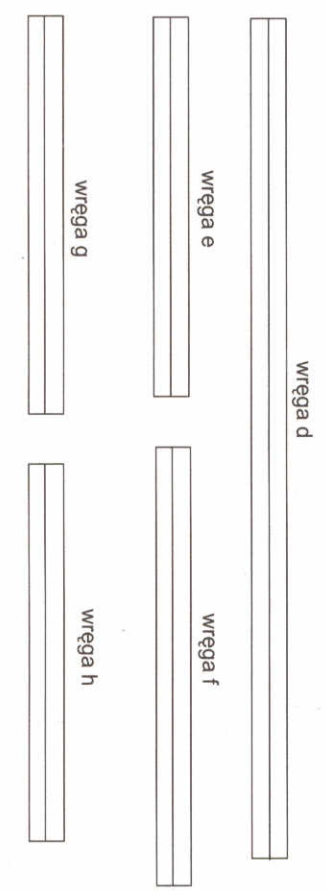
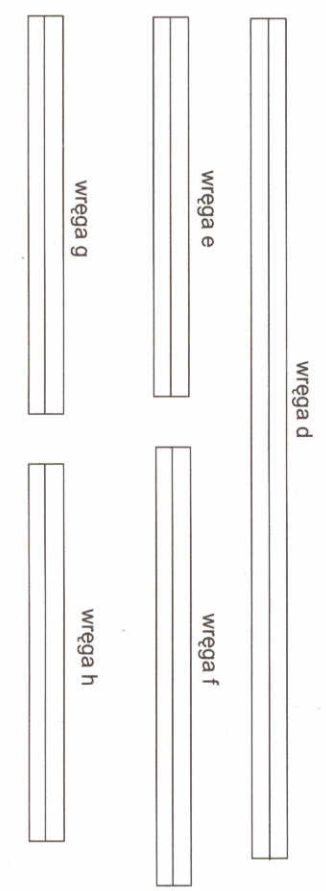
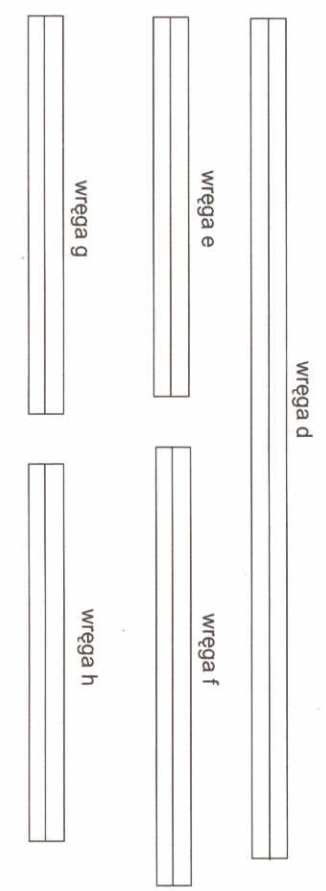
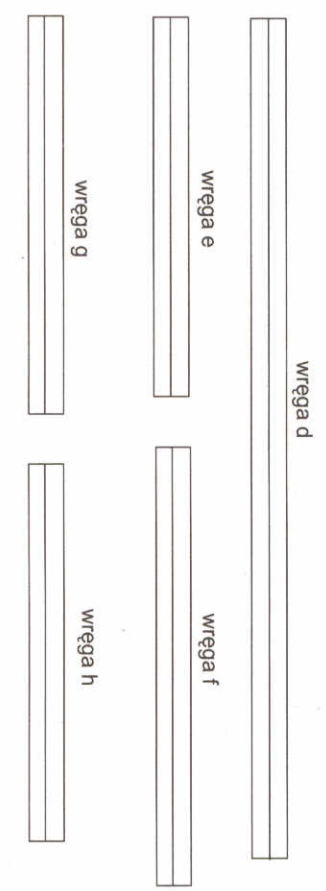
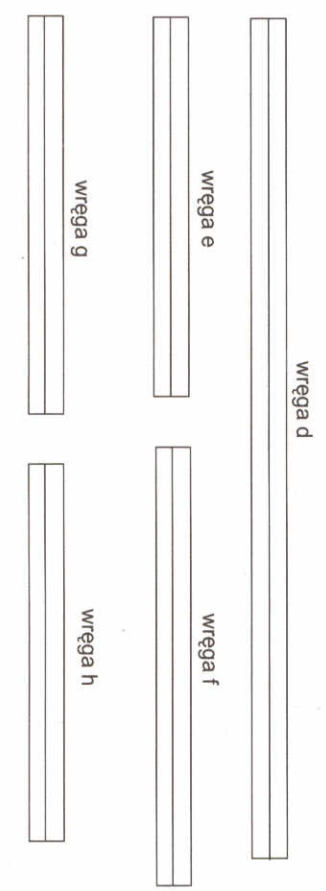
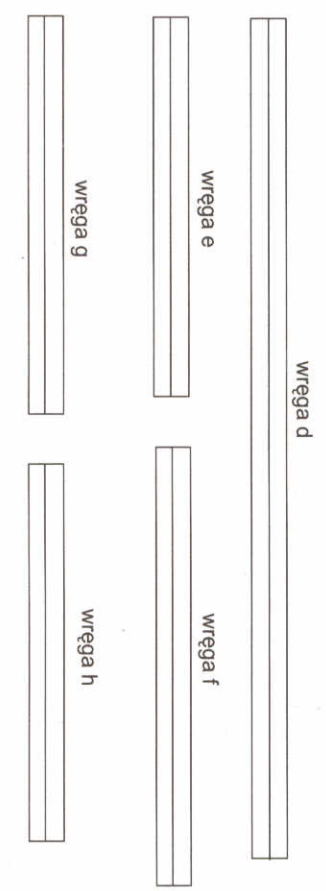
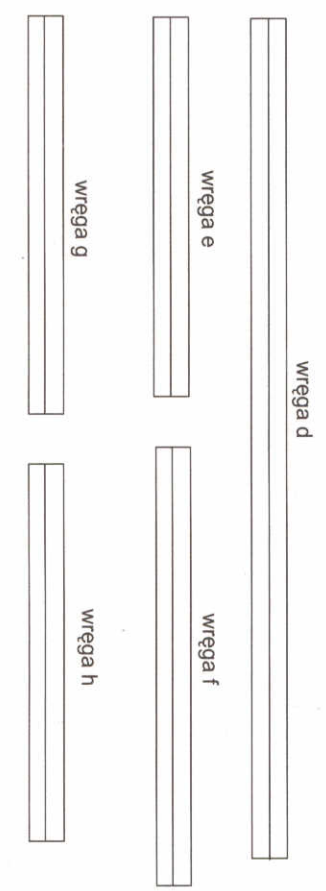
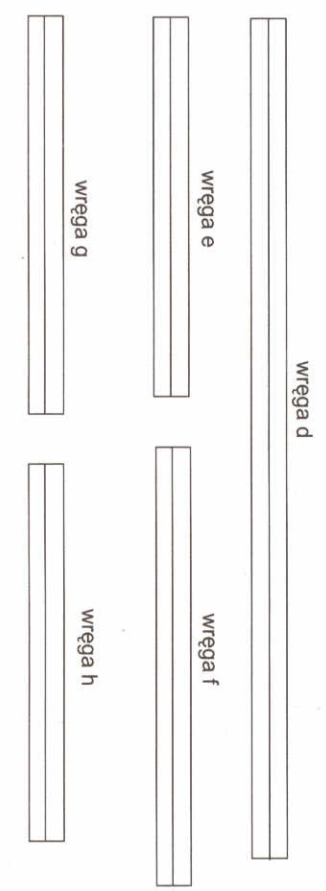
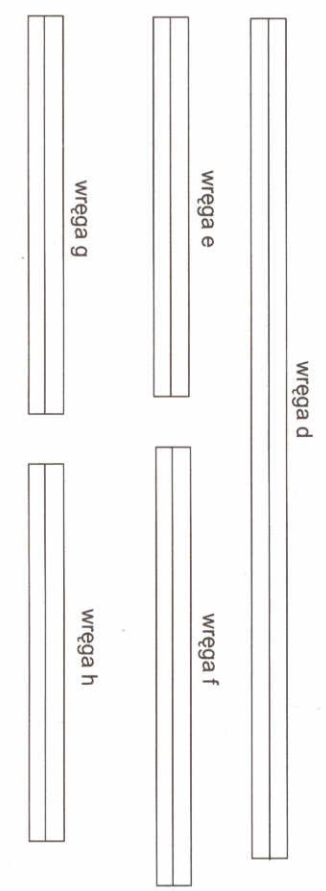
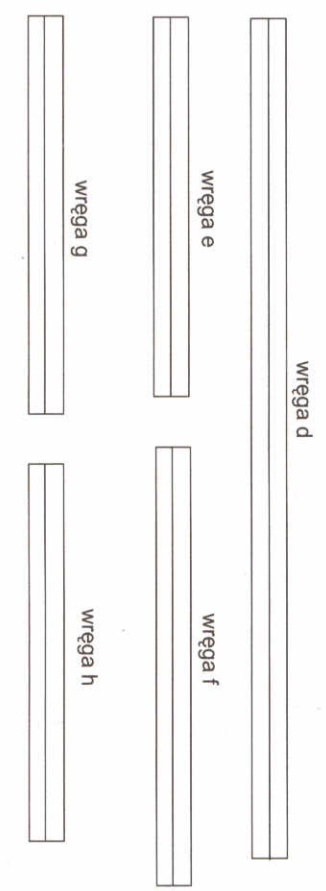
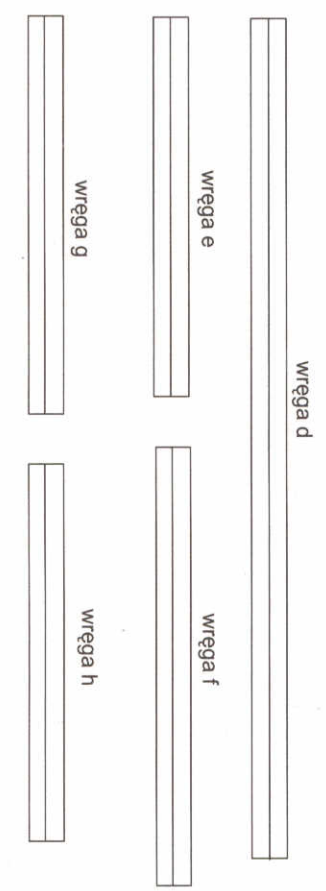
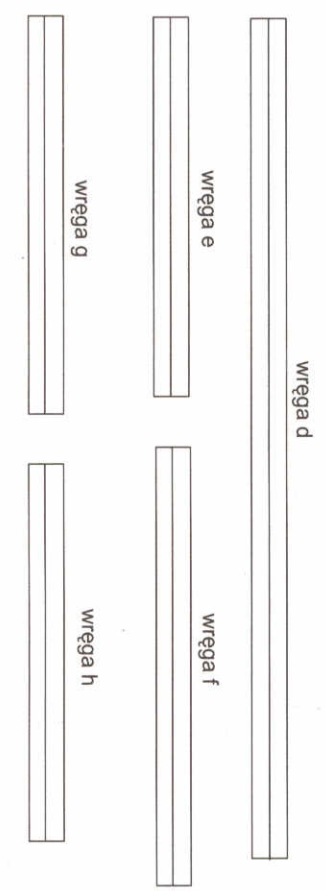
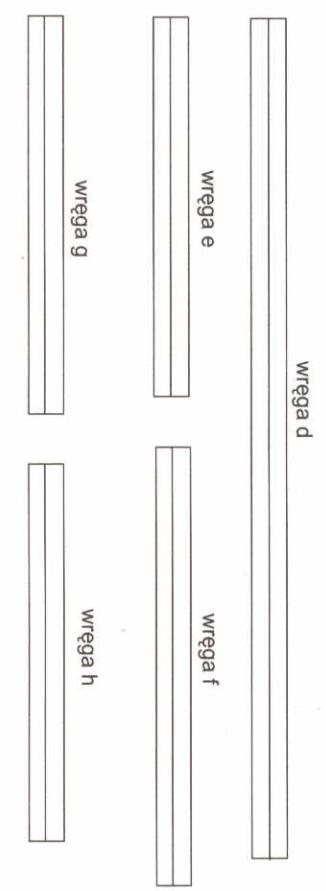
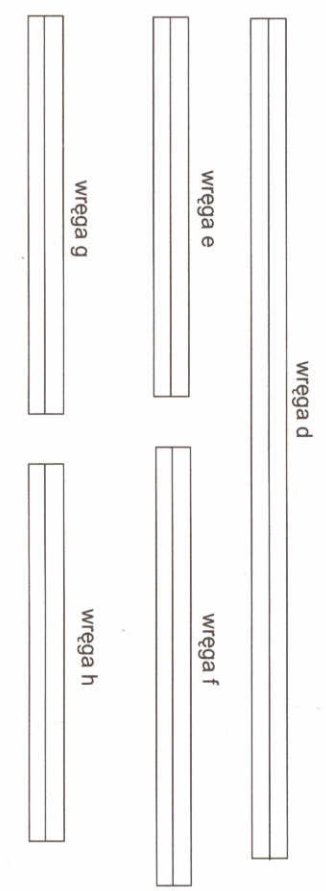
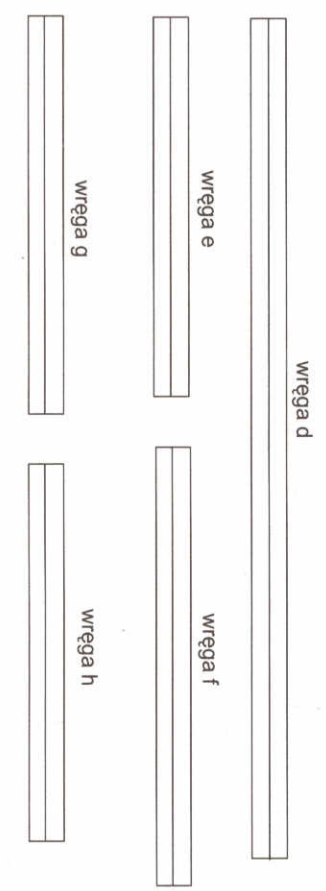
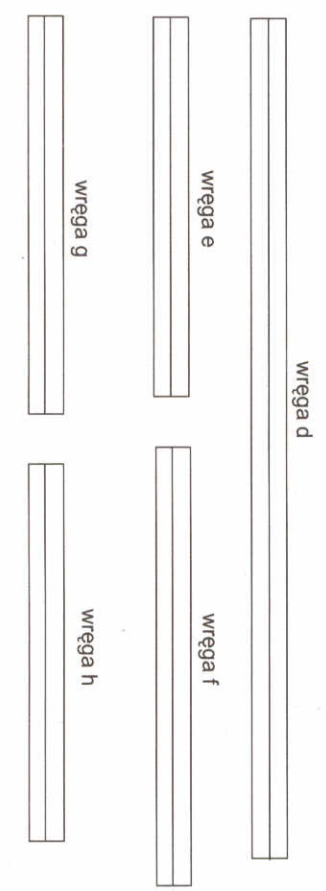
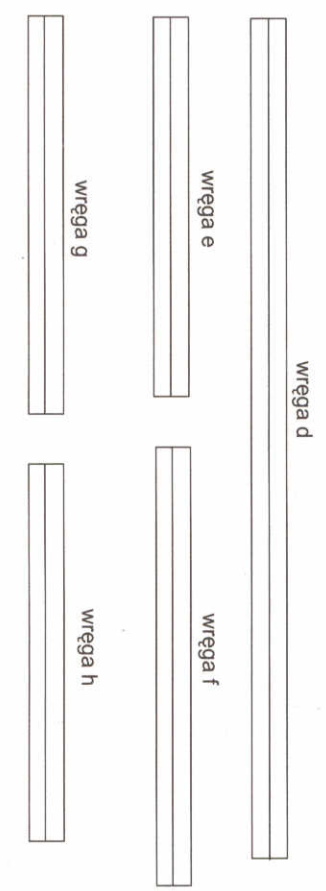
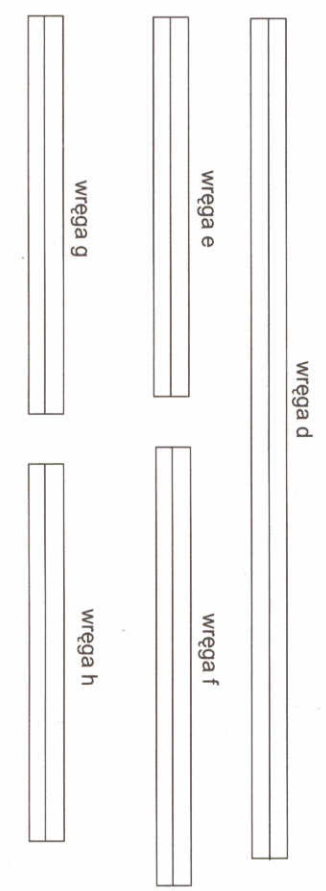
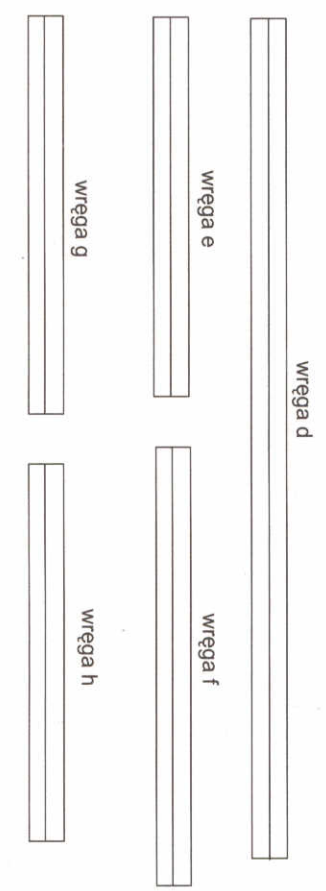
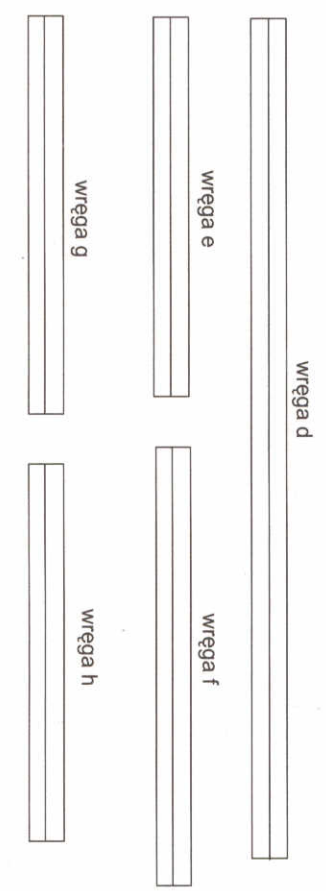
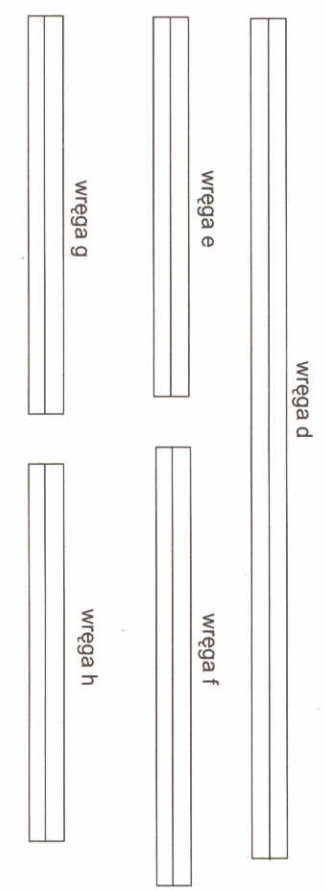
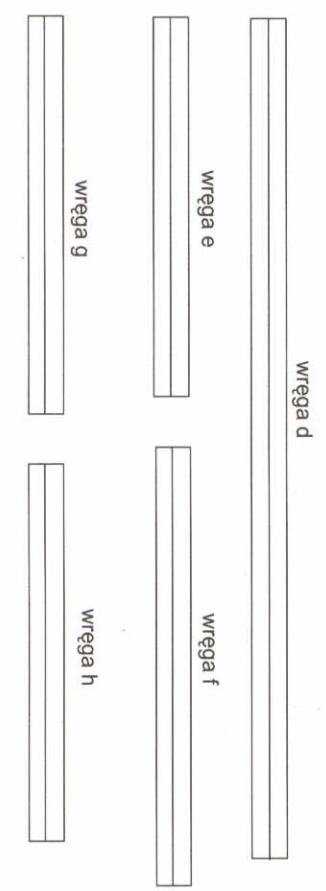
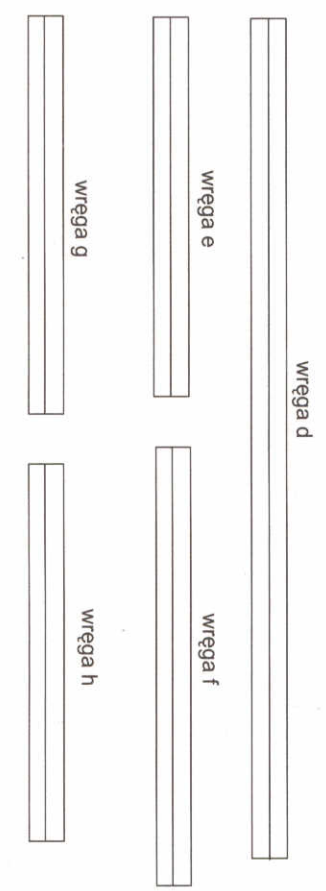
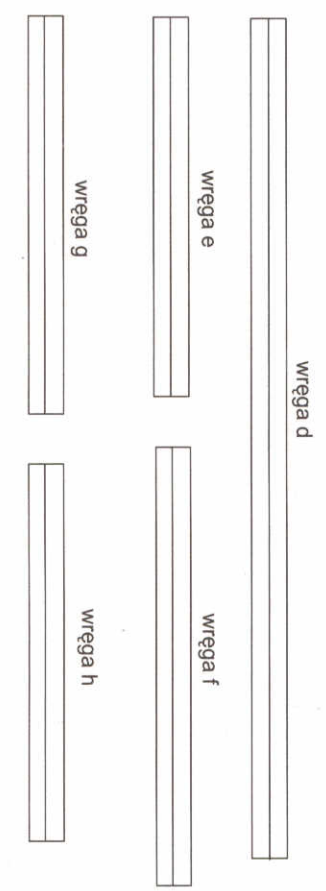
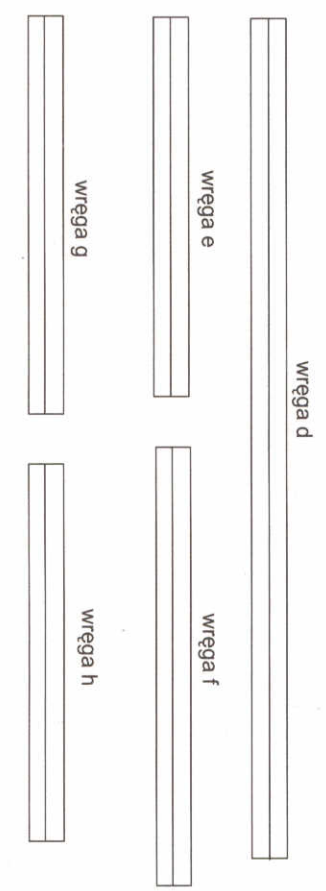
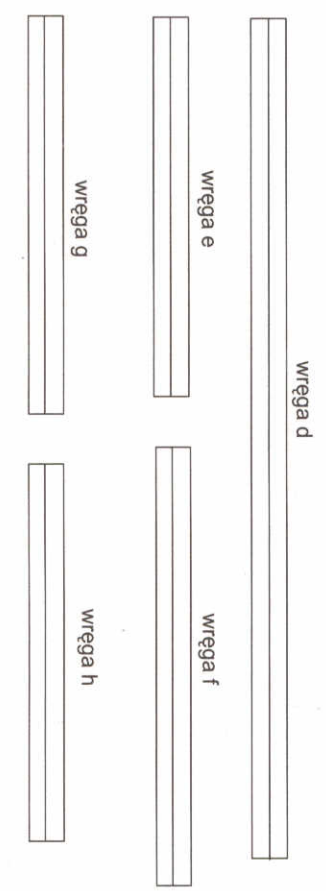
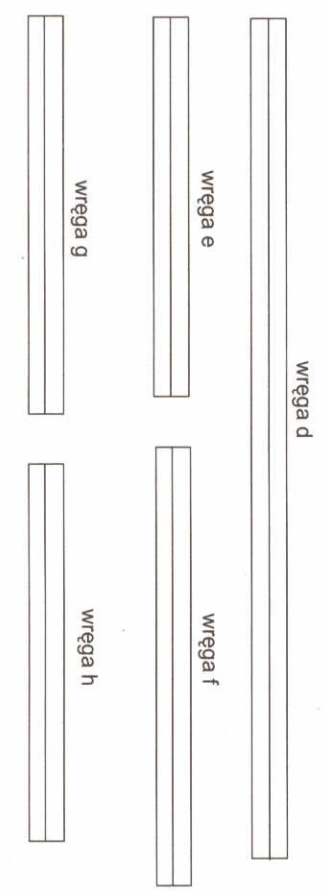
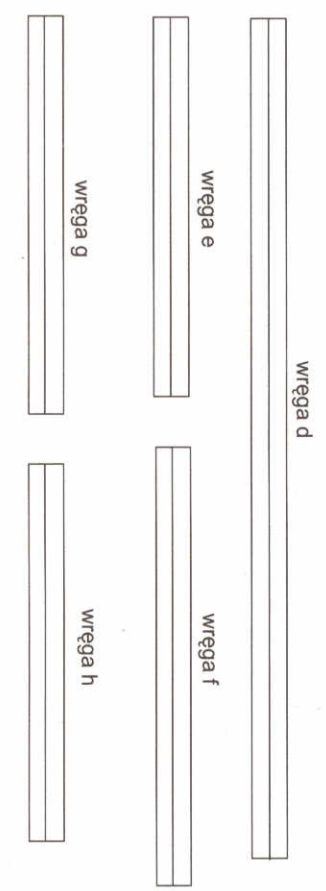
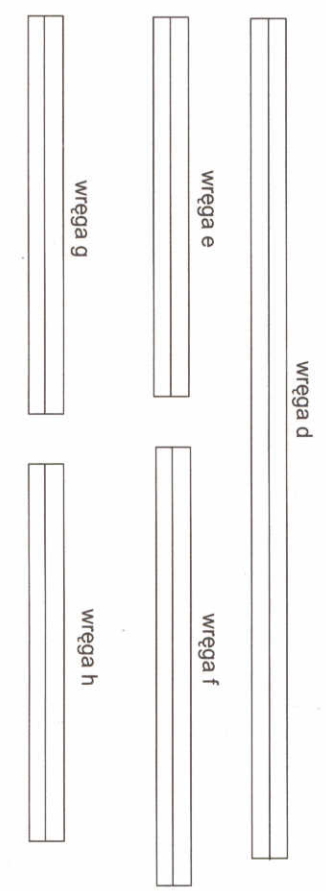
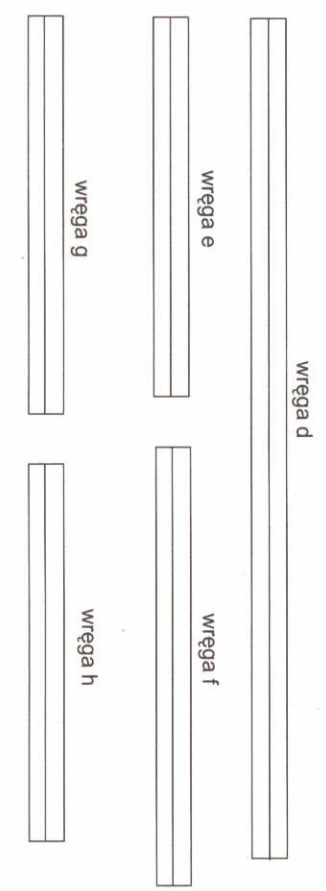
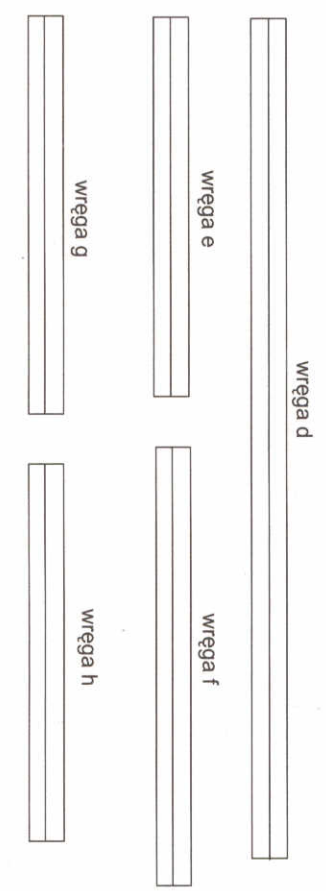
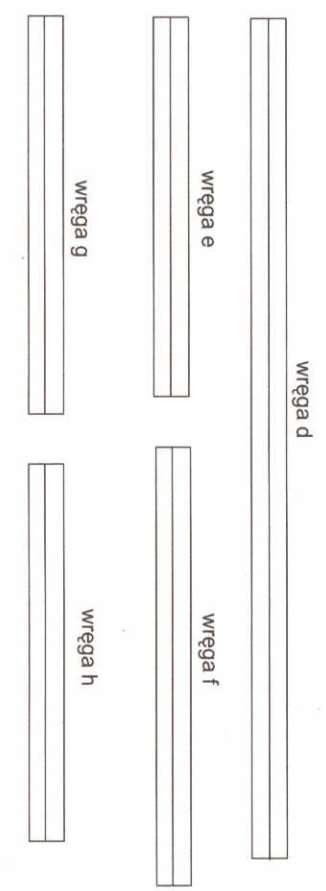
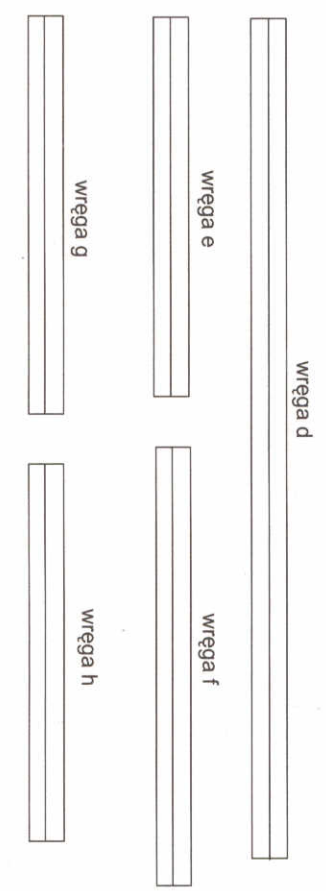
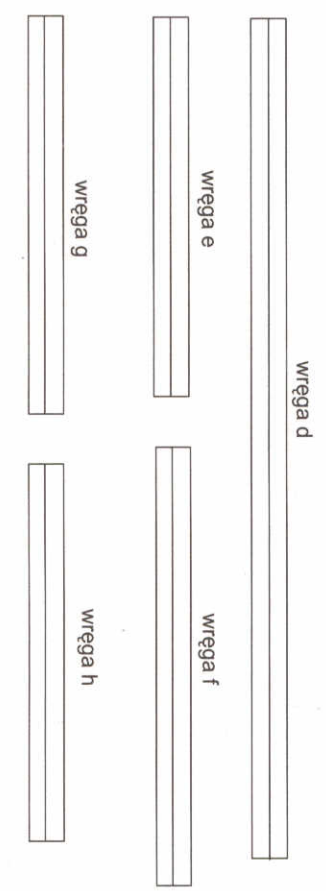
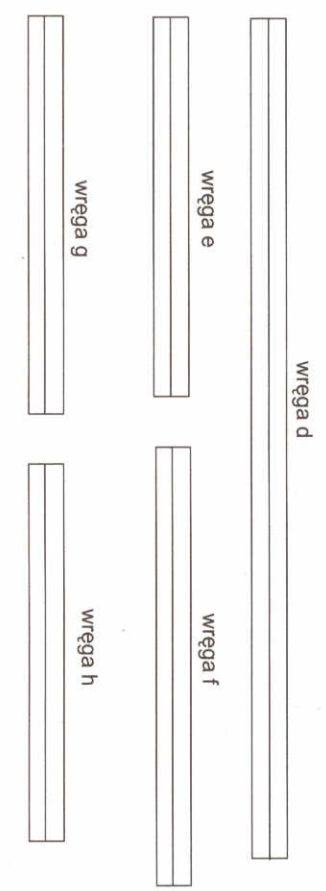
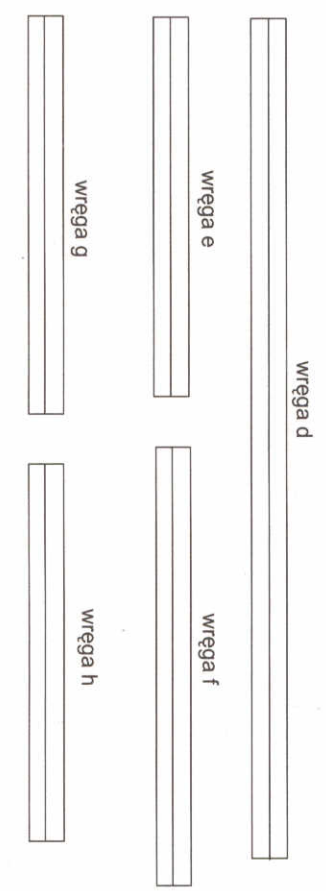
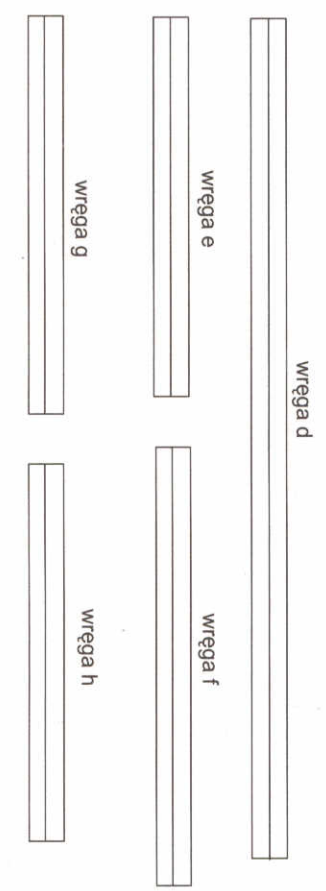
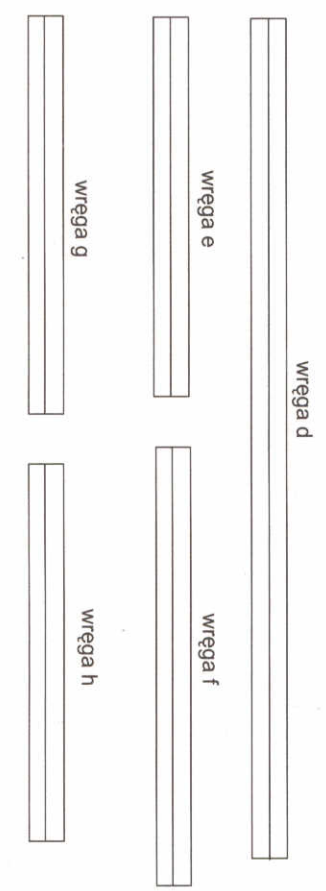
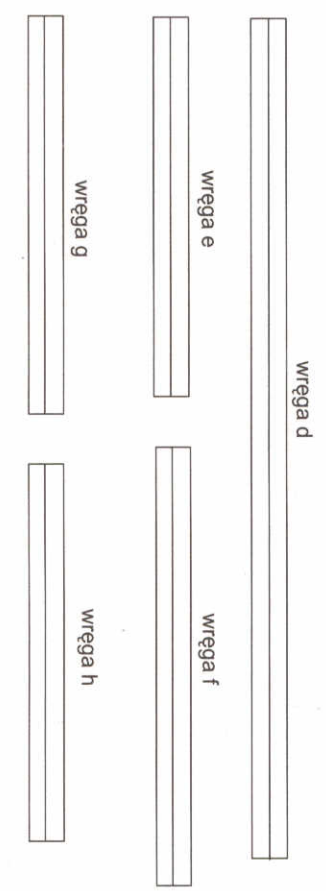
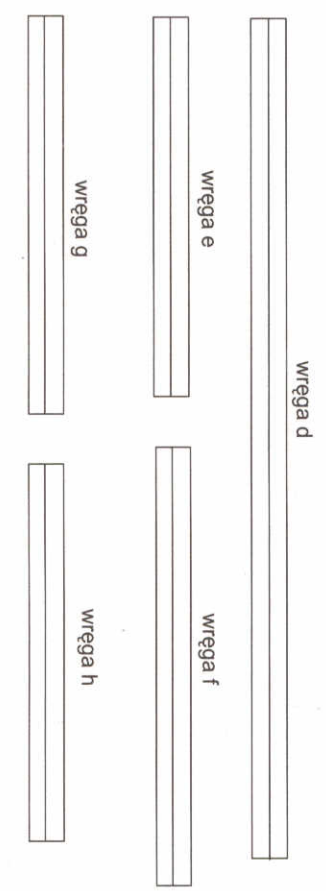
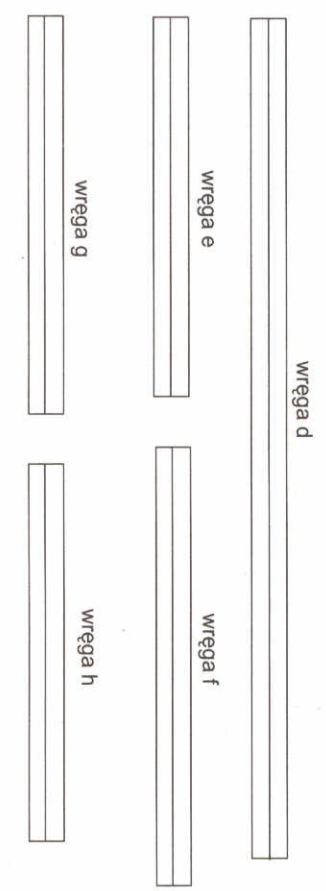
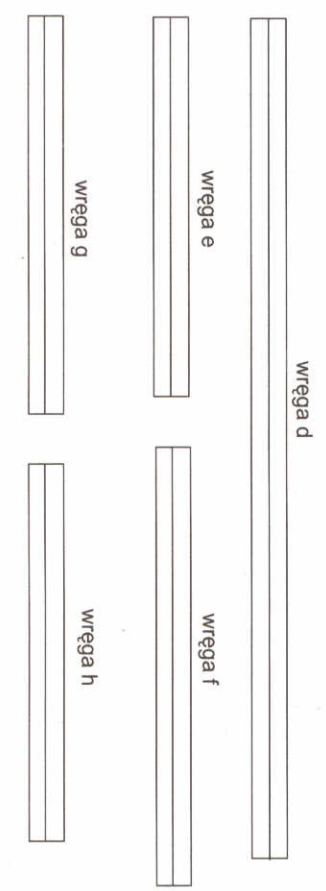
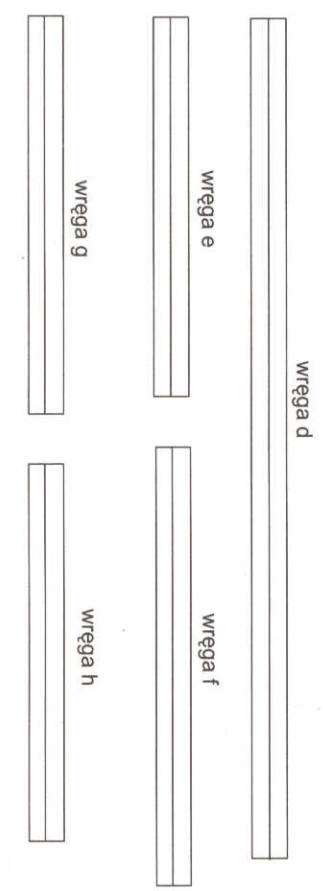
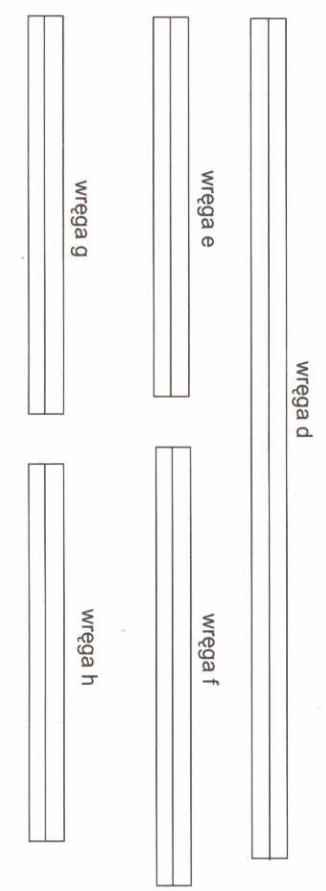
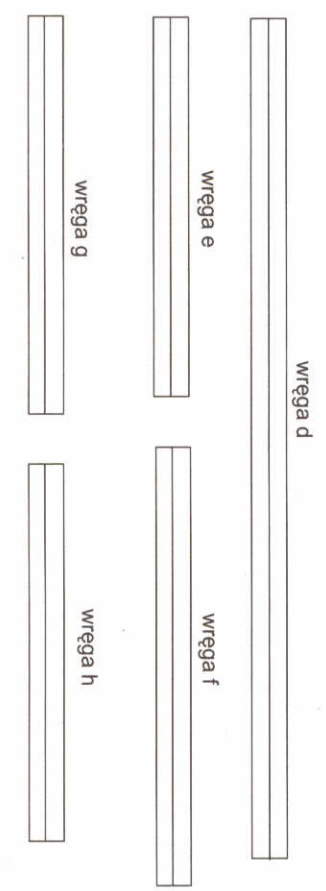
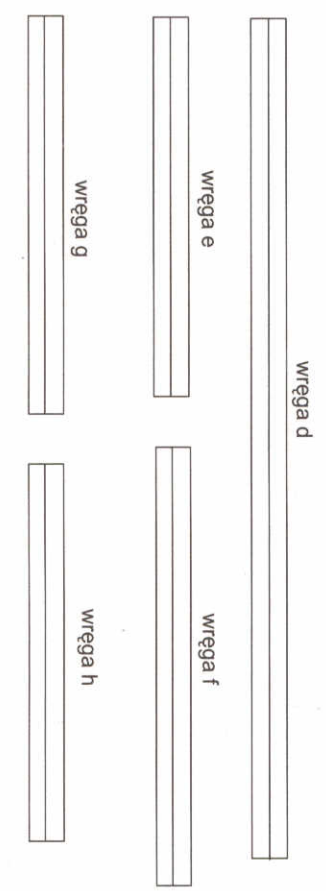
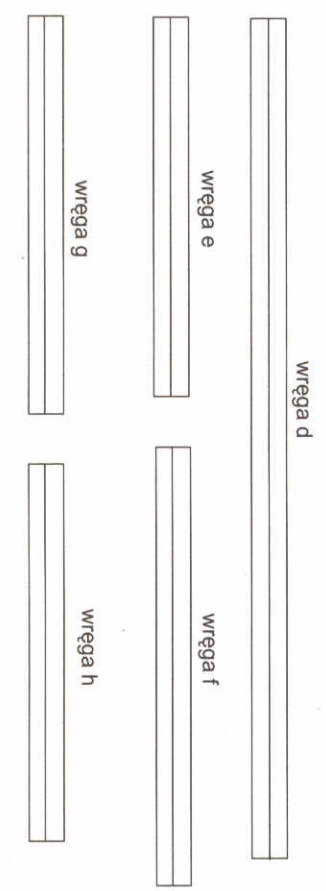
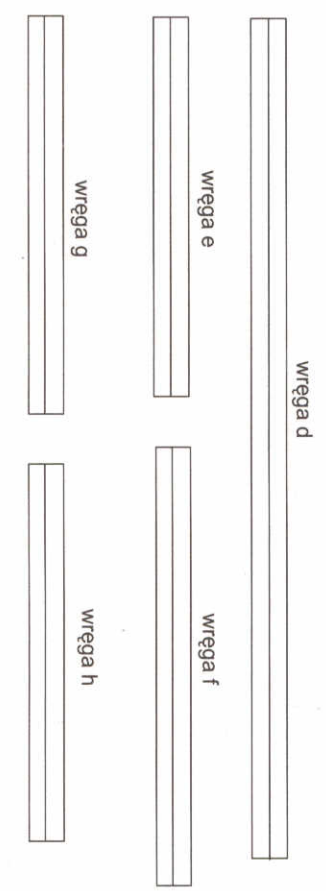
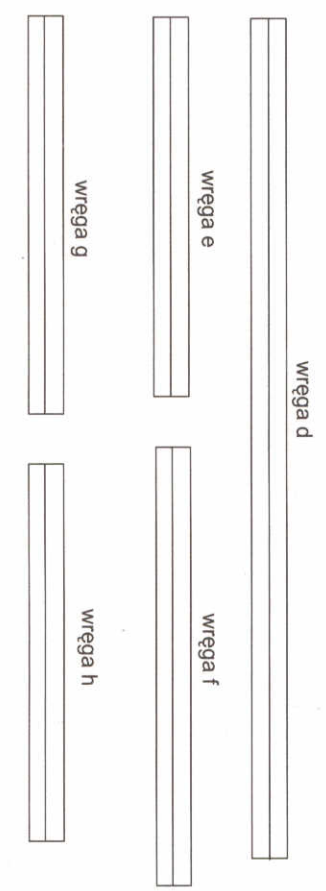
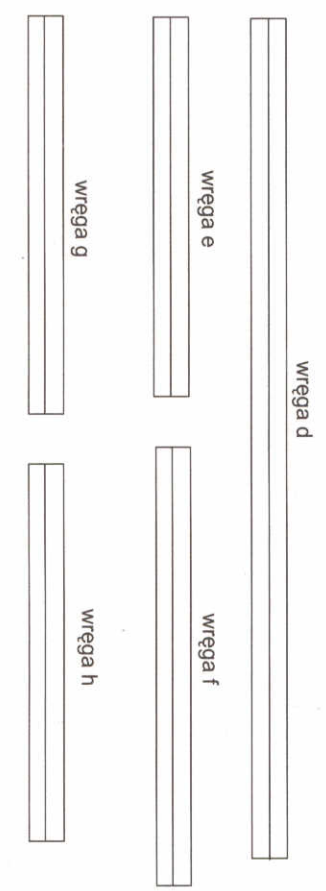
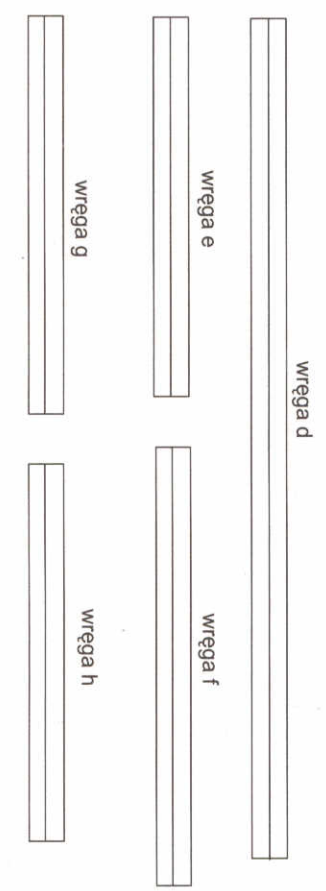
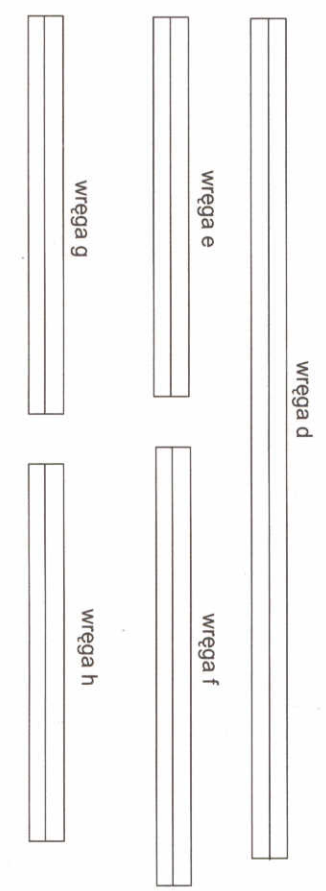
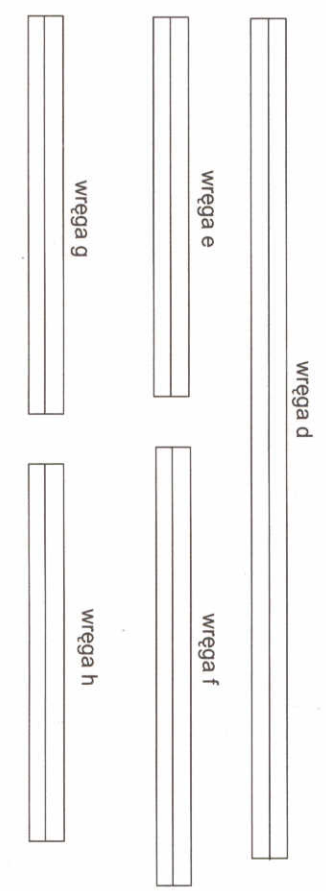
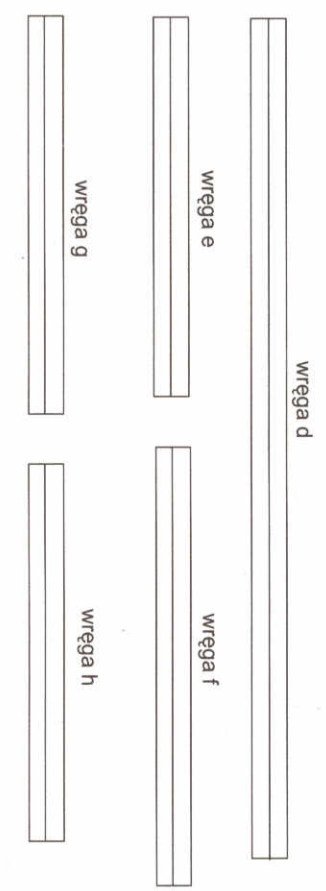
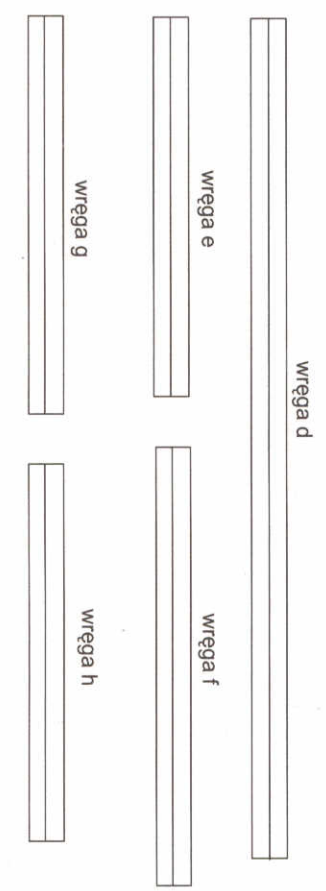
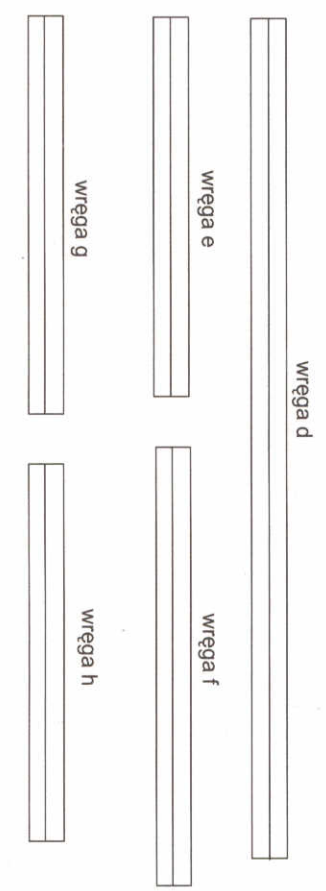
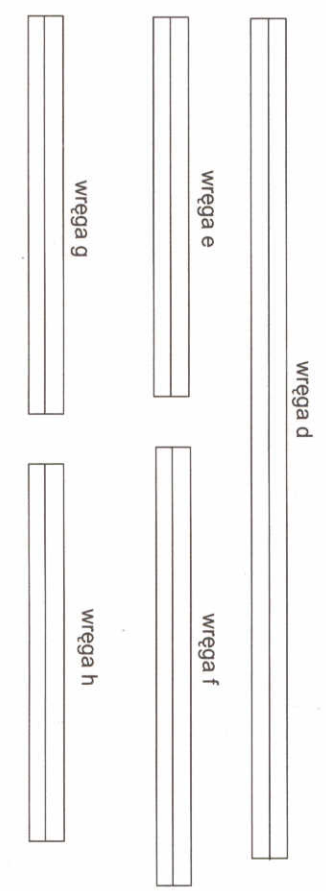
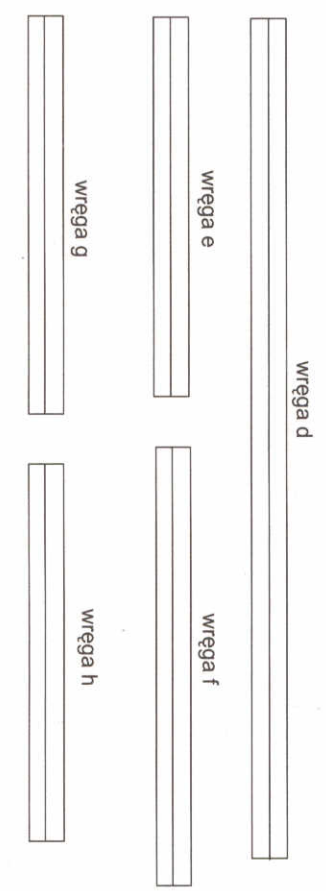
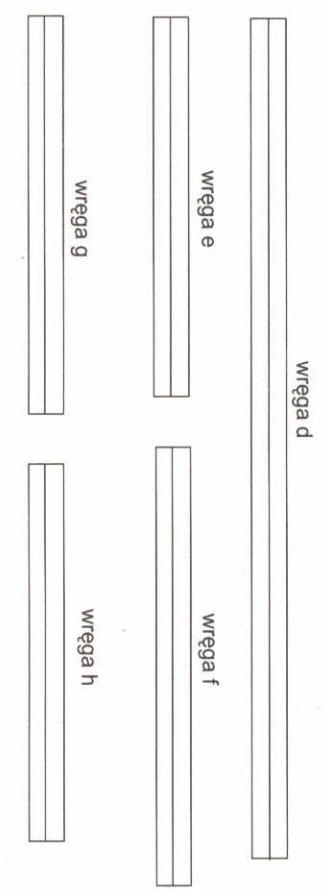
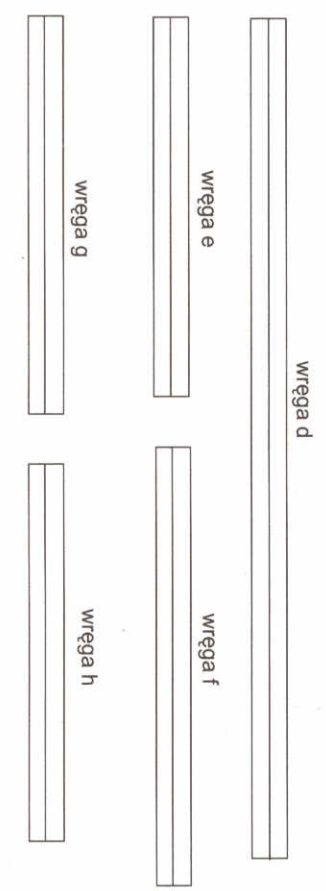
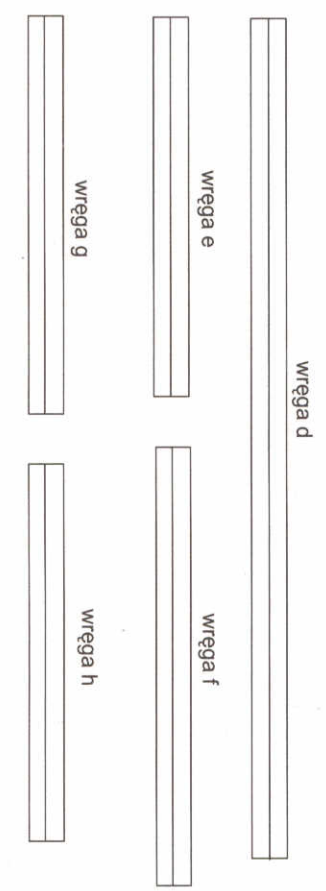
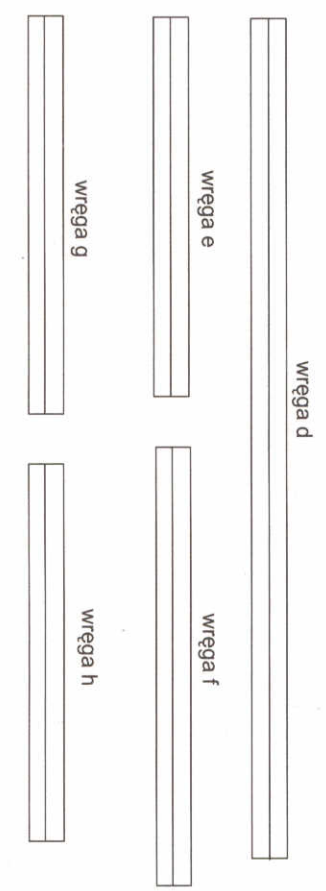
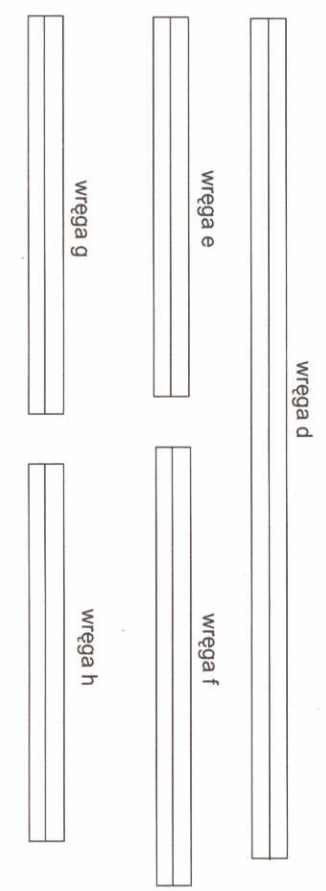
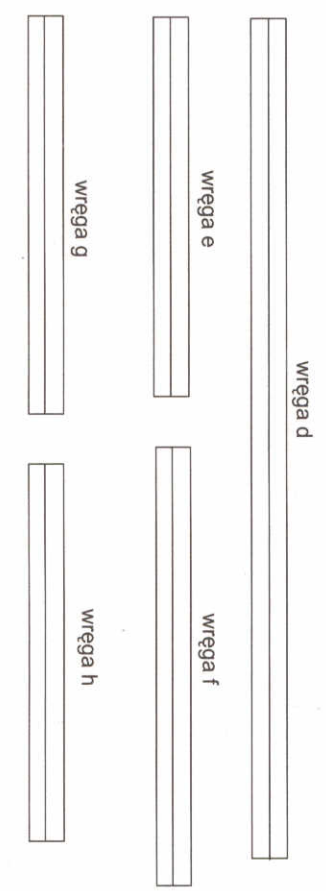
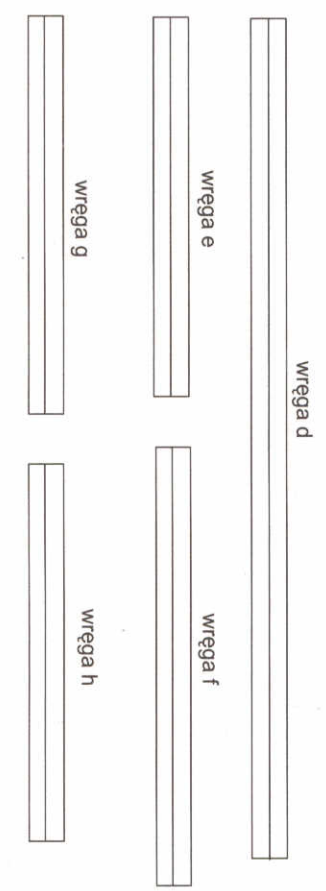
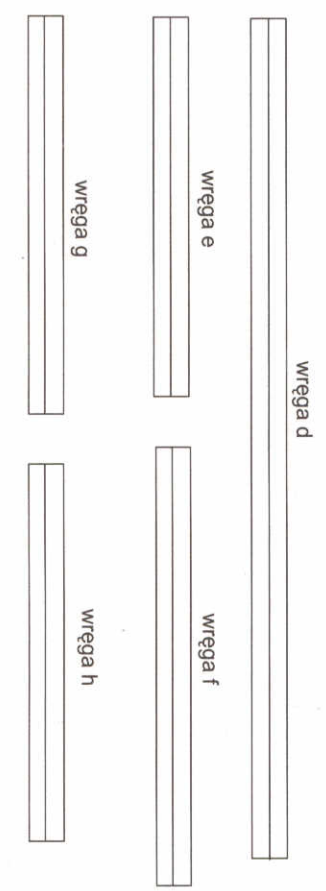
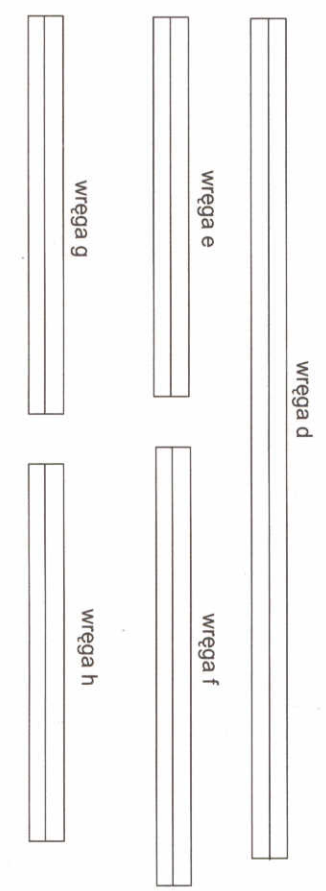
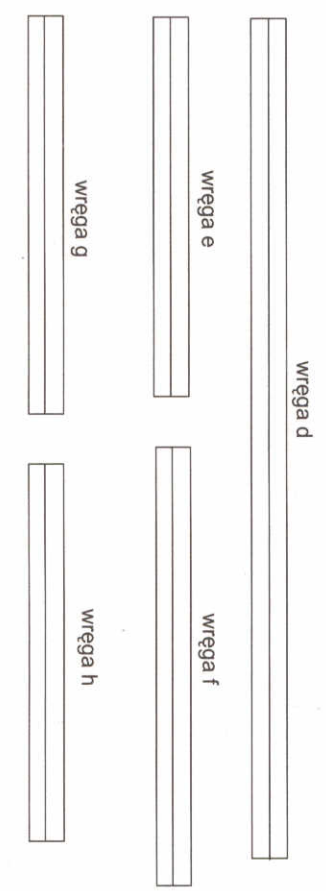
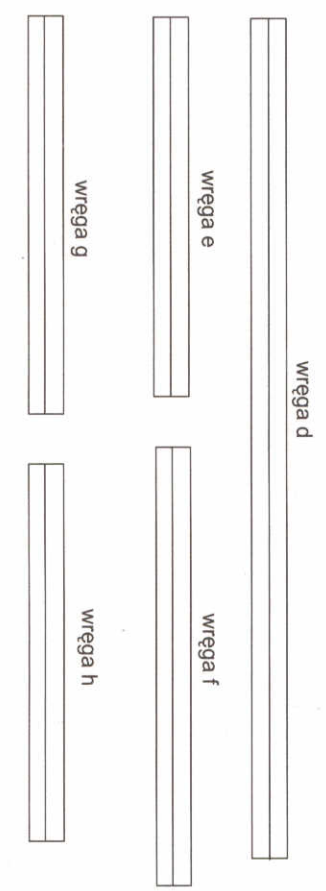
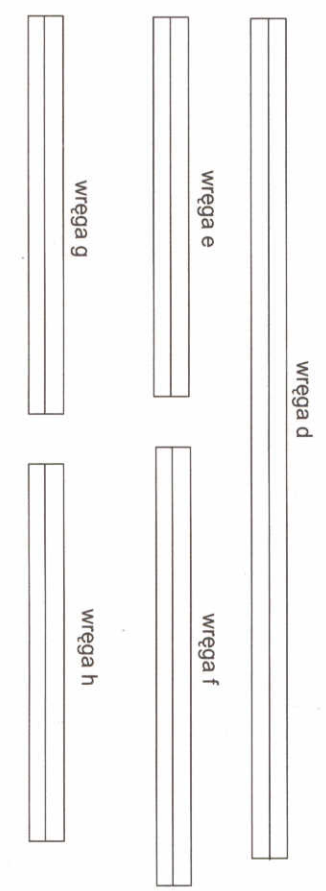
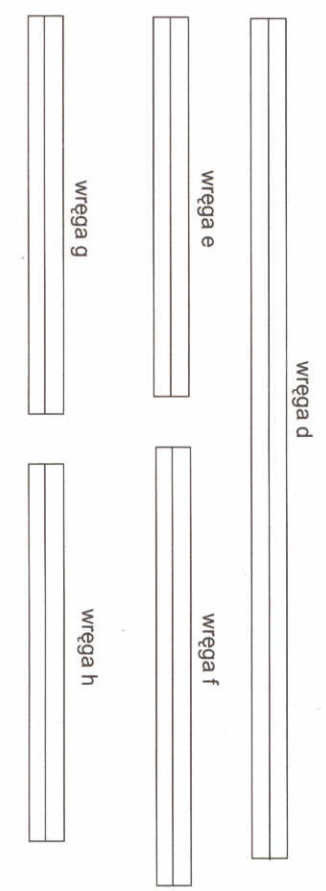
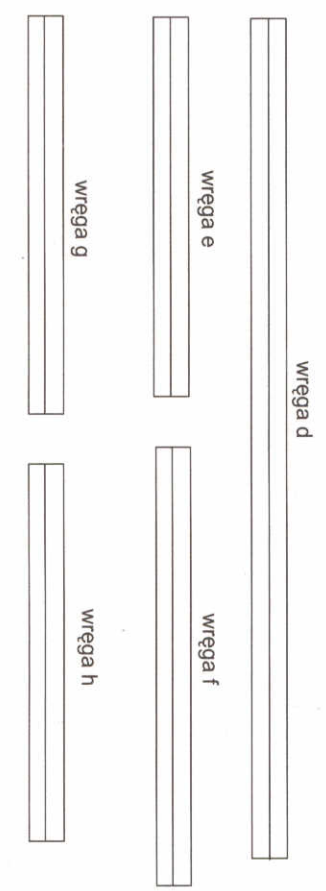
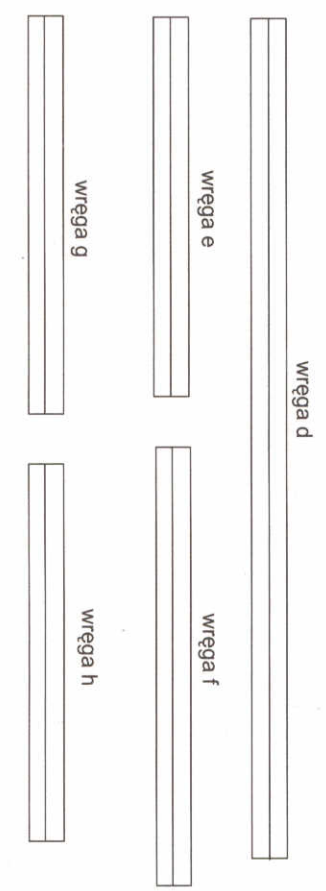
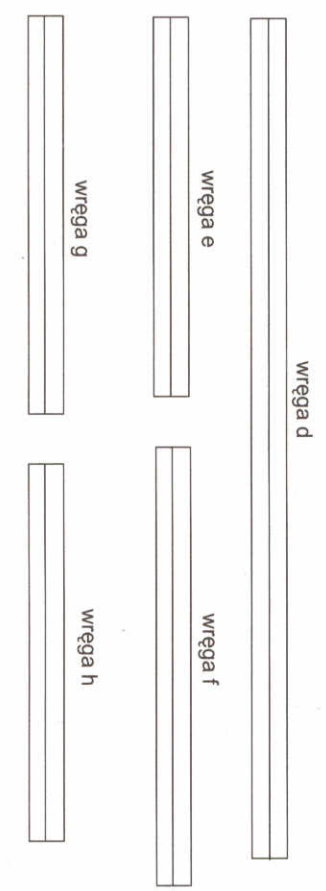
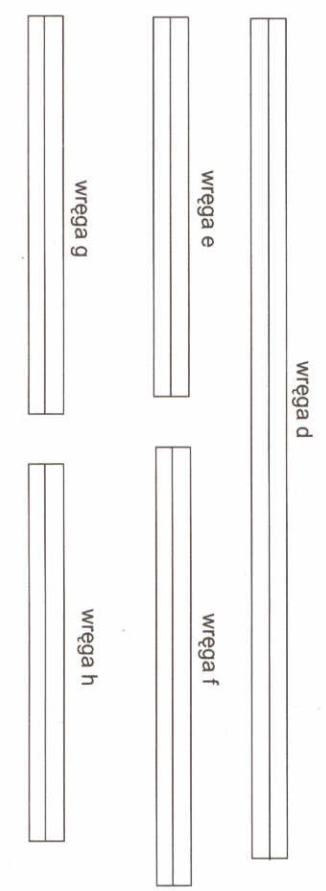
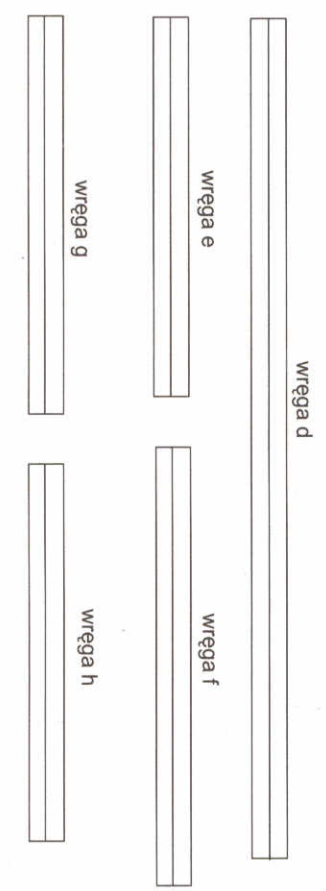
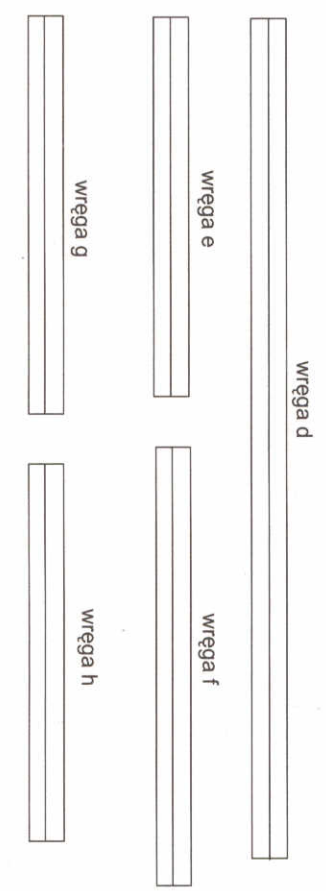
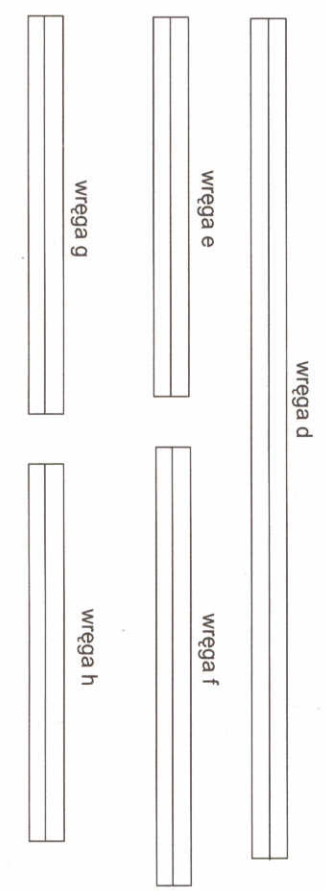
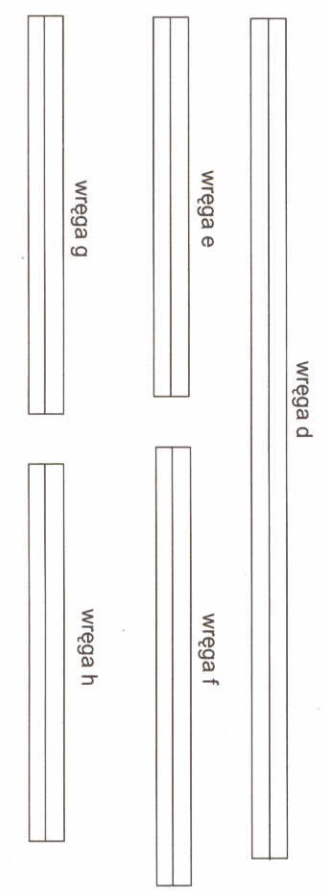
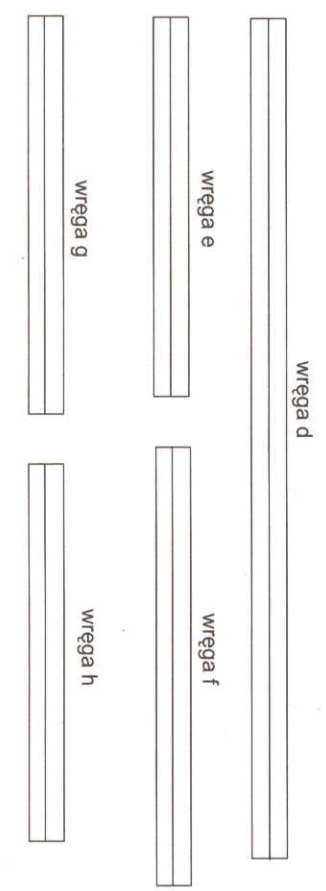
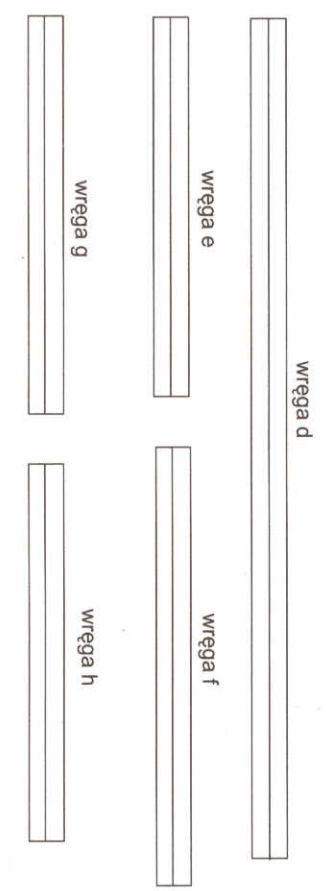
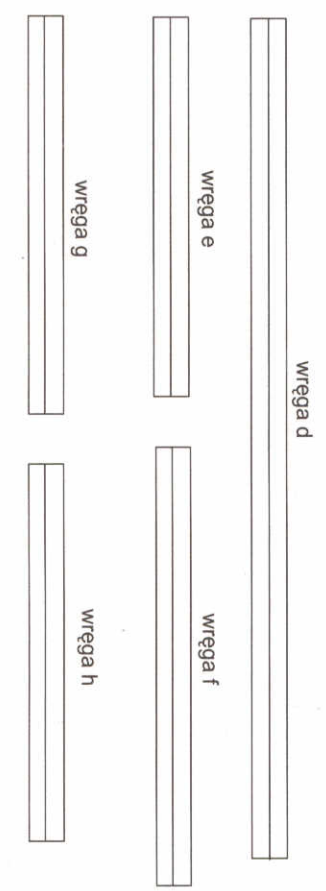
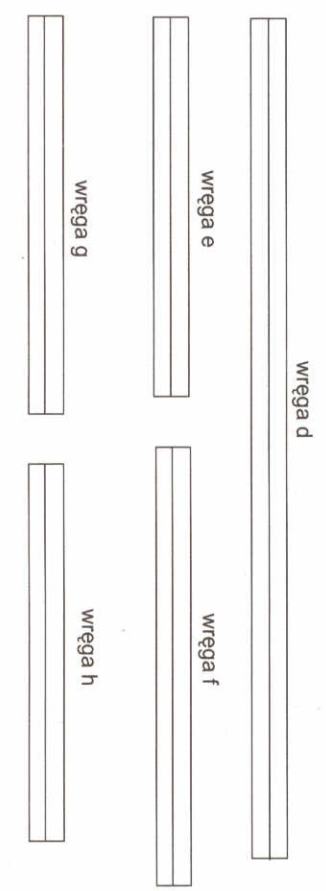
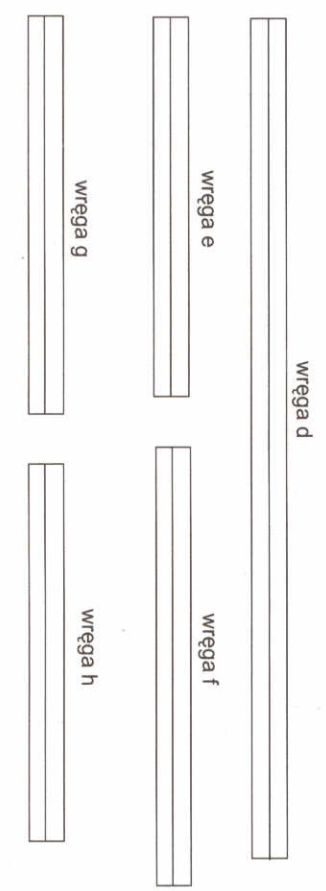
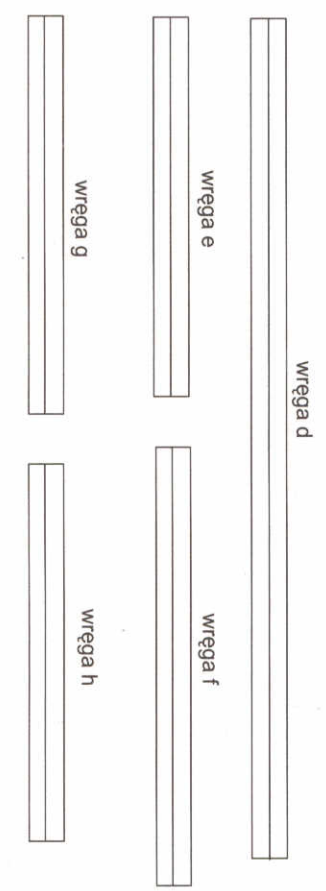
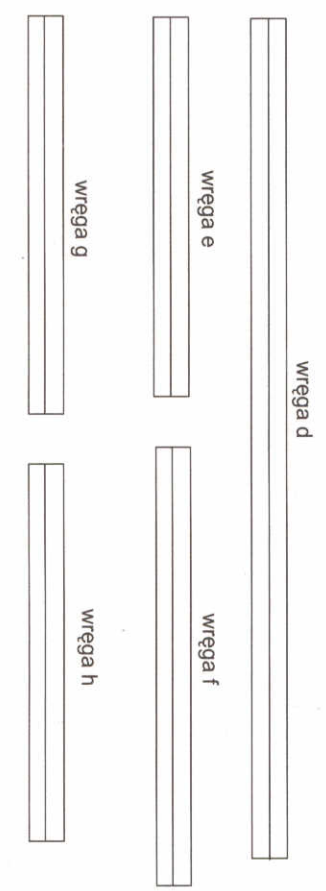
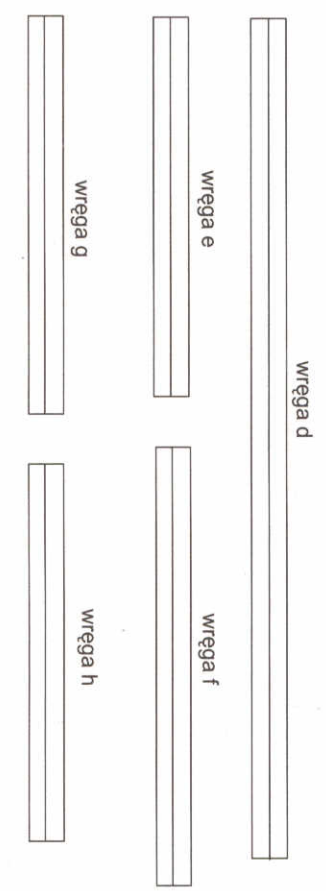
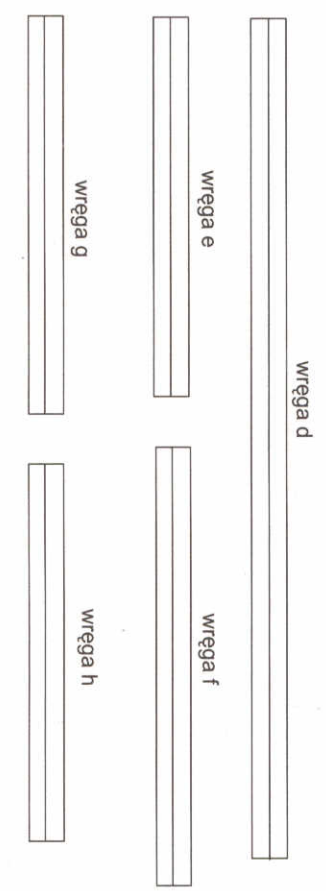
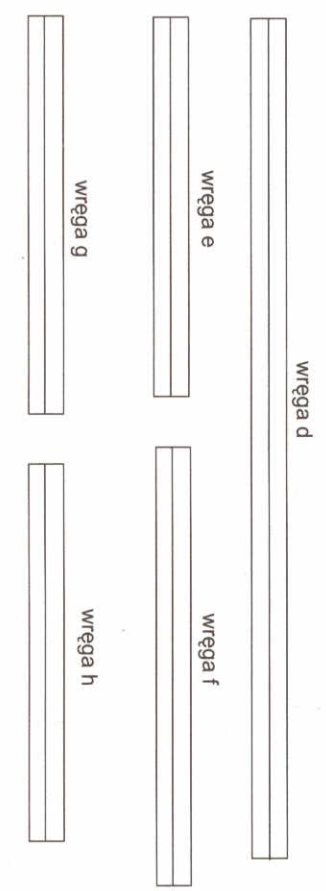
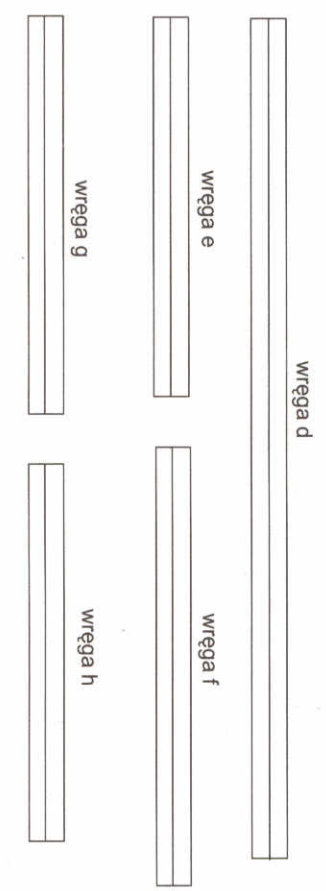
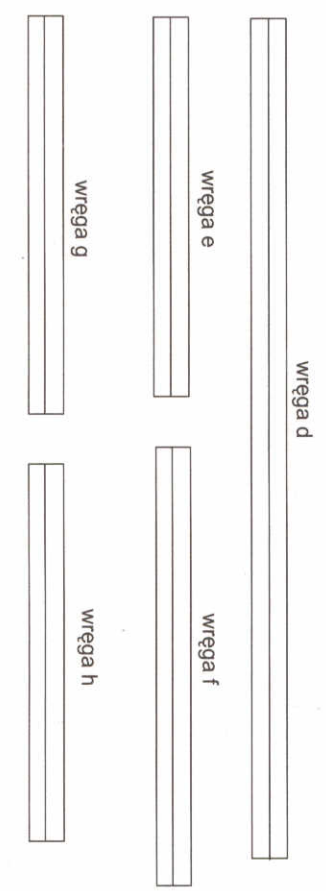
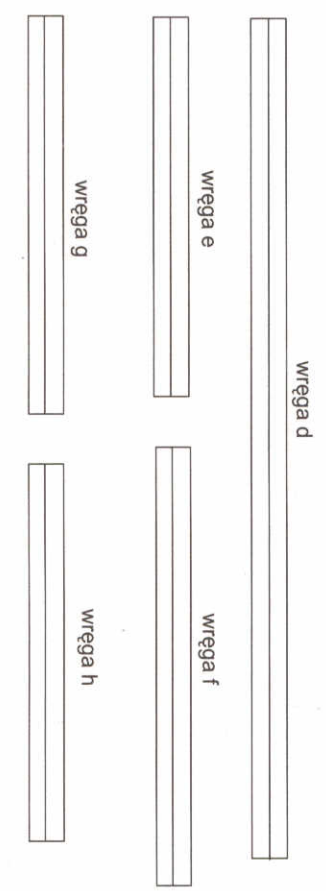
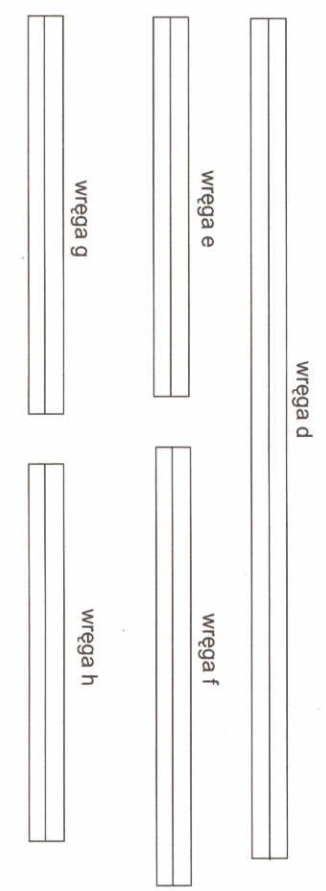
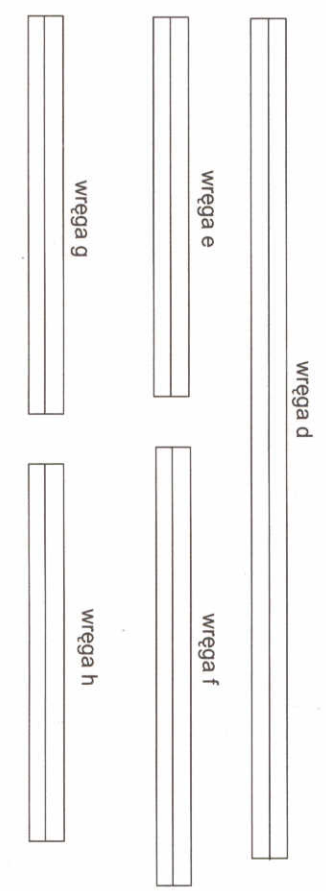
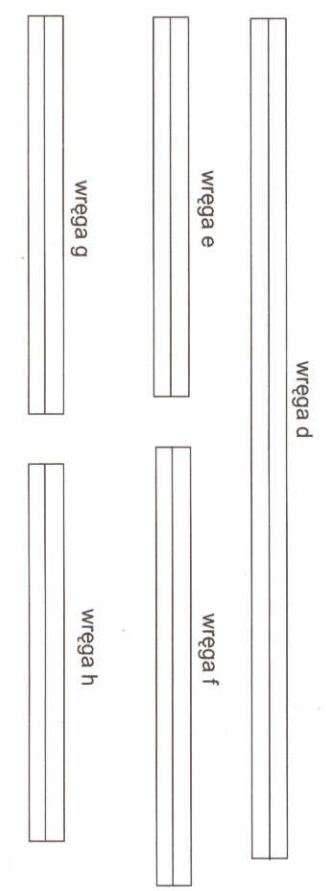
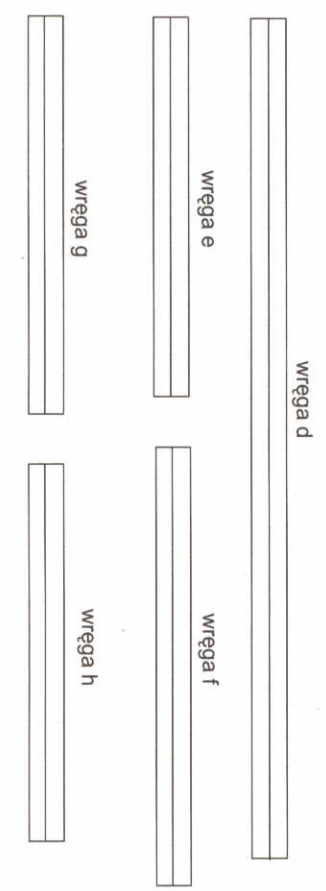
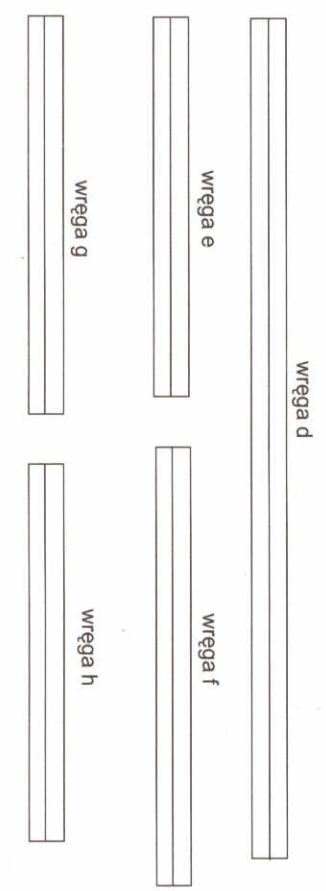
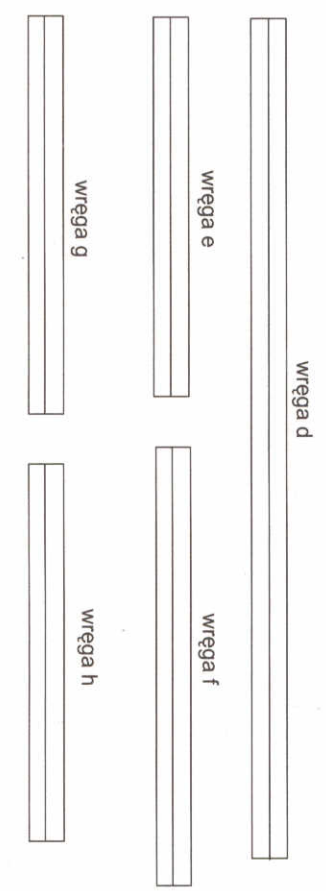
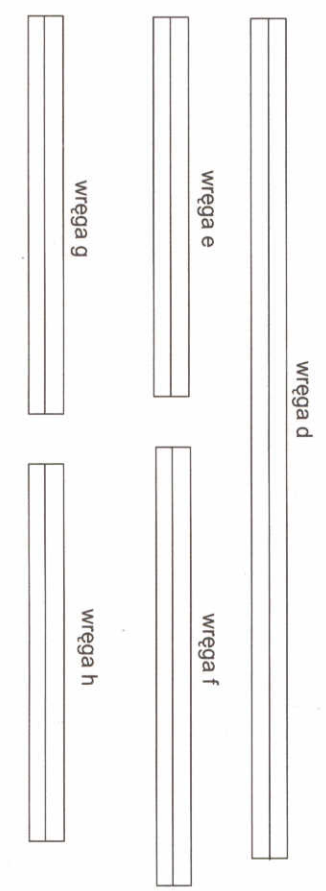
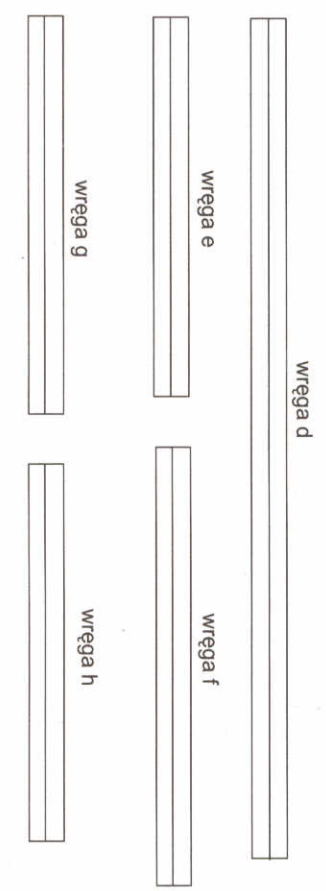
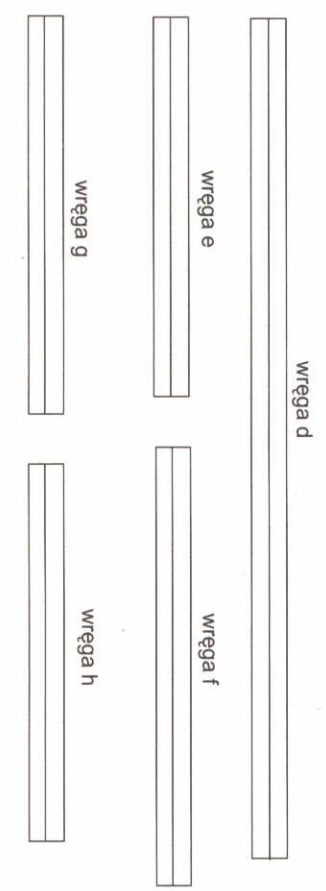
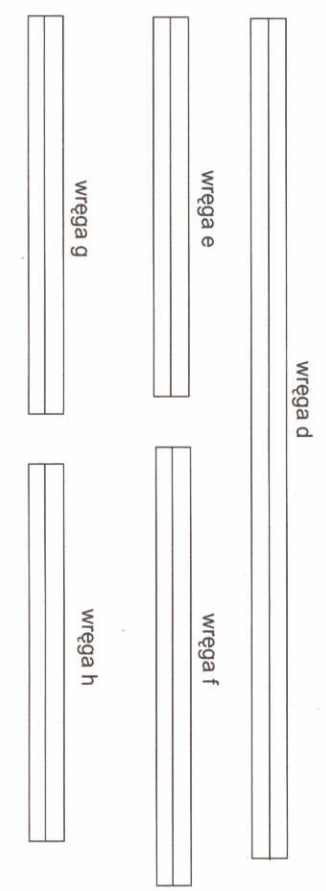
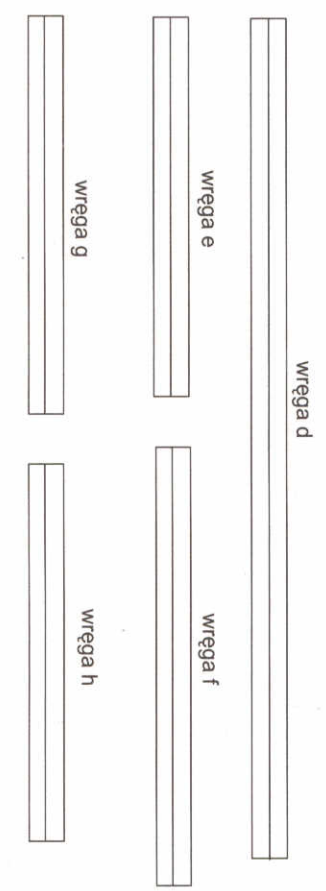
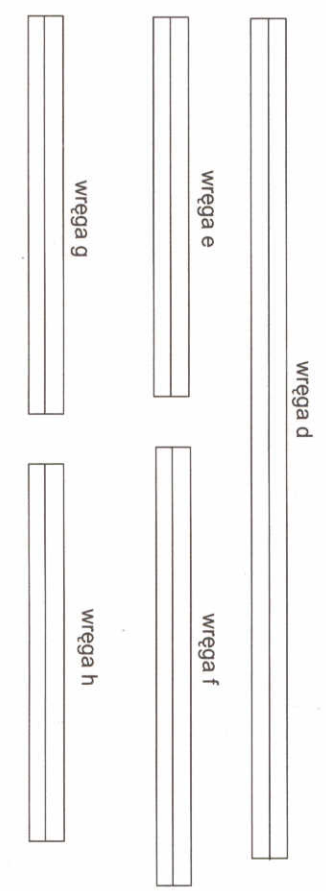
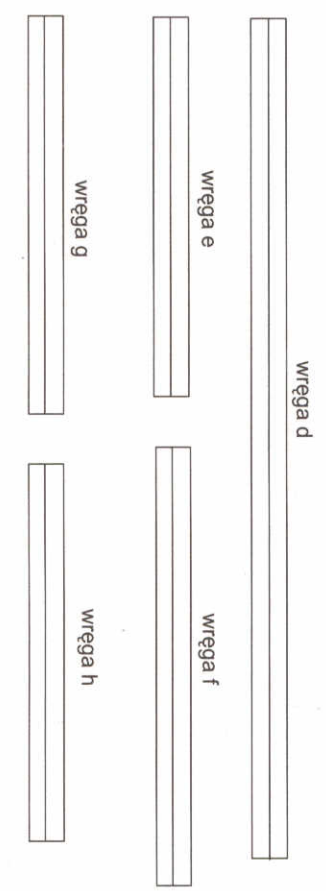
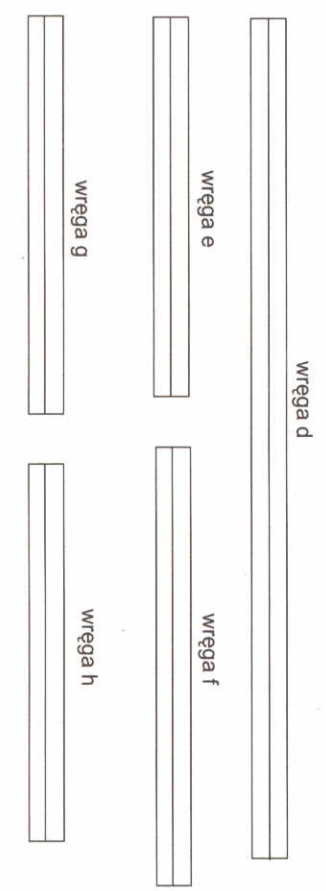
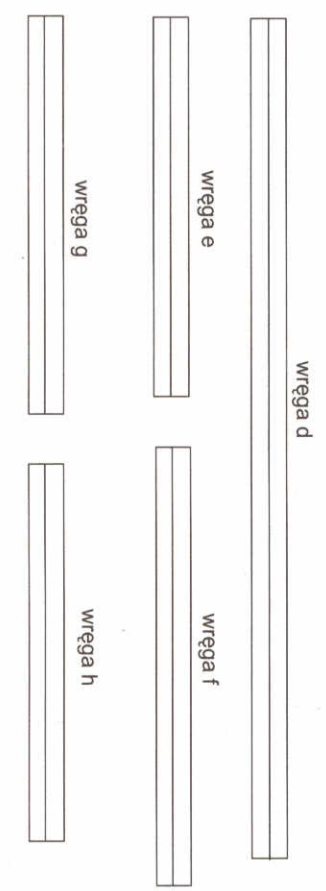
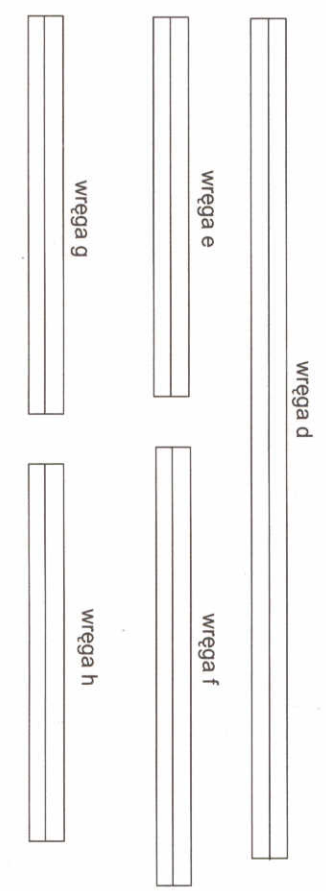
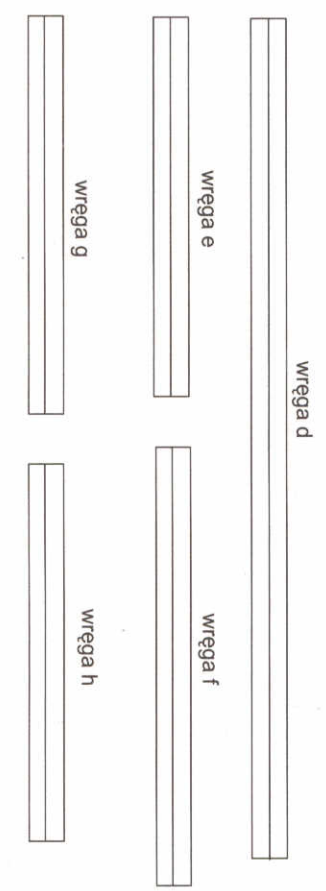
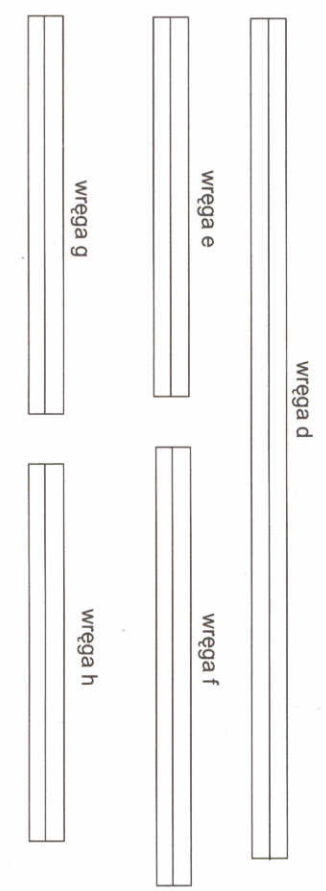
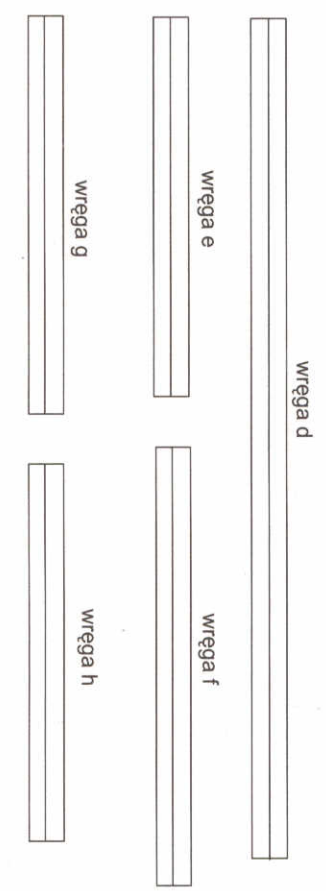
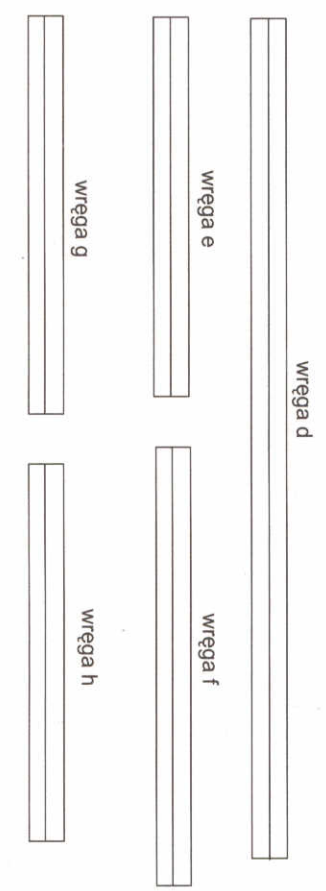
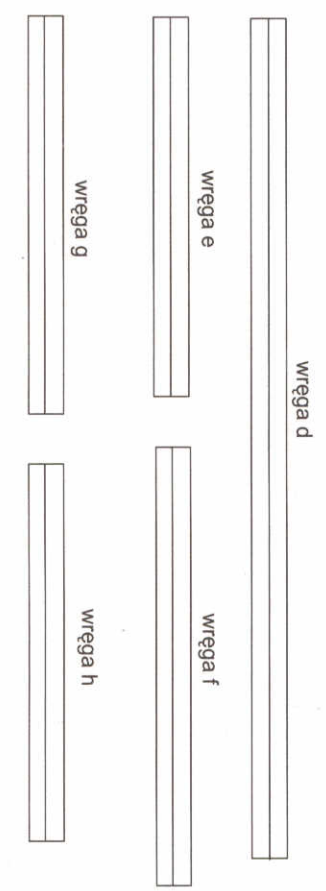
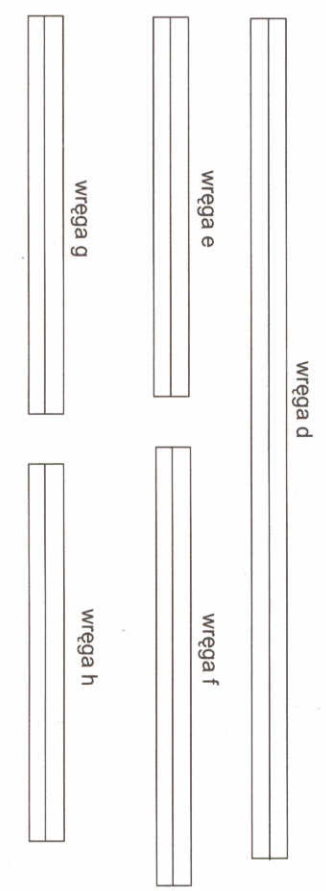
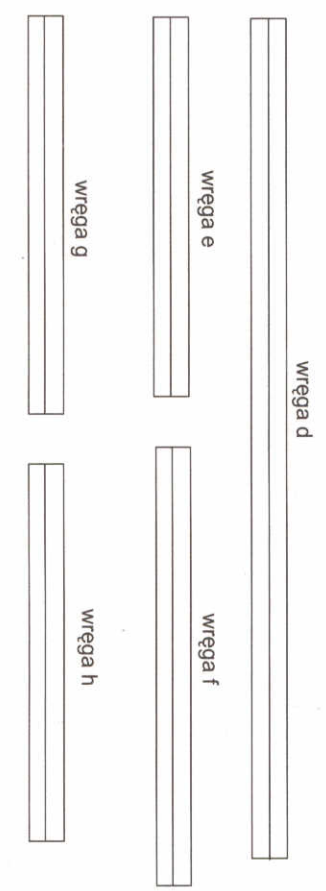
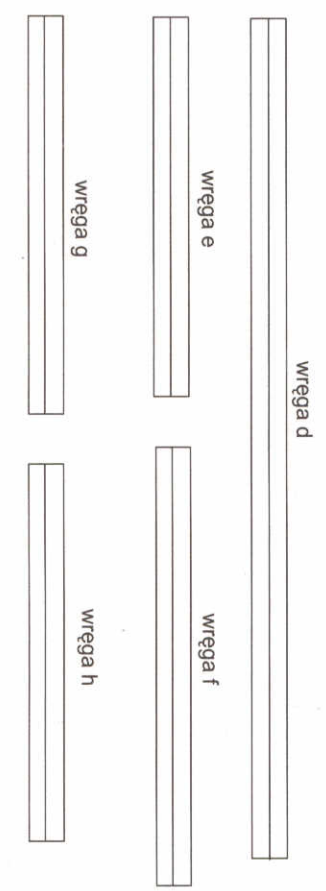
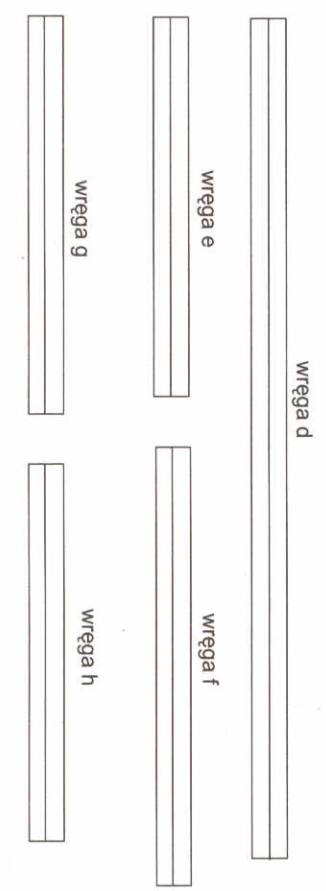
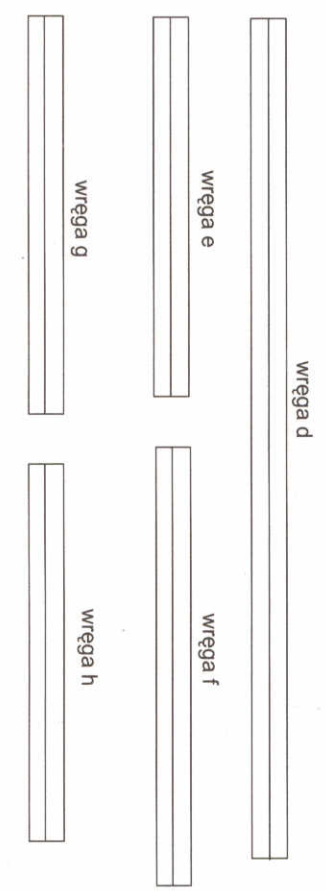
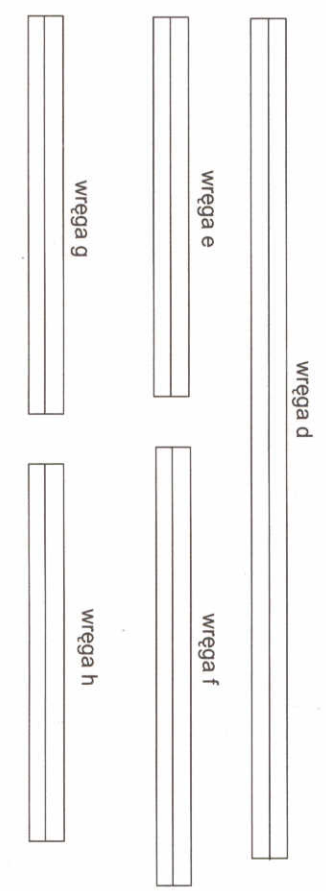
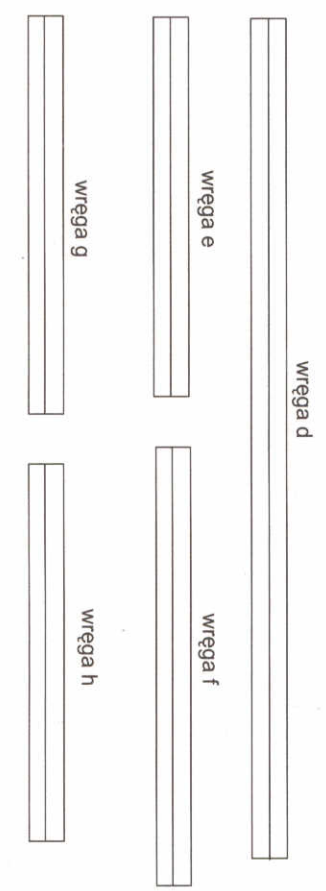
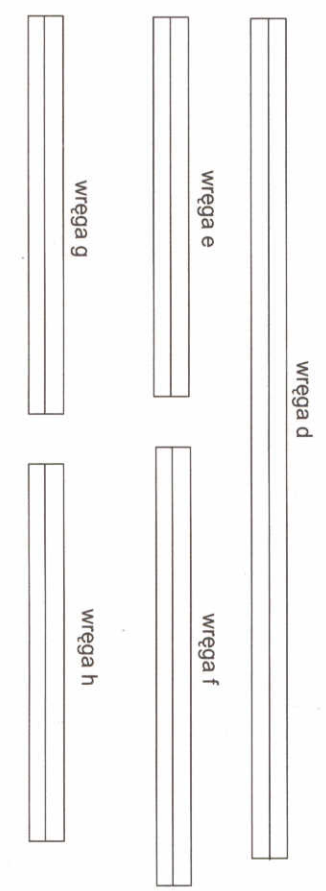
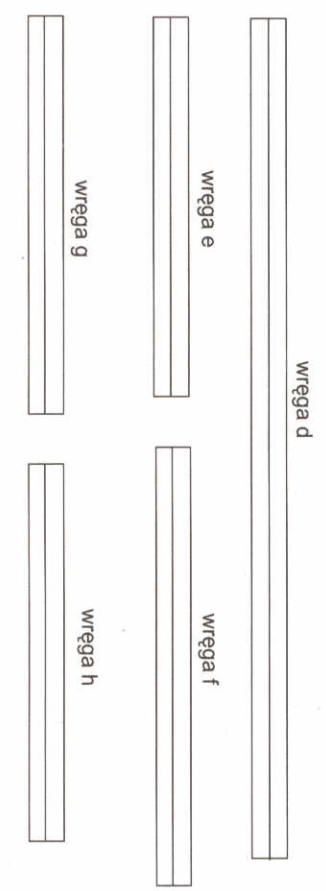
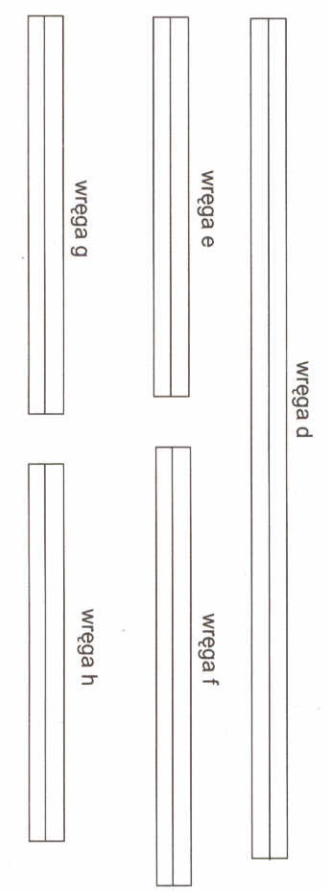
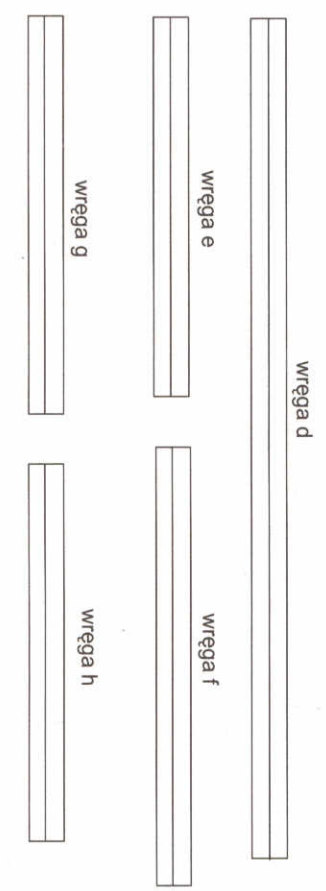
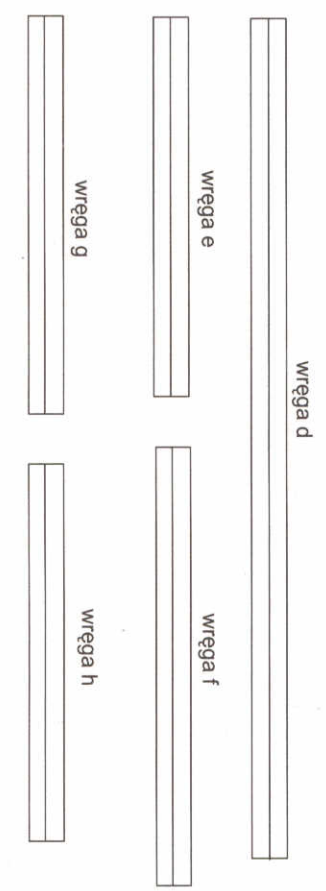
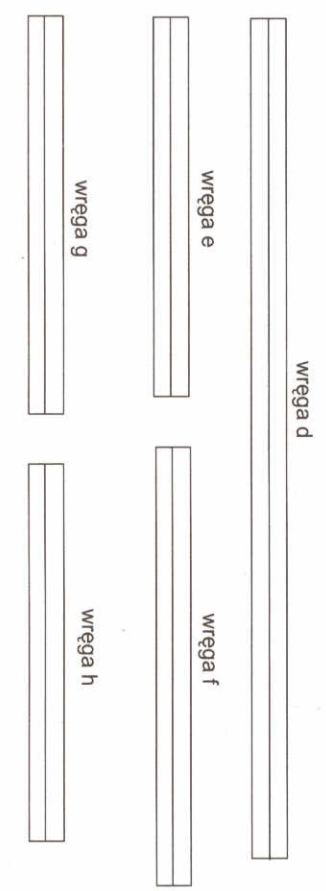
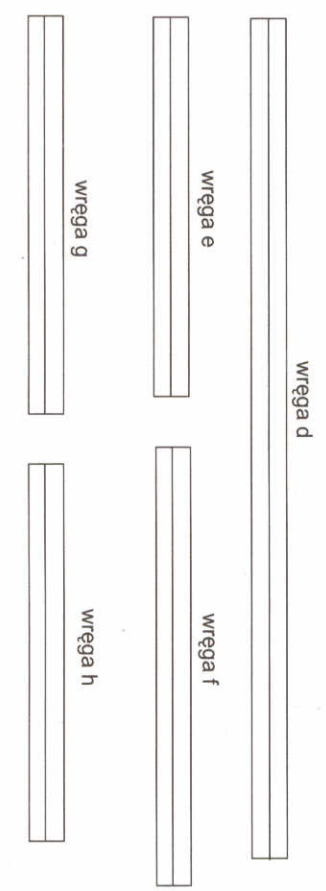
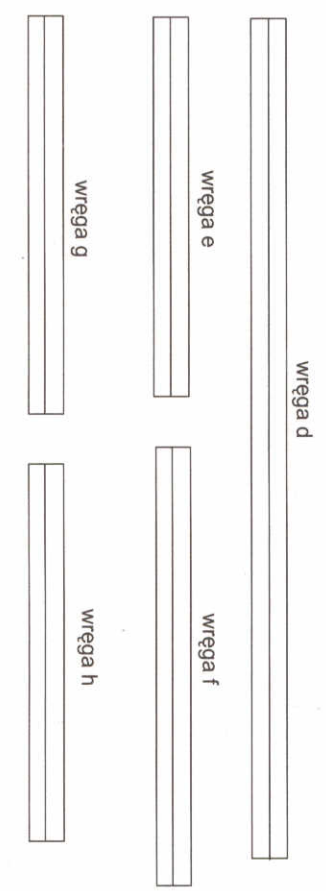
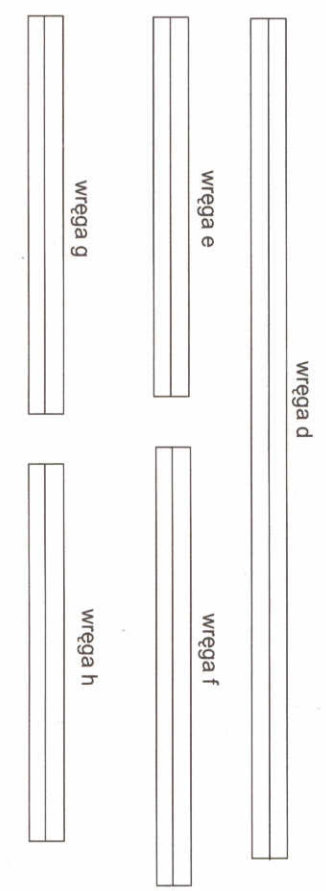
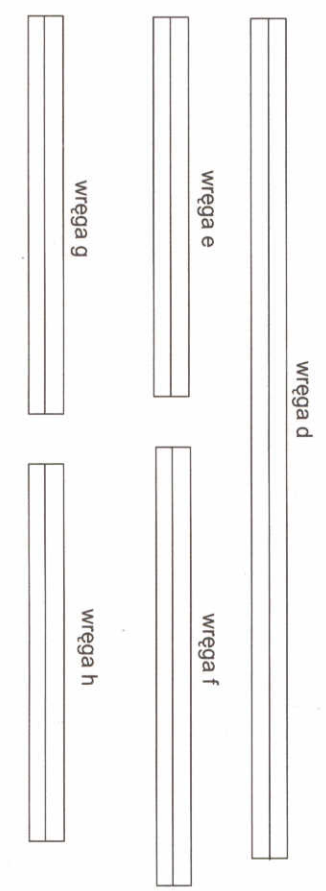
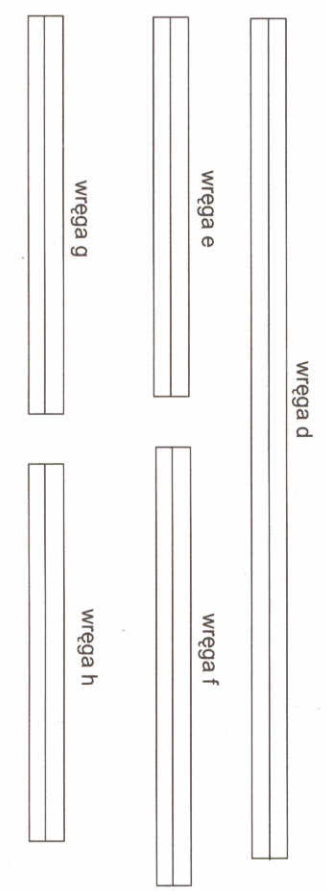
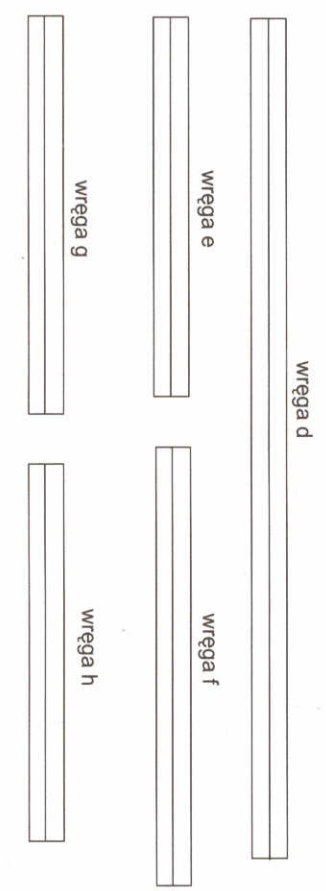
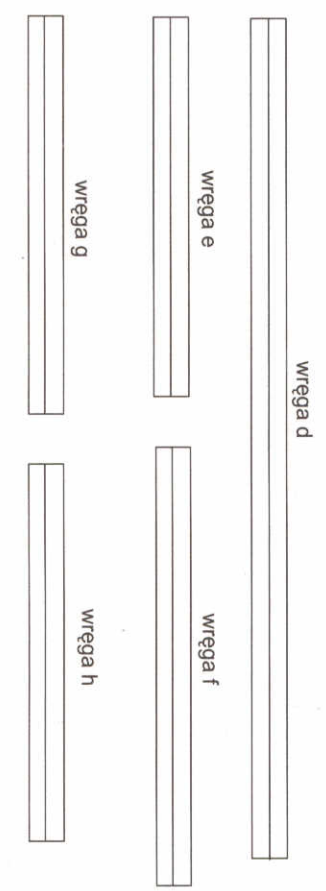
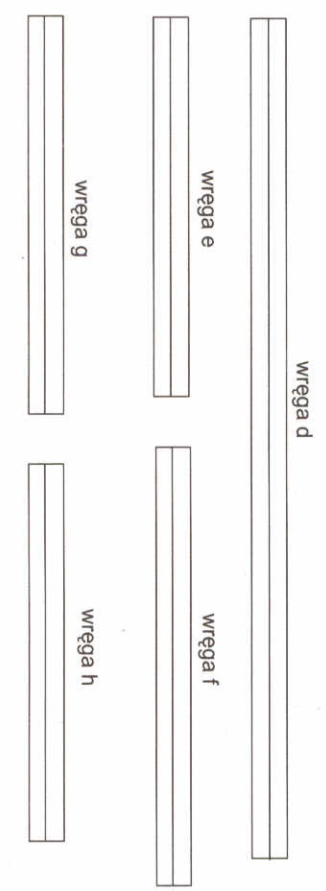
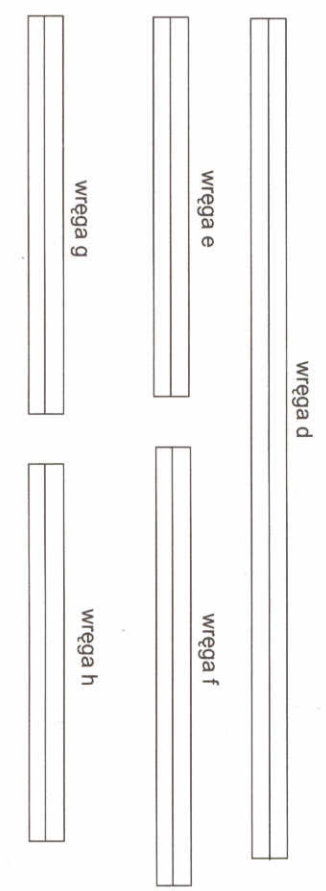
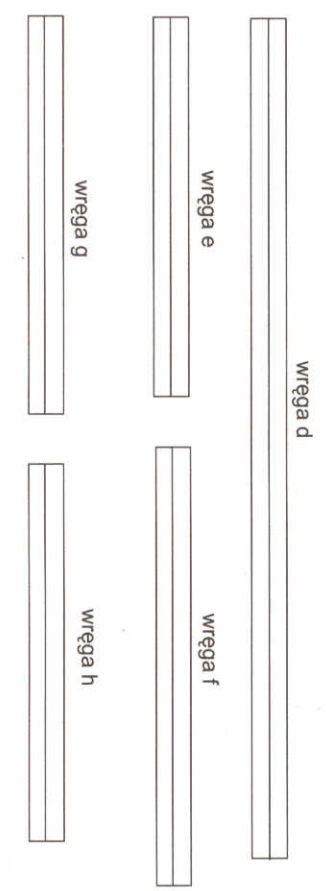
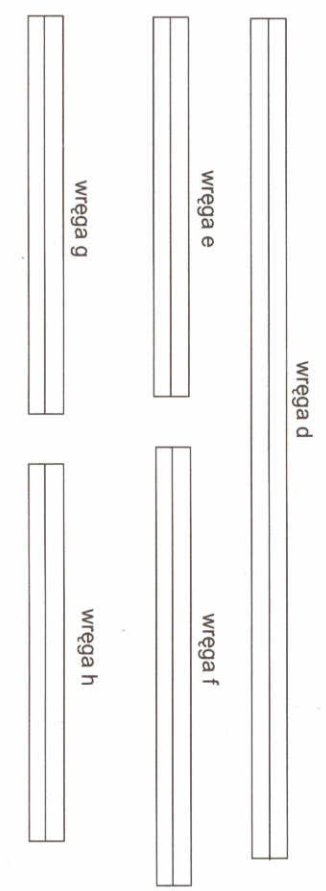
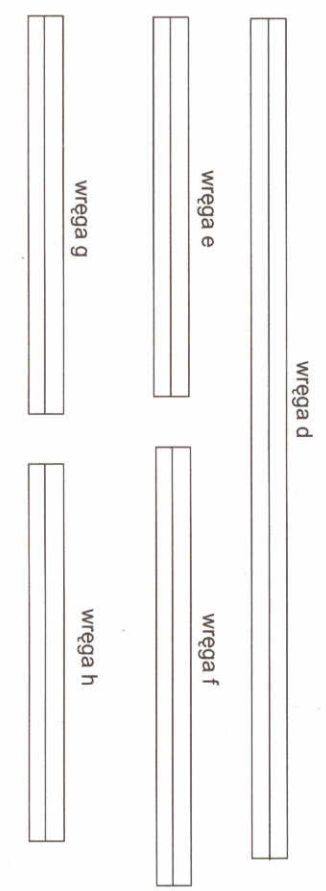
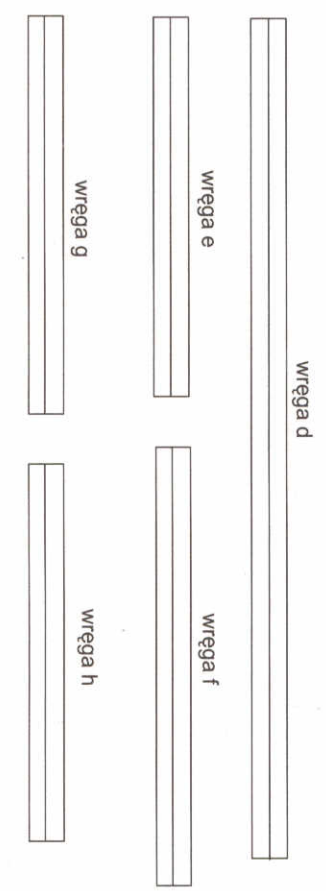
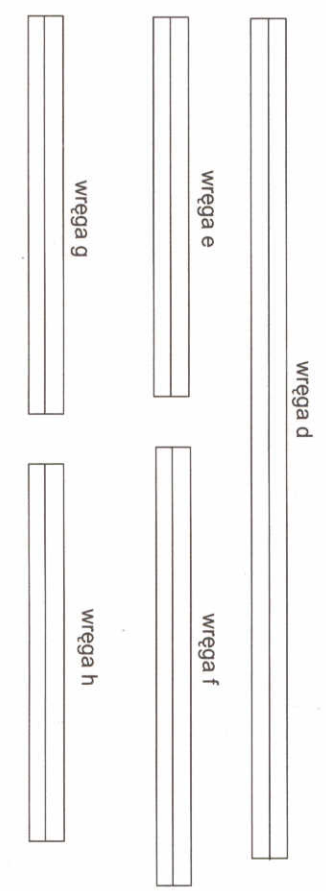
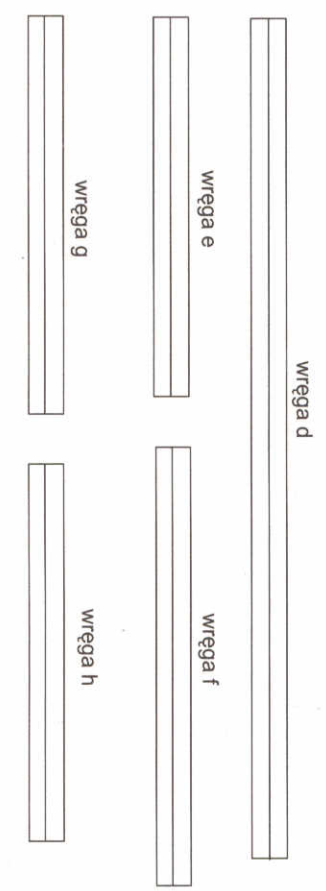
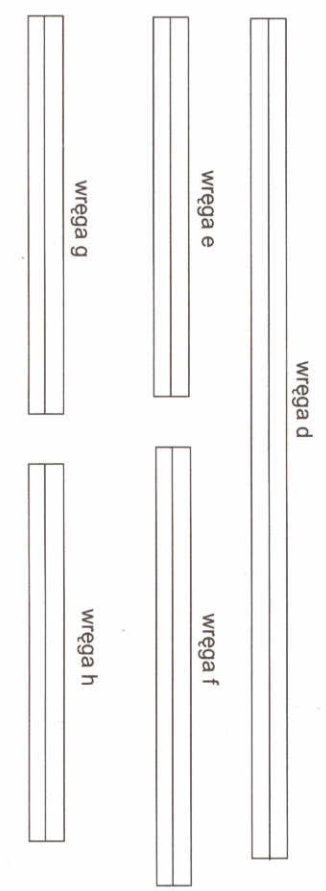
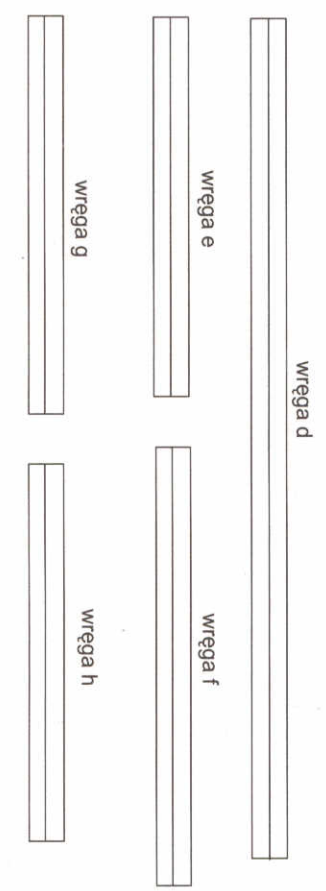
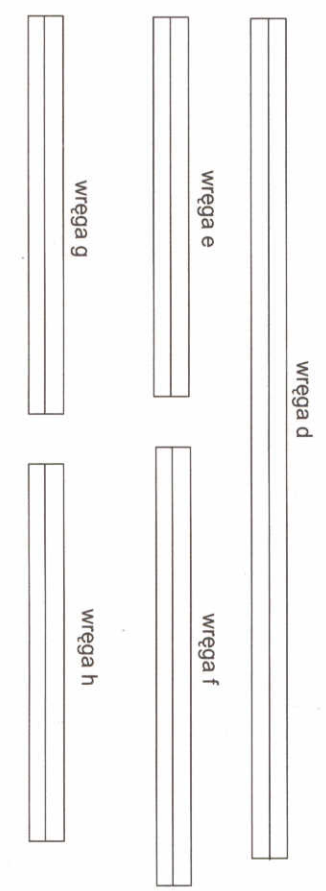
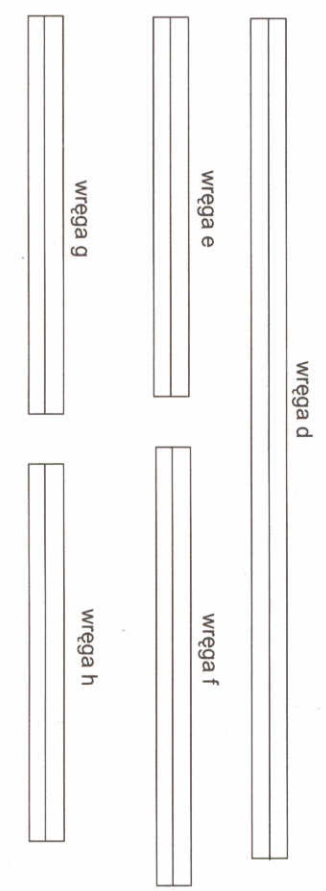
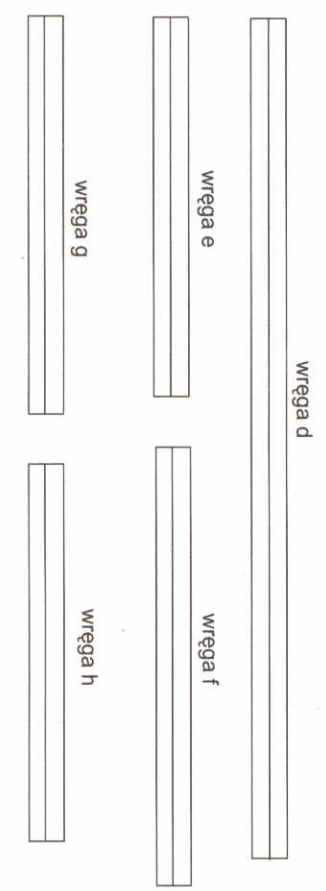
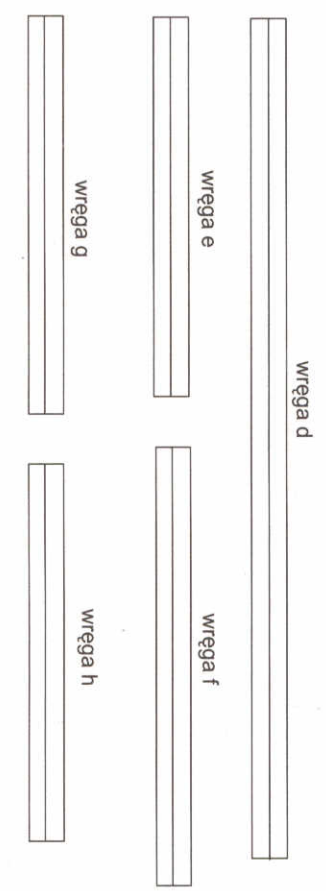
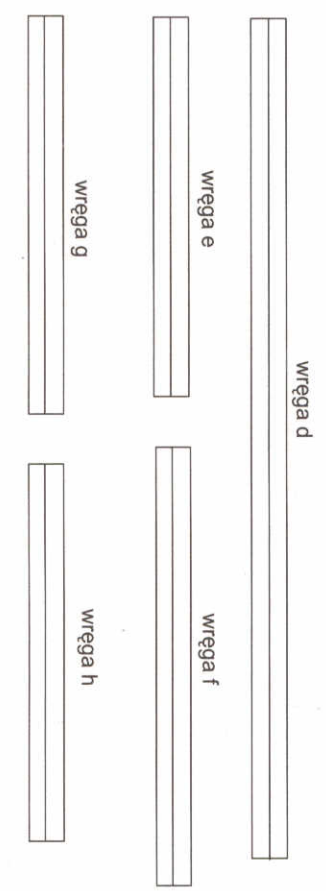
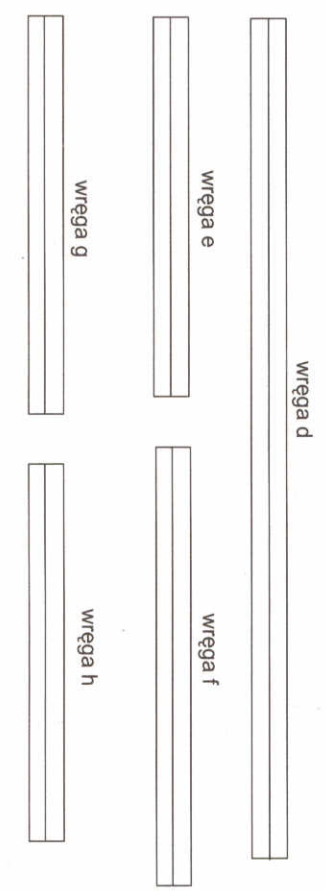
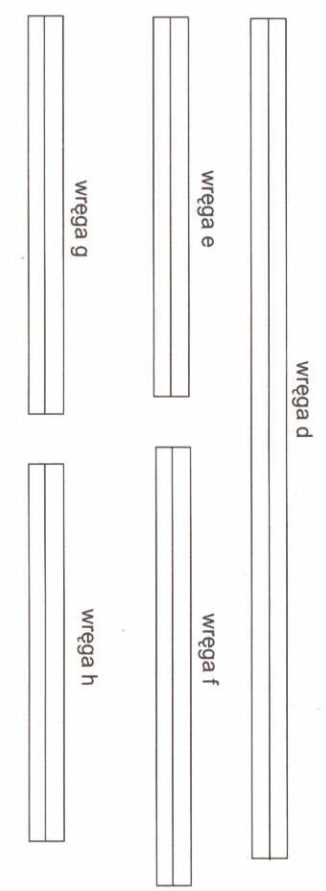
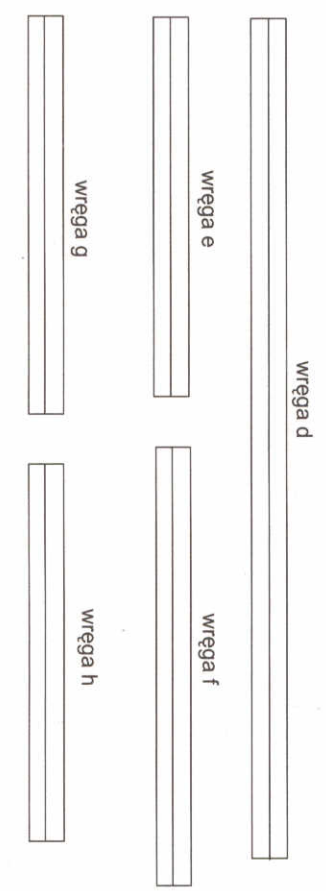
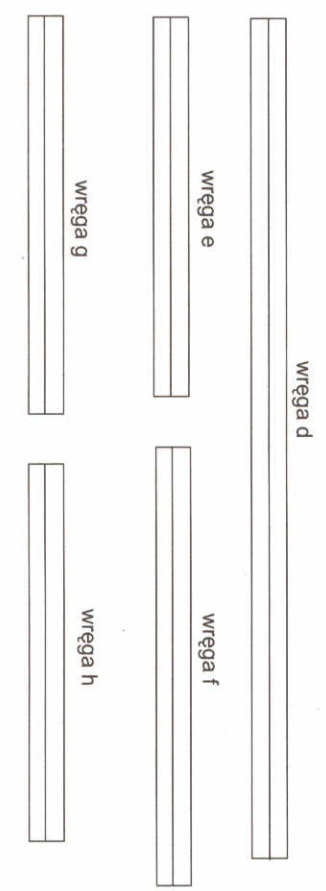
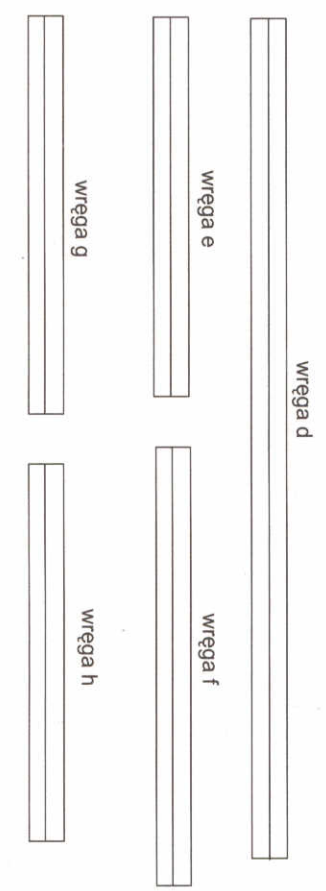
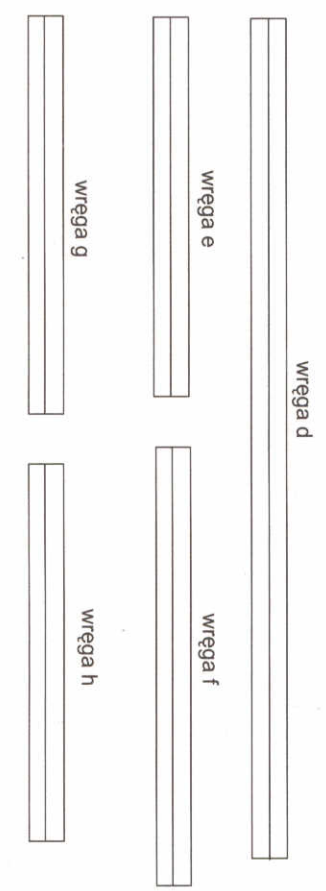
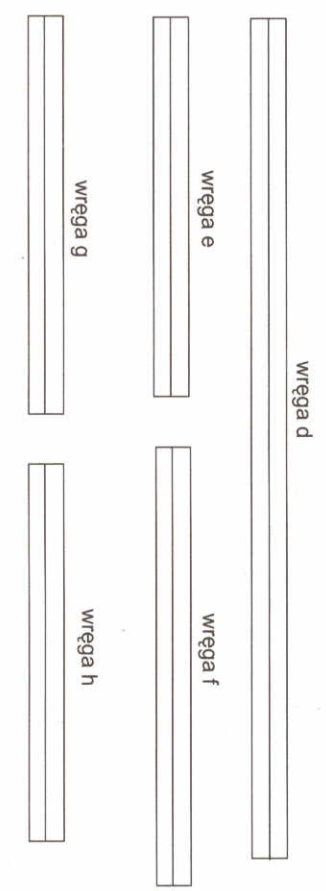
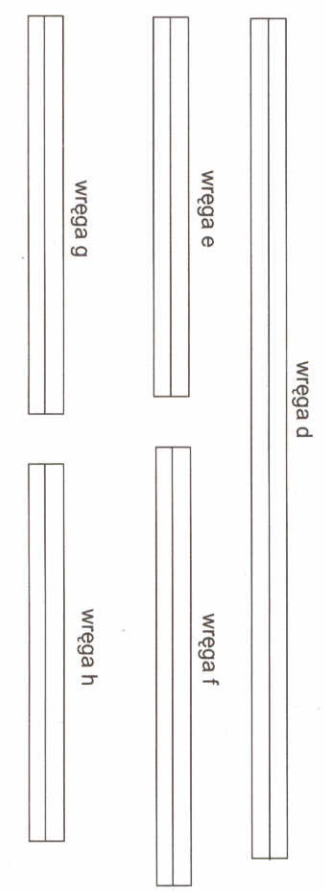
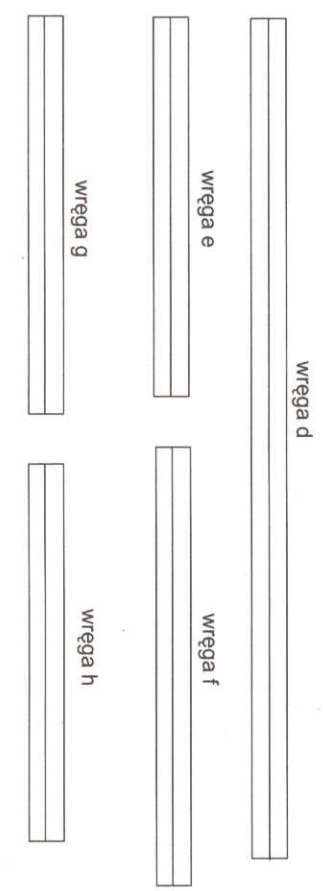
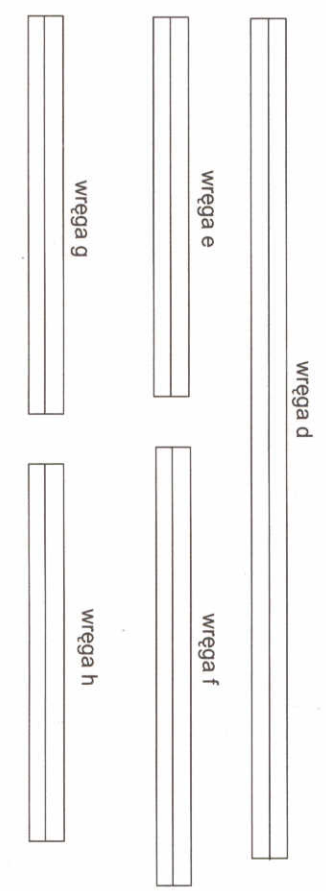
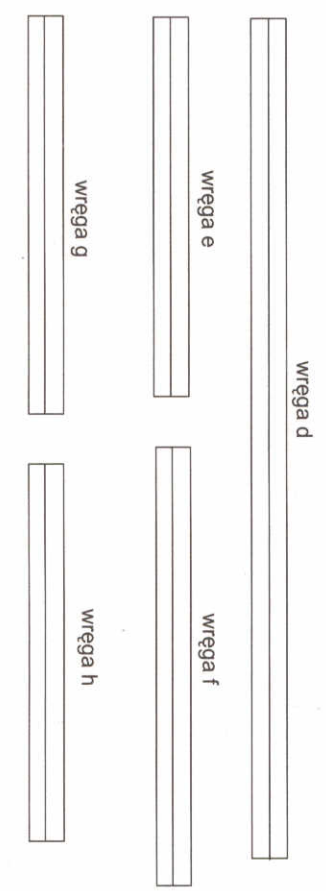
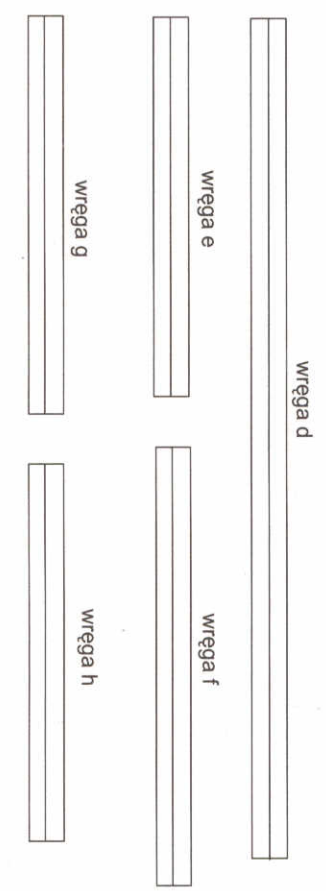
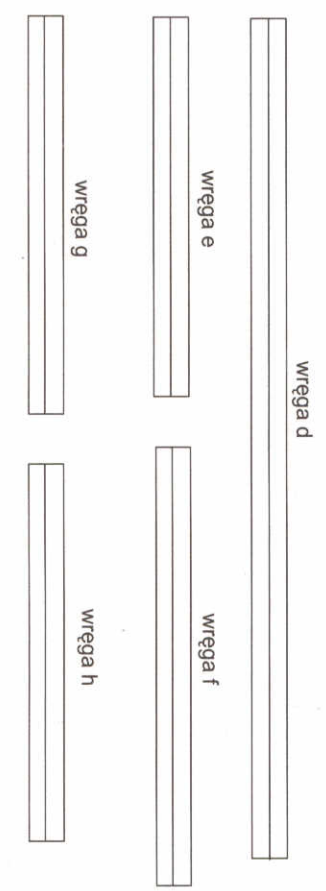
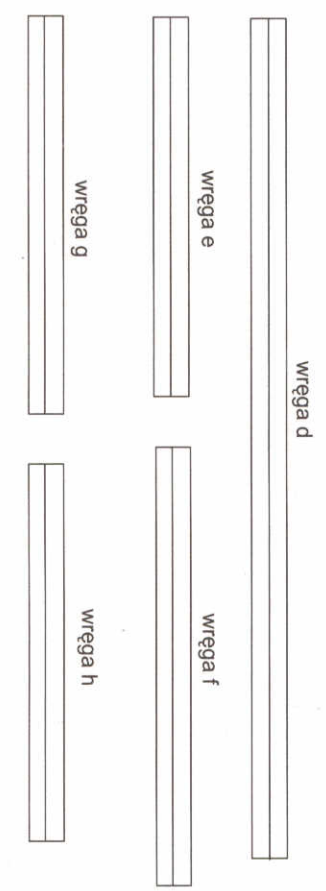
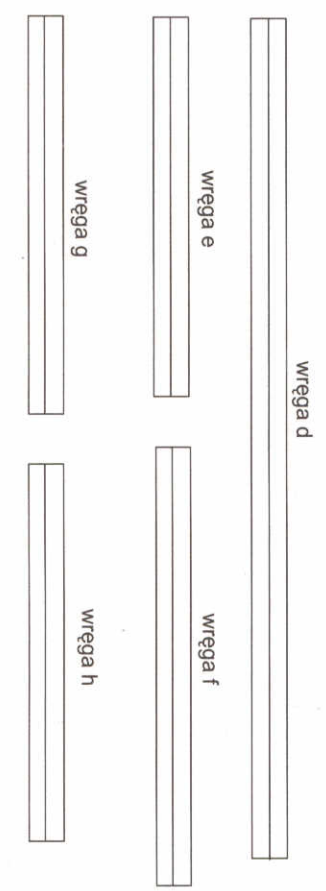
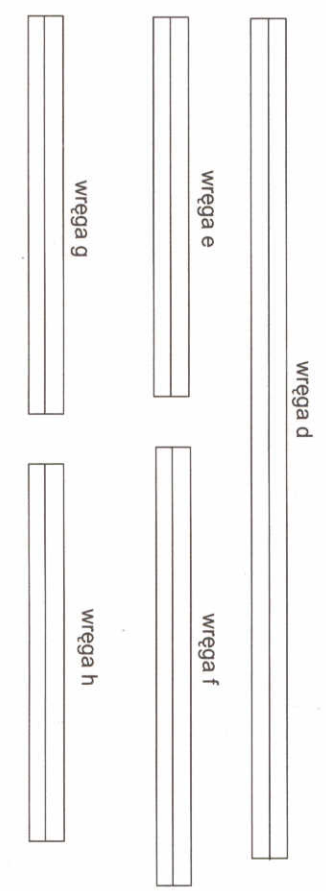
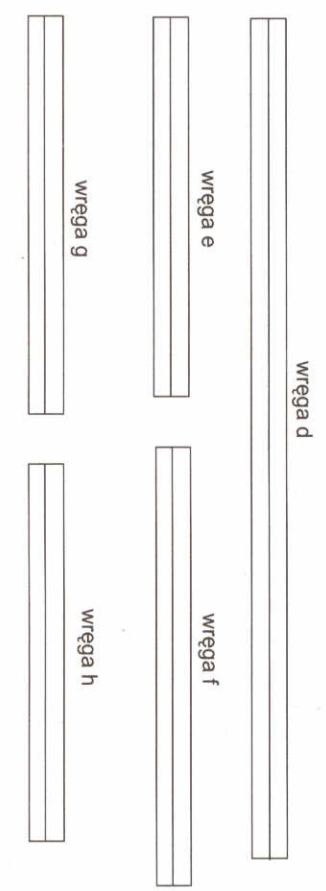
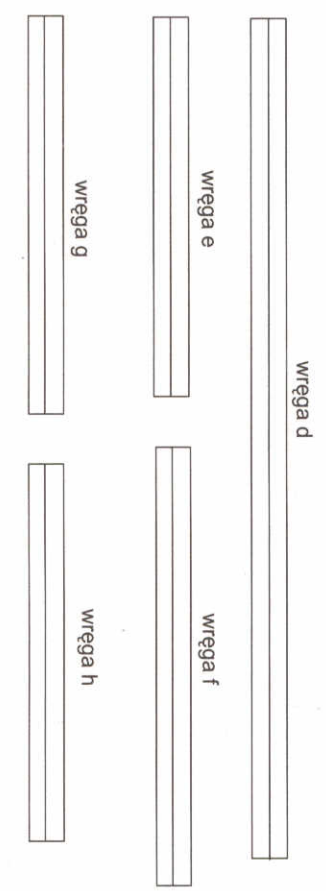
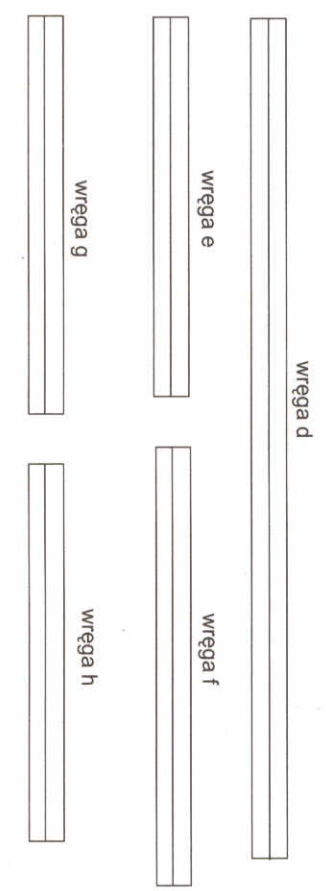
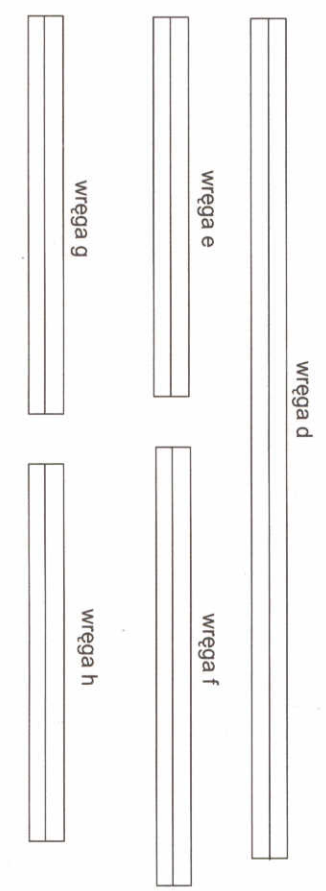
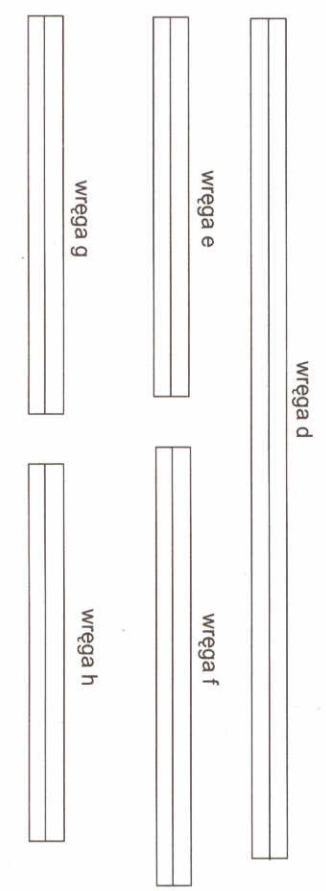
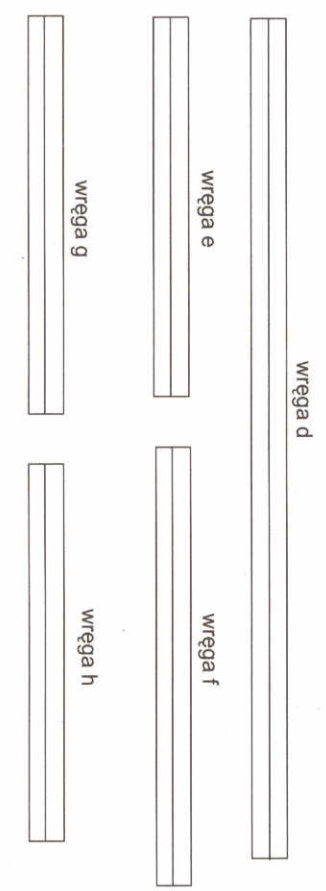
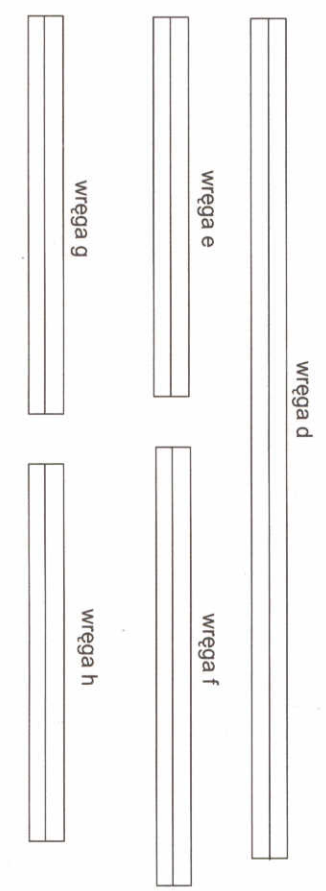
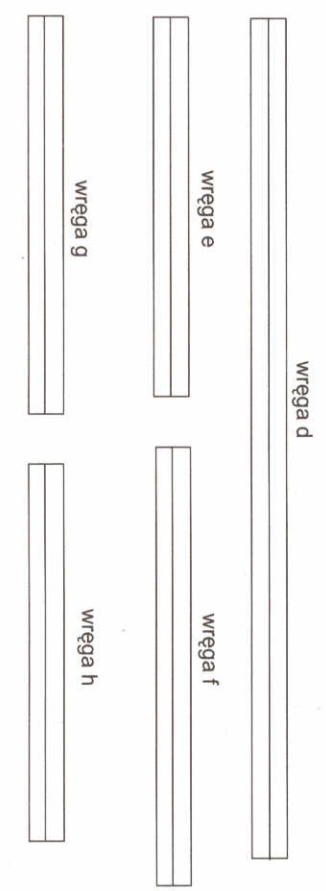
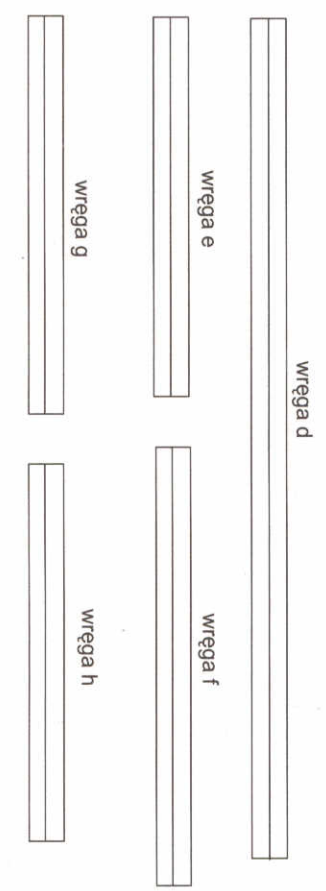
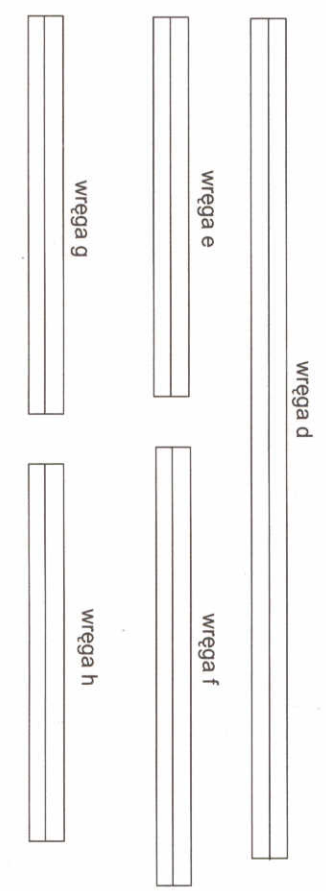
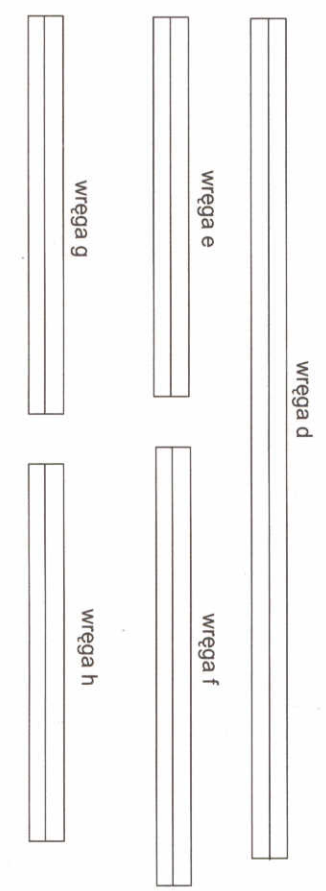
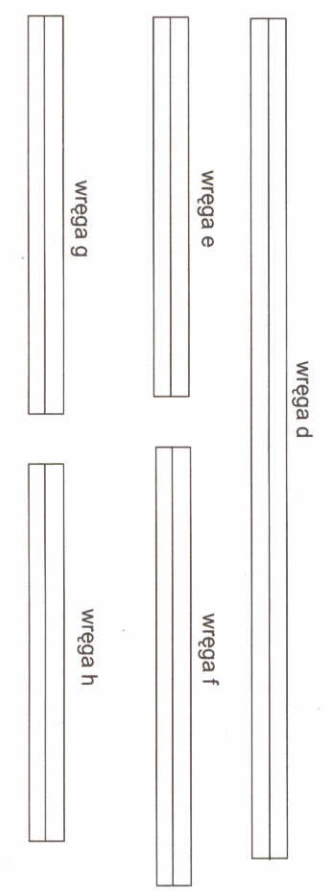
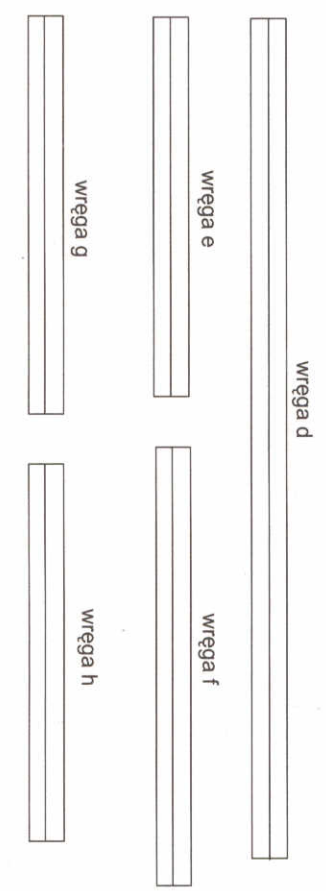
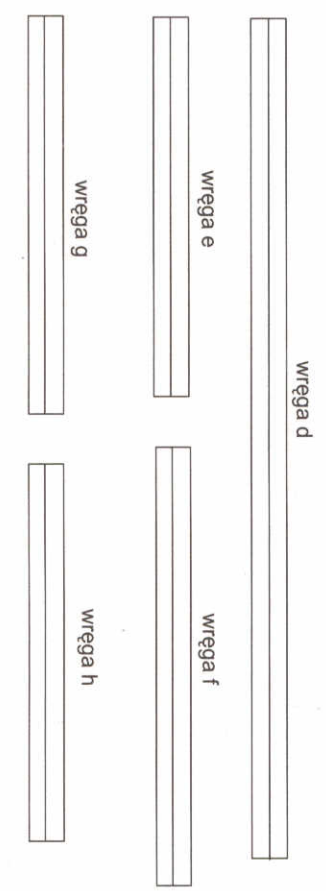
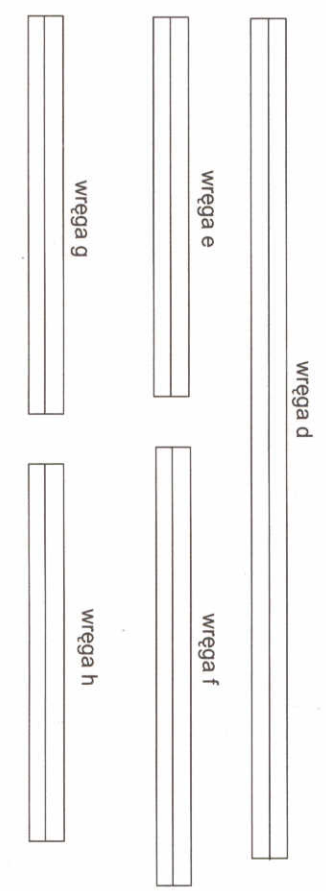
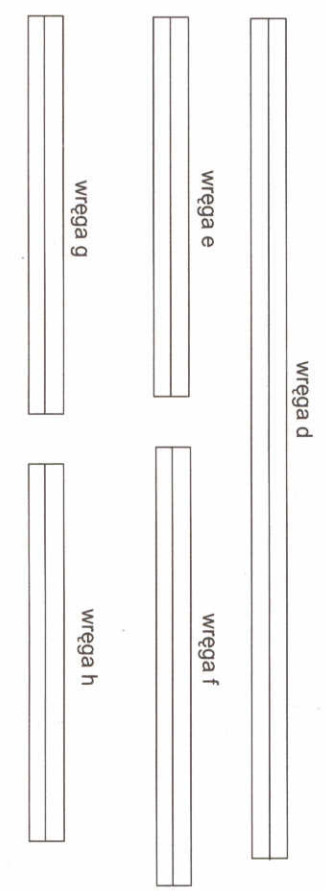
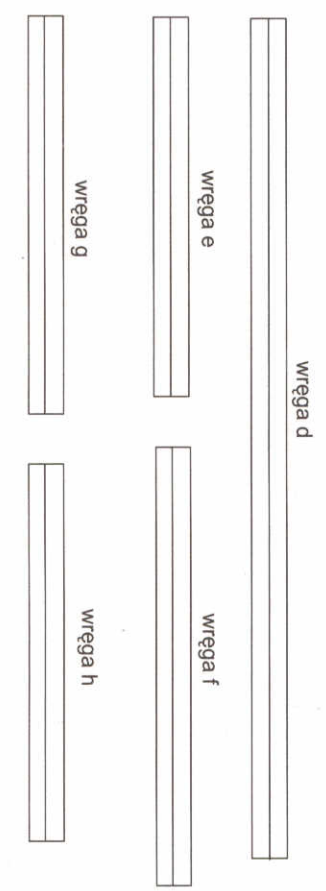
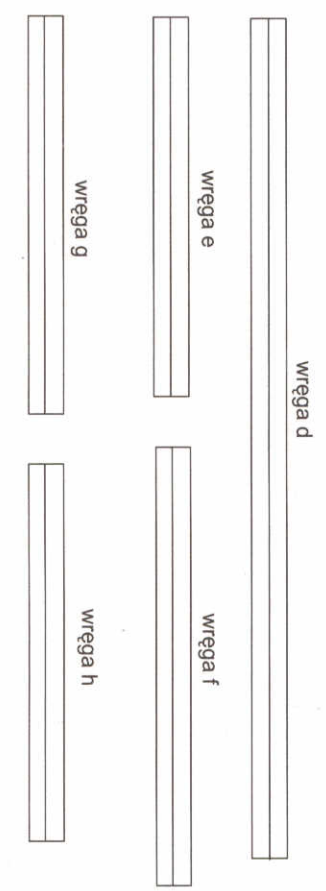
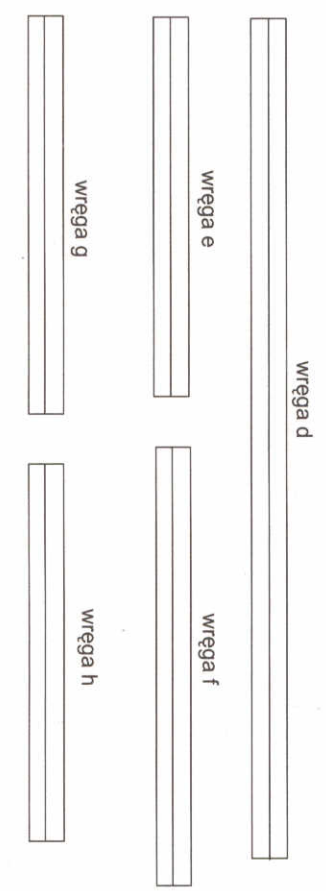
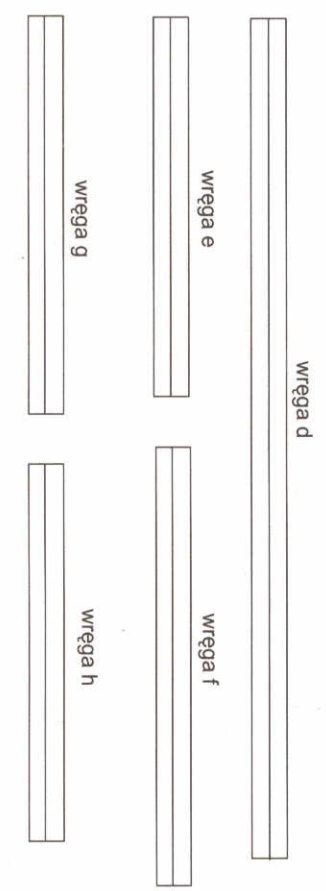
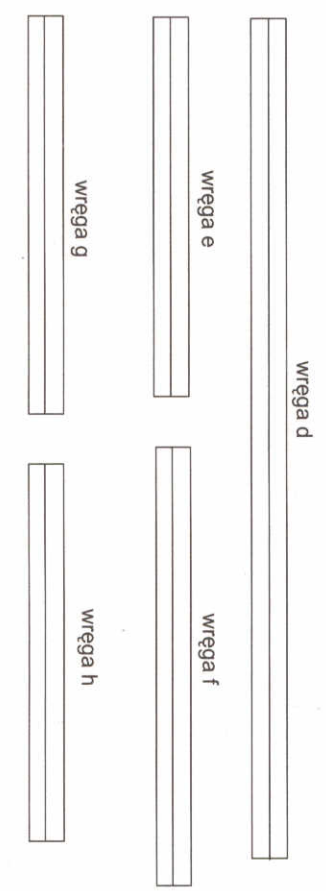
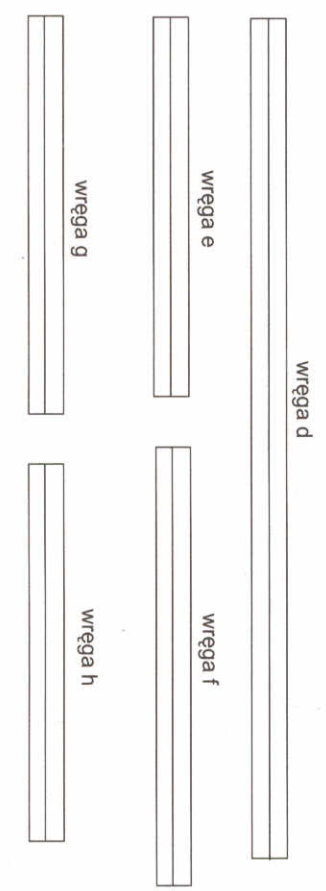
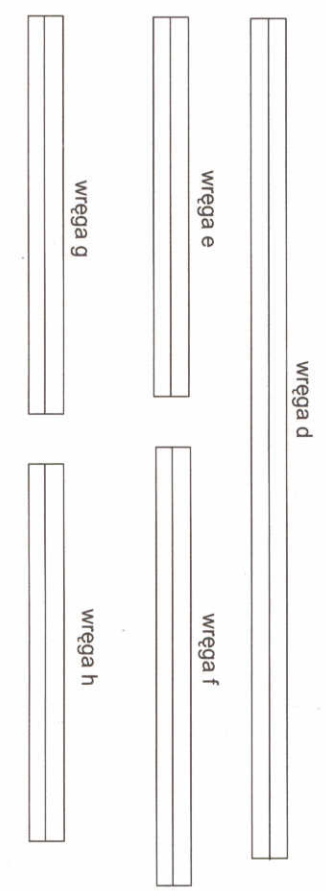
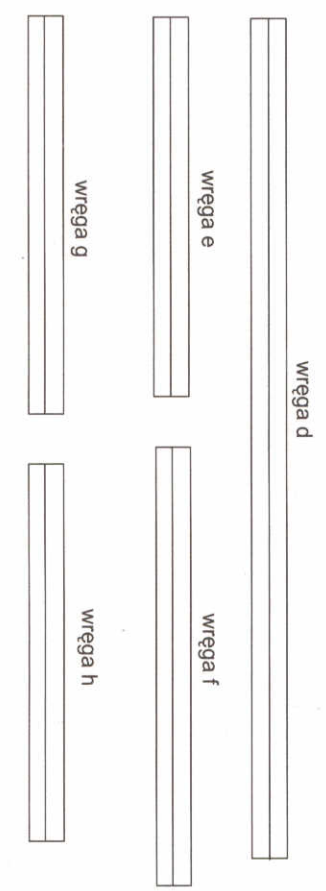
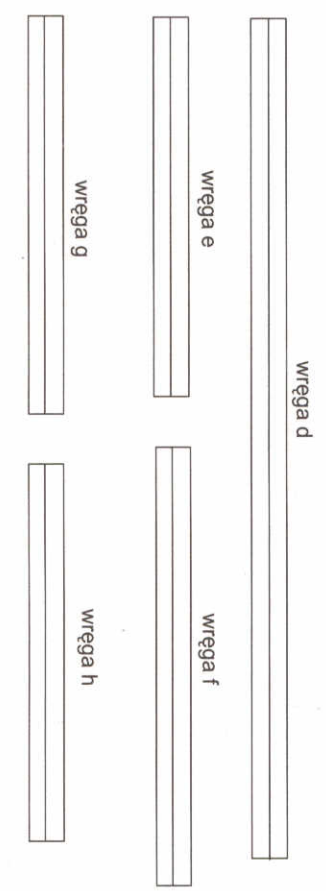
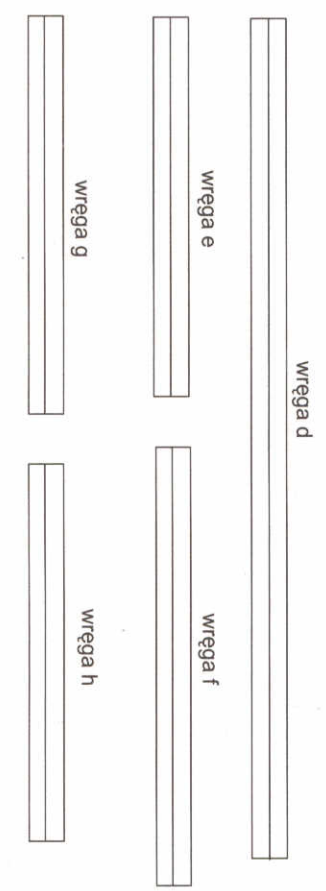
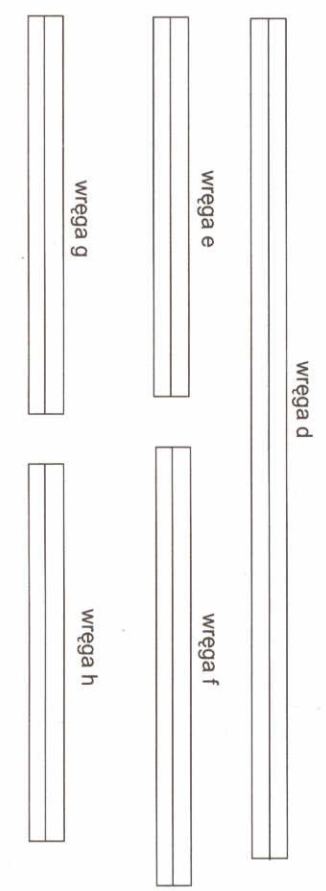
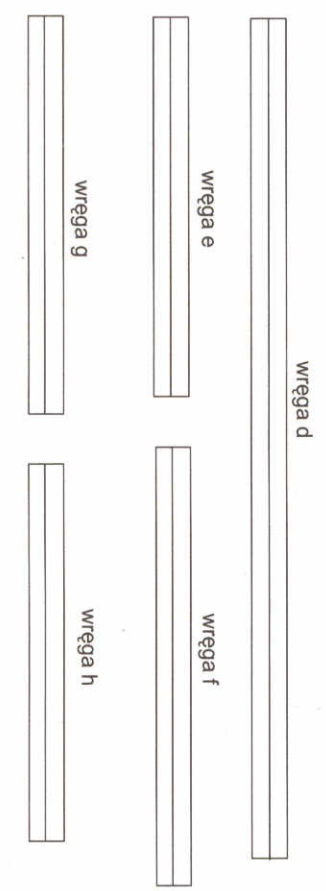
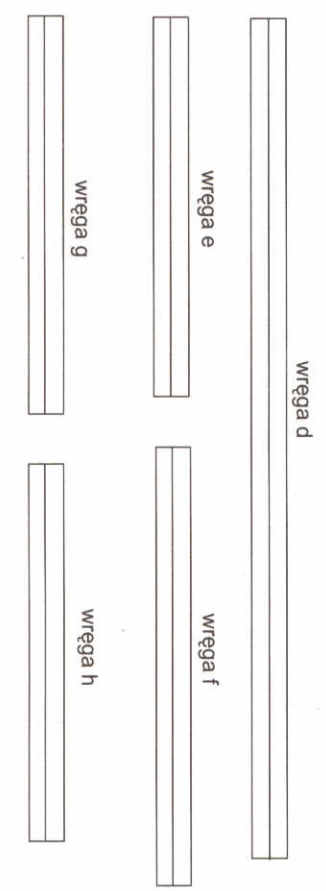
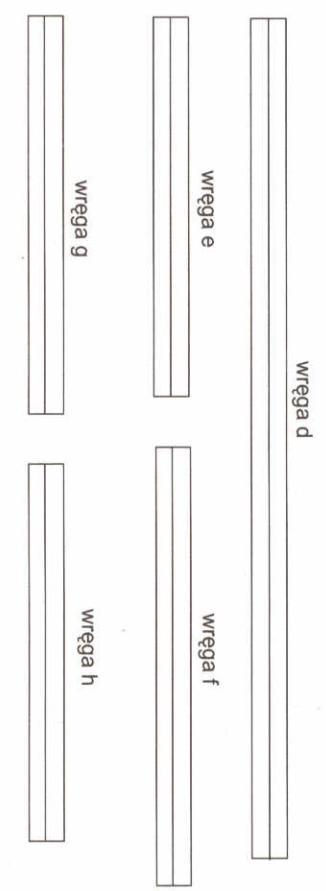
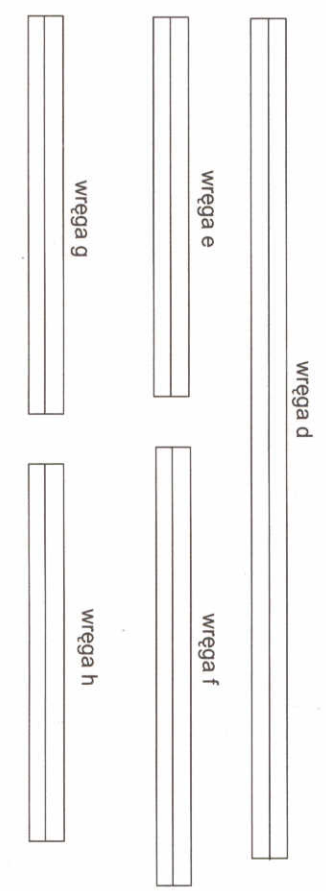
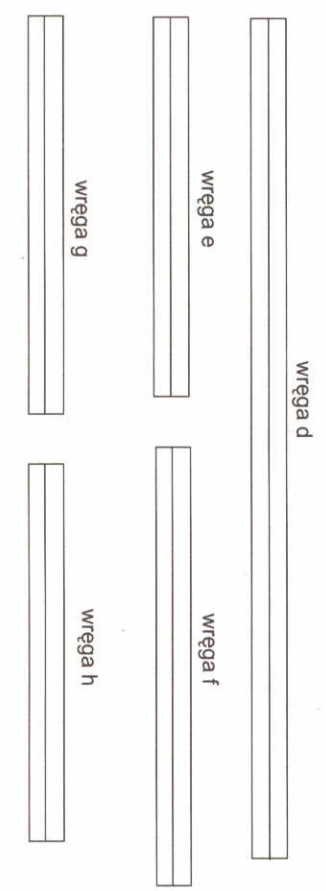
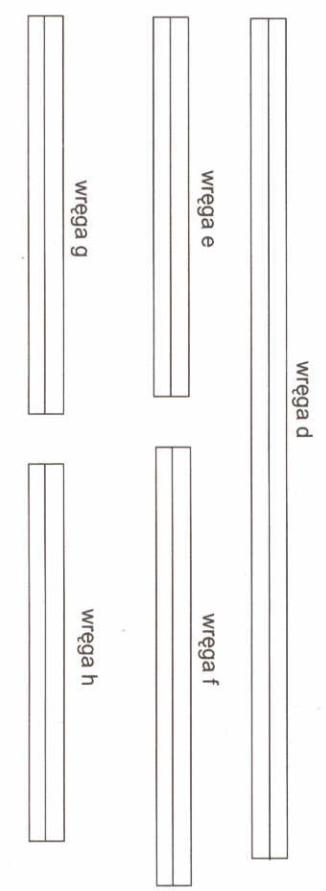
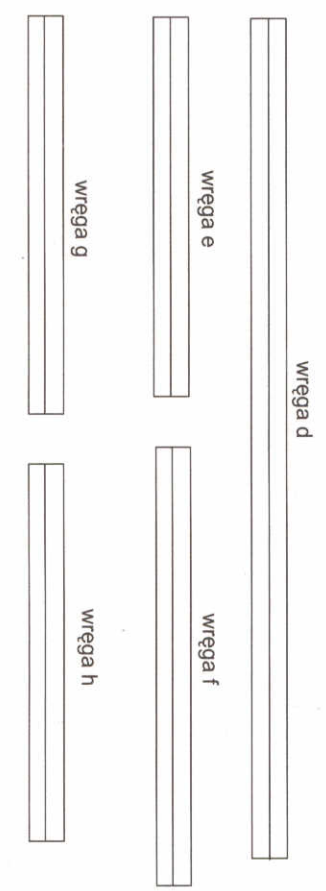
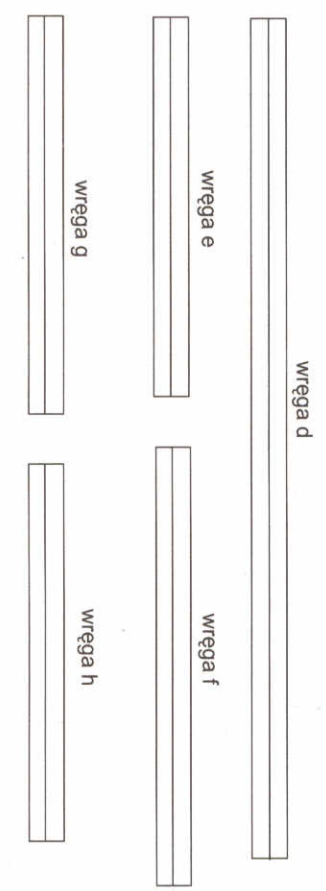
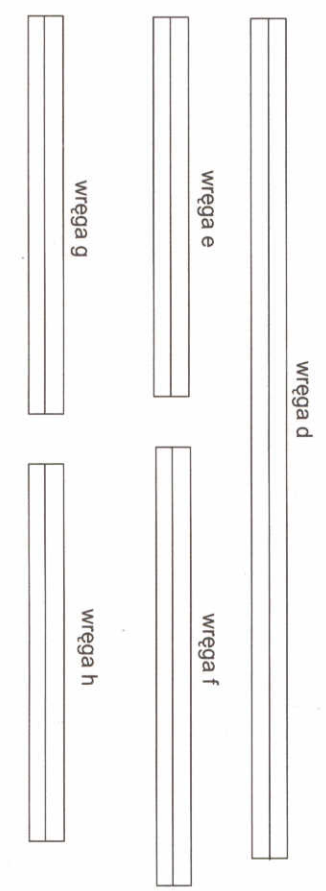
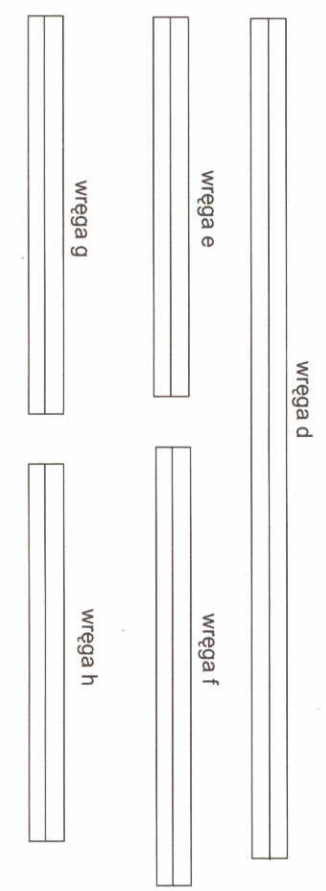
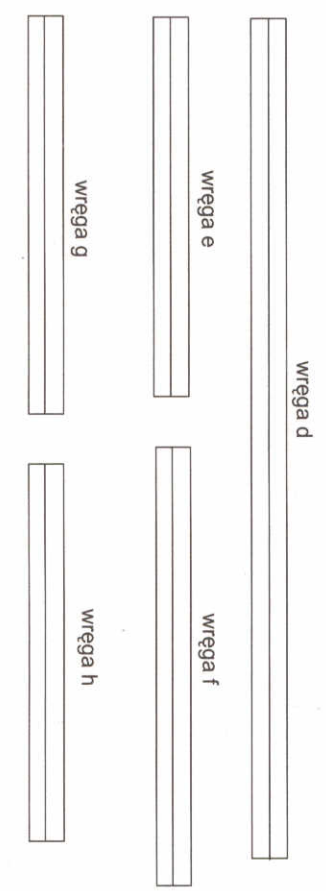
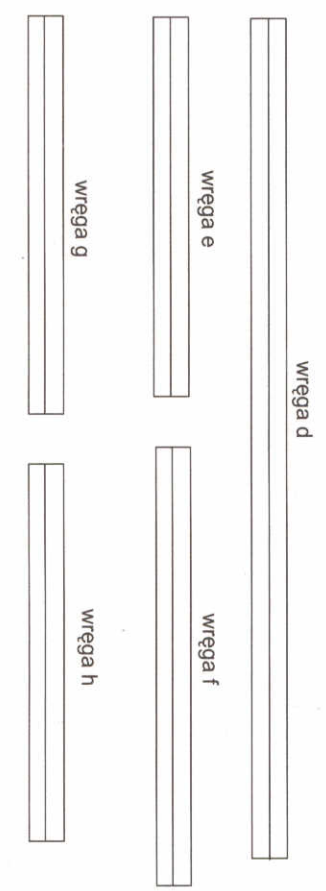
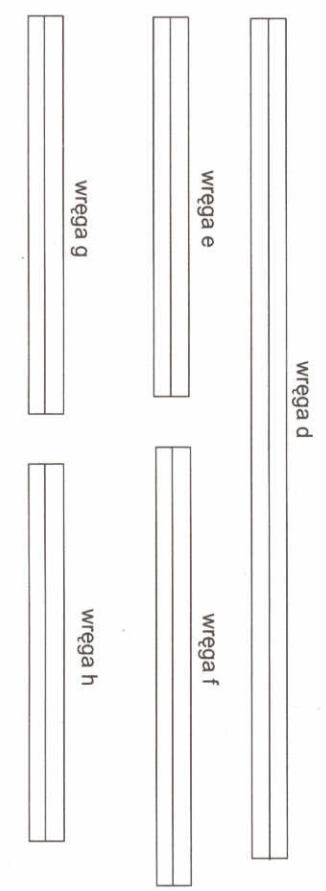
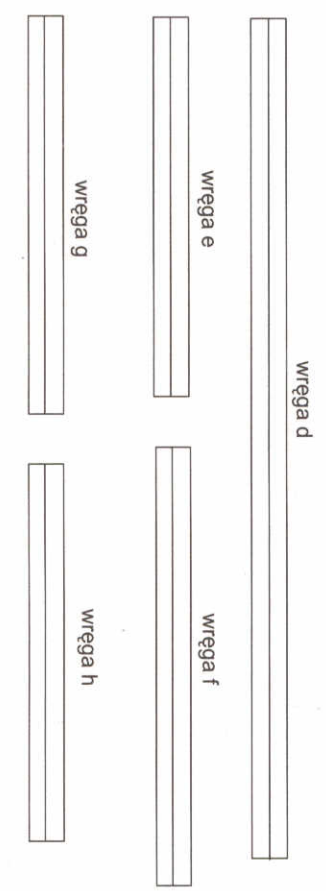
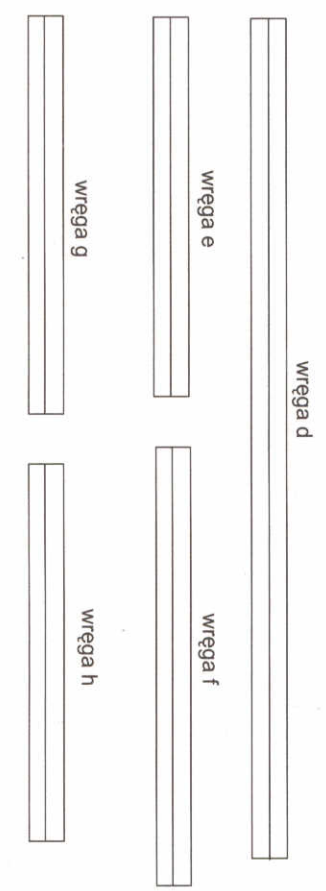
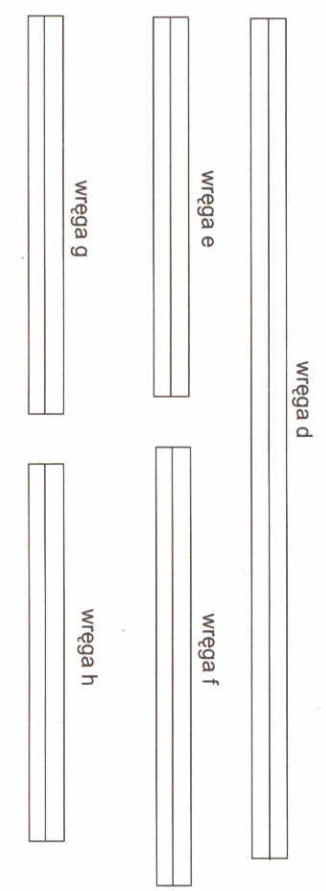
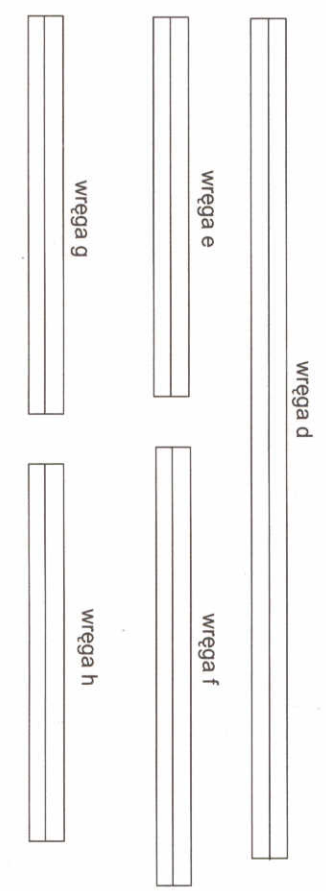
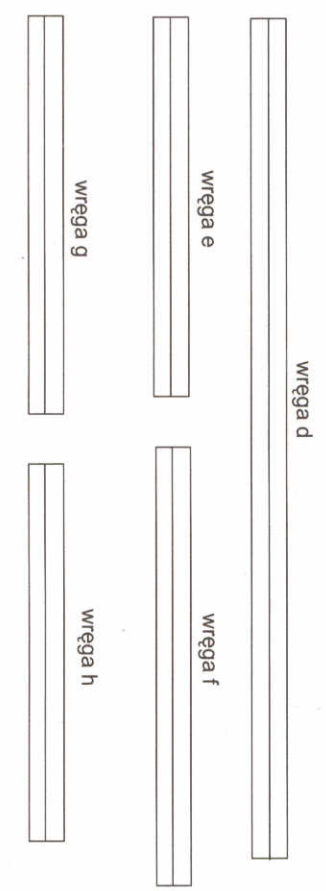
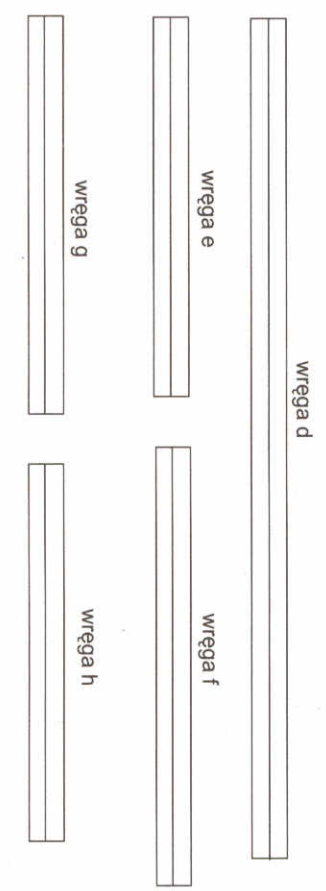
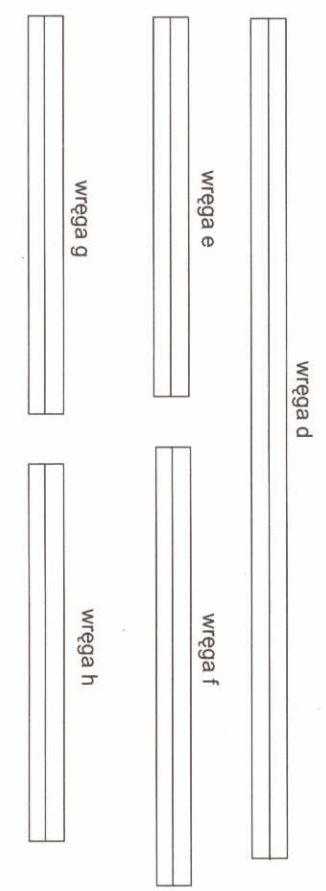
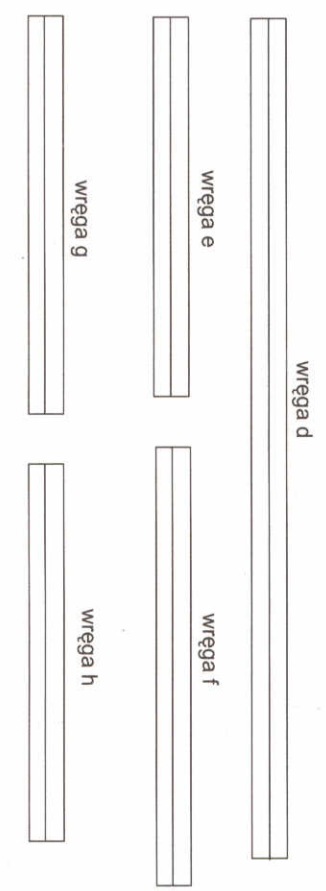
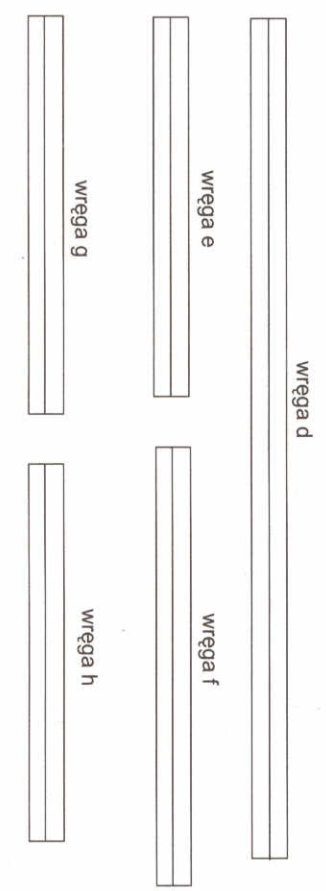
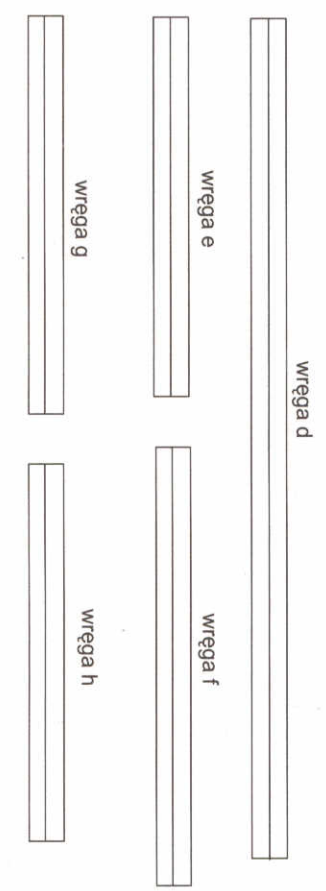
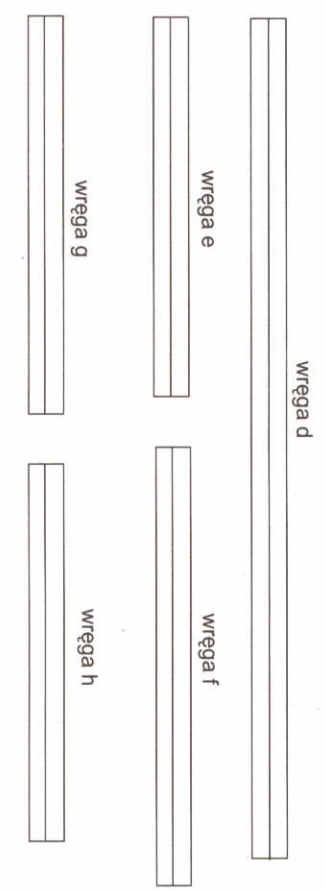
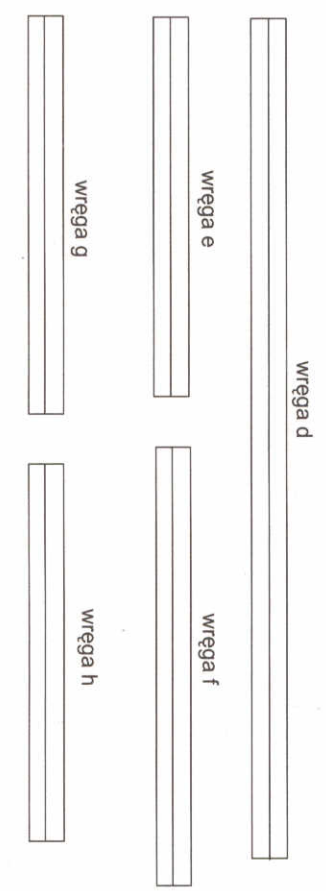
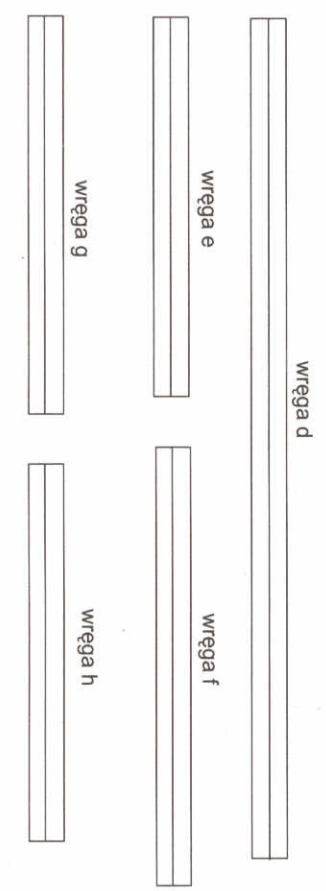
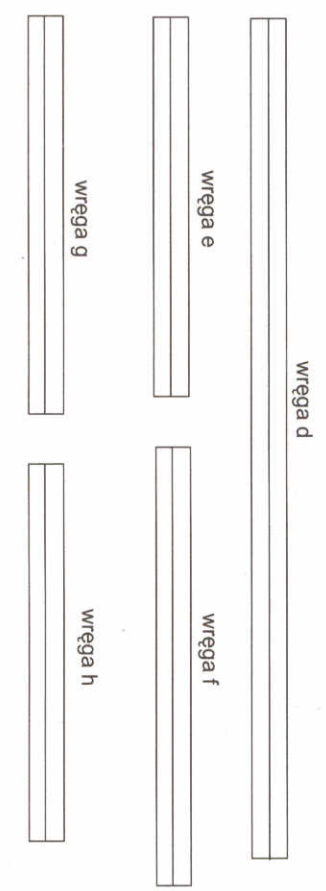
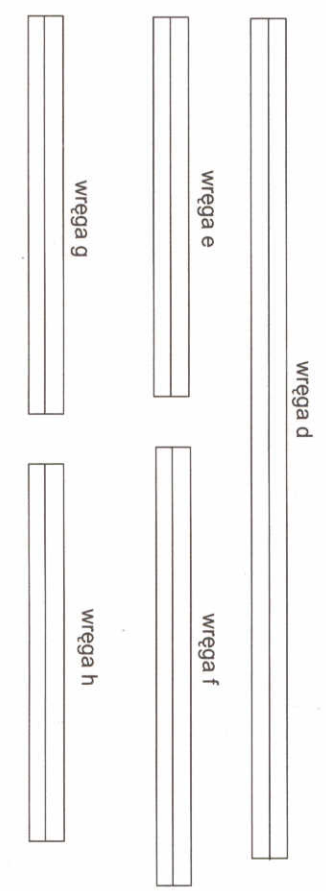
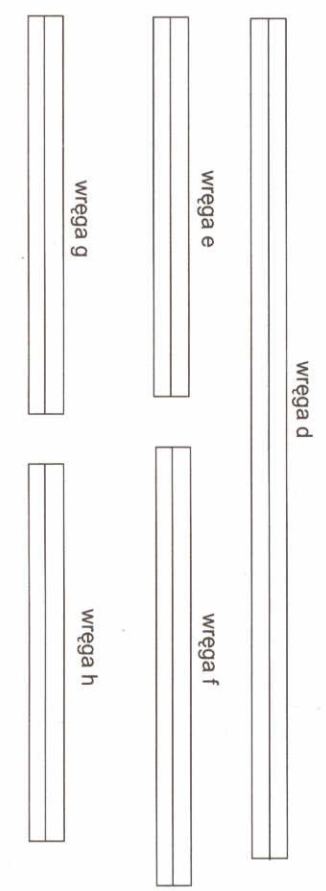
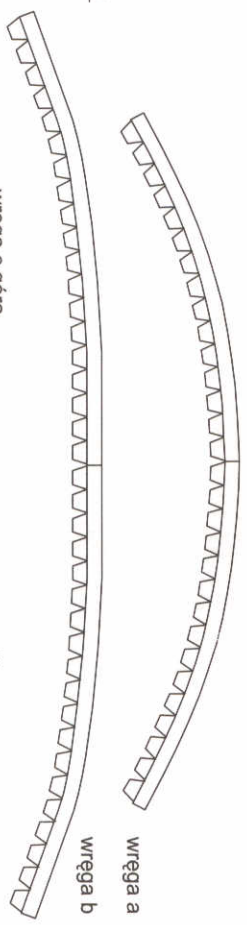
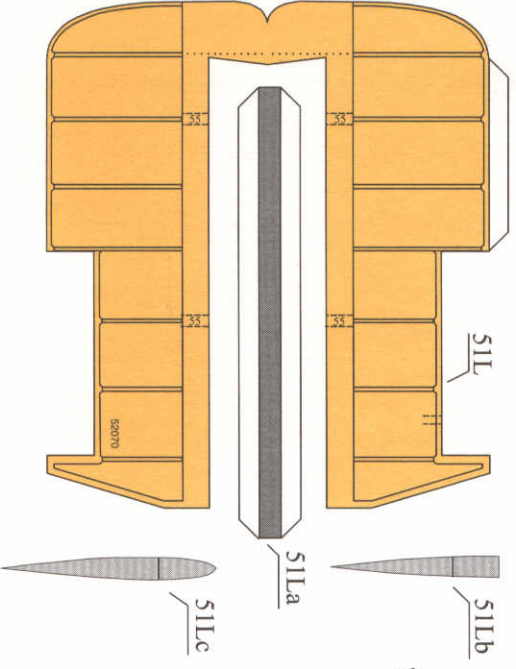
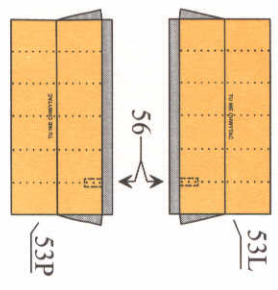
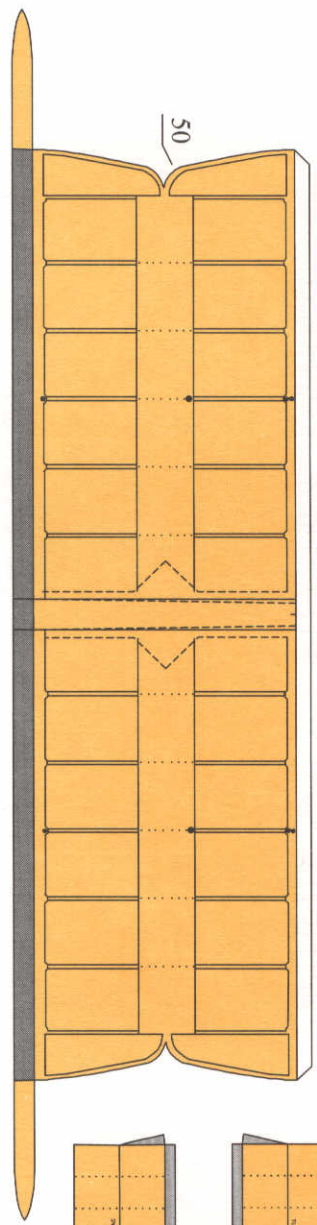
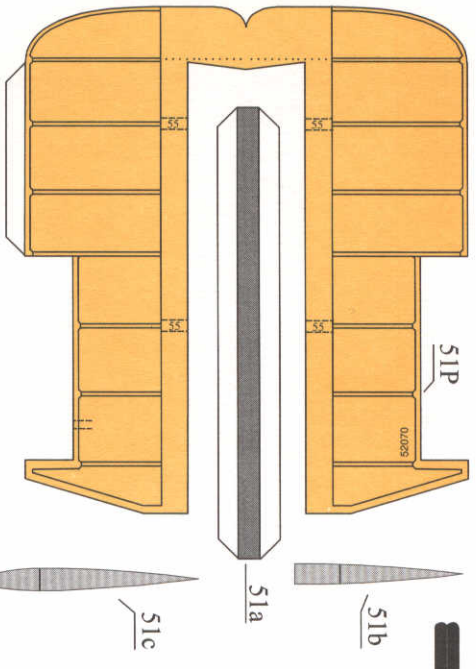
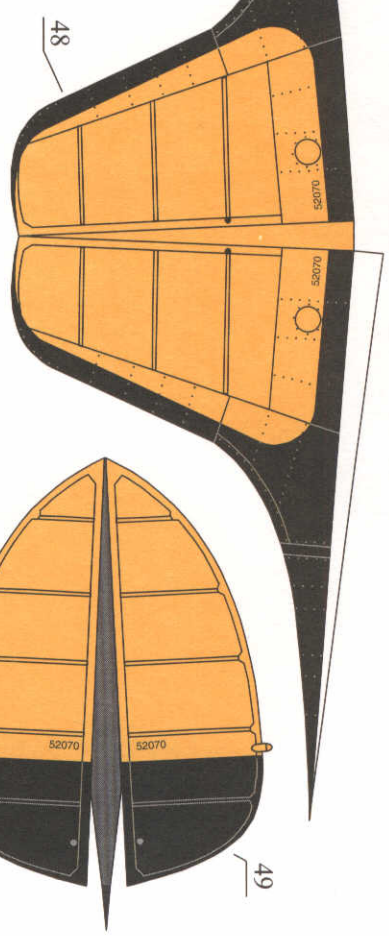
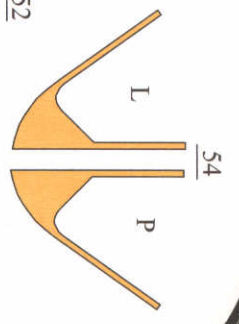
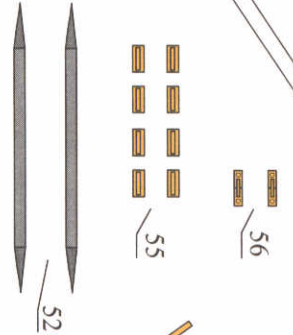
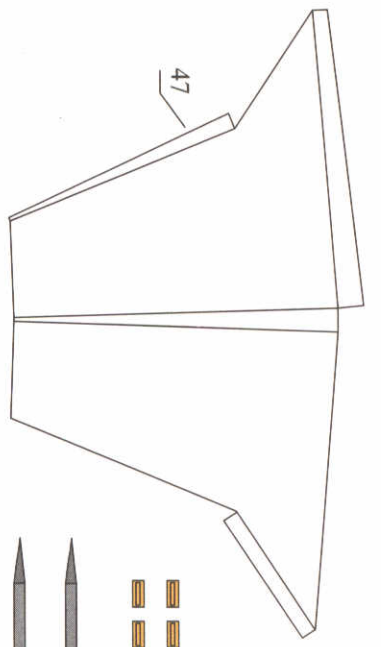

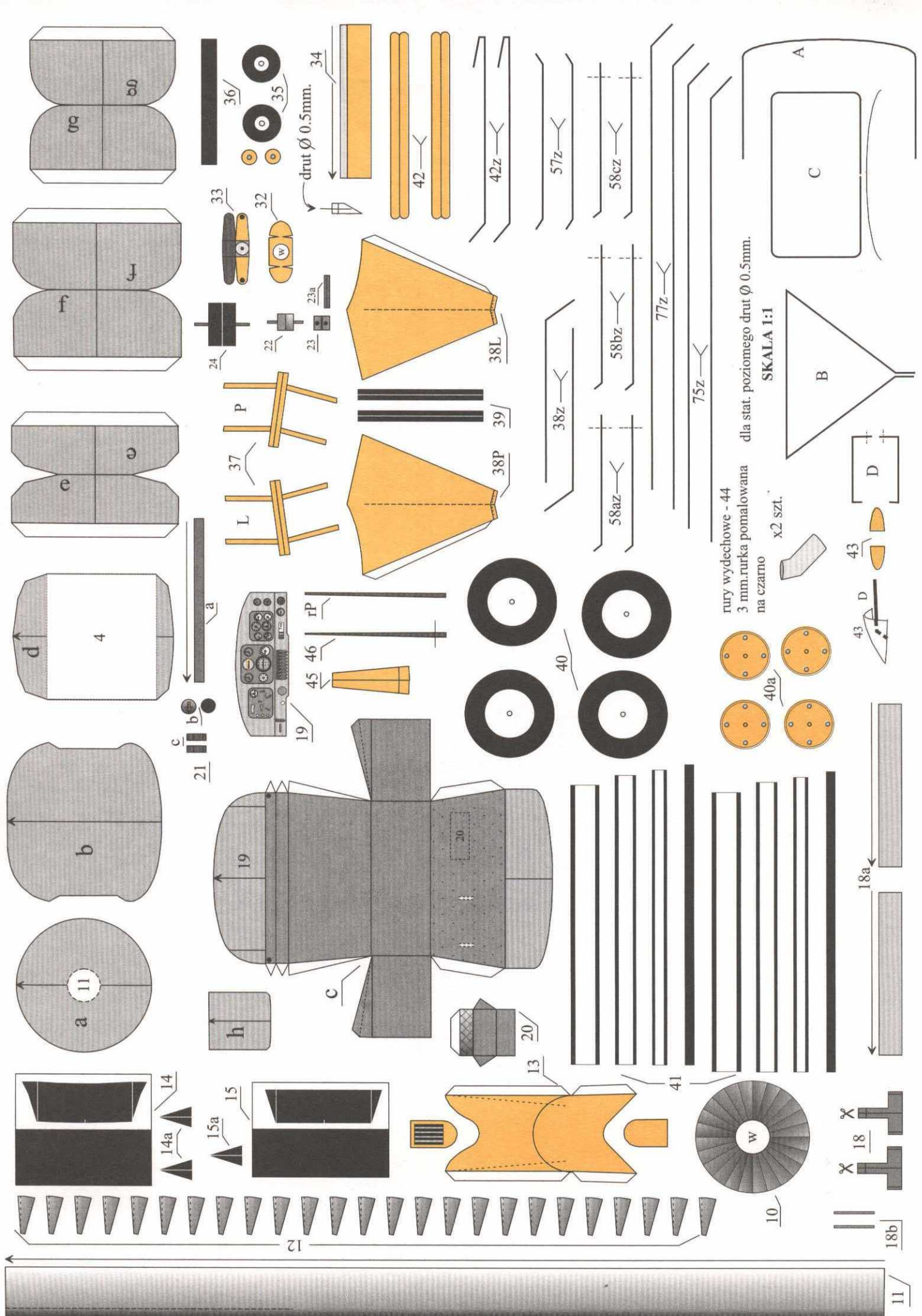

dla stat. poziomego drut  $\varnothing 0.5\text{mm}$ .

SKALA 1:1

rury wydechowe - 44  
3 mm.rurka pomalowana  
na czarno

x2 szt.

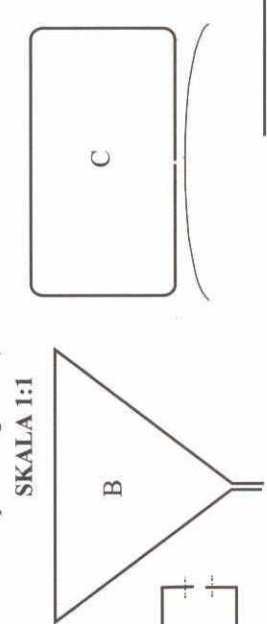
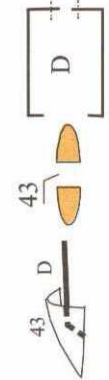
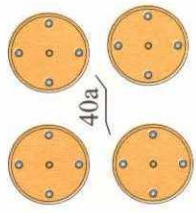

75z

77z

58az

58bz

38z

38L

38P

39

45

46

rP

21

c

b

a

4

d

e

f

j

0a

0b

h

19

19

22

23

24

32

33

36

34

35

37

L

P

w

23a

42

42z

57z

58cz

77z

75z

40

40a

43

43

D

18

18a

18b

10

11

12

13

14

14a

15

15a

20

nakleć na karton



24

27a

26a

szipilka



101

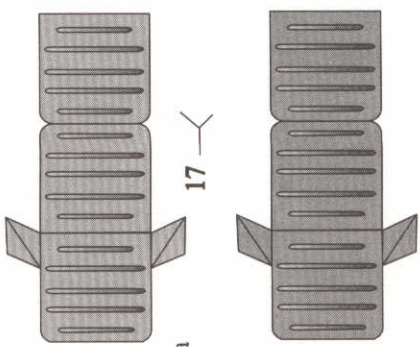

17

17a nakleć na karton



17a

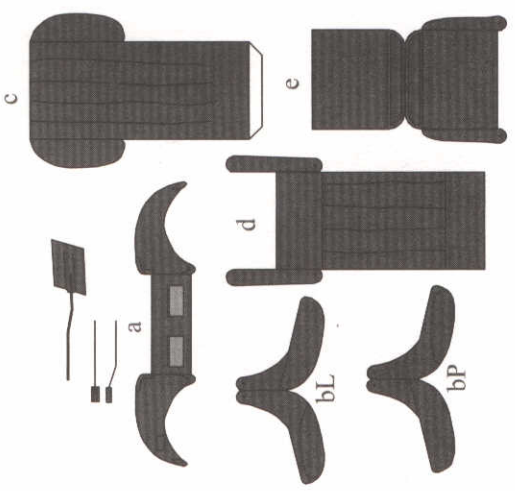

2x 16

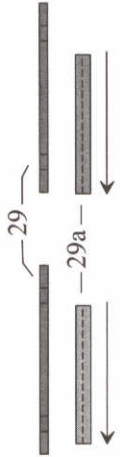
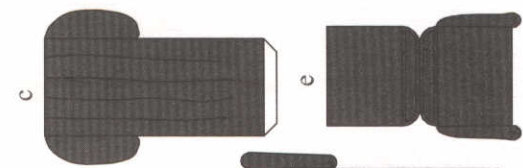

29

29a



30

4

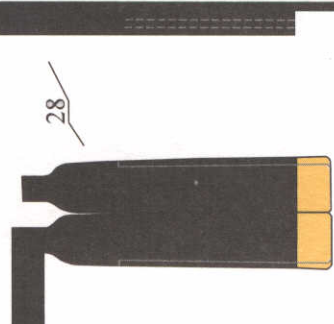
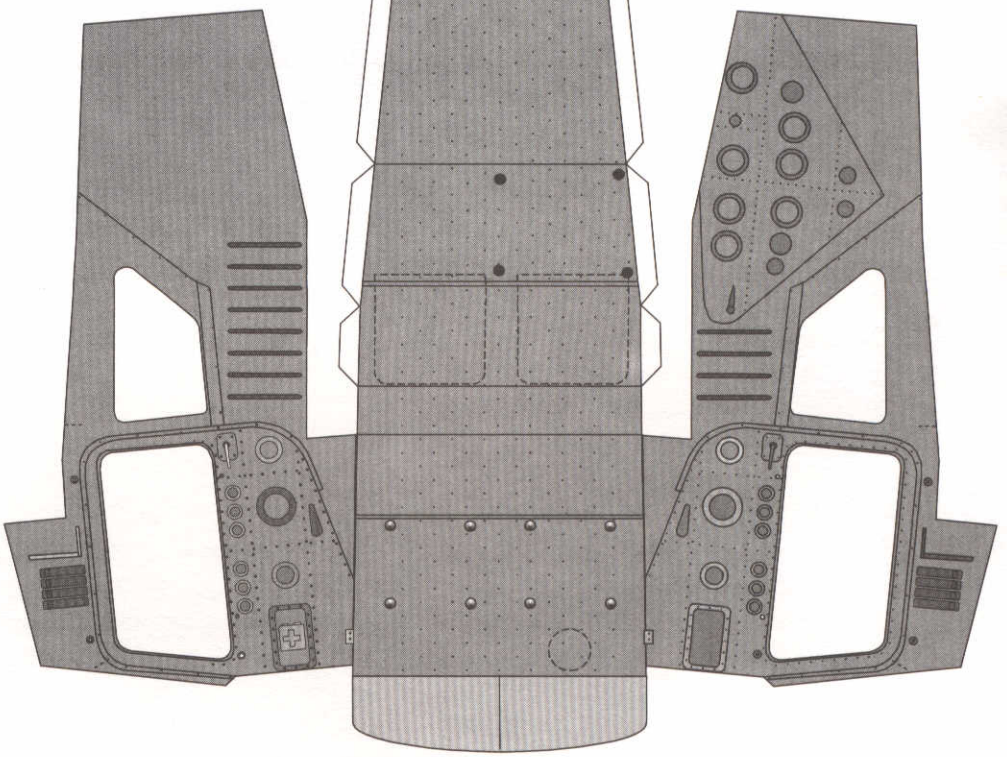

27

28

27a

26a

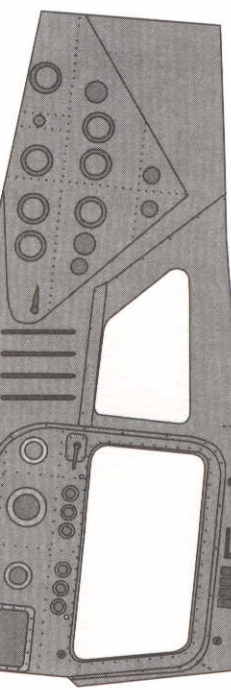
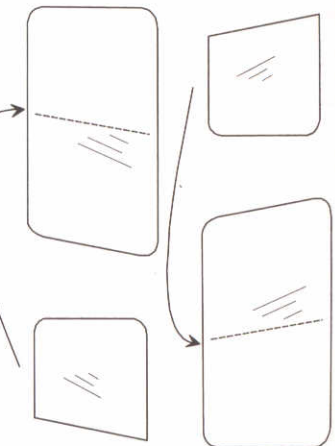
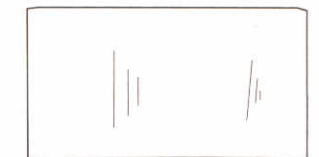
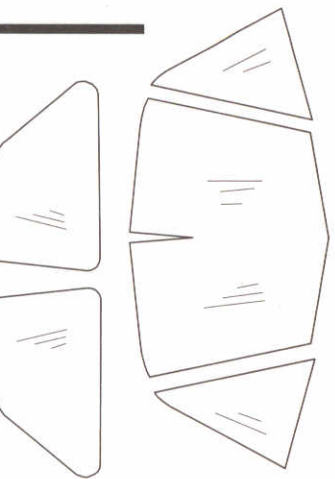

26

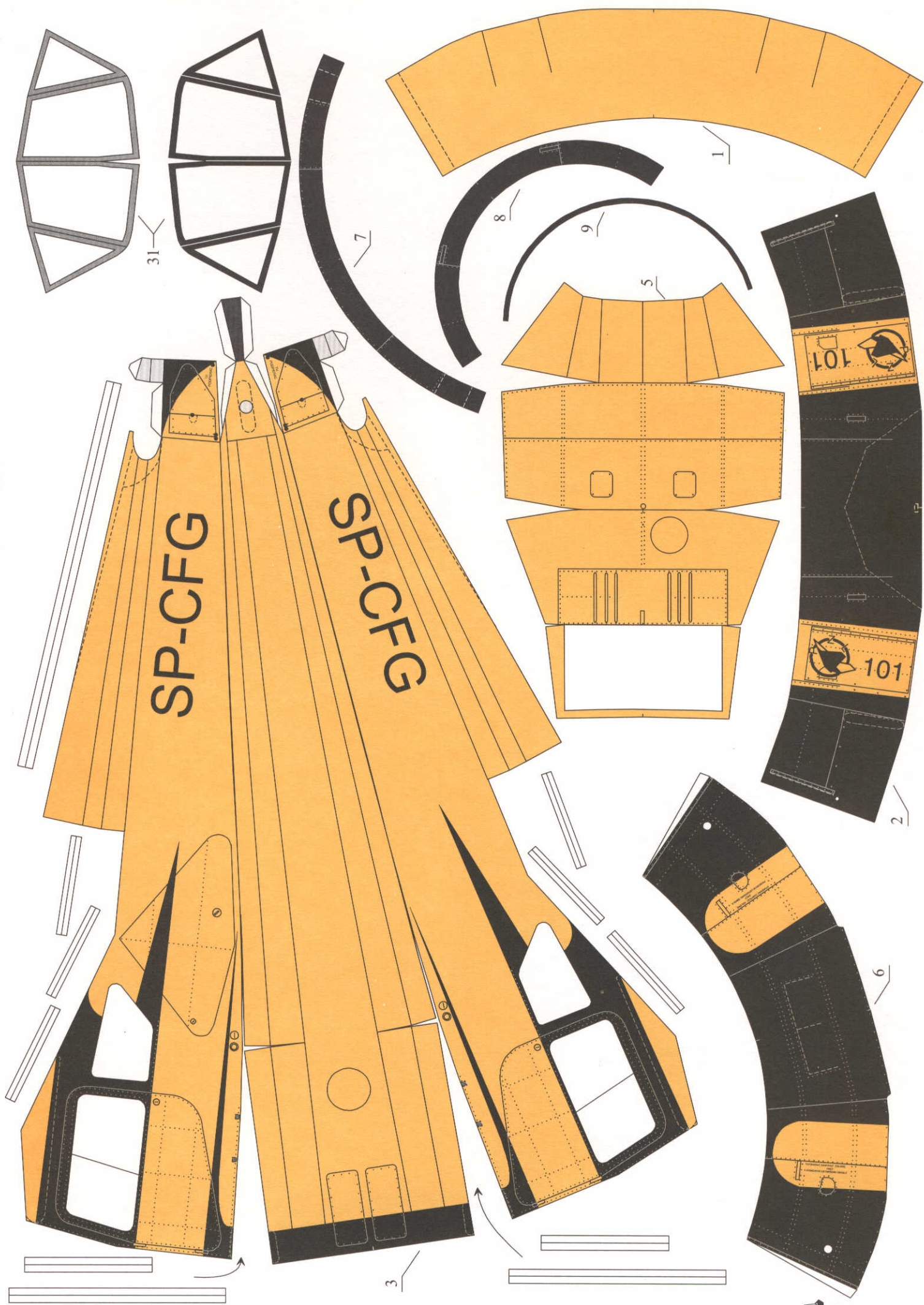

SP-CFG

SP-C-FGG

101

101

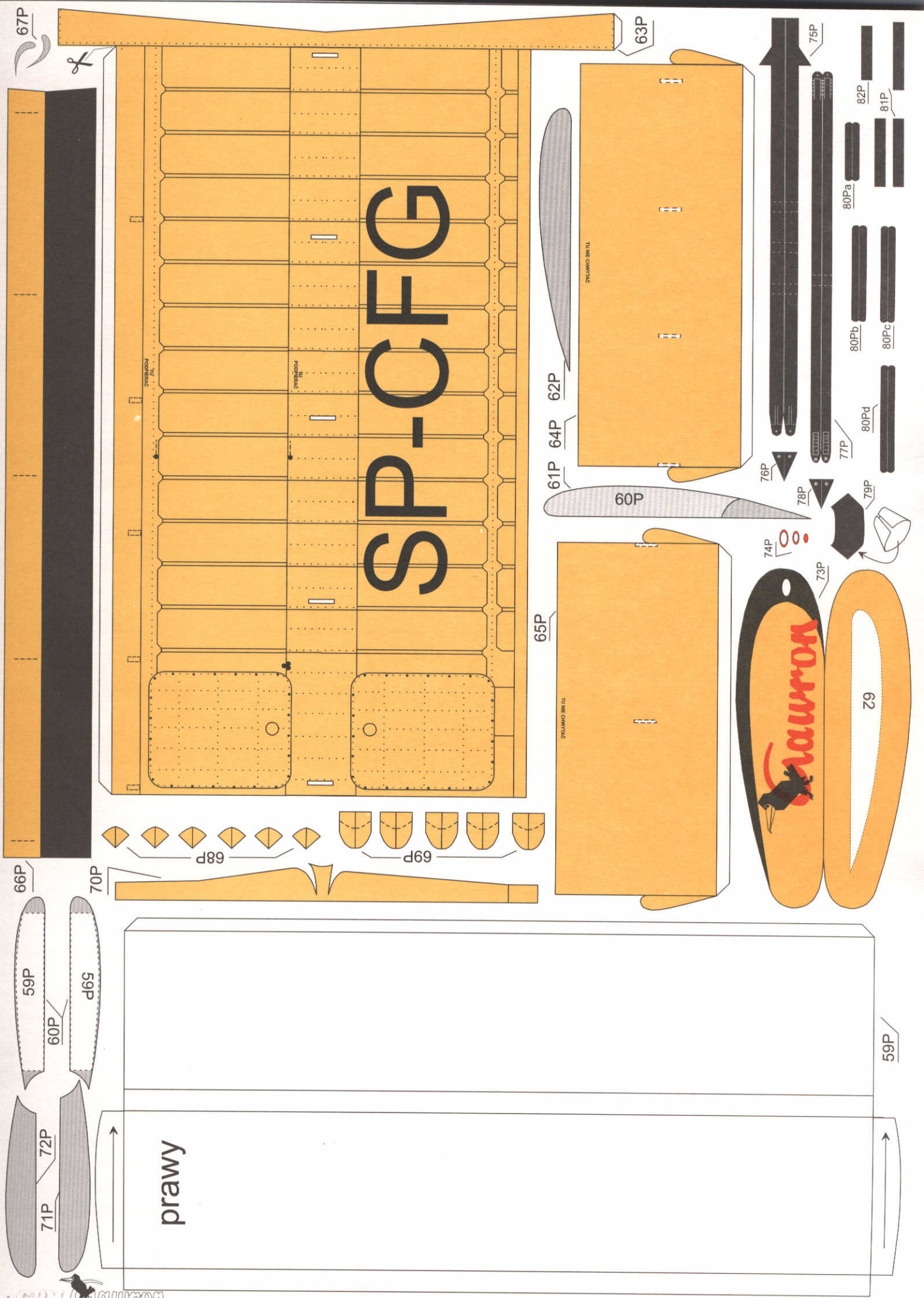

SP-CFG

prawy

SAURON

62

67P

63P

75P

82P

81P

80Pa

80Pb

80Pd

80Pc

61P

64P

62P

60P

65P

74P

73P

78P

79P

76P

77P

66P

70P

68P

69P

59P

59P

60P

71P

72P

59P