

Model kartonowy

1:33

A4 SKYHAWK

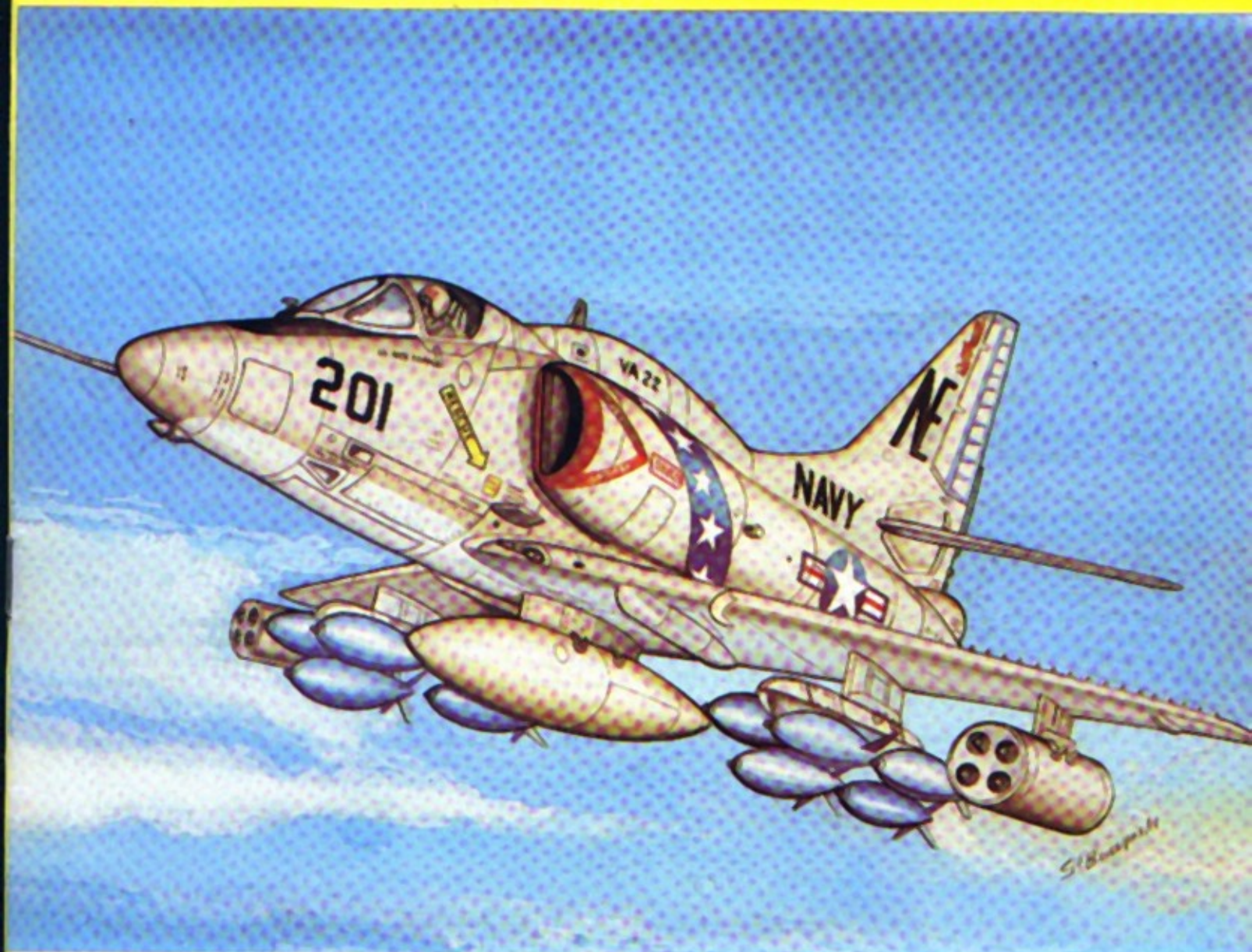

GPM

Nr 38

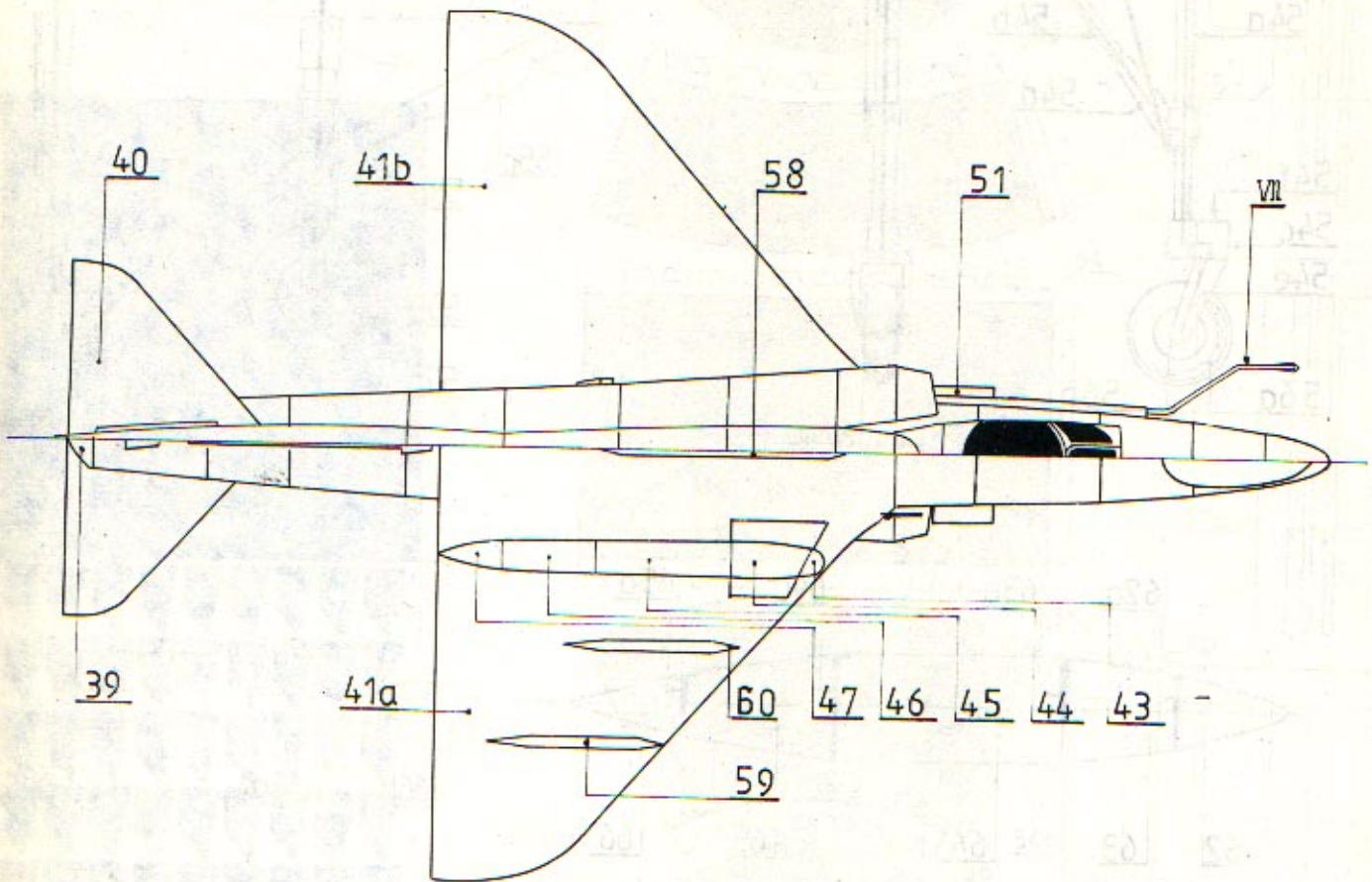
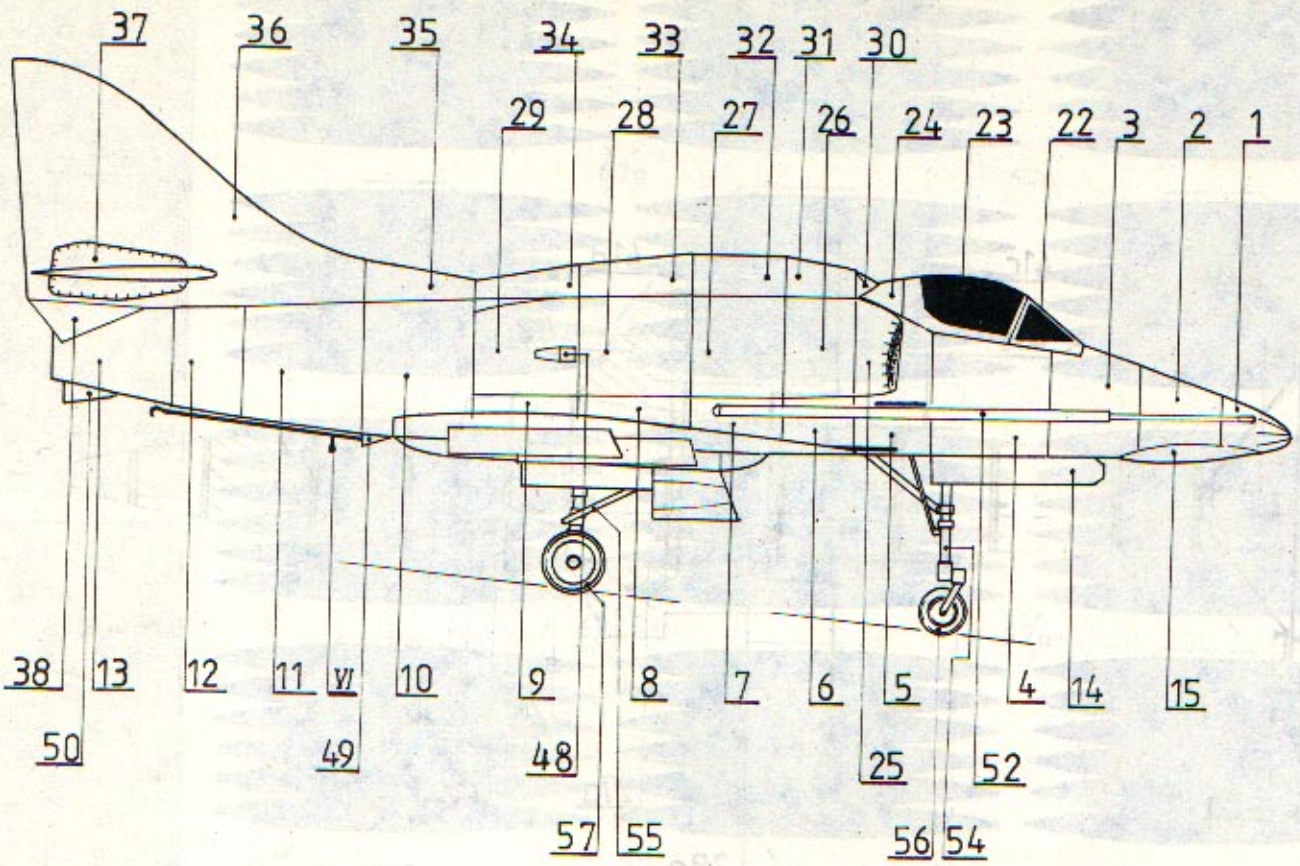

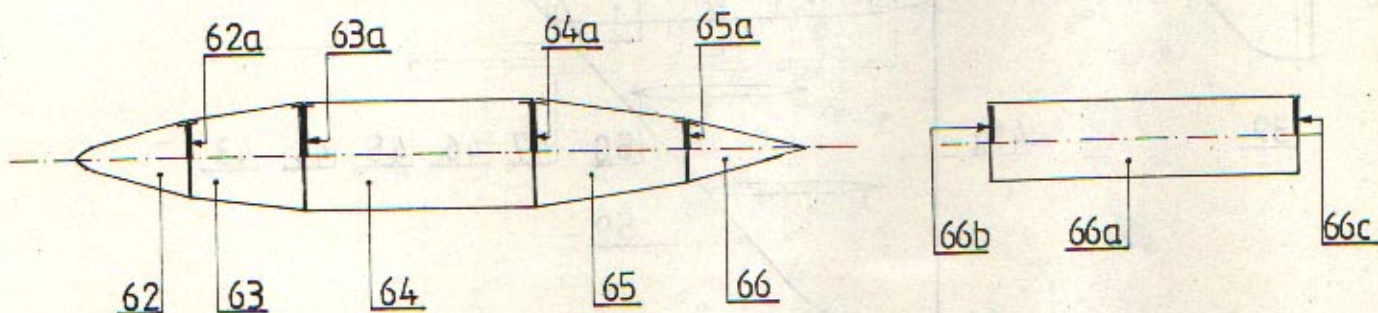
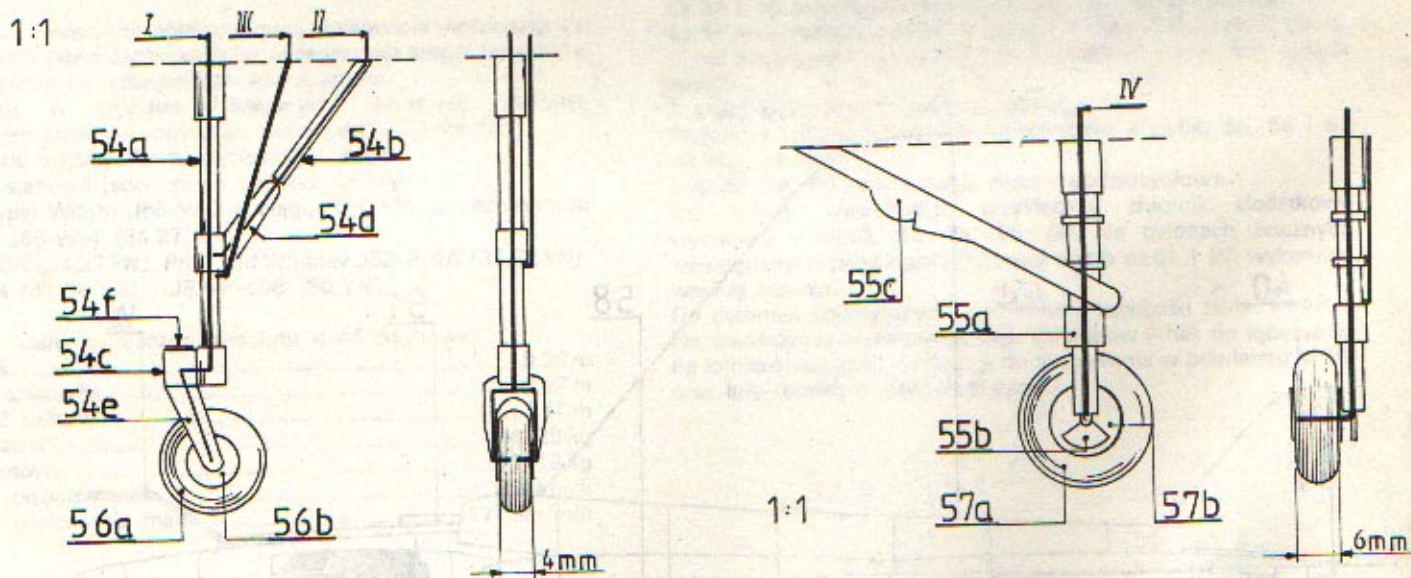
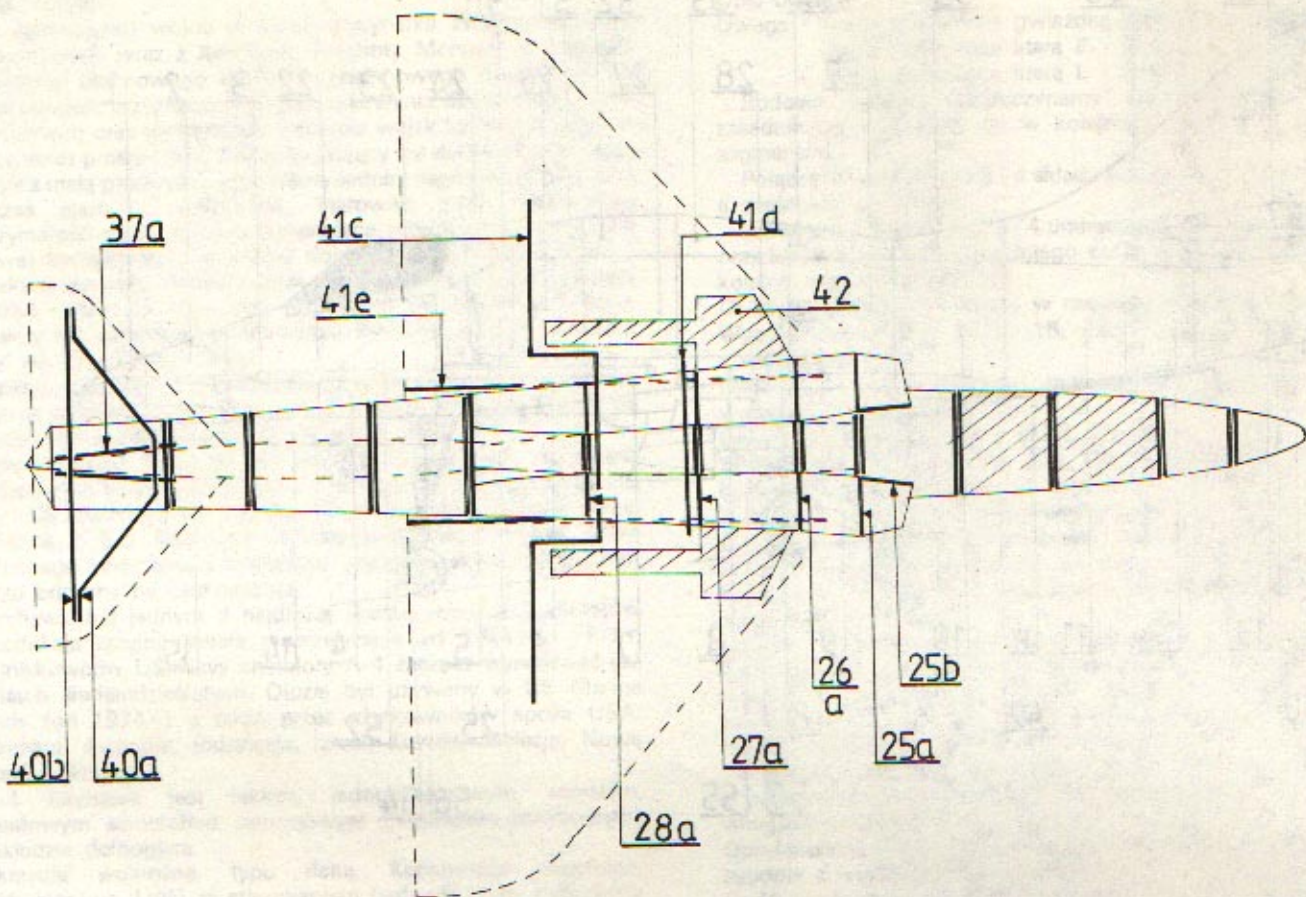

ZBIORNIK

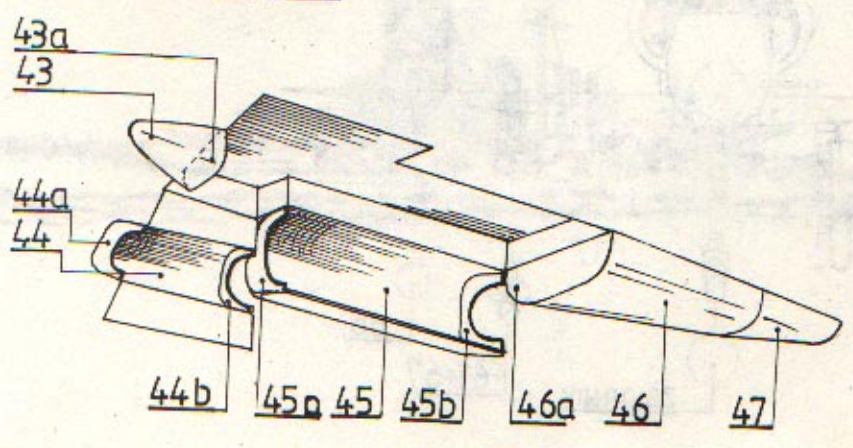
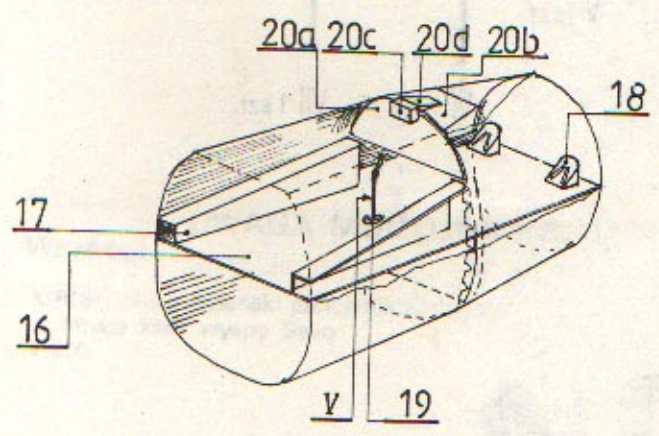
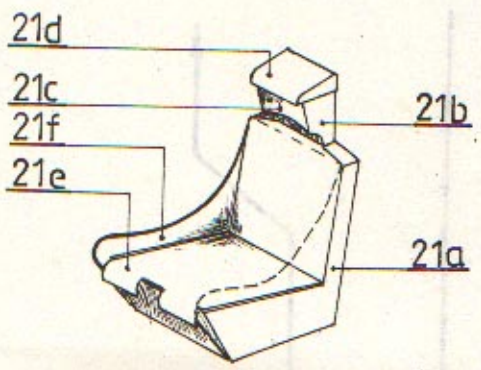
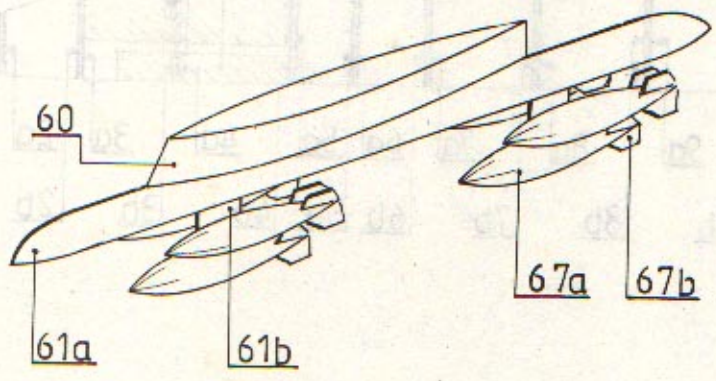

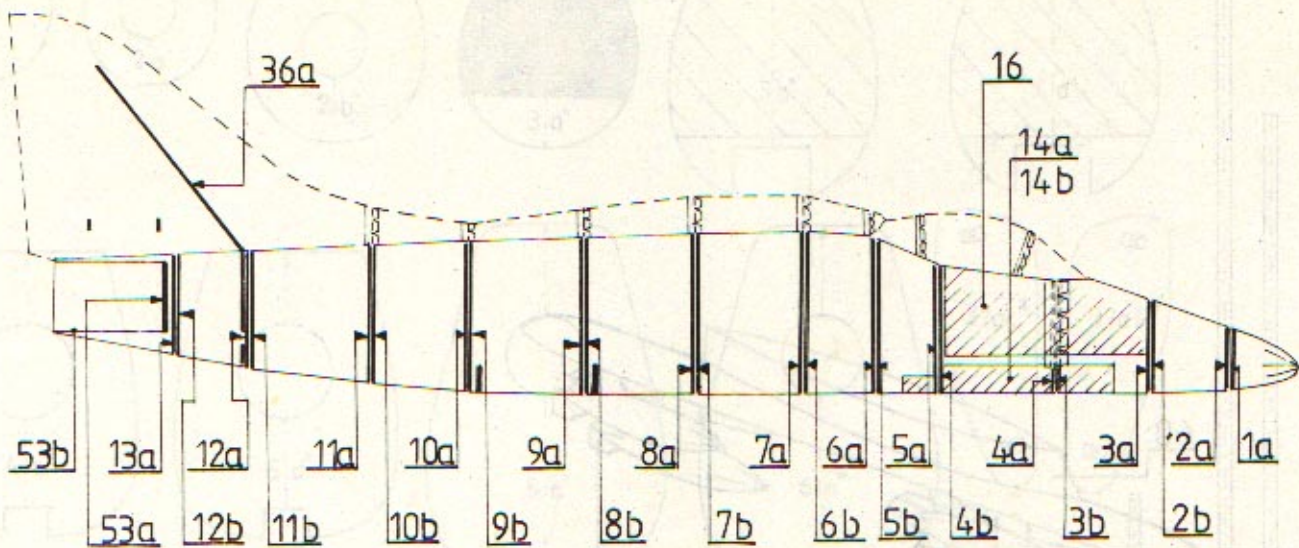

SZABLONY

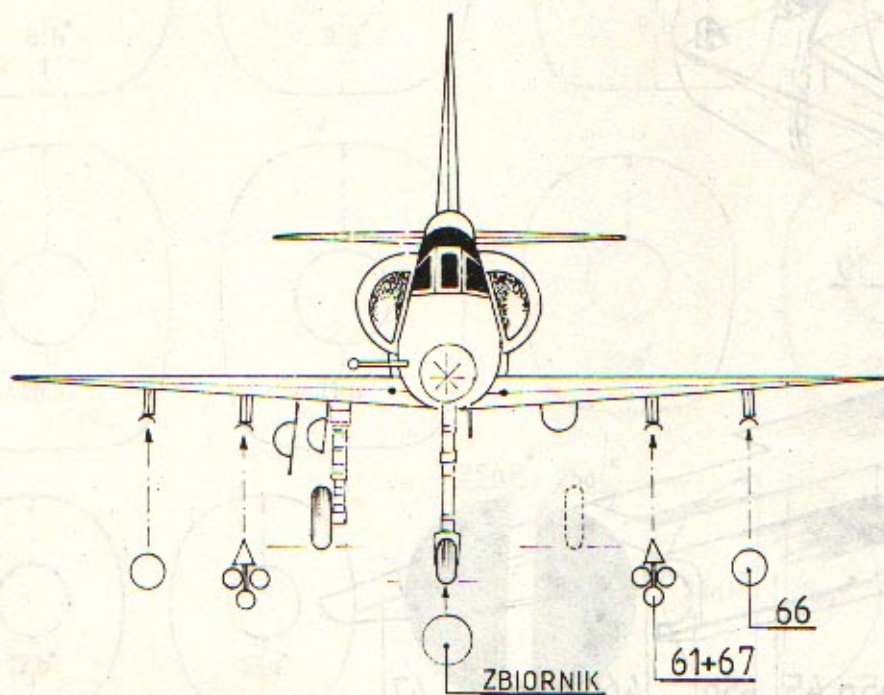
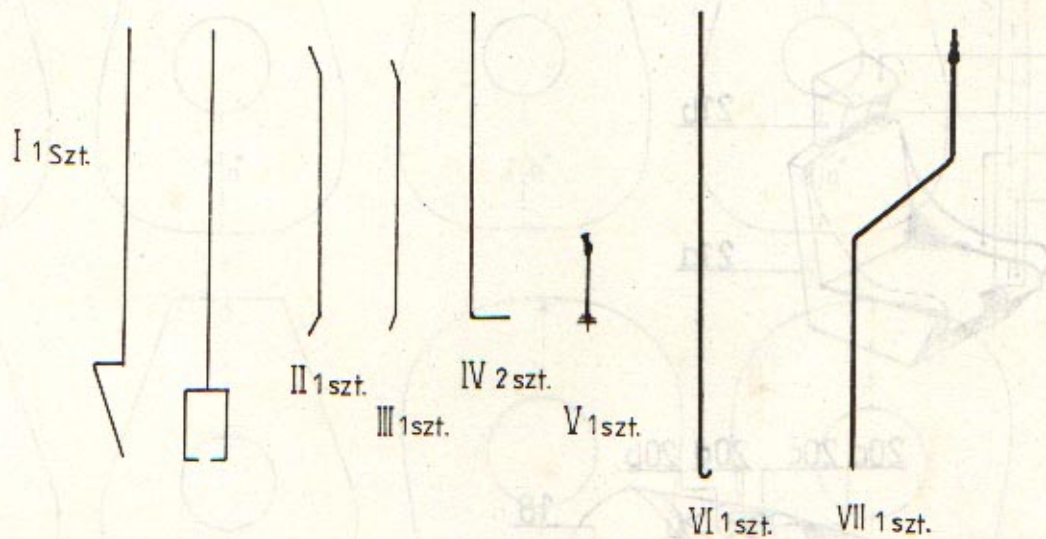

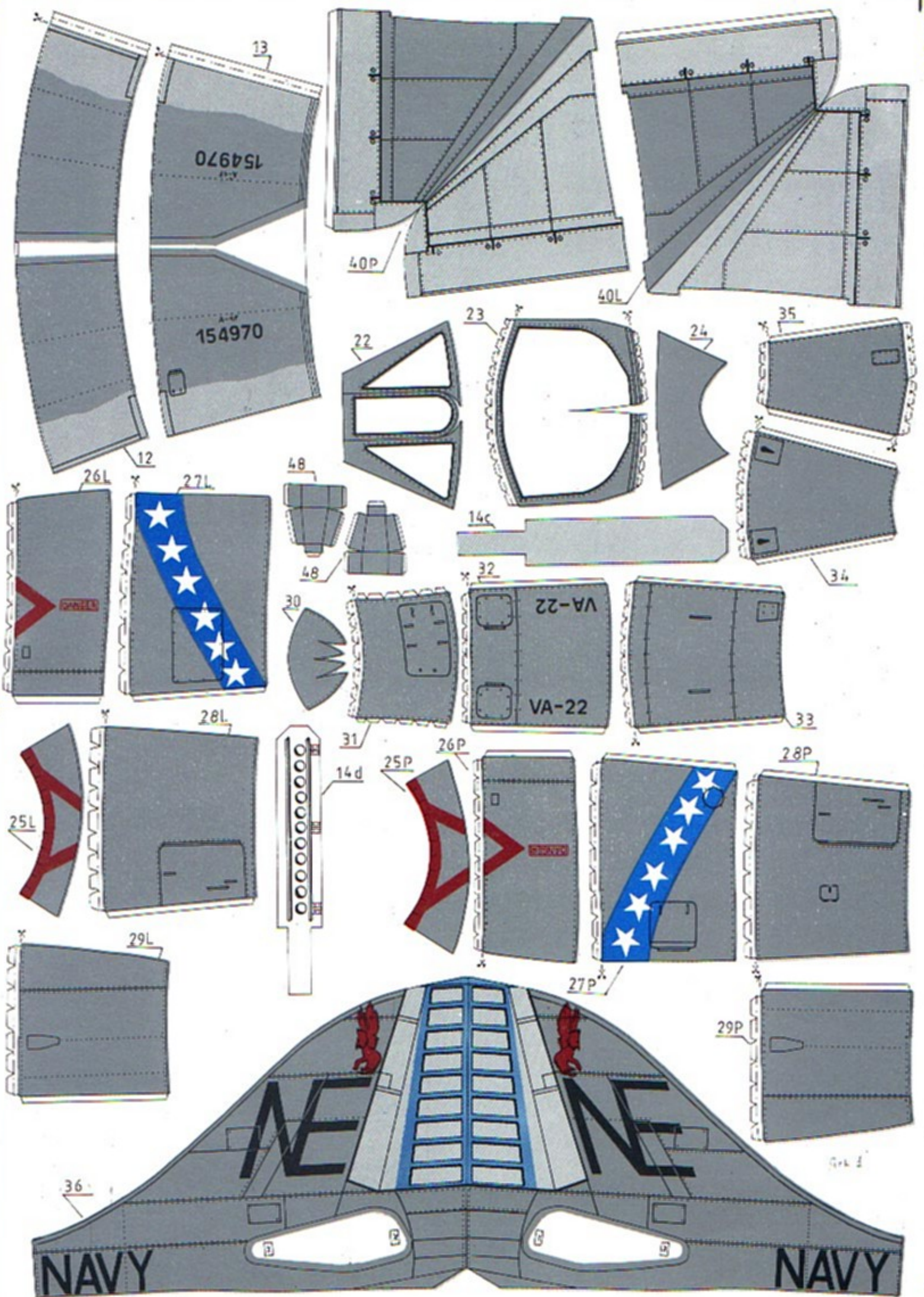

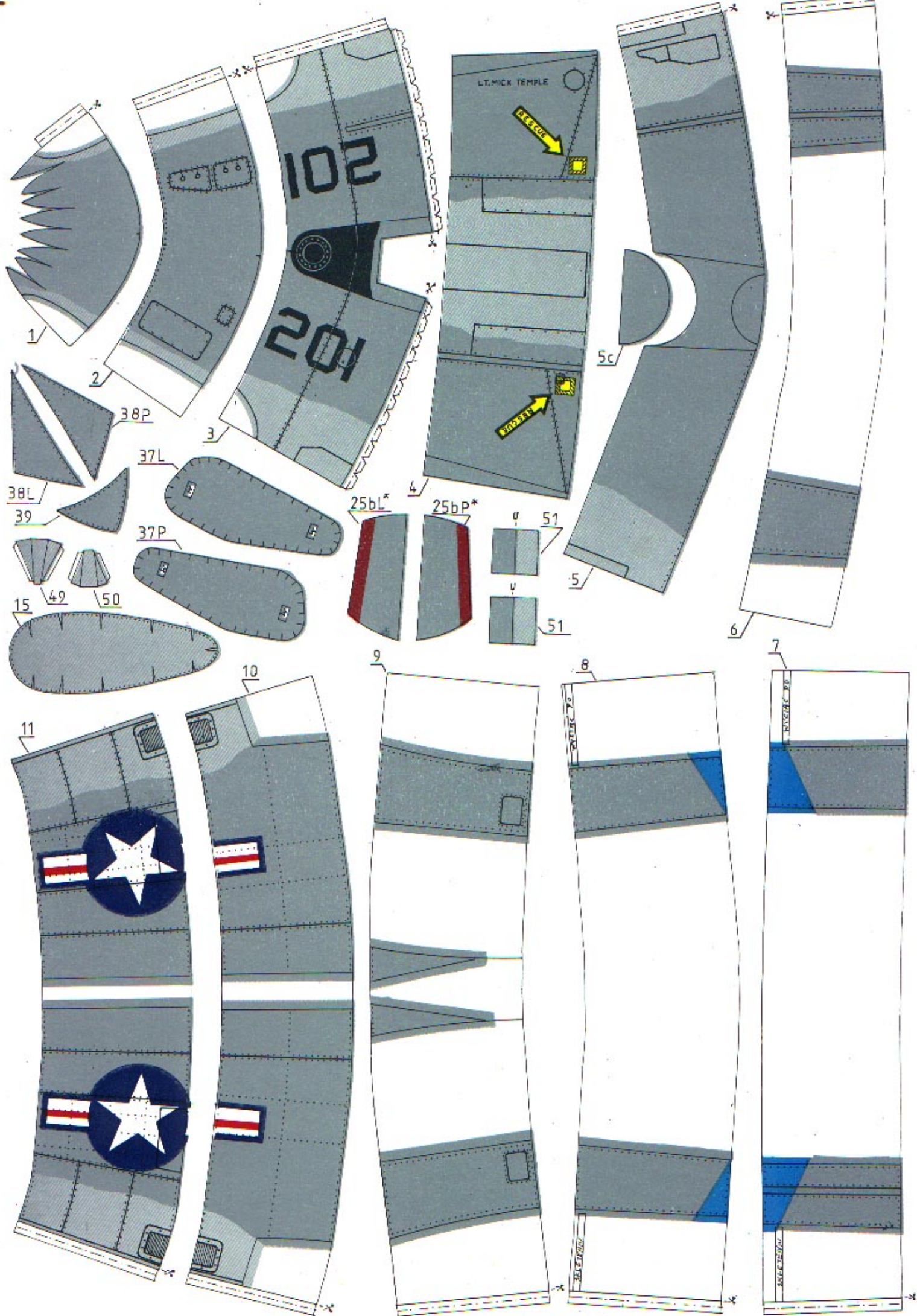

1

2

3

4

5

6

9

8

7

11

10

38L

38P

37L

37P

39

15

49

50

25bL*

25bP*

51

51

u

v

LT. MICK TEMPLE

RESERVE

5c

INVERTED

INVERTED

INVERTED

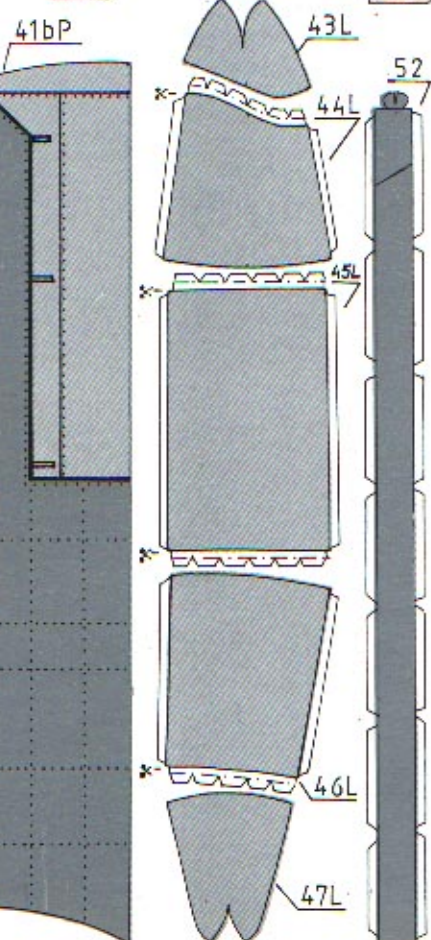
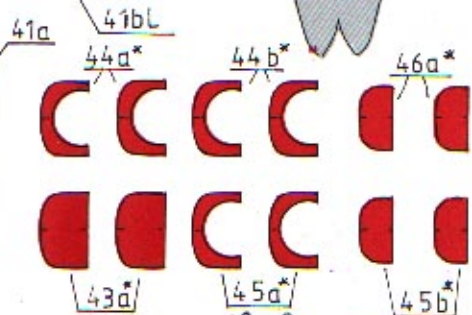
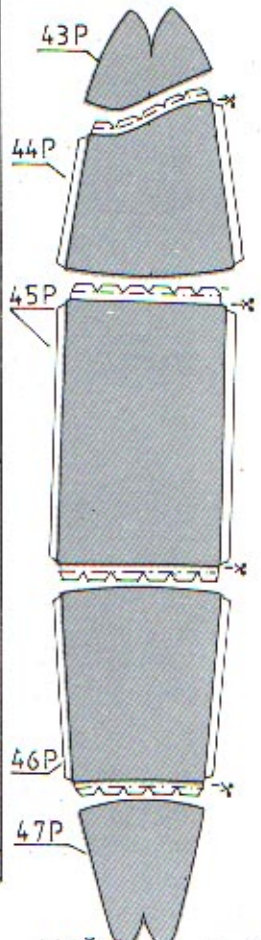
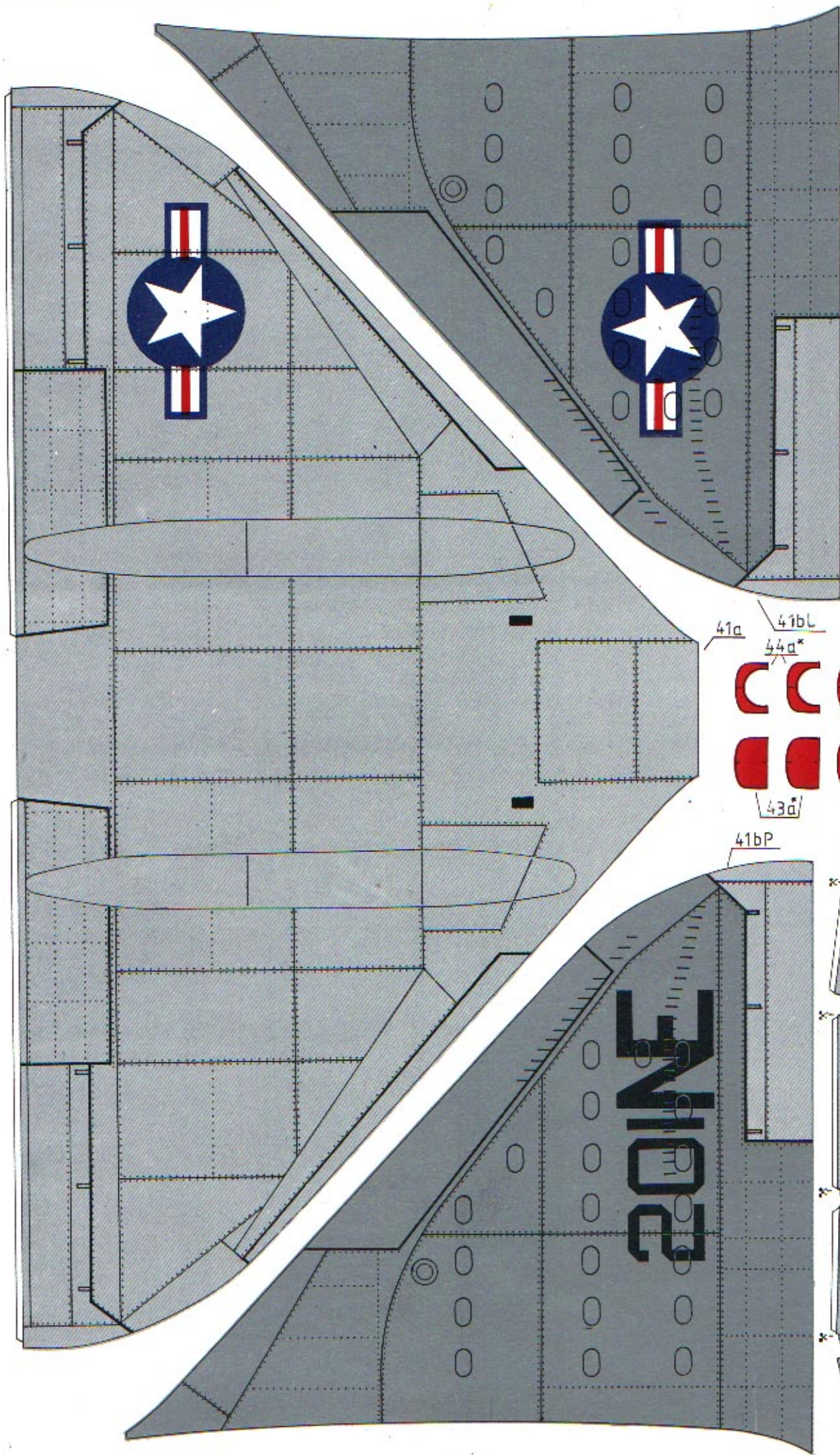

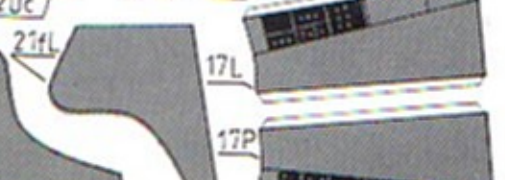
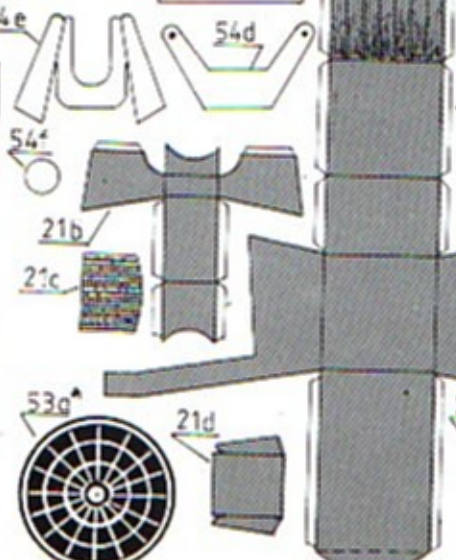
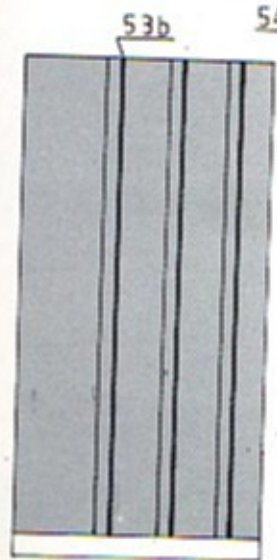
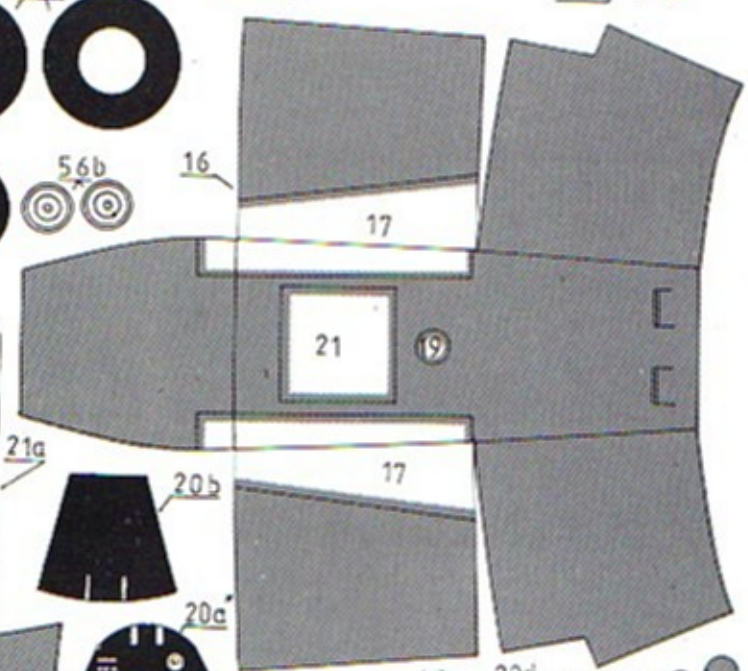
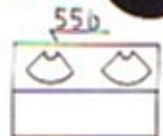
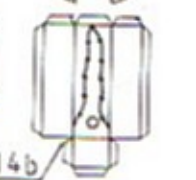
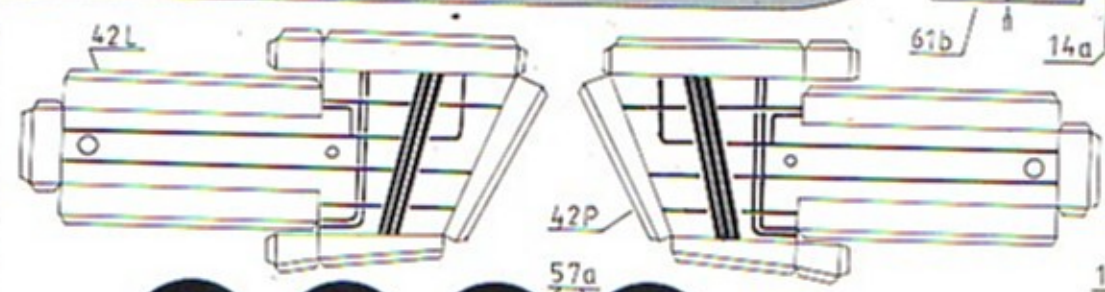
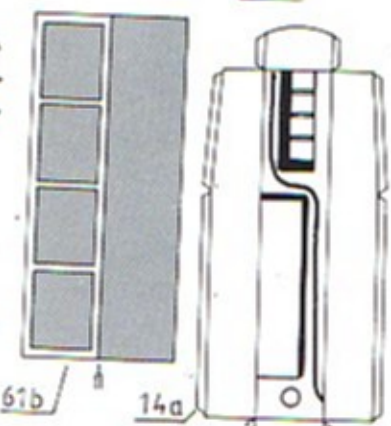
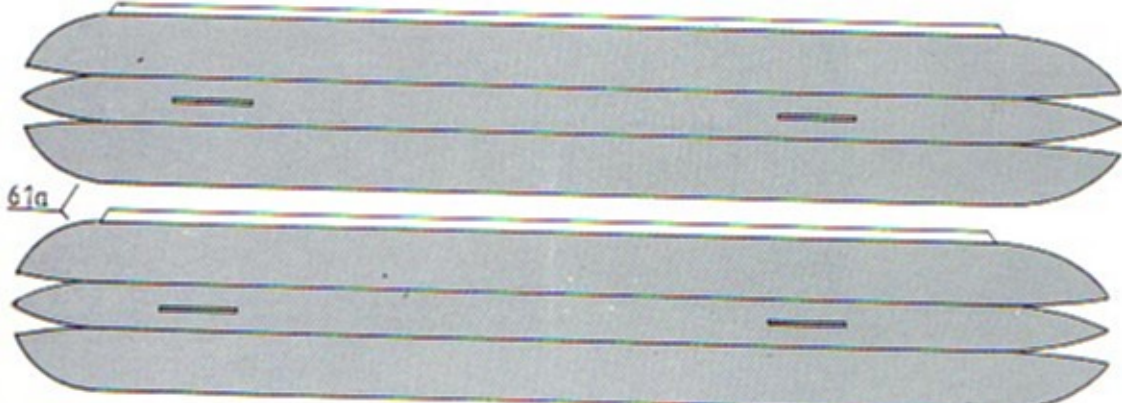
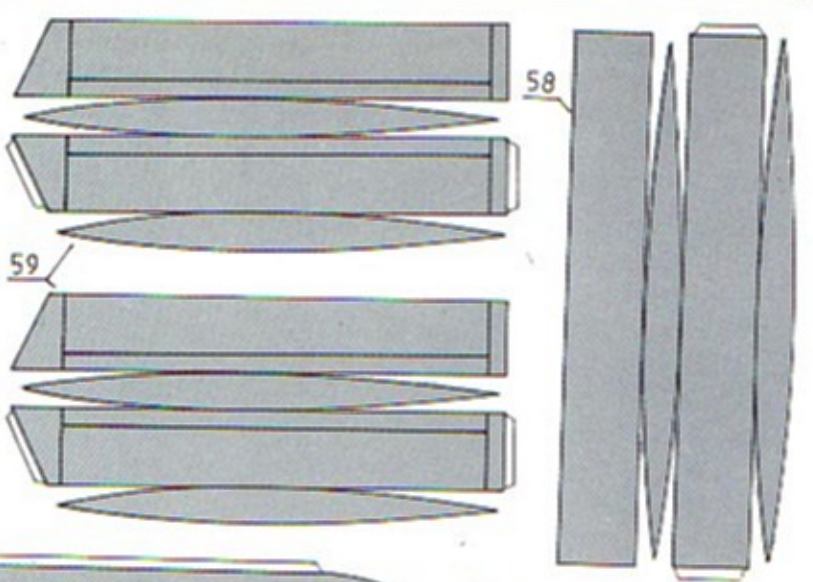
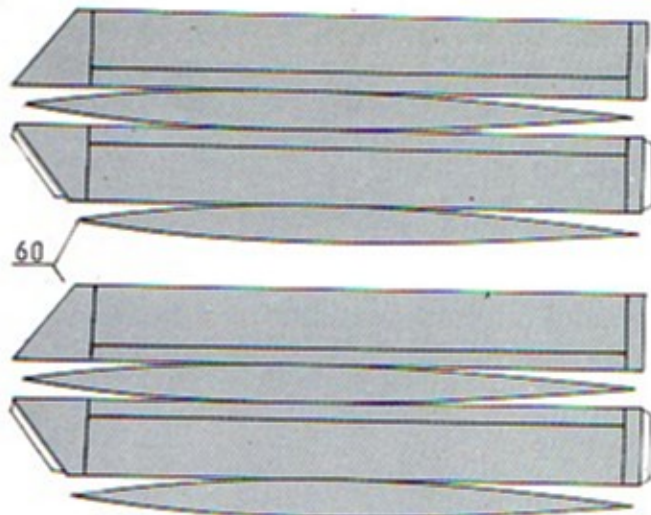

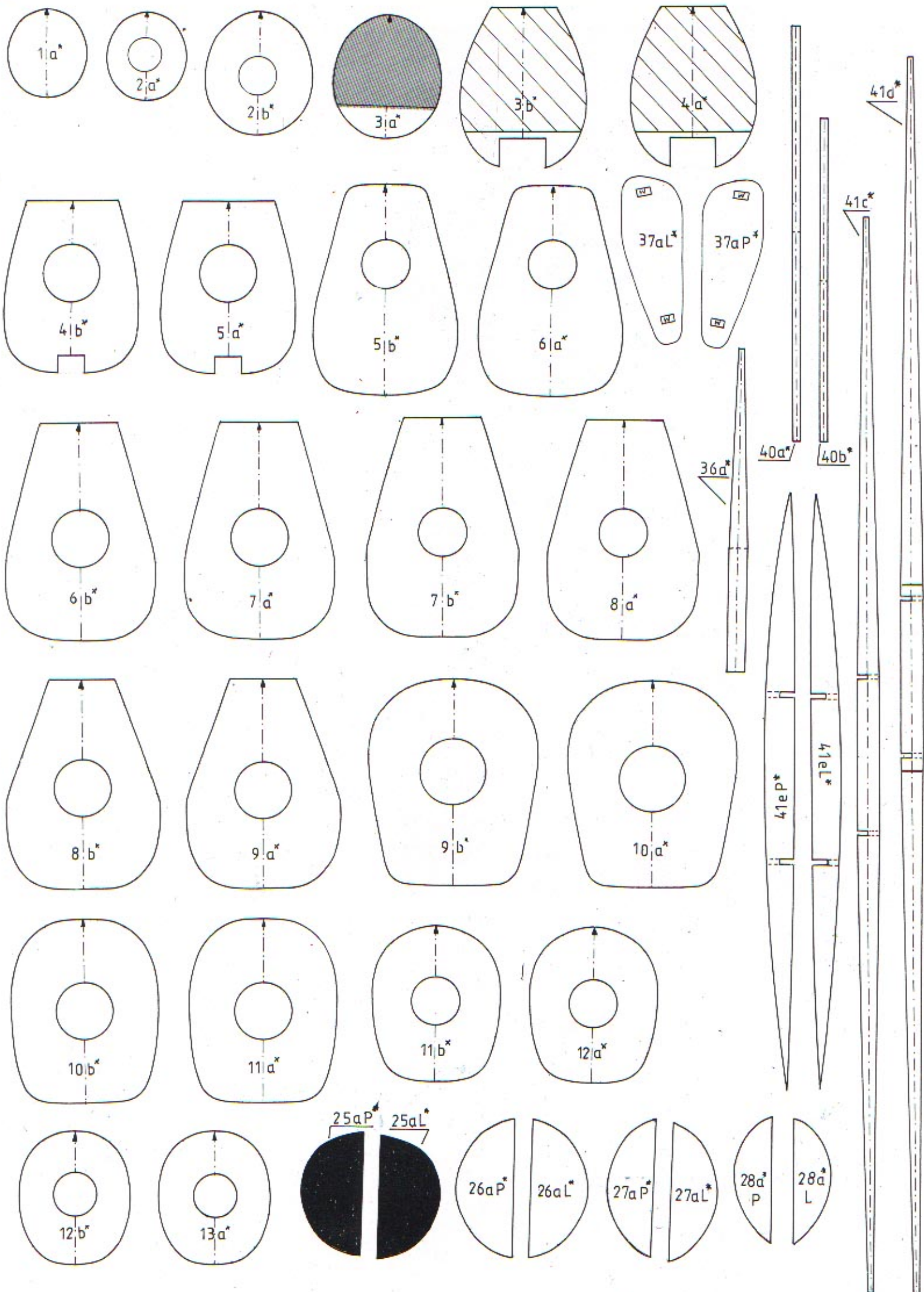

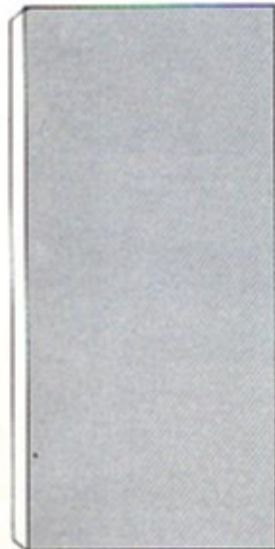
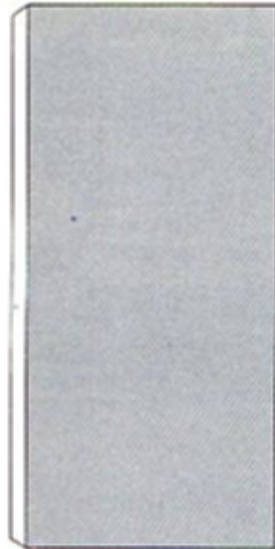

66a

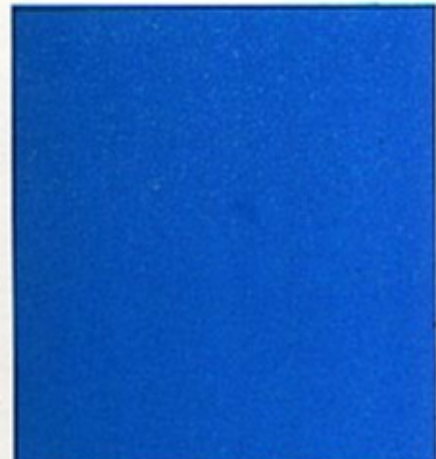
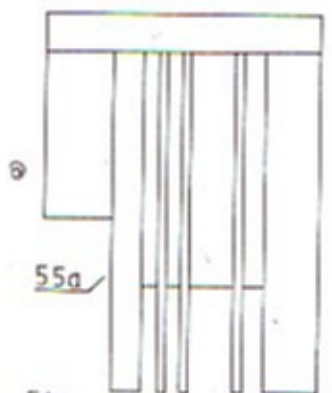
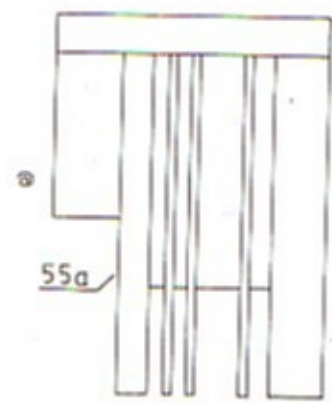
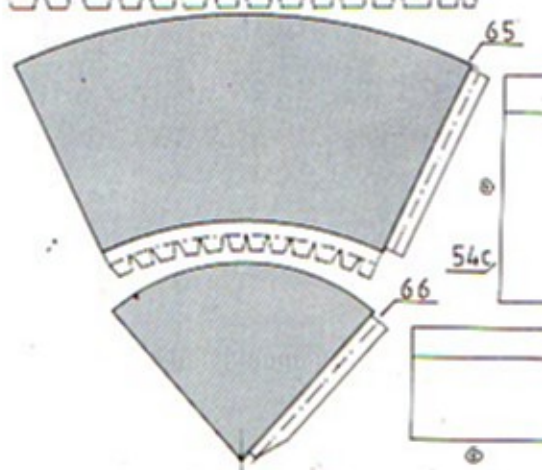
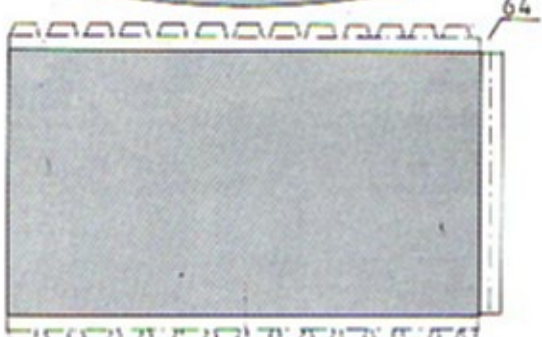
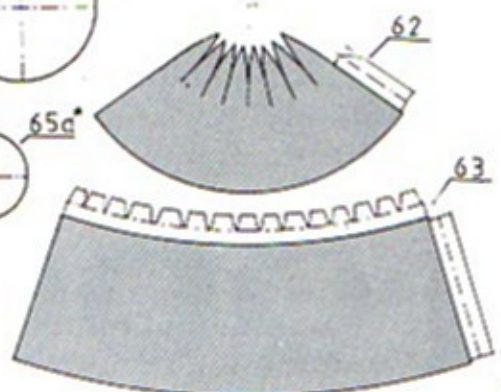
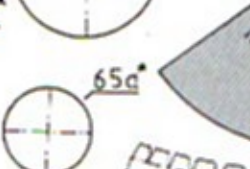
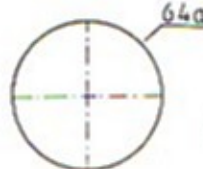
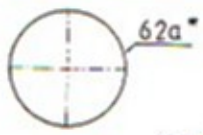
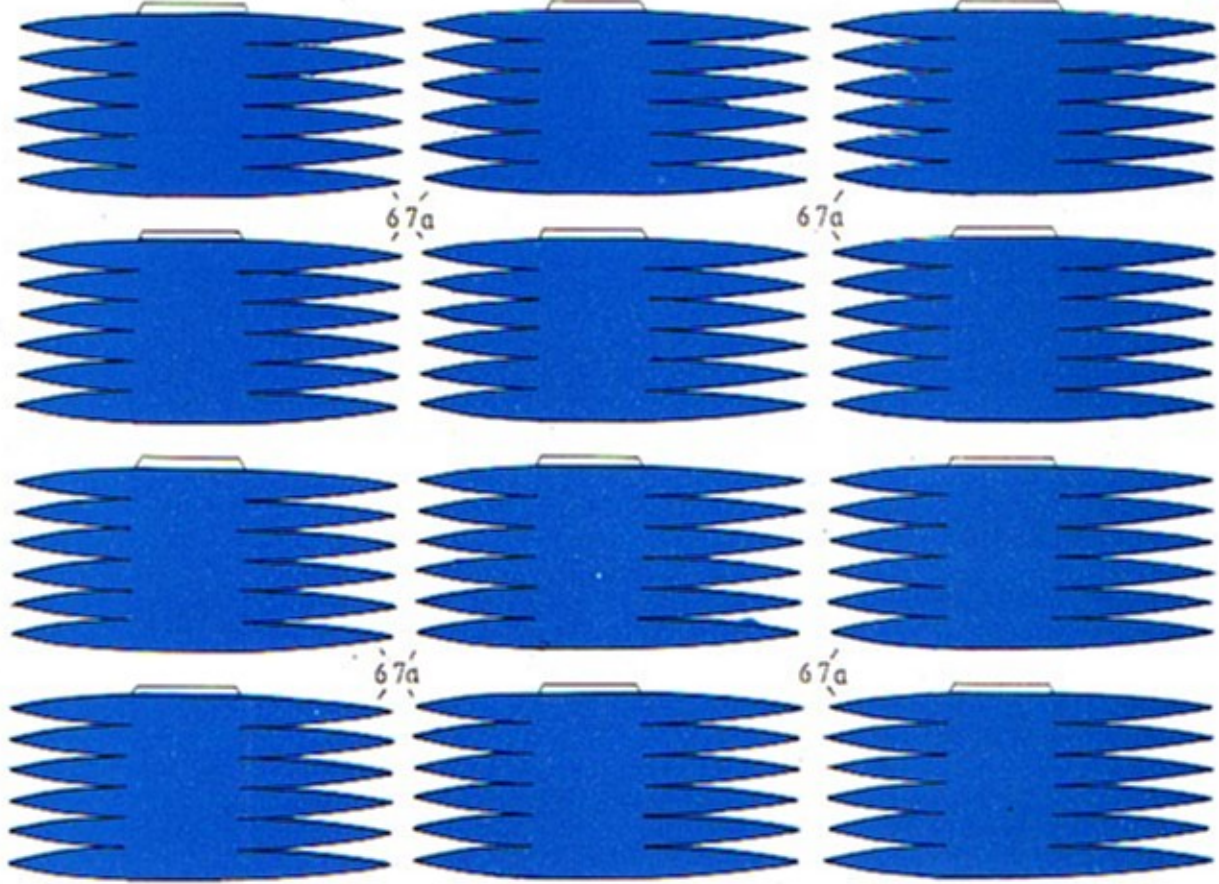

67b

