

1:33

MODEL KARTONOWY

GPM

NR

37

Mitsubishi

BETTY & OHKA

ISBN 83-86163-23-2

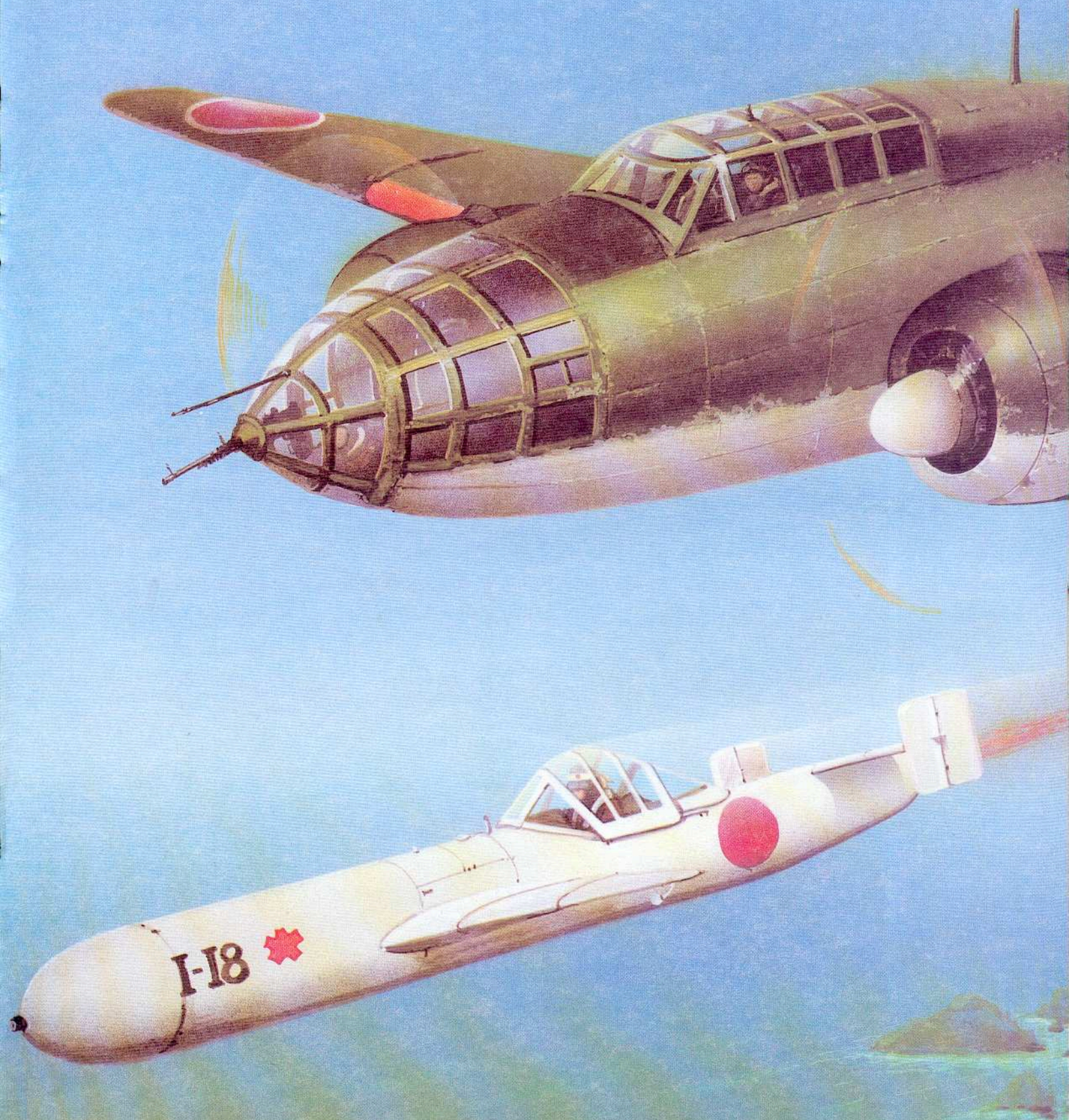

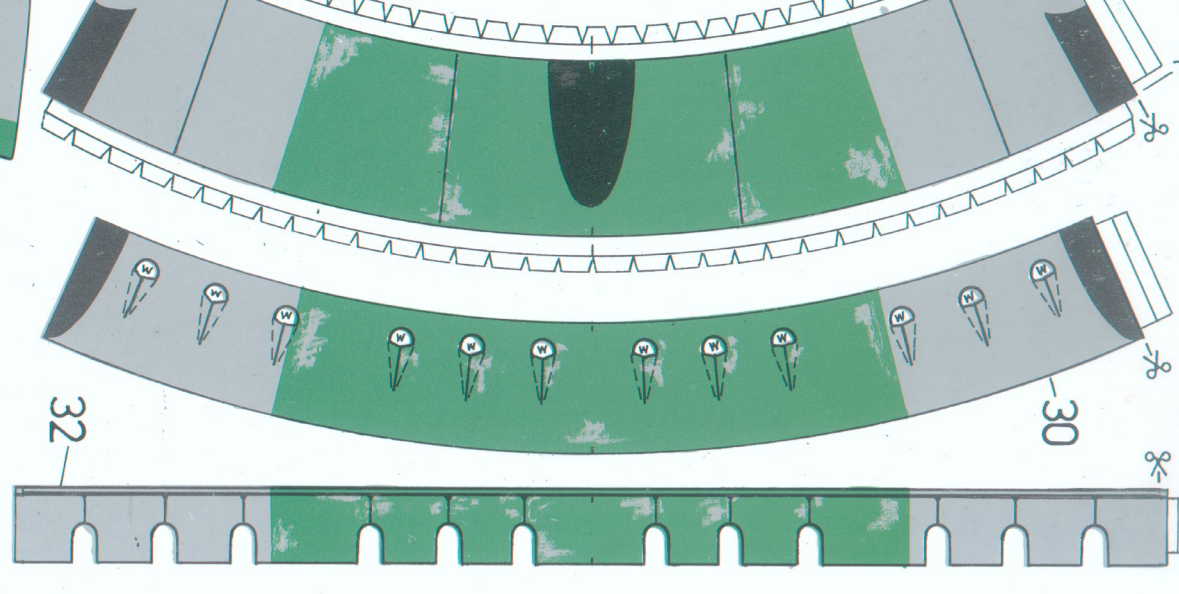
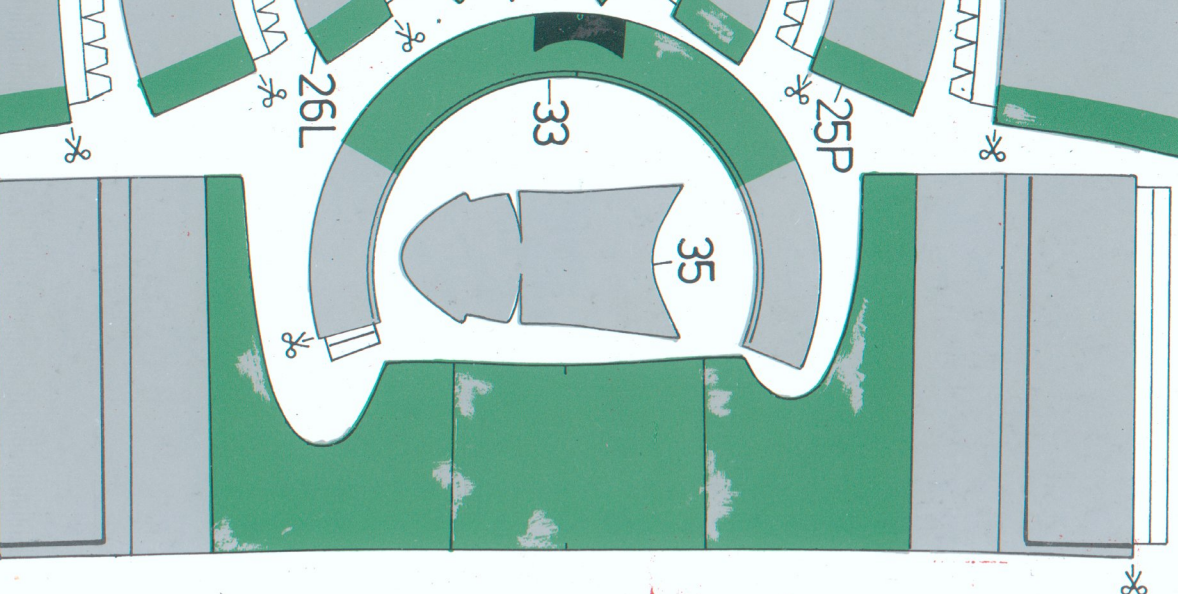
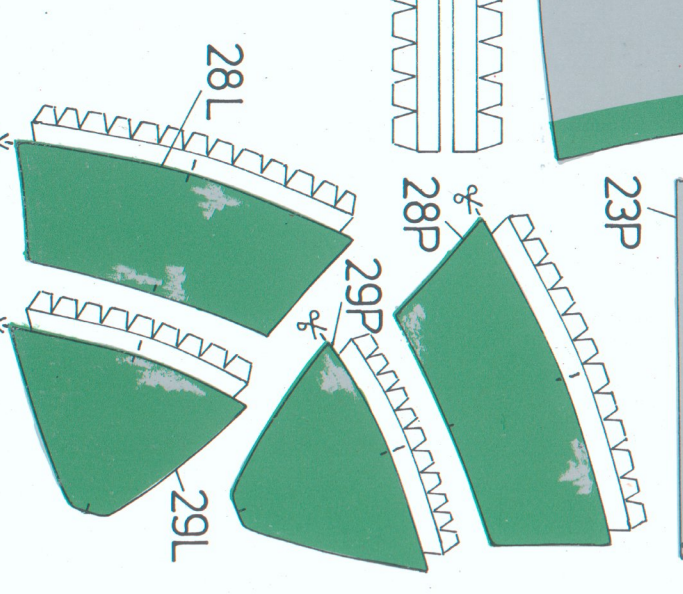
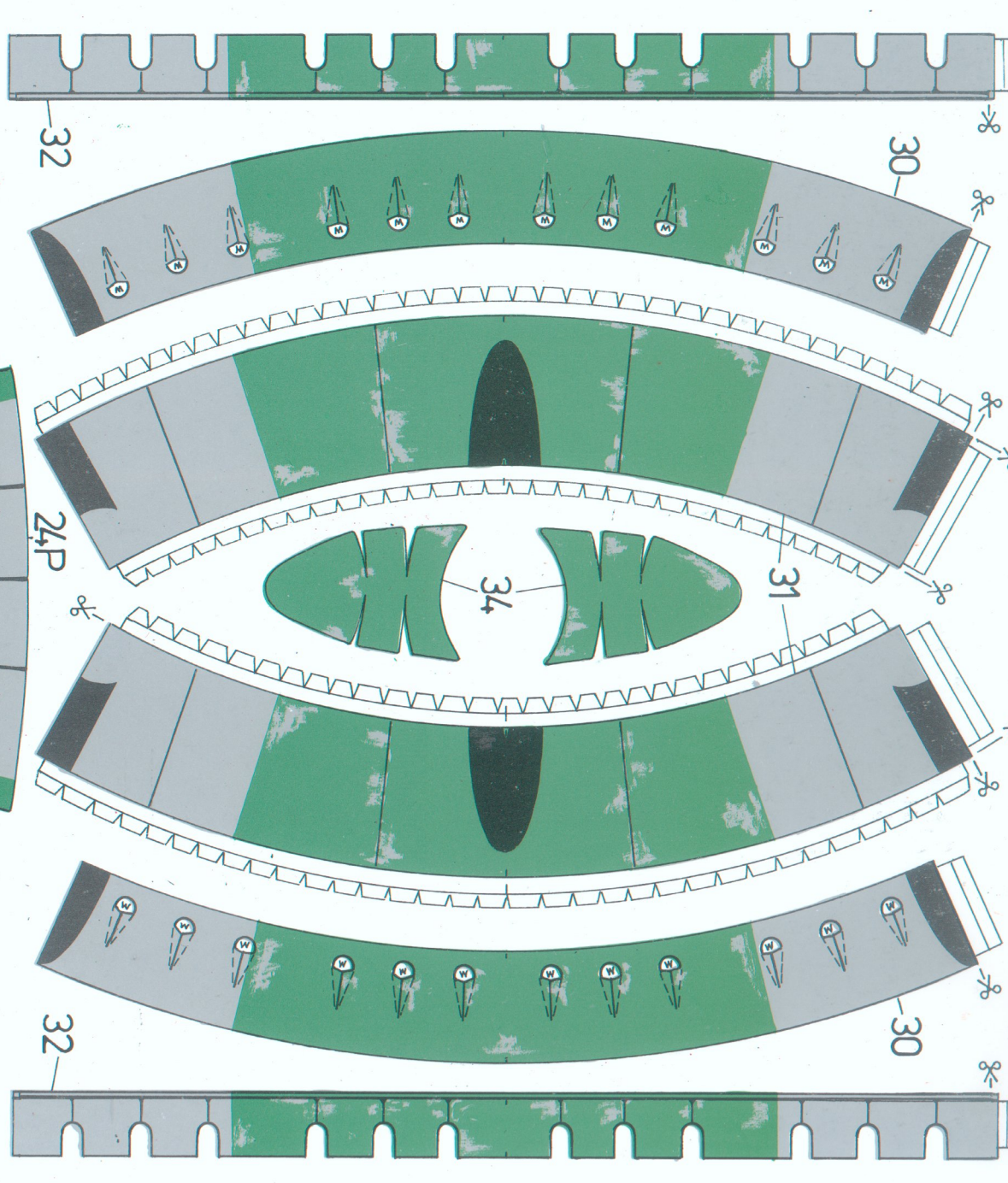
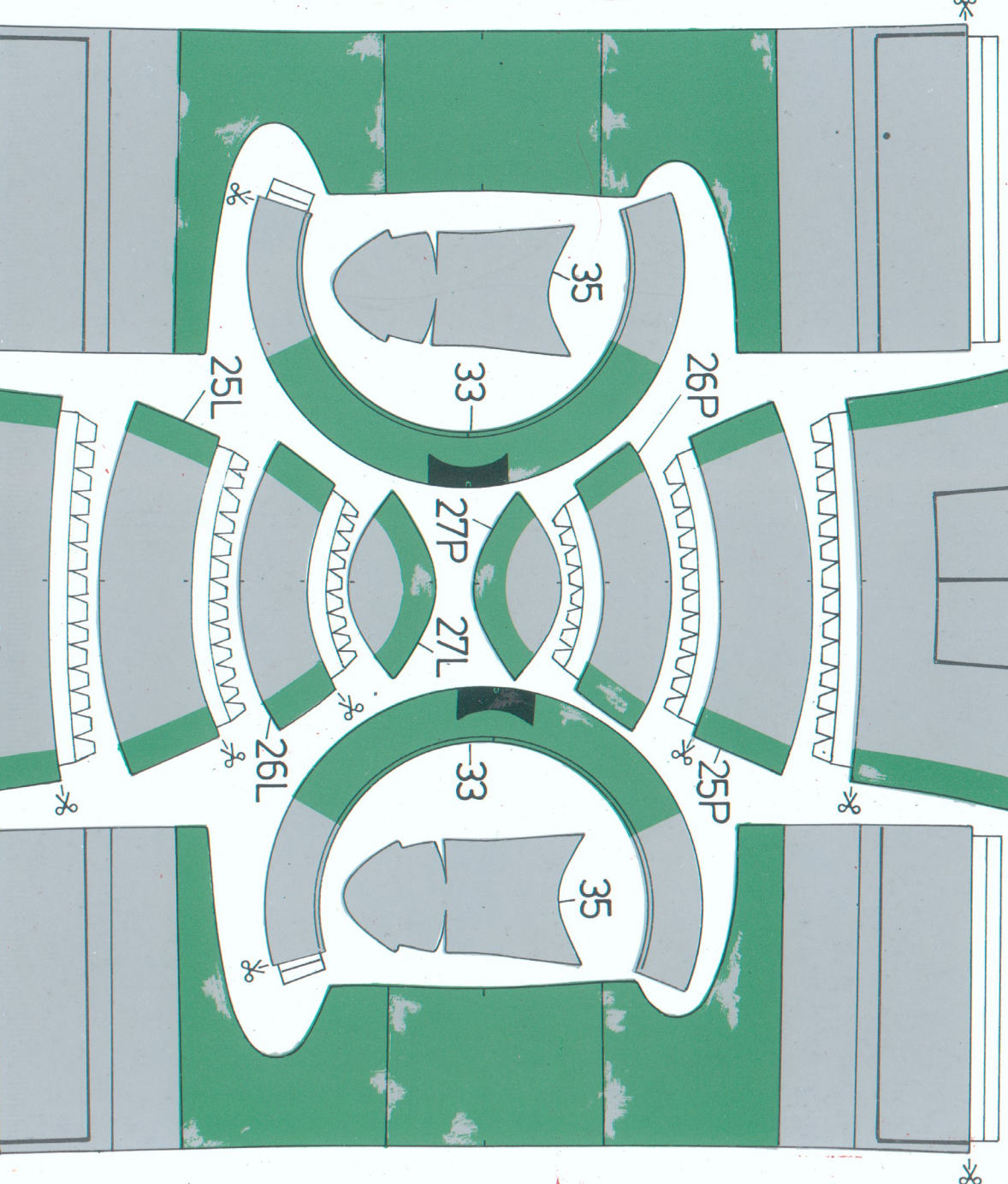
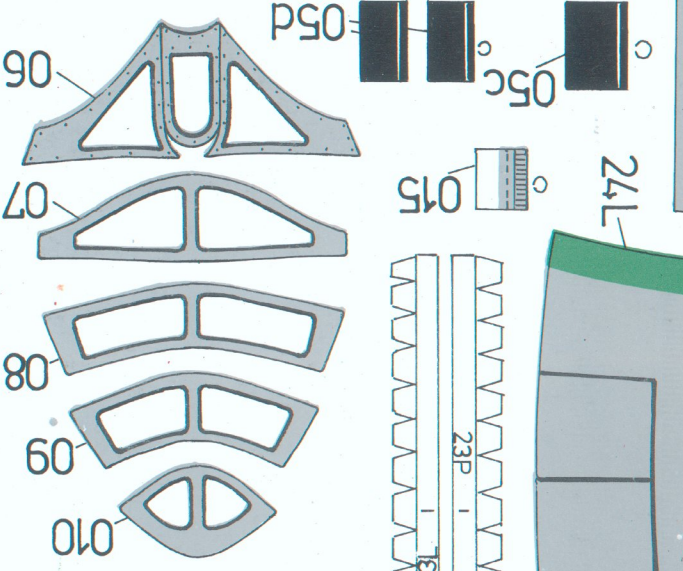
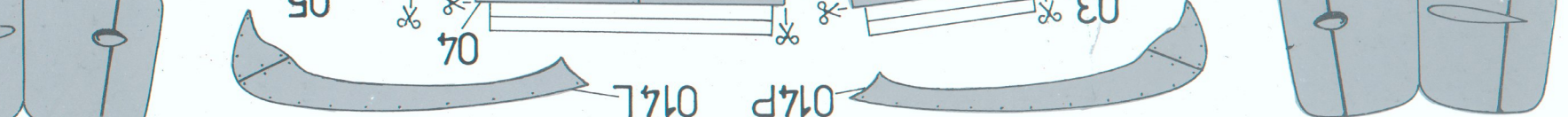
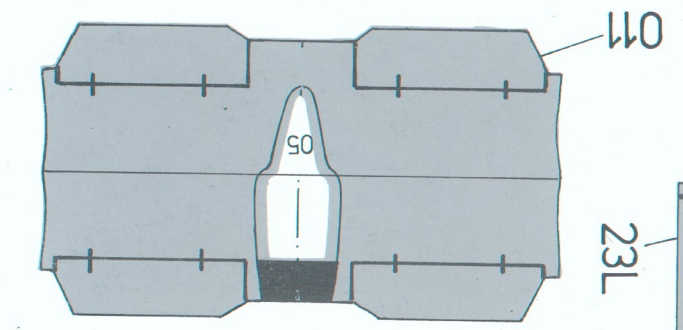
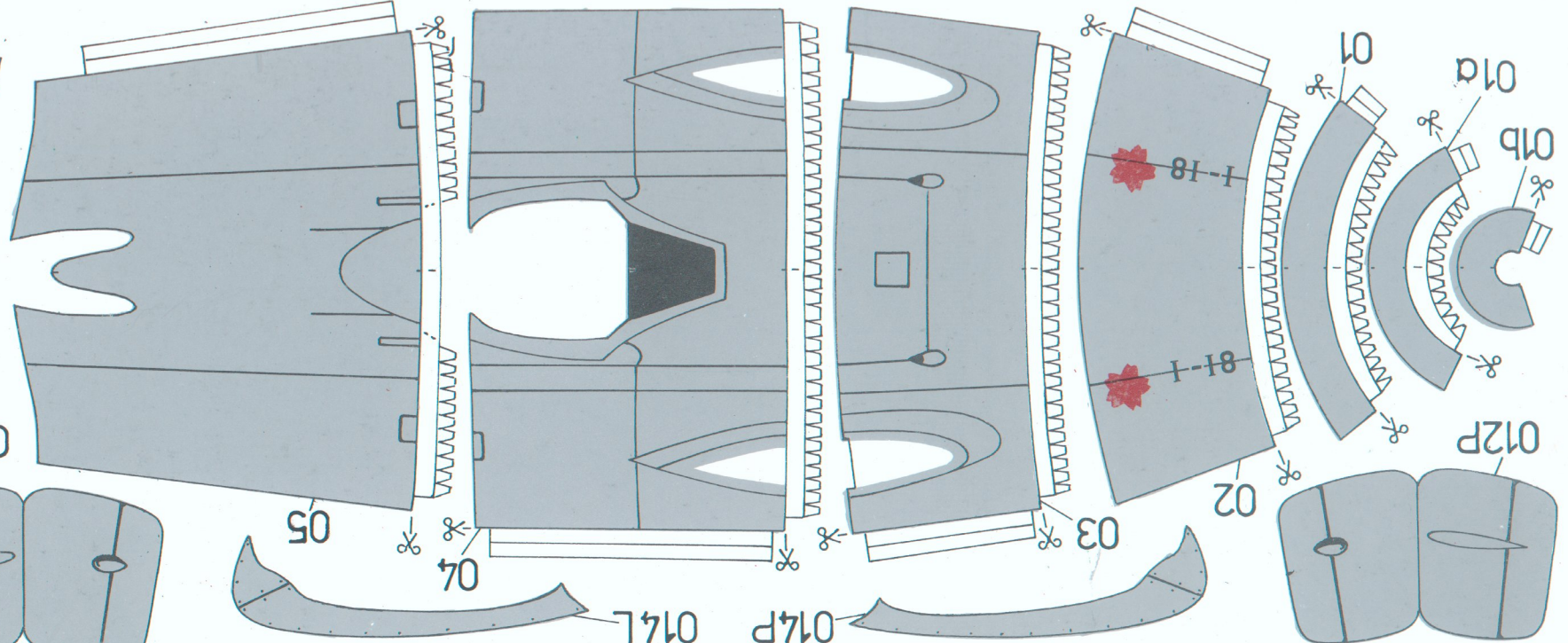
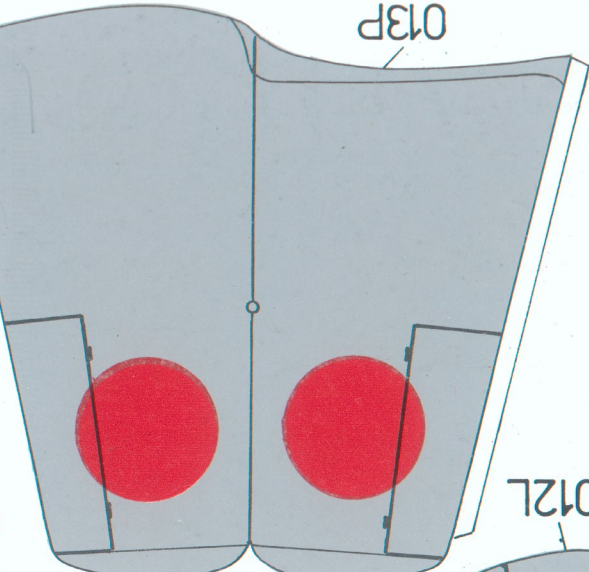
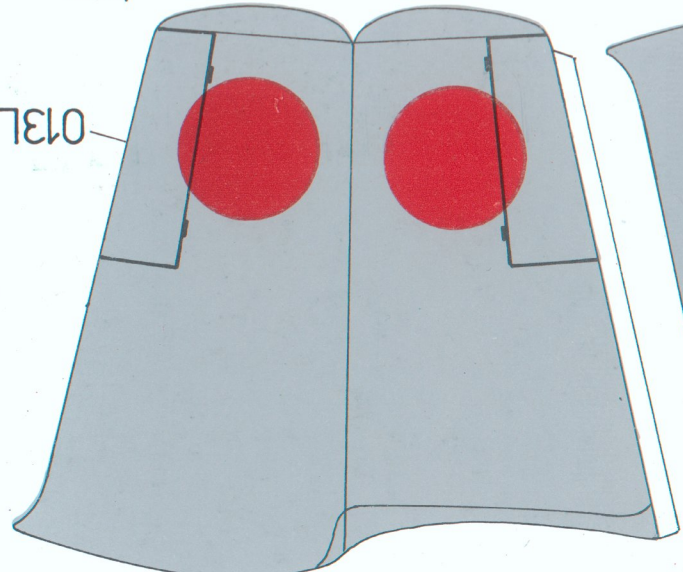
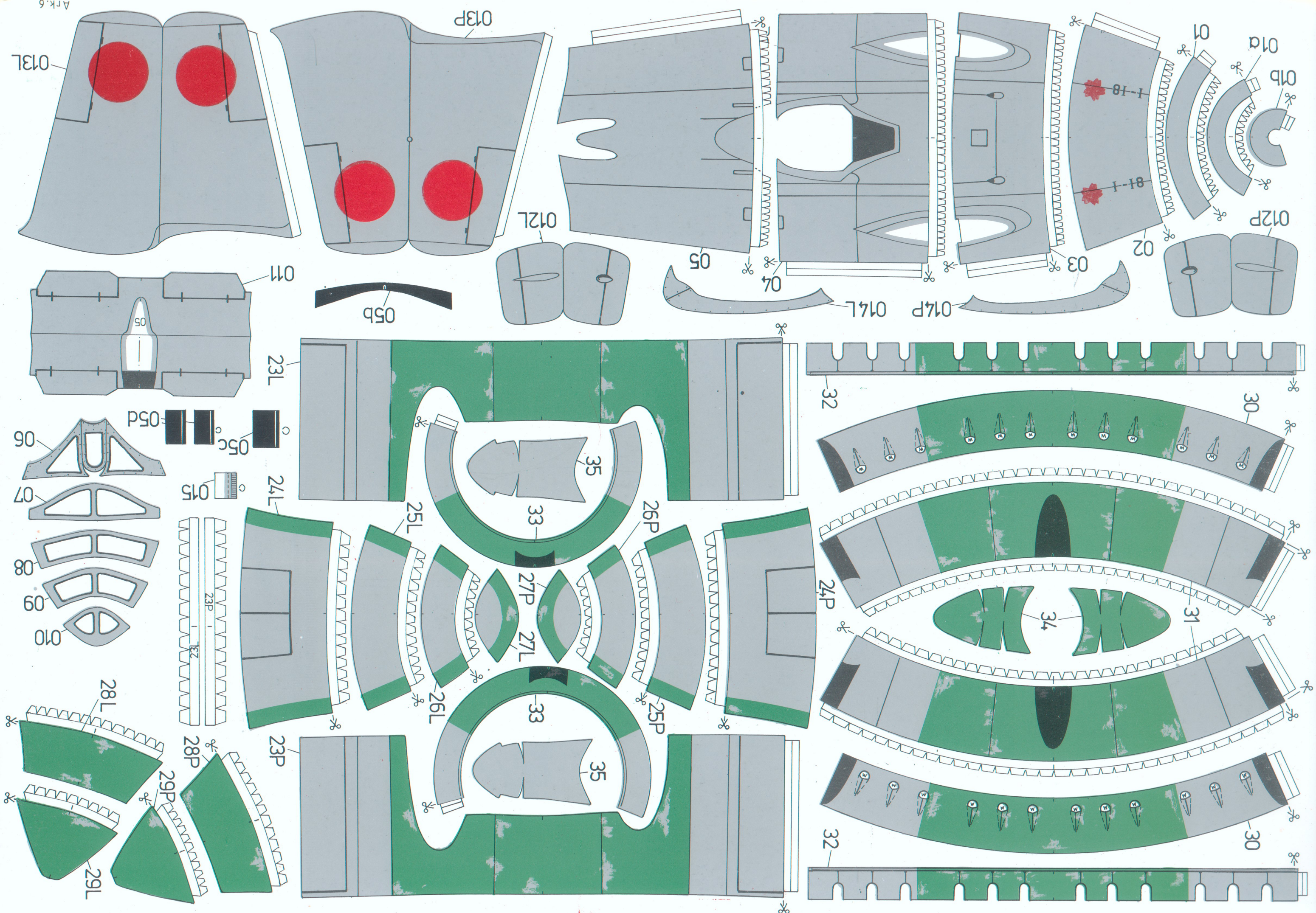

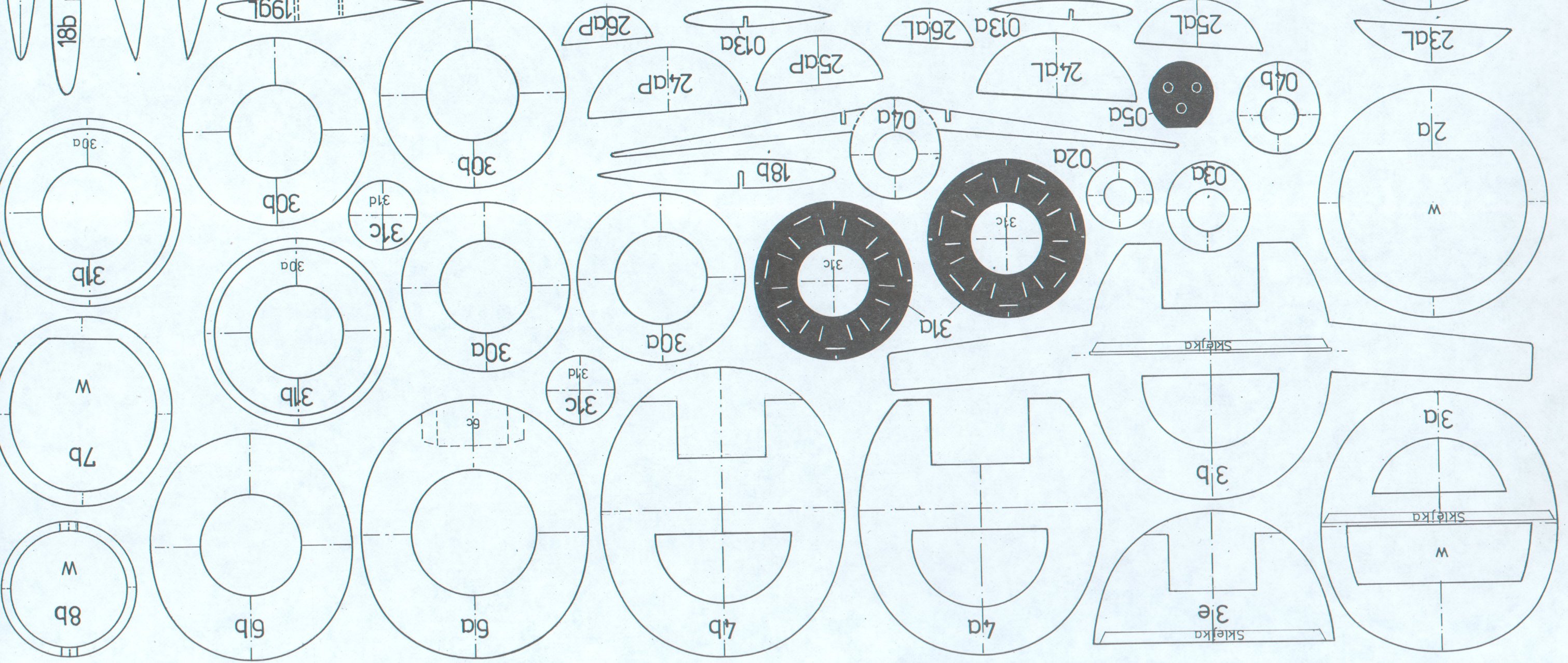
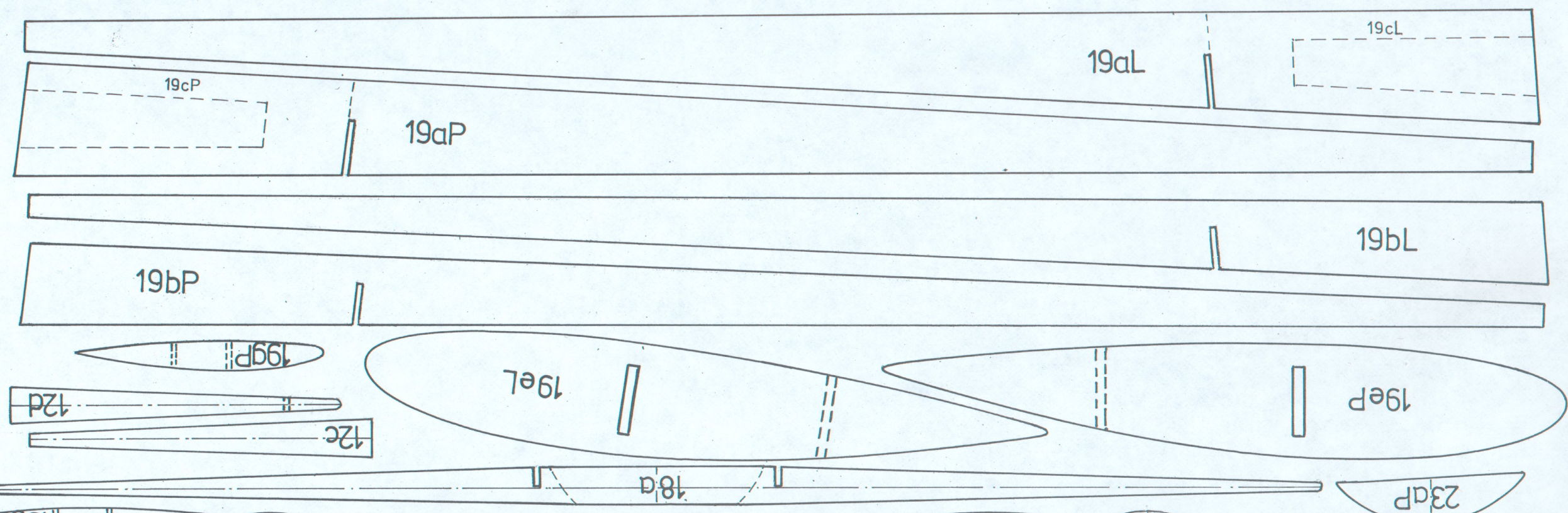
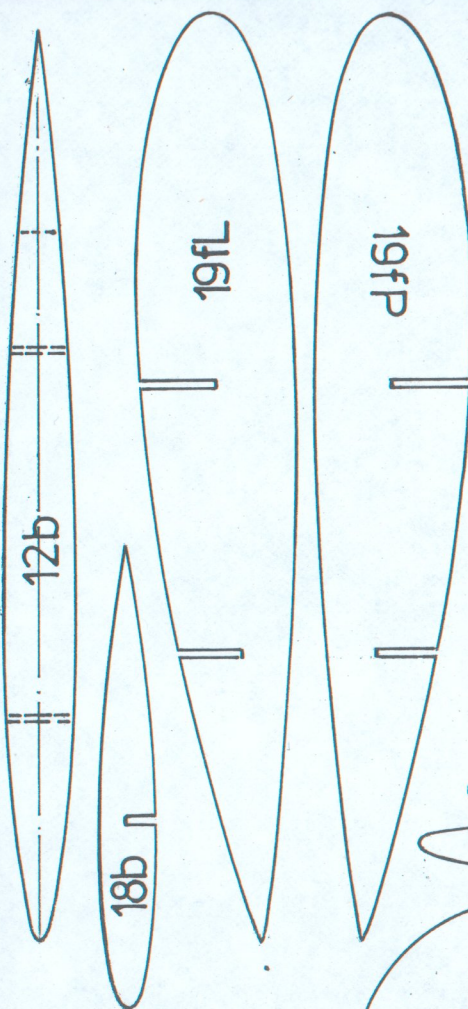

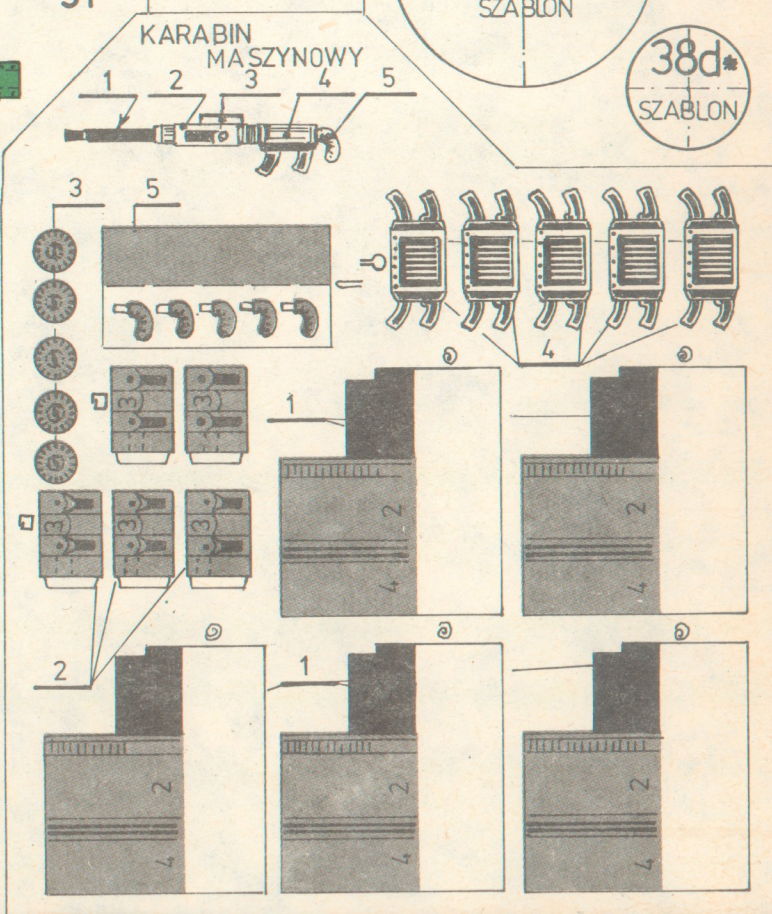
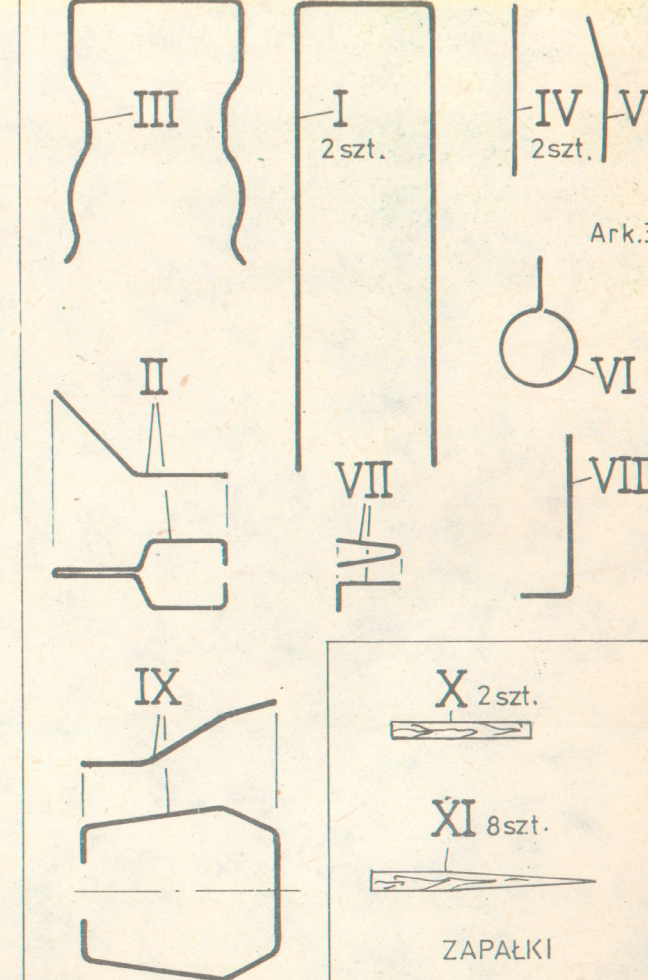
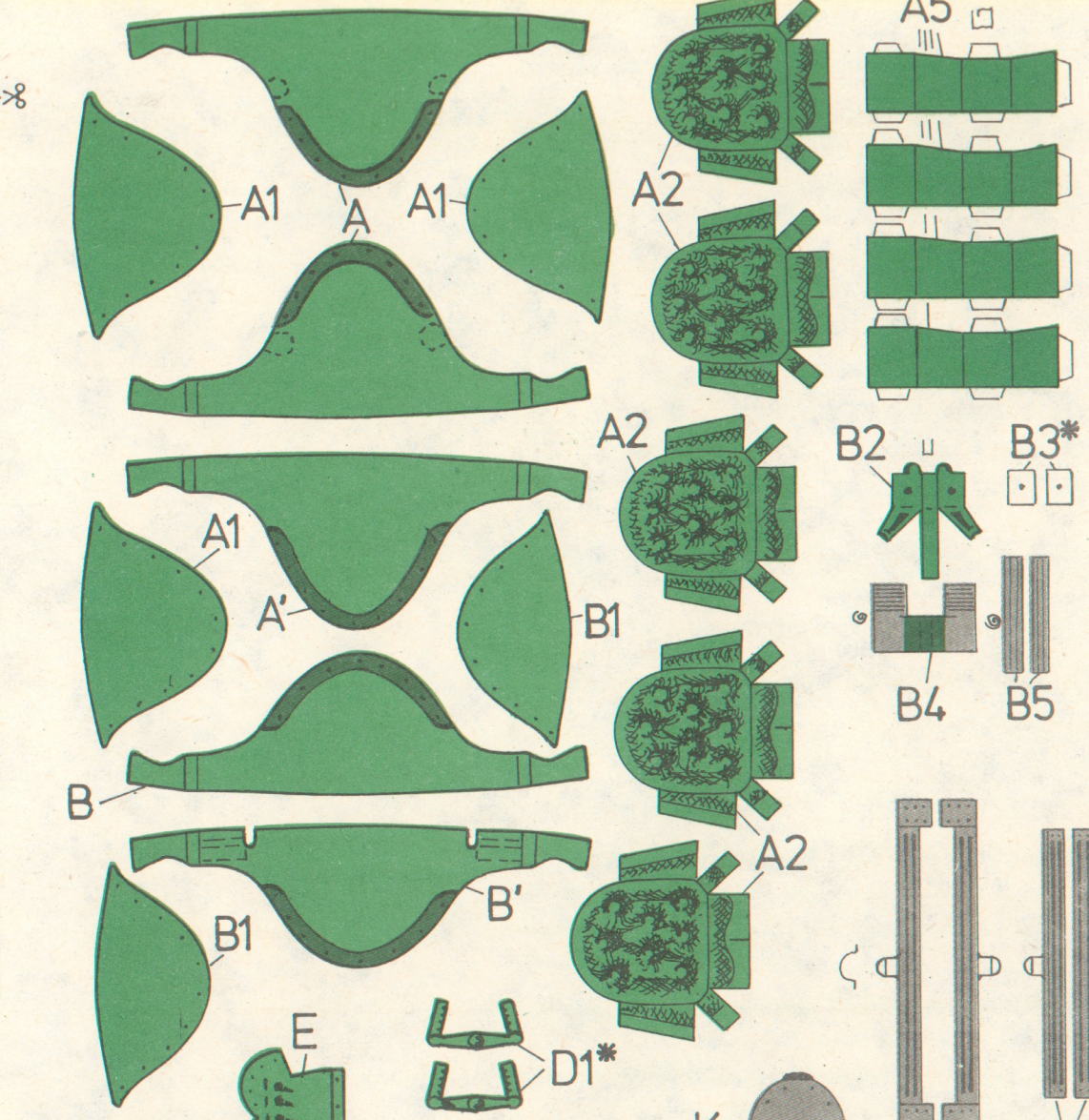
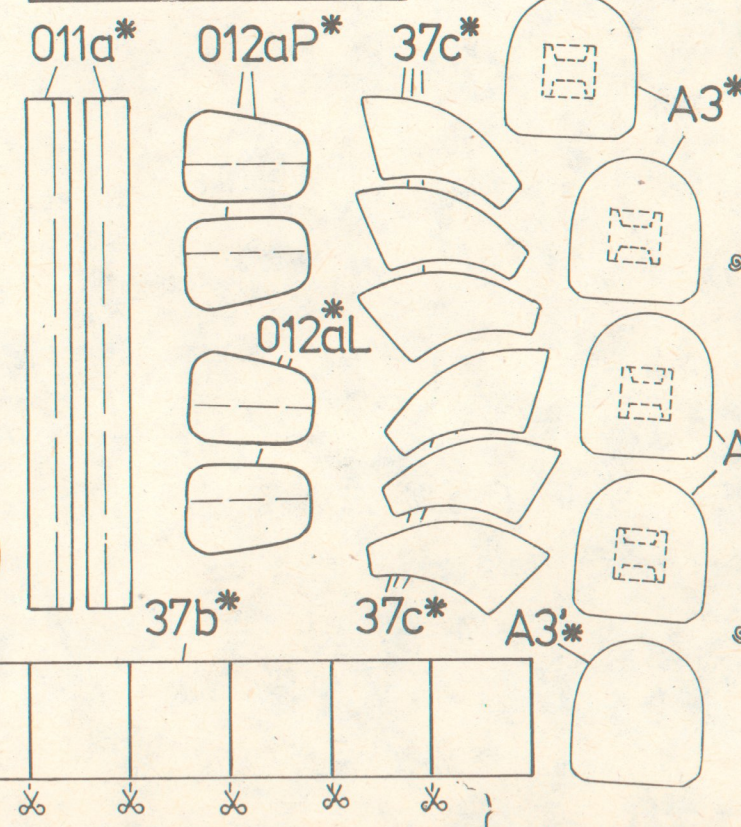
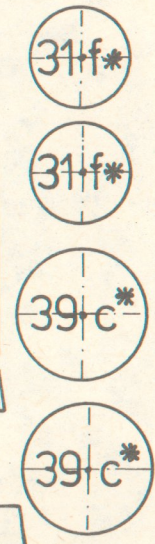
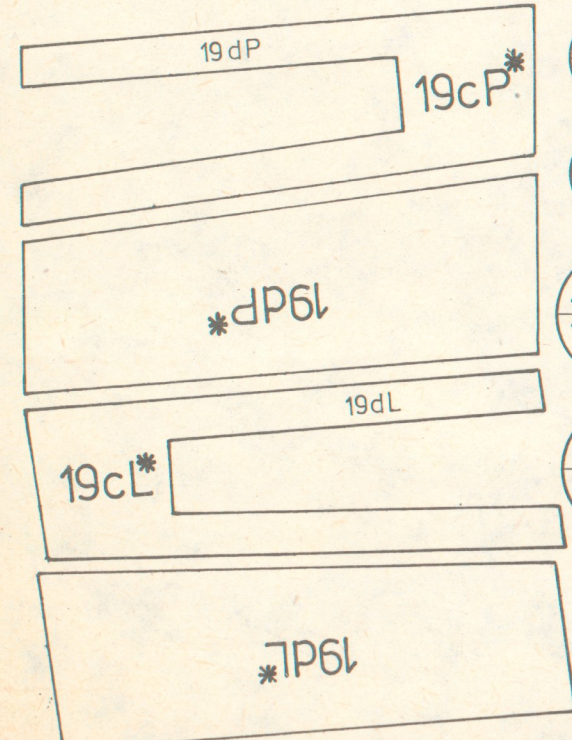
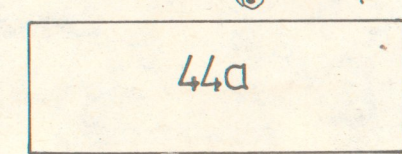
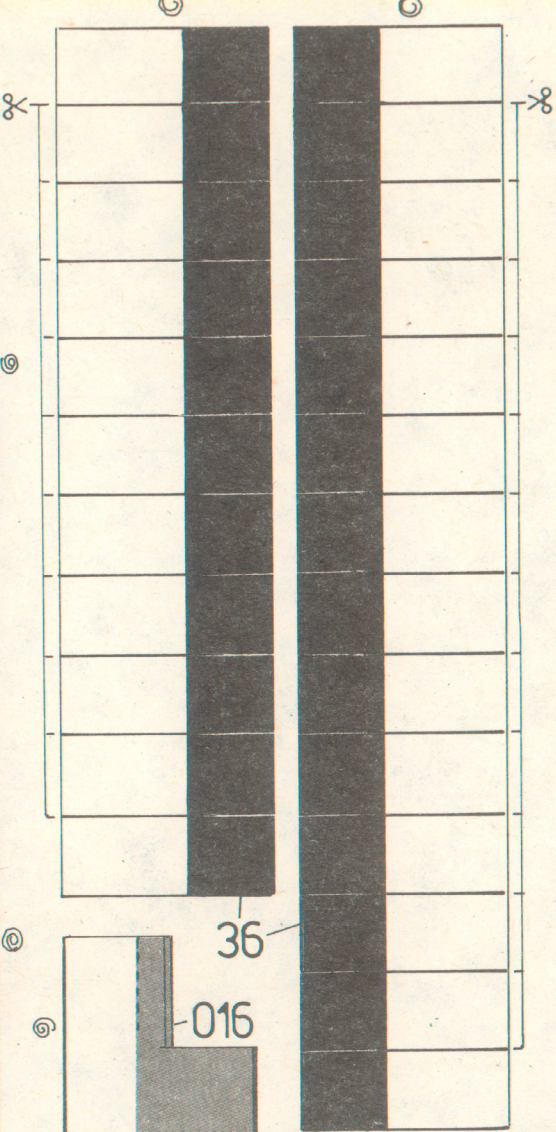
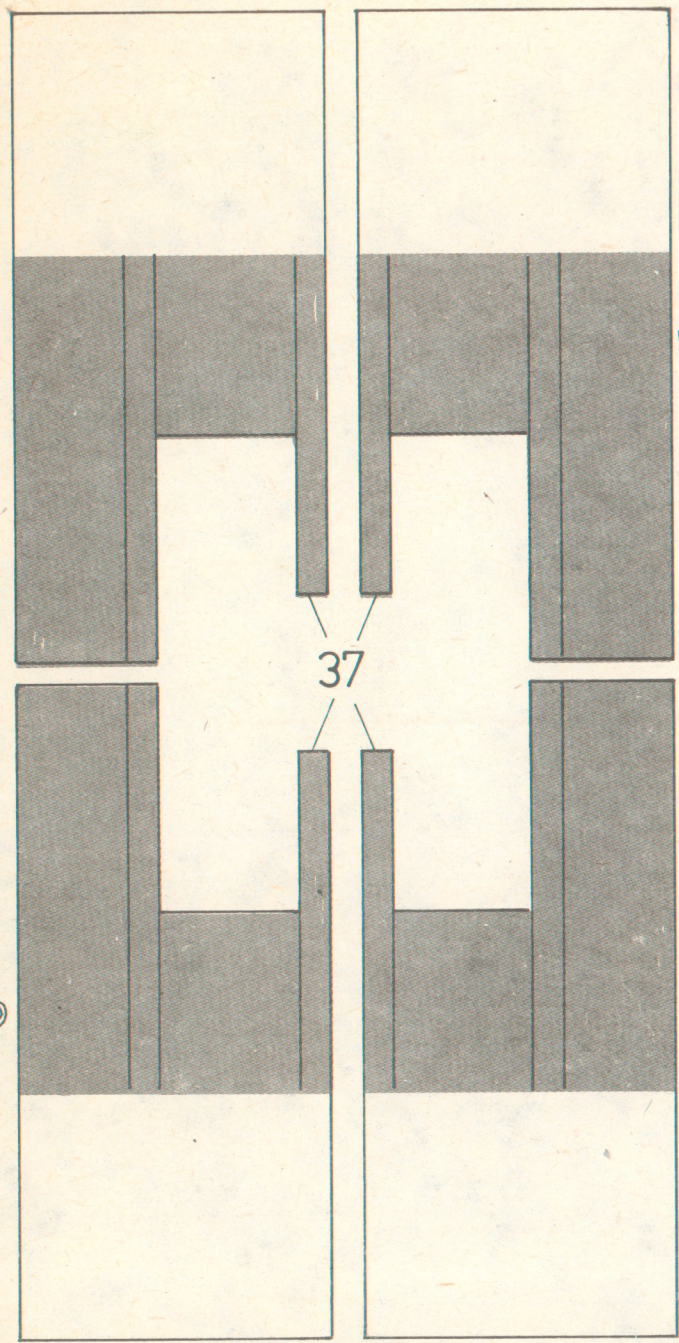

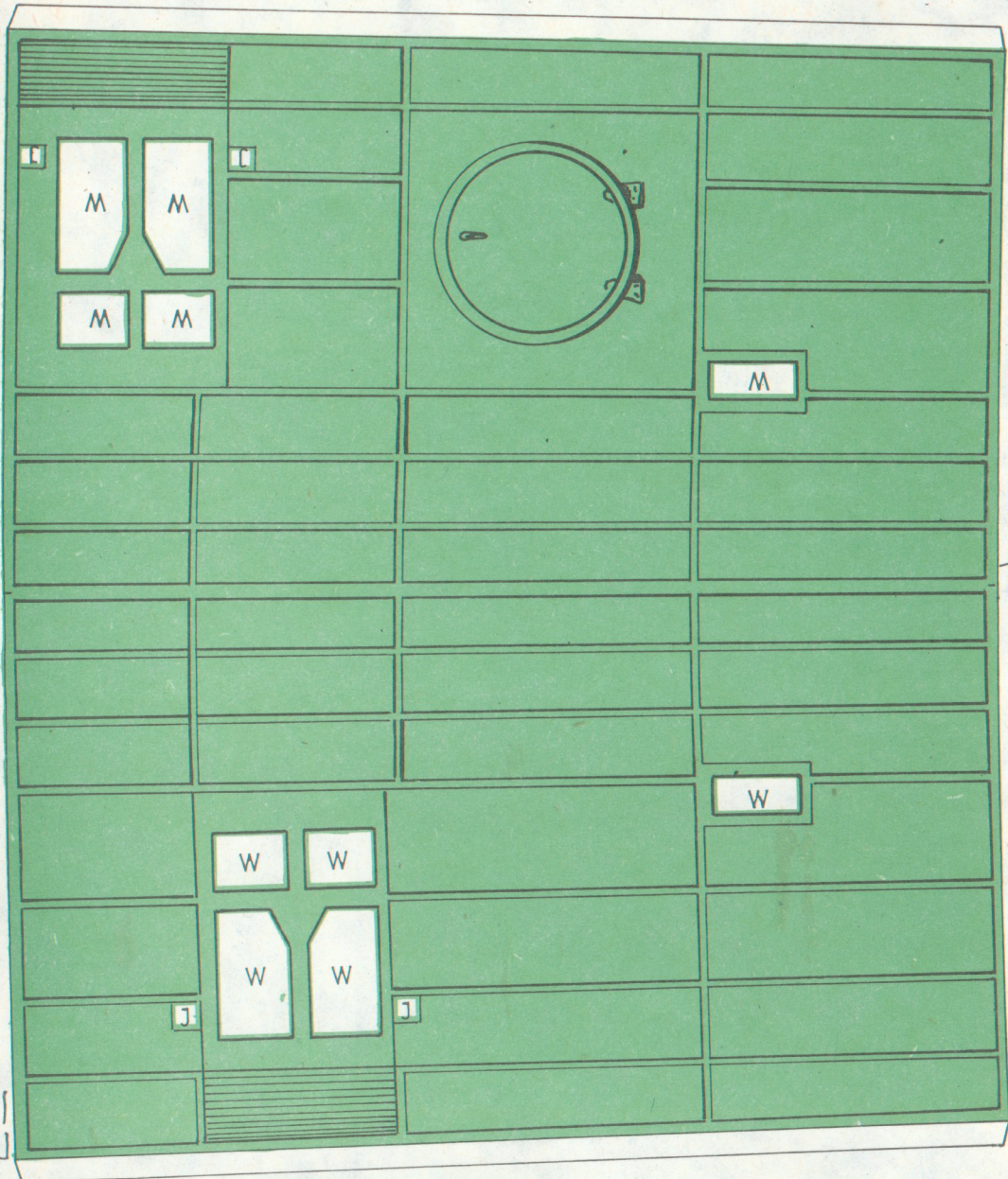

16f*

16e

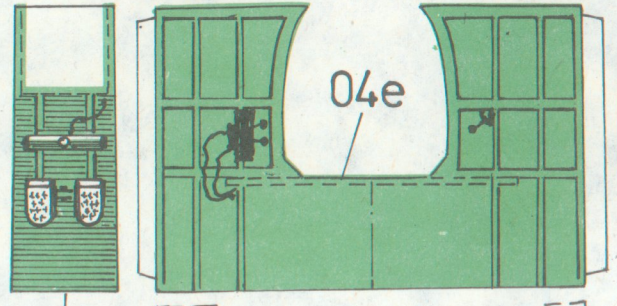
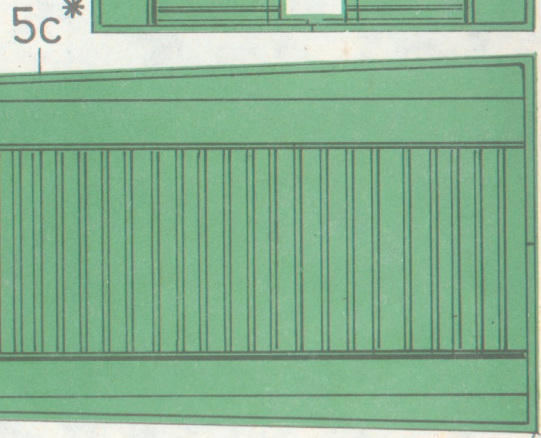
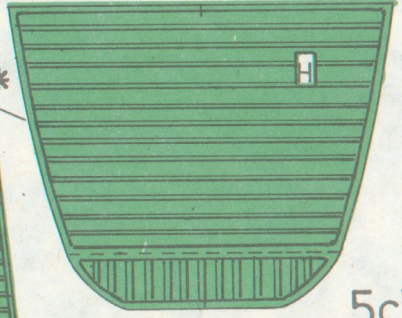
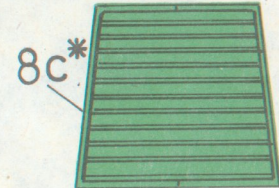
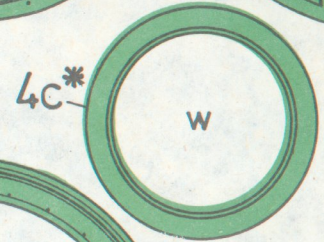
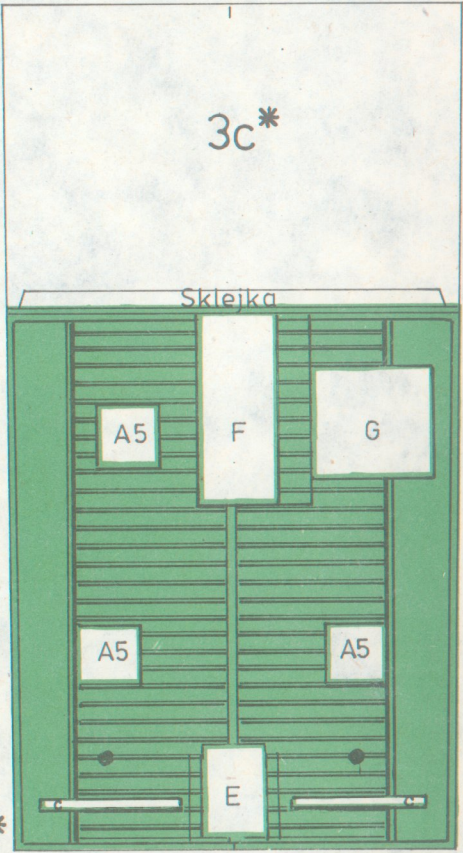
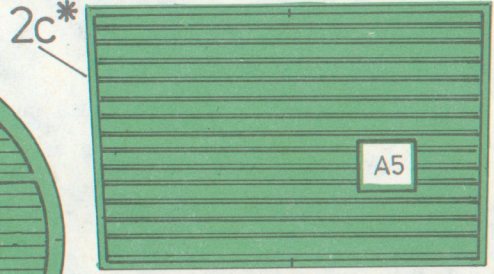
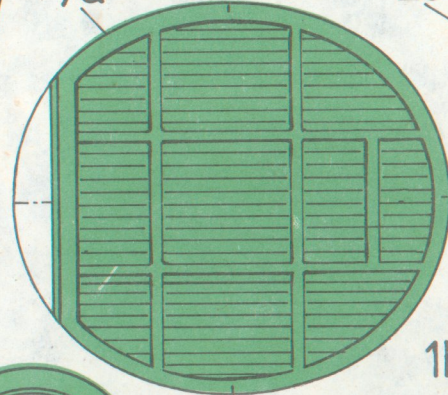
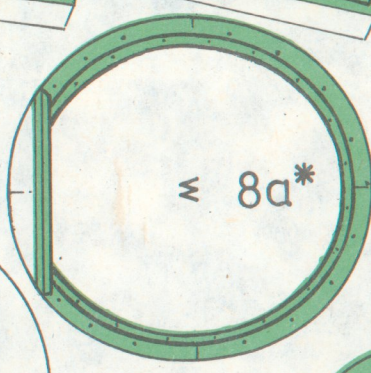
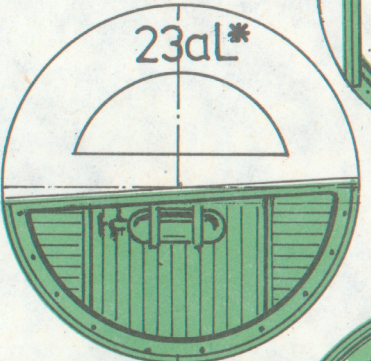
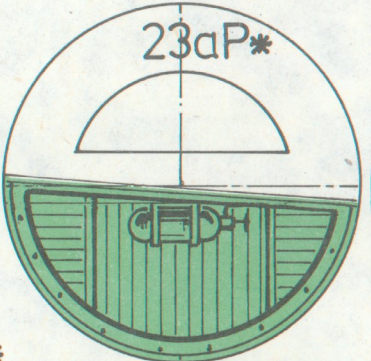
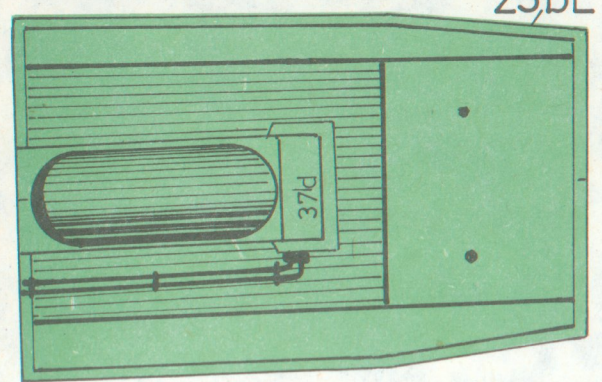
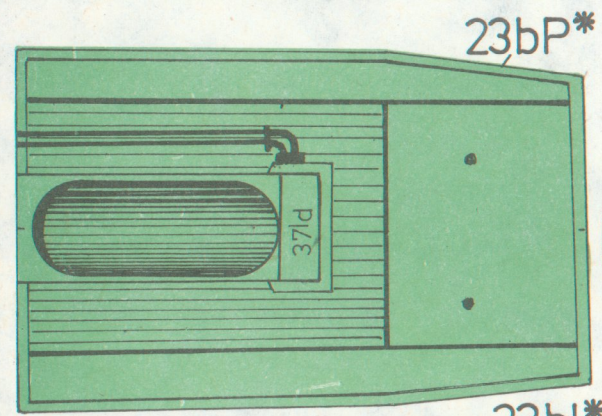
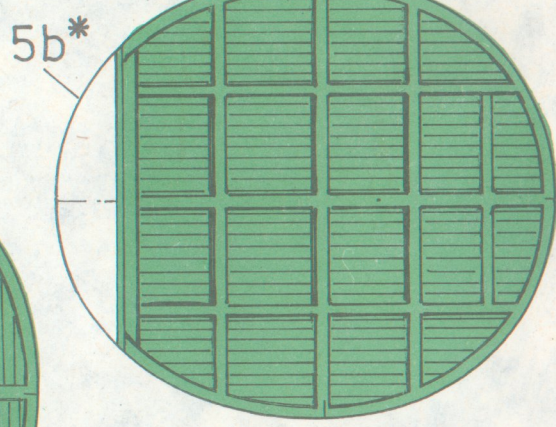
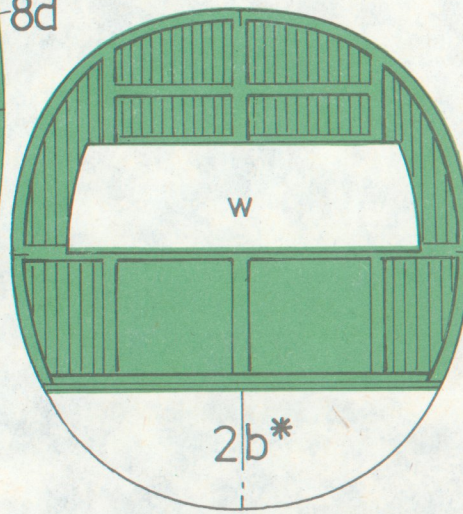
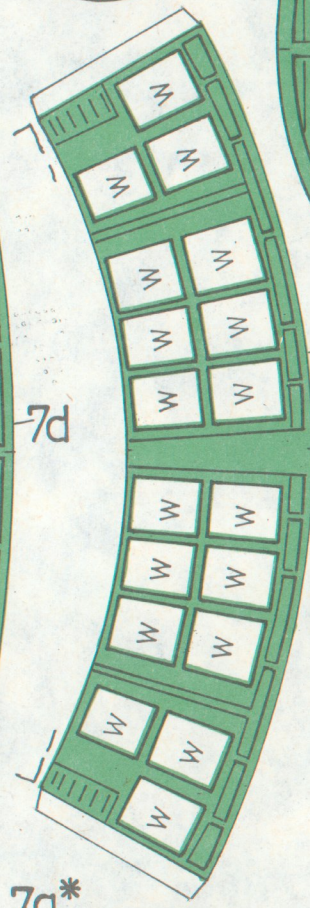
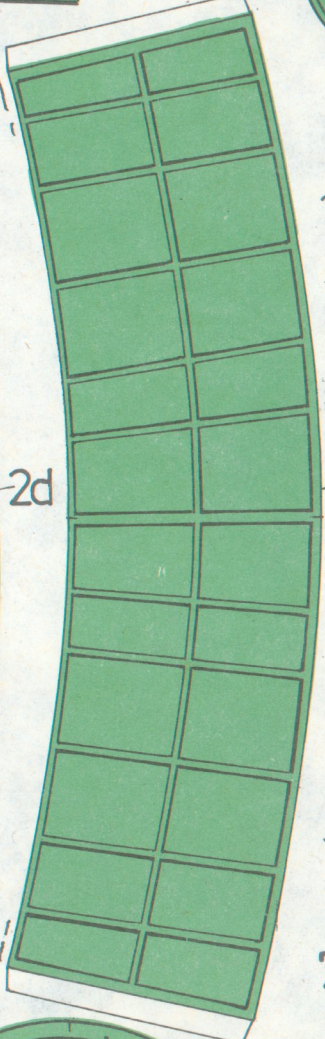
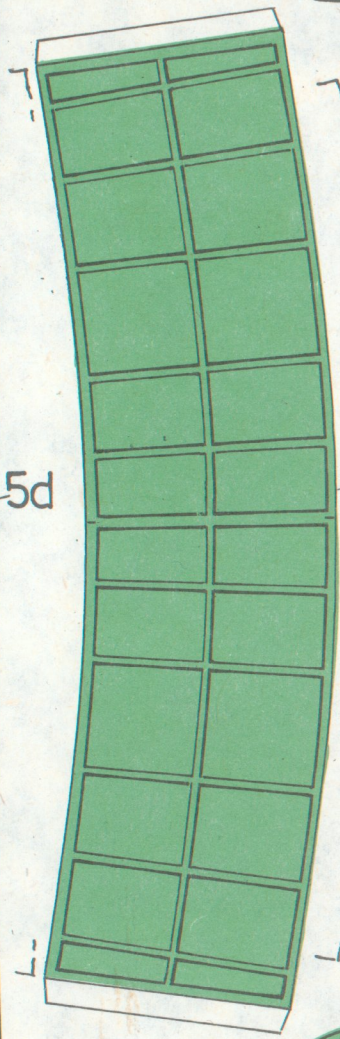
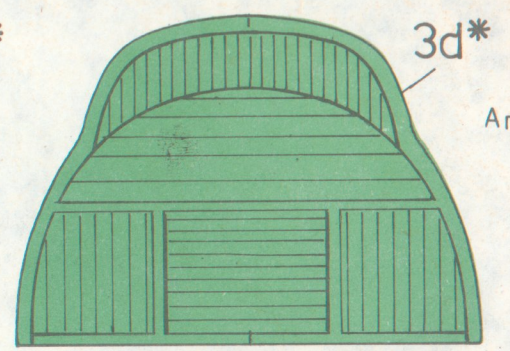
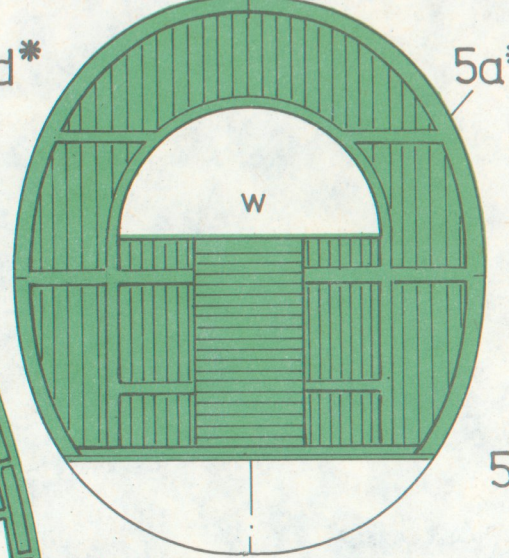
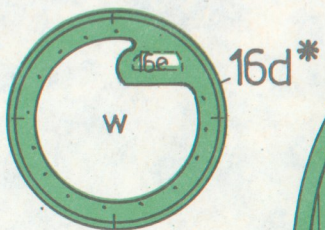

04d*

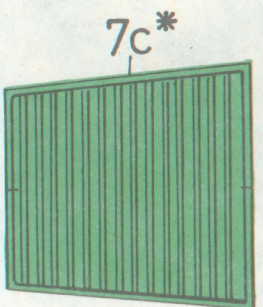
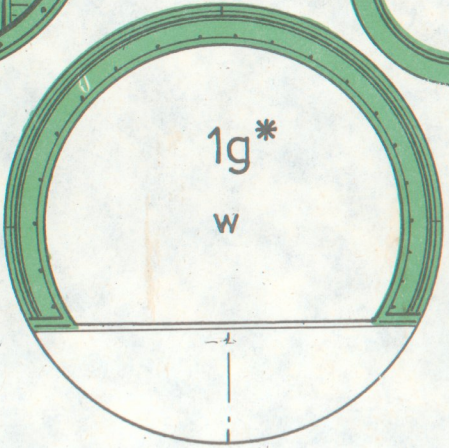

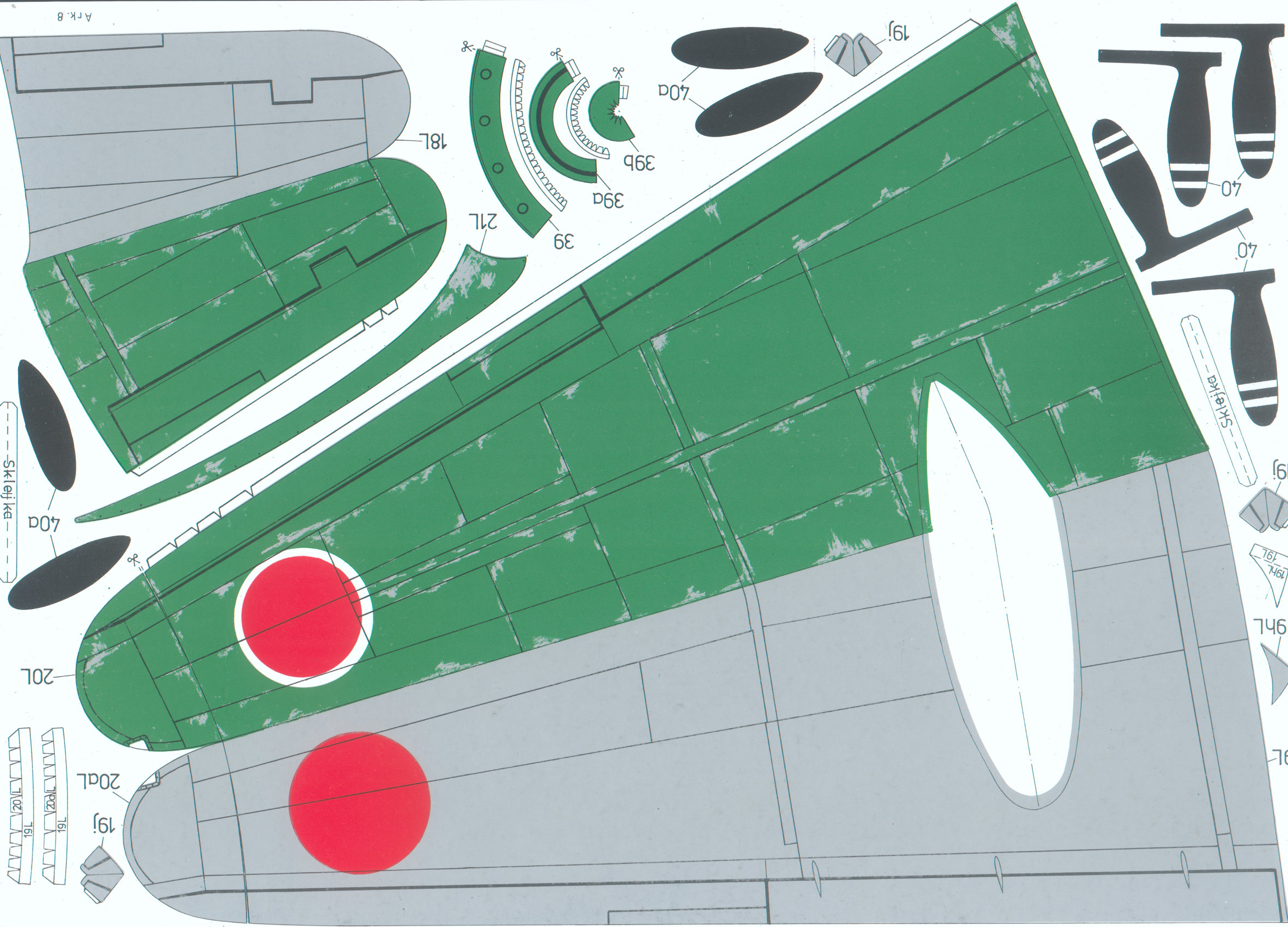

Sklejka

Sklejka

18L

20L

20aL

21L

39

39a

39b

40a

19j

40

40

19j

19k

19l

19m

19L

19L

20L

20aL

19j

19L

20aL

19j

19L

20aL

19j

19L

20aL

19j

19L

20aL

19j

19L

20aL

19j

19L

20aL

19j

19L

20aL

19j

19L

20aL

19j

19L

20aL

19j

19L

20aL

19j

19L

20aL

19j

19L

20aL

19j

19L

20aL

19j

19L

20aL

19j

19L

20aL

19j

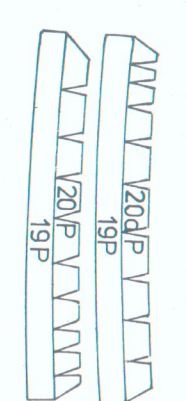
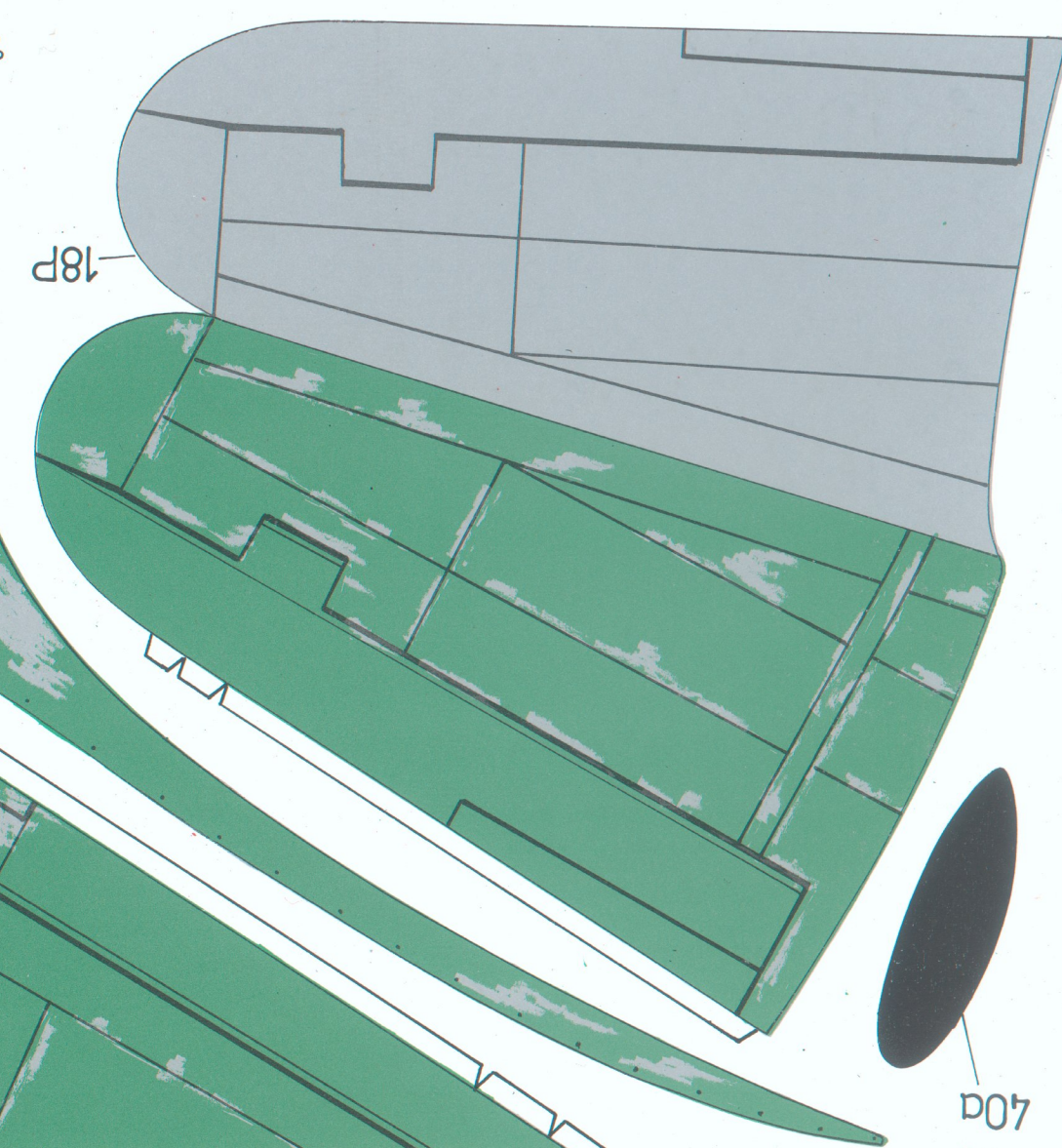
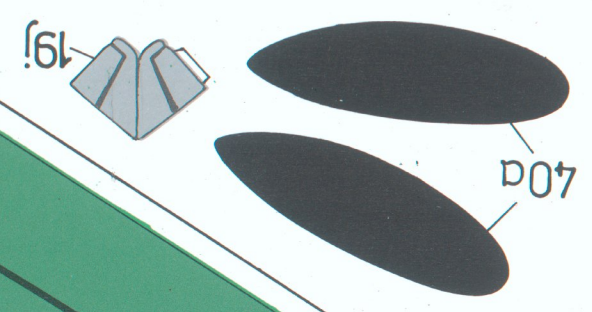
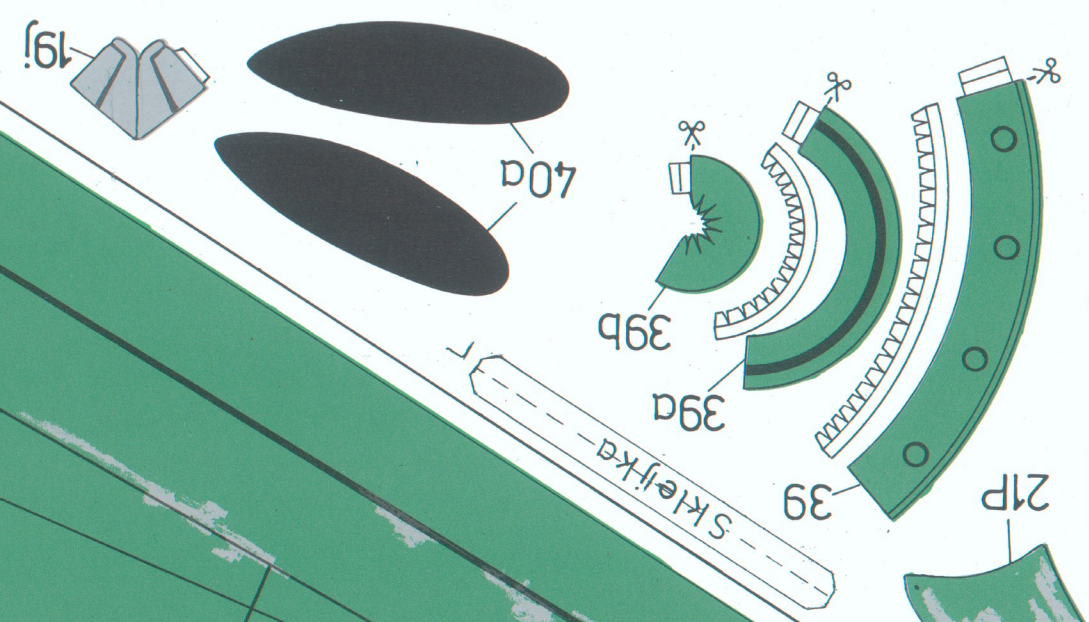
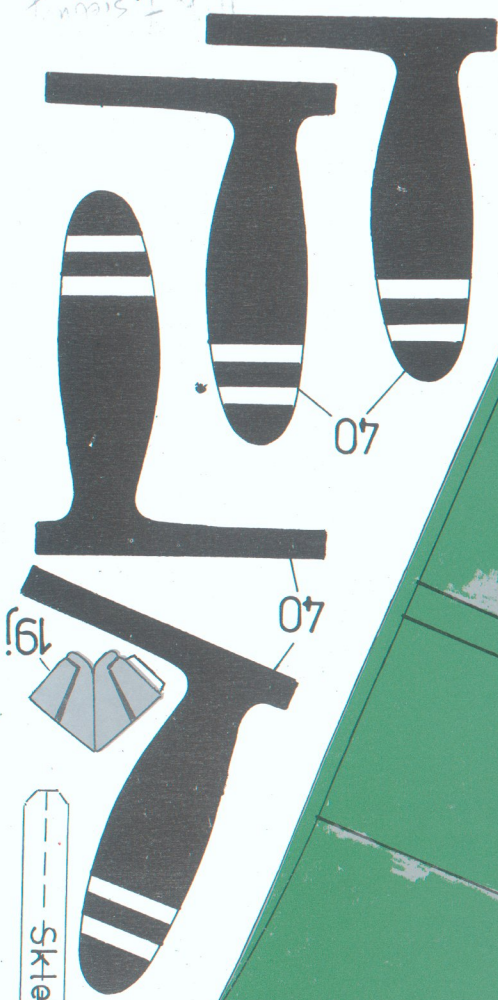
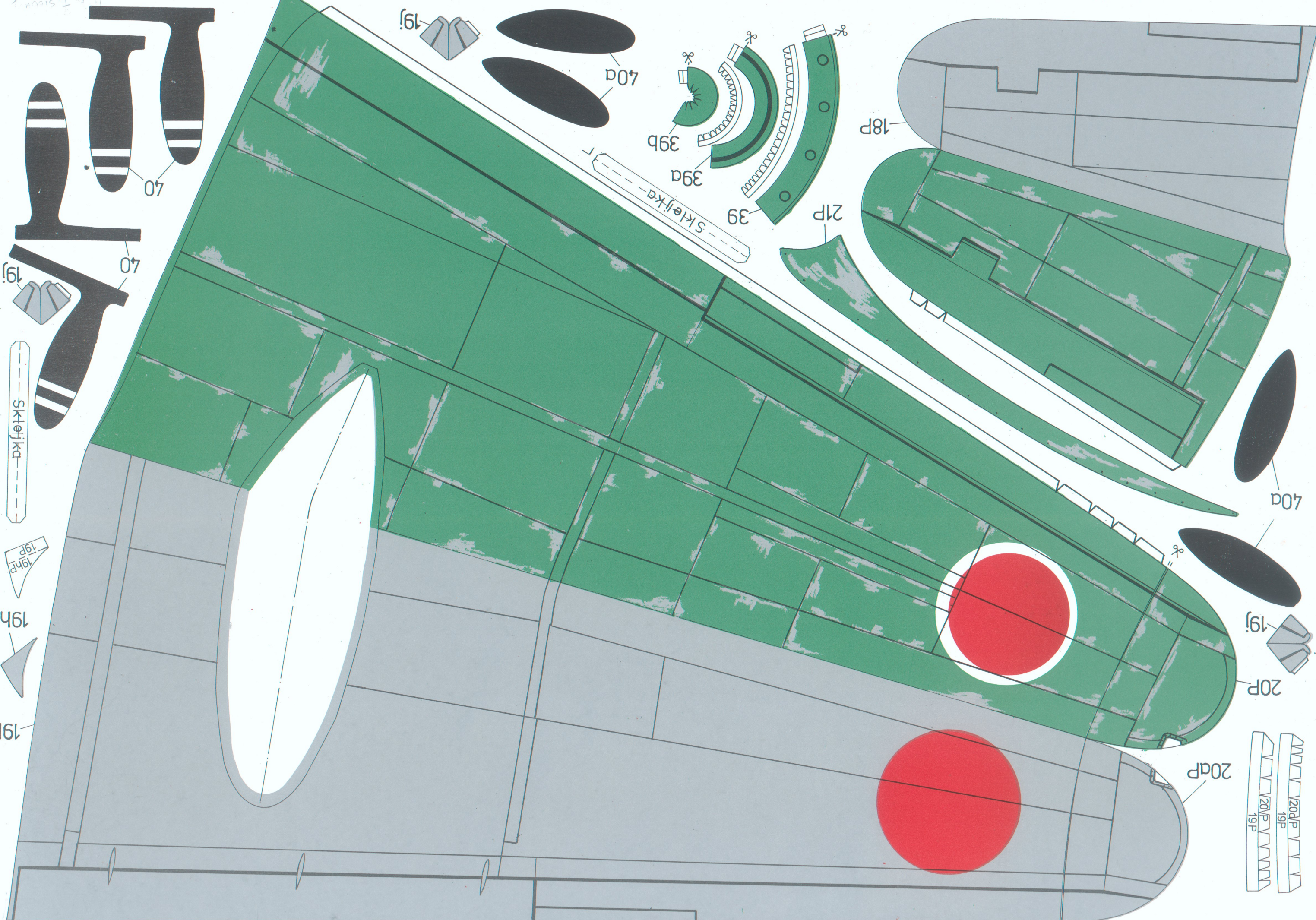

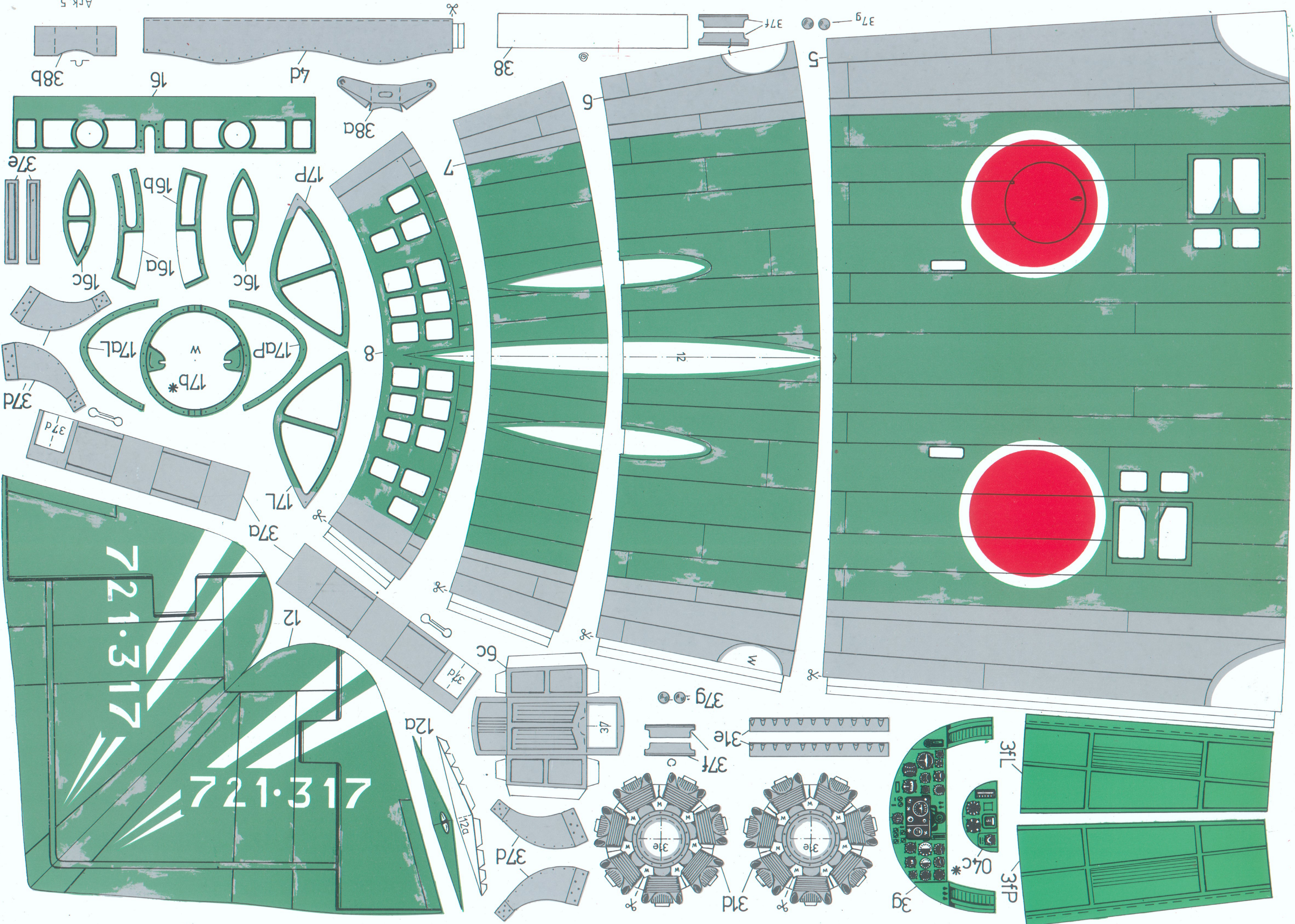

721.317

721.317

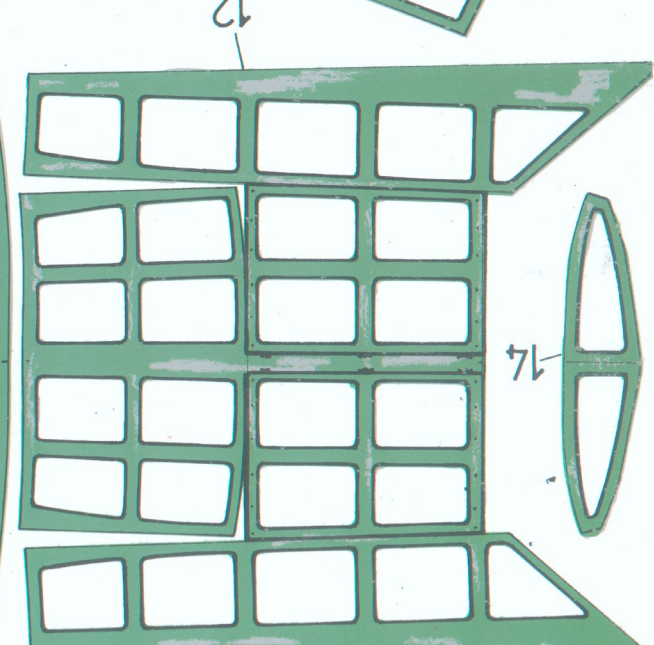
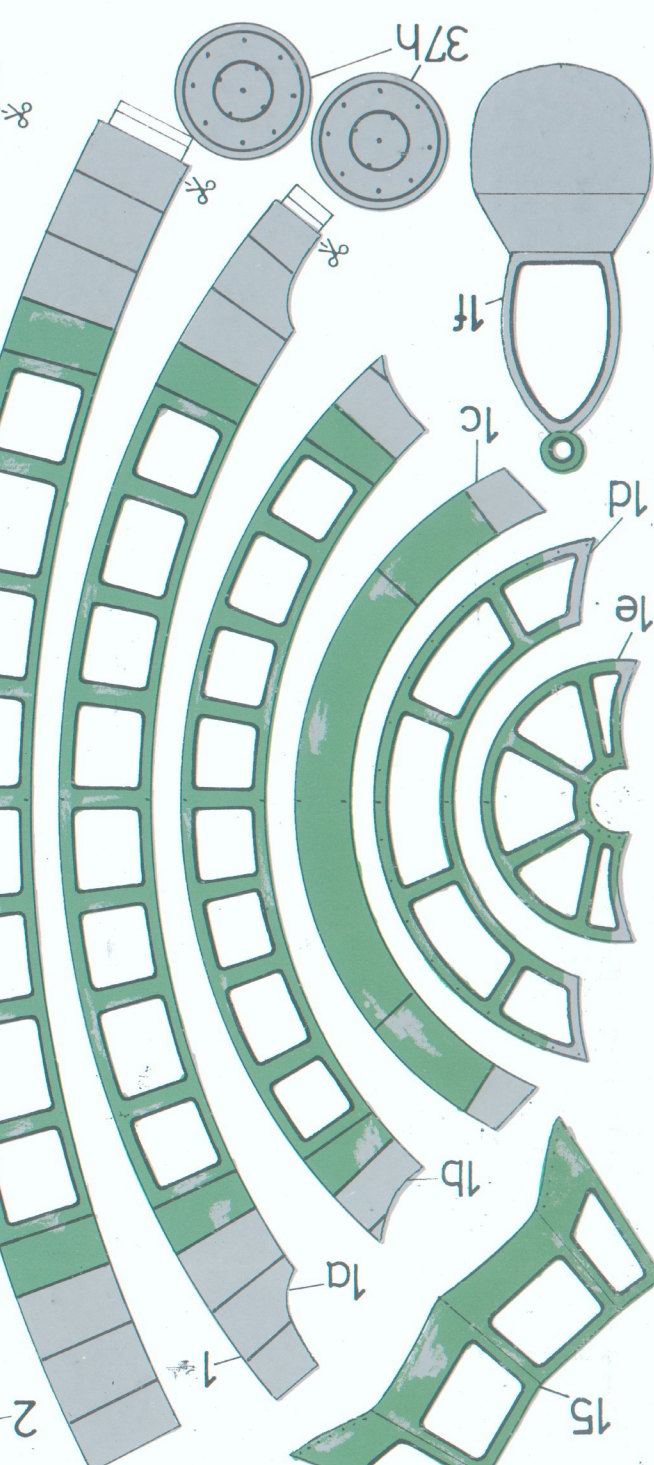
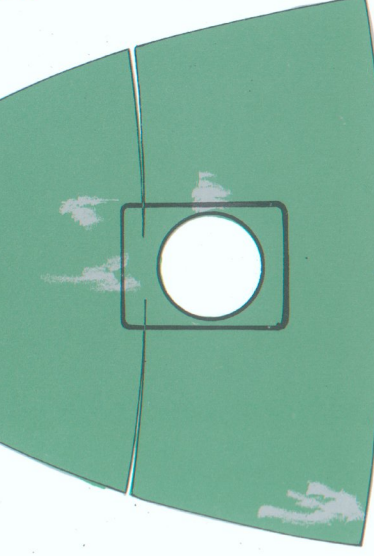
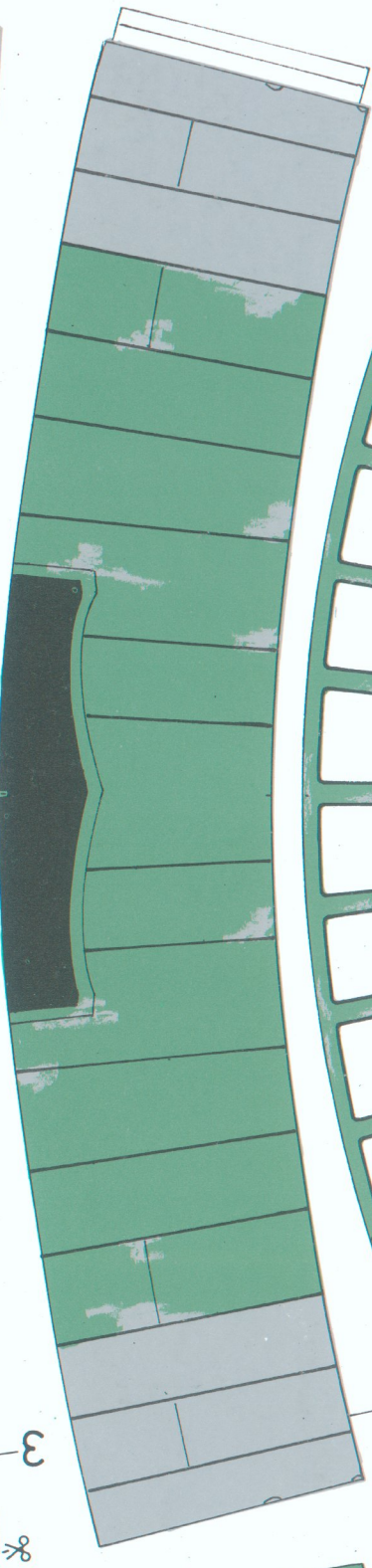
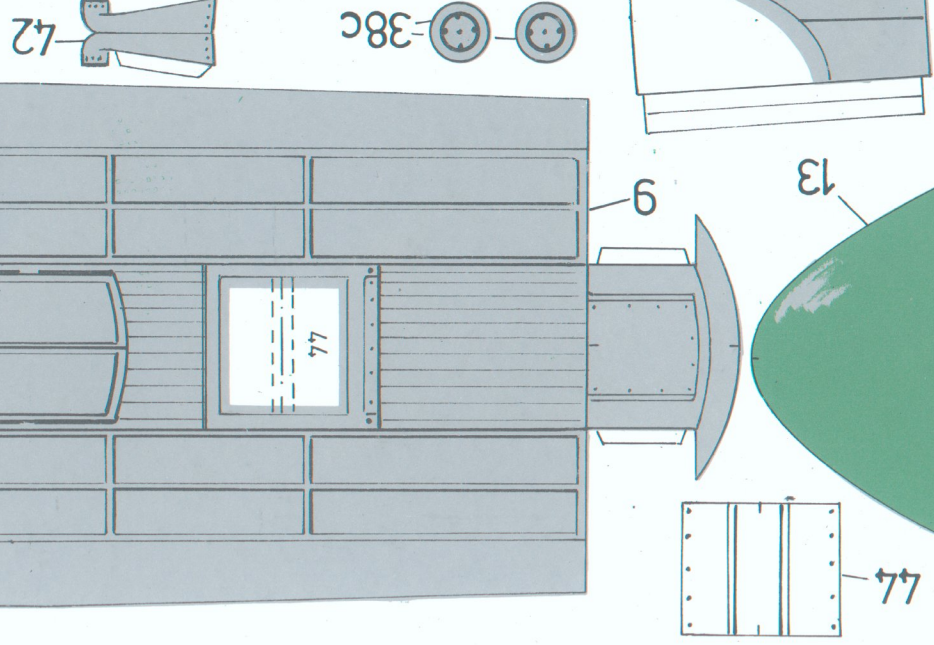
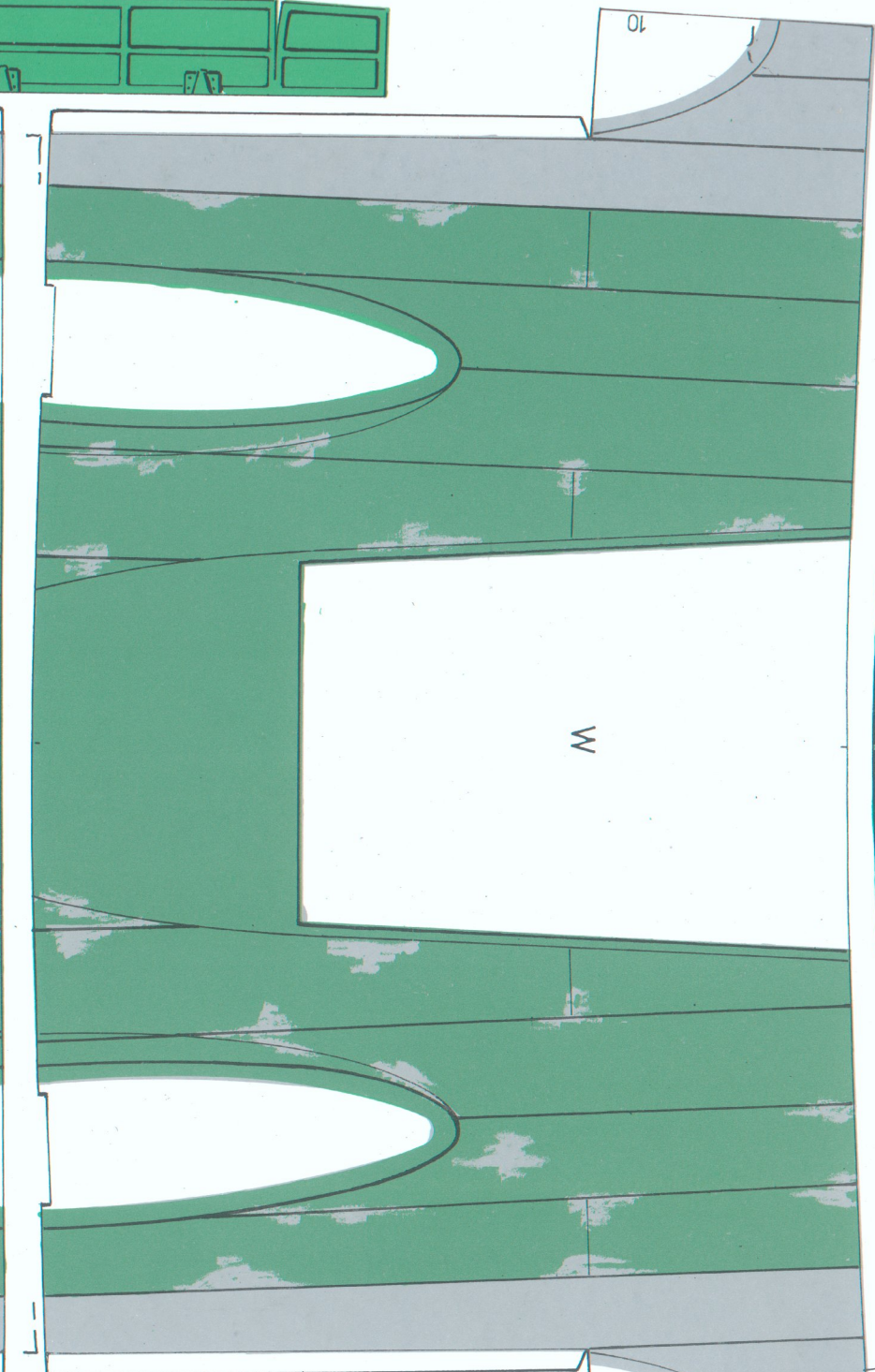
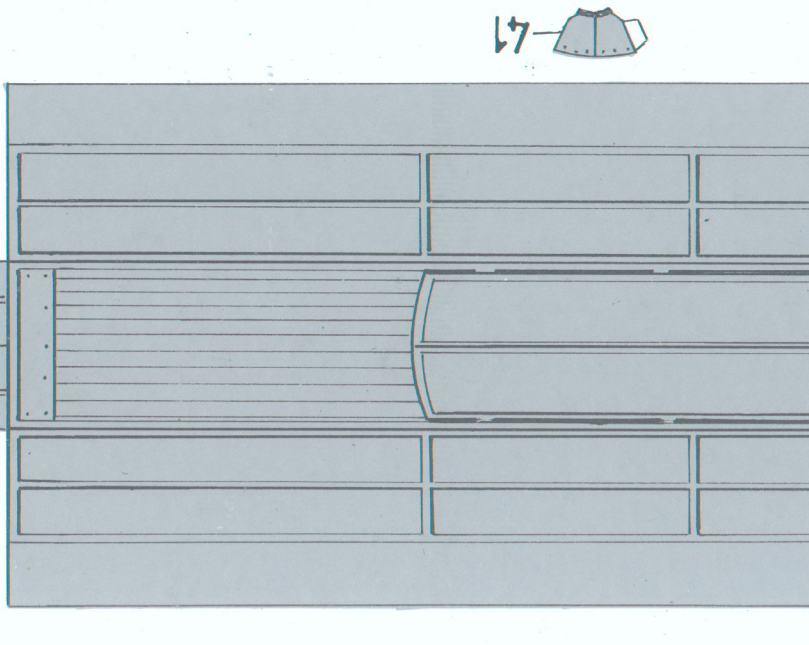
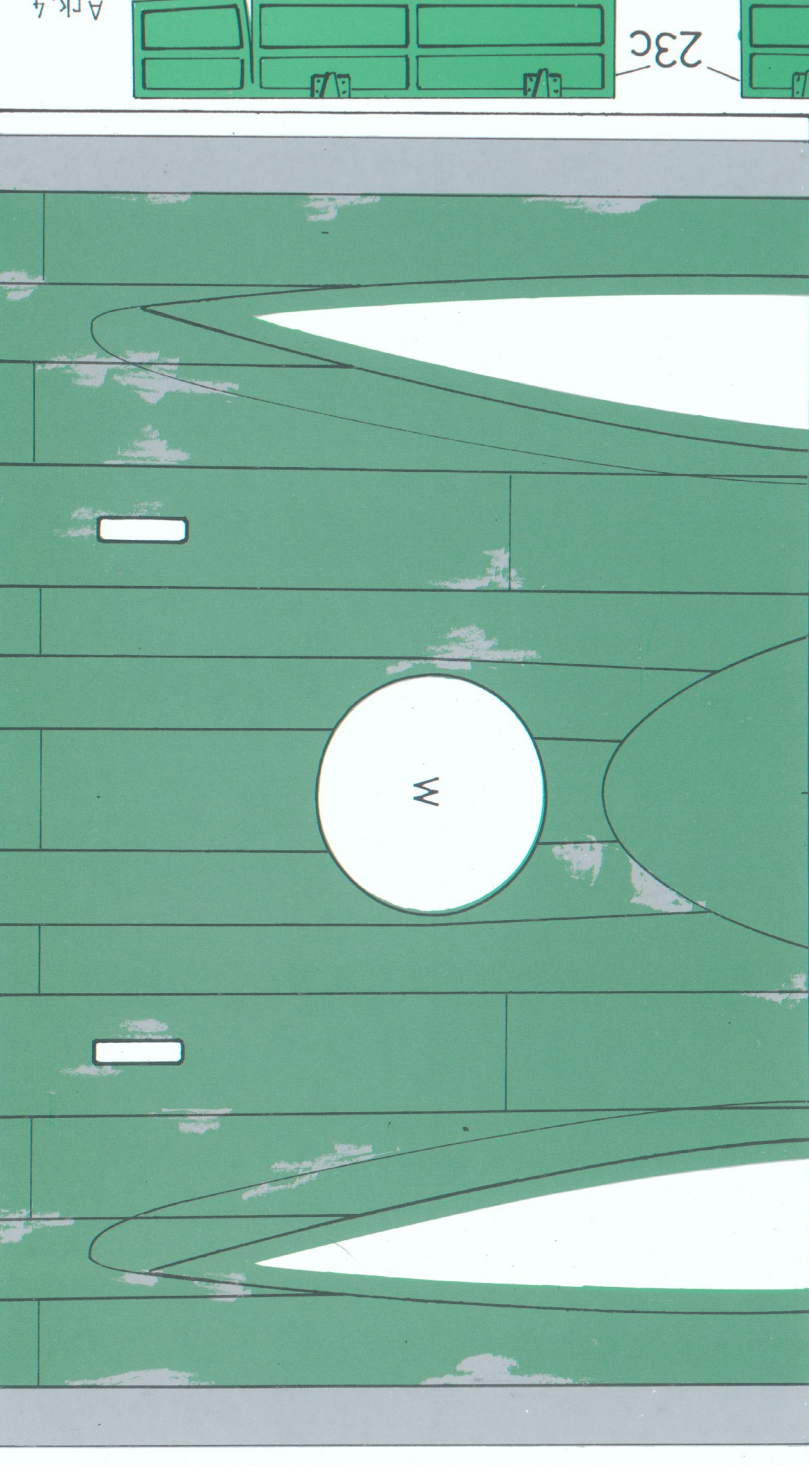
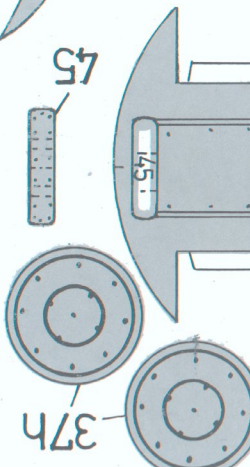
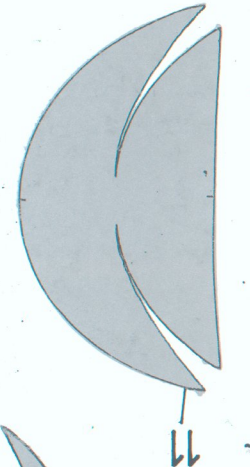
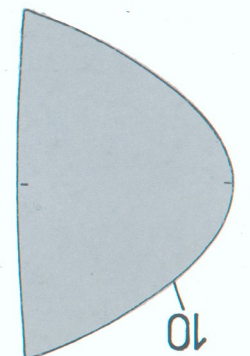
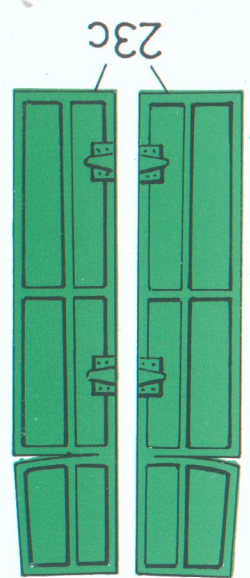

RYUNKI MONTAOWE

4

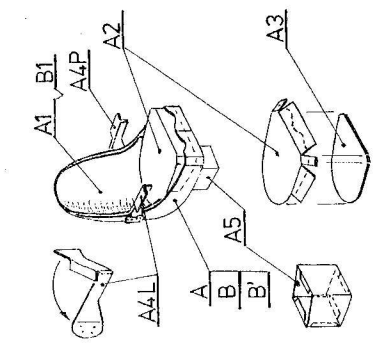

3

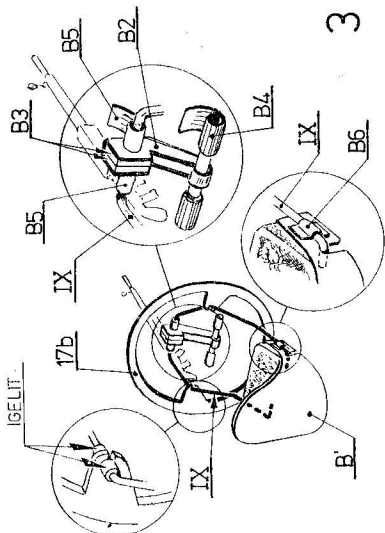

13

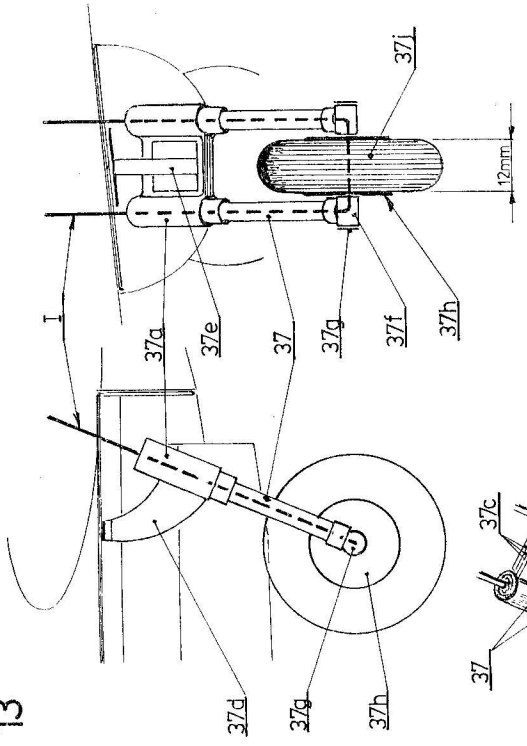

17

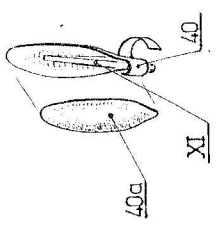

18

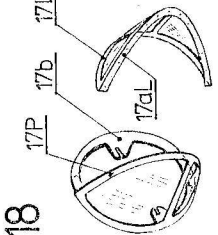

19

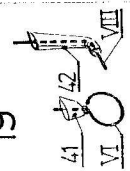

20

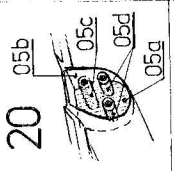

5

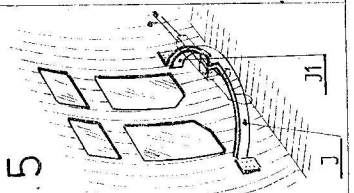

2

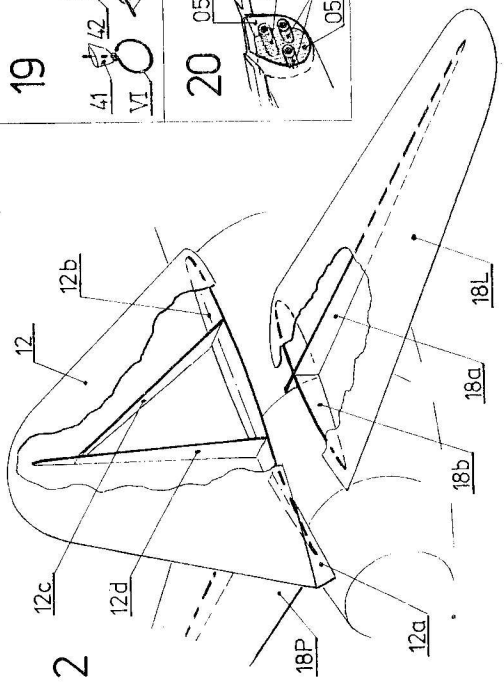

6

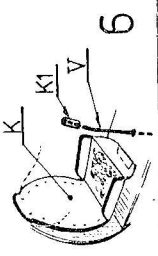

7

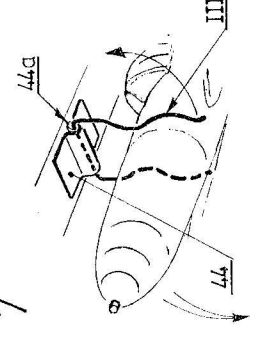

15

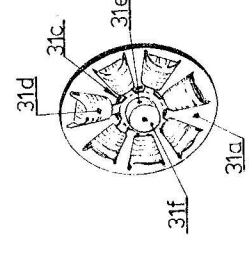

14

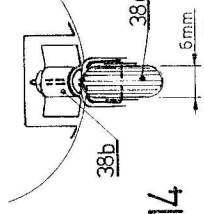

16

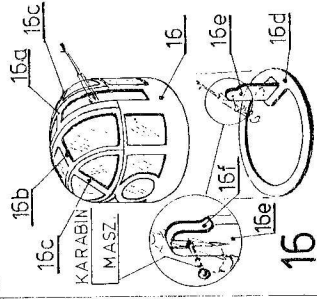

8

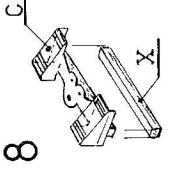

9

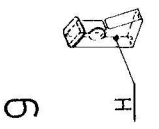

10

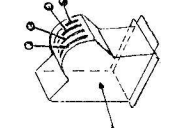

11

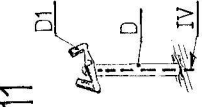

12

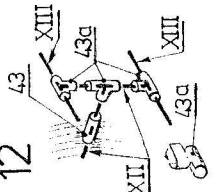

1

