

A1

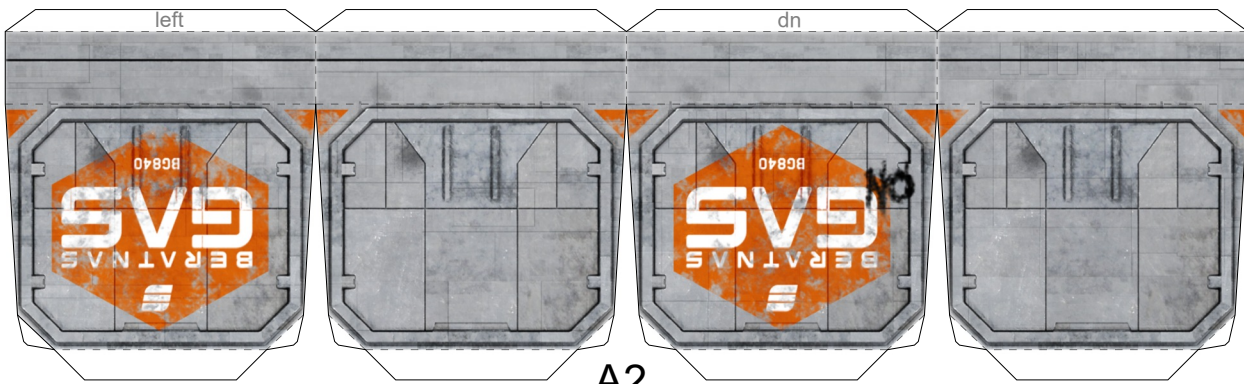

A2

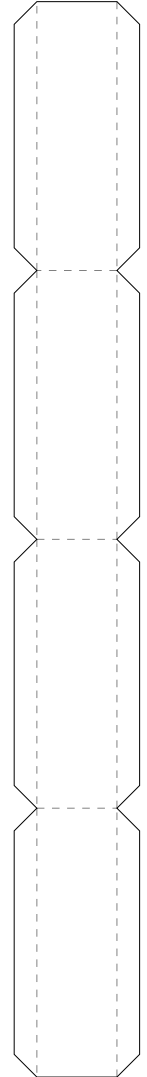

A6

MCRN CORVETTE CLASS
ROCINANTE
 MODEL BY: MICHAEL GROSBERG
 GROSBERG.MICHAEL@GMAIL.COM

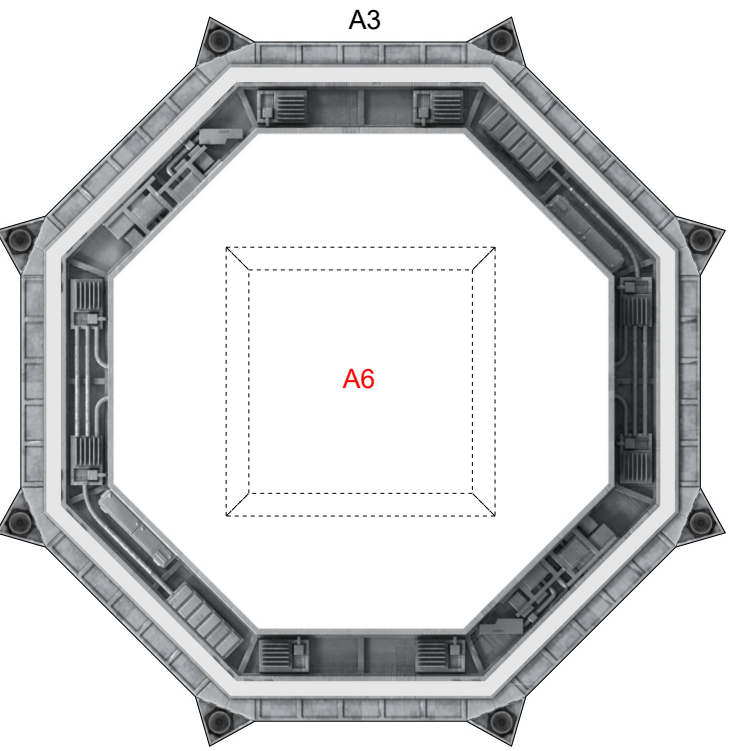

A3

A6

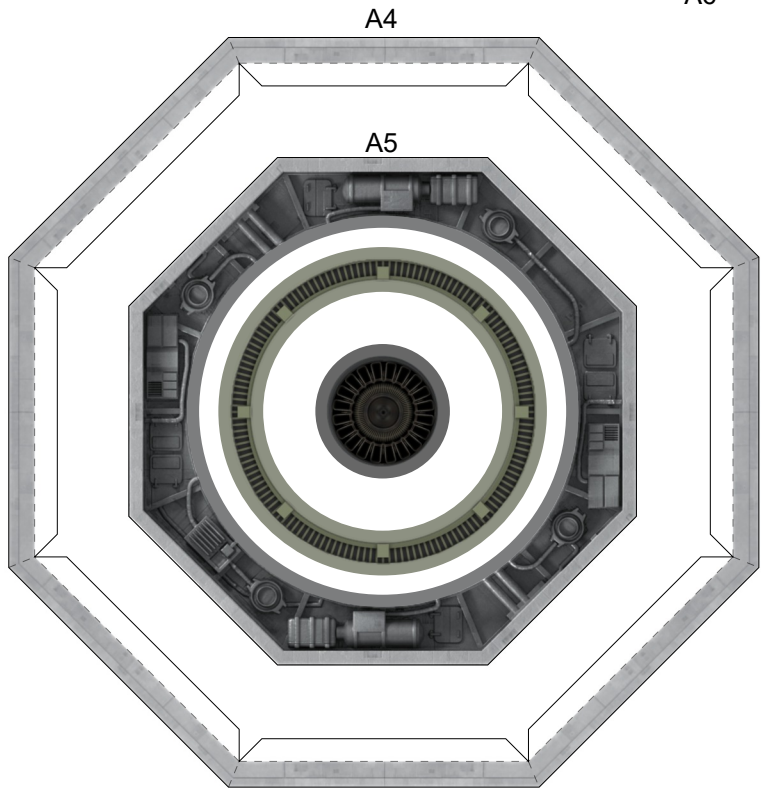

A4

A5

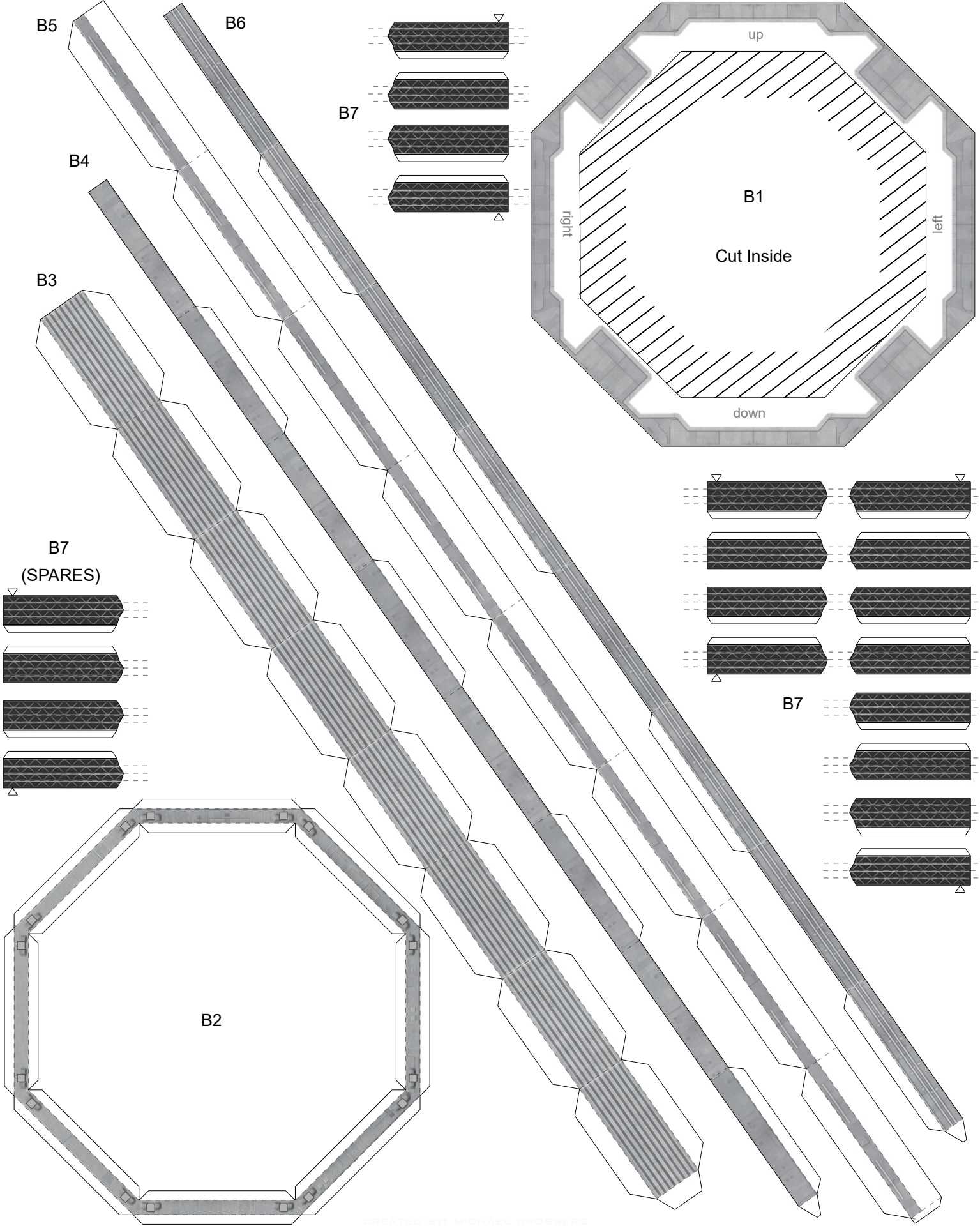

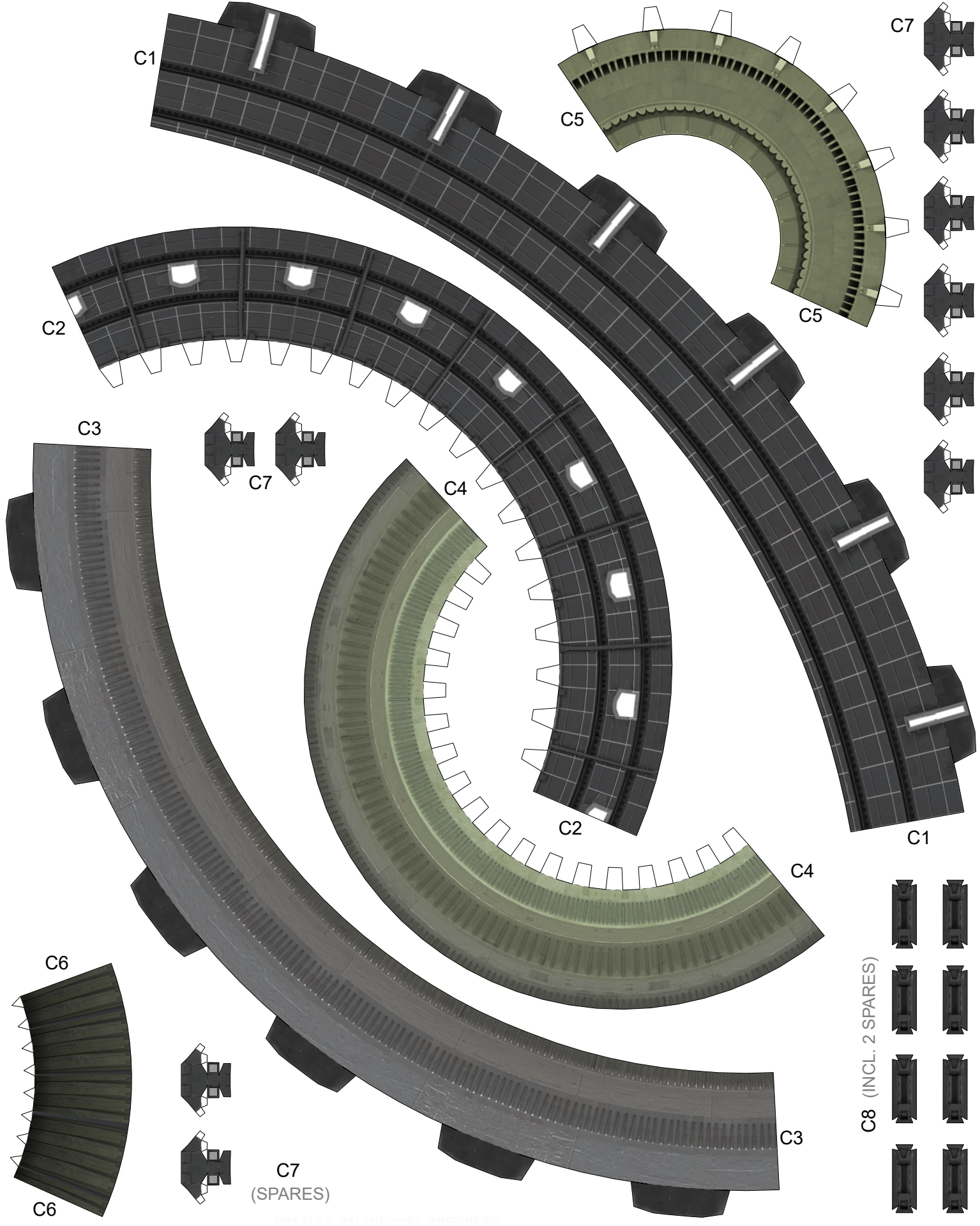

C1

C2

C3

C6

C6

C7

C7
(SPARES)

C5

C4

C2

C4

C3

C7

C8
(INCL. 2 SPARES)

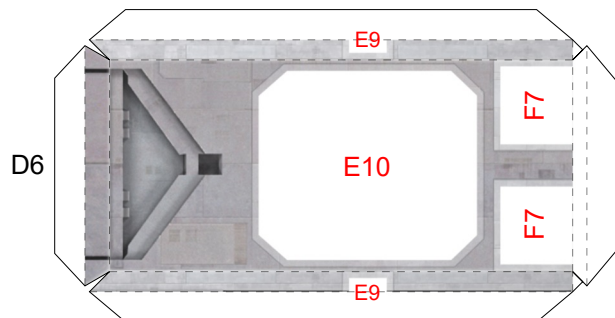
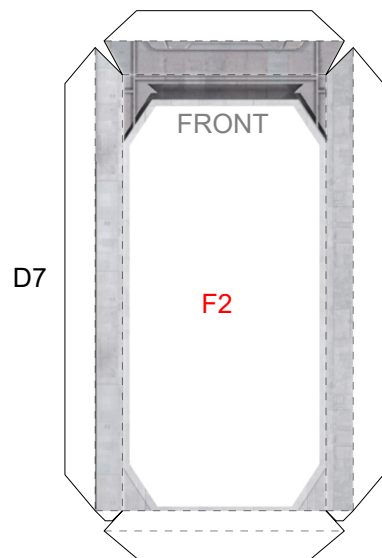
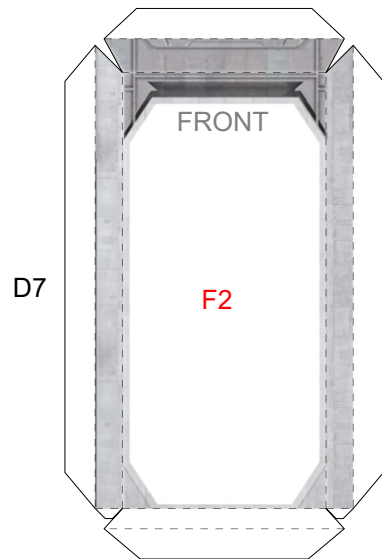
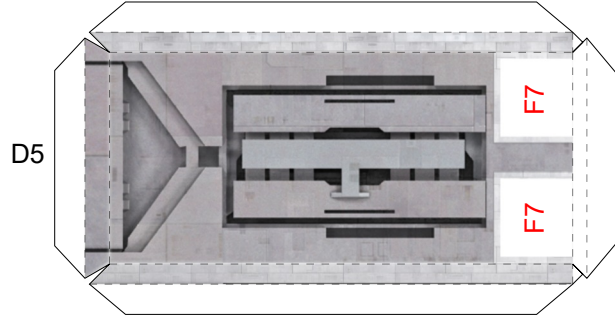
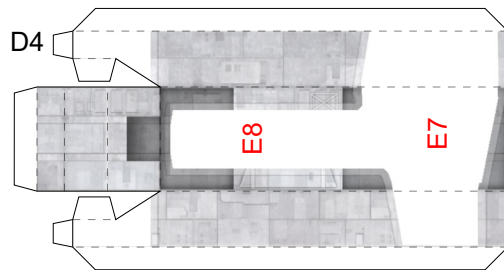
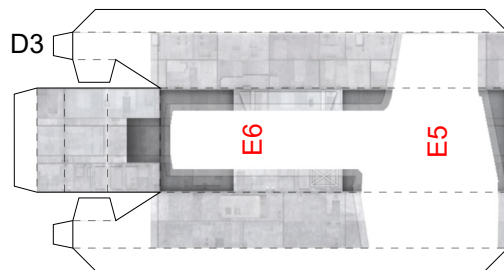
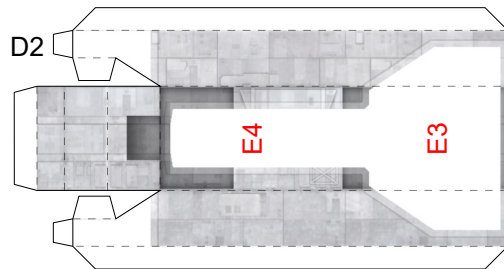
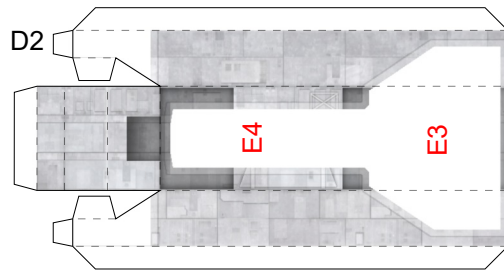
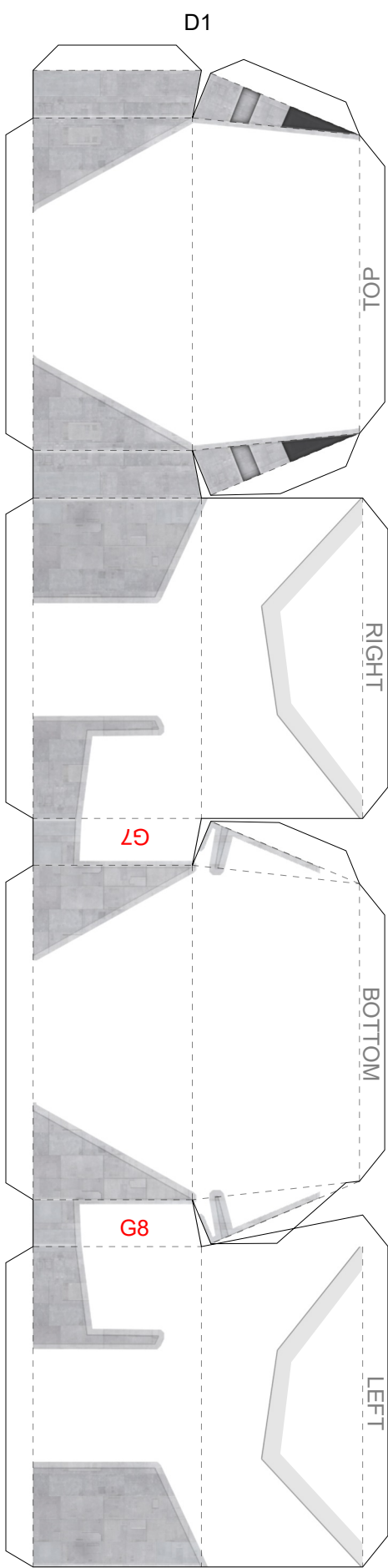

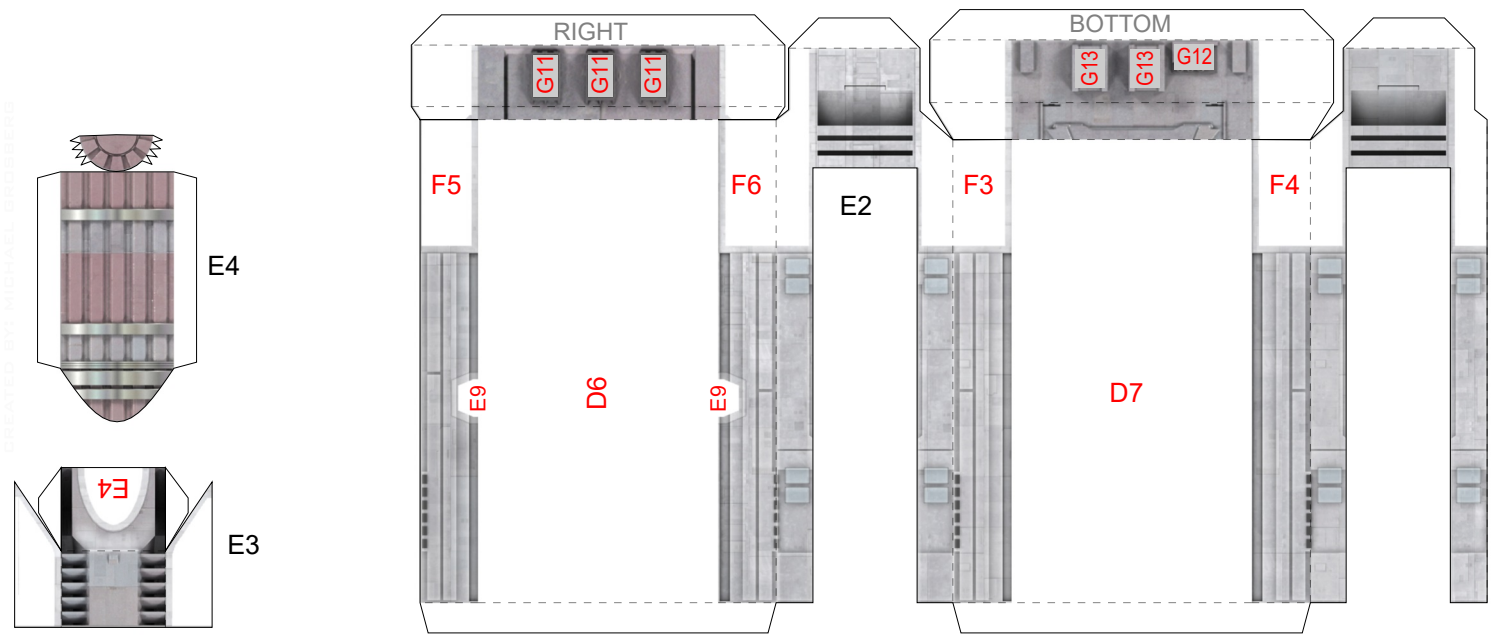
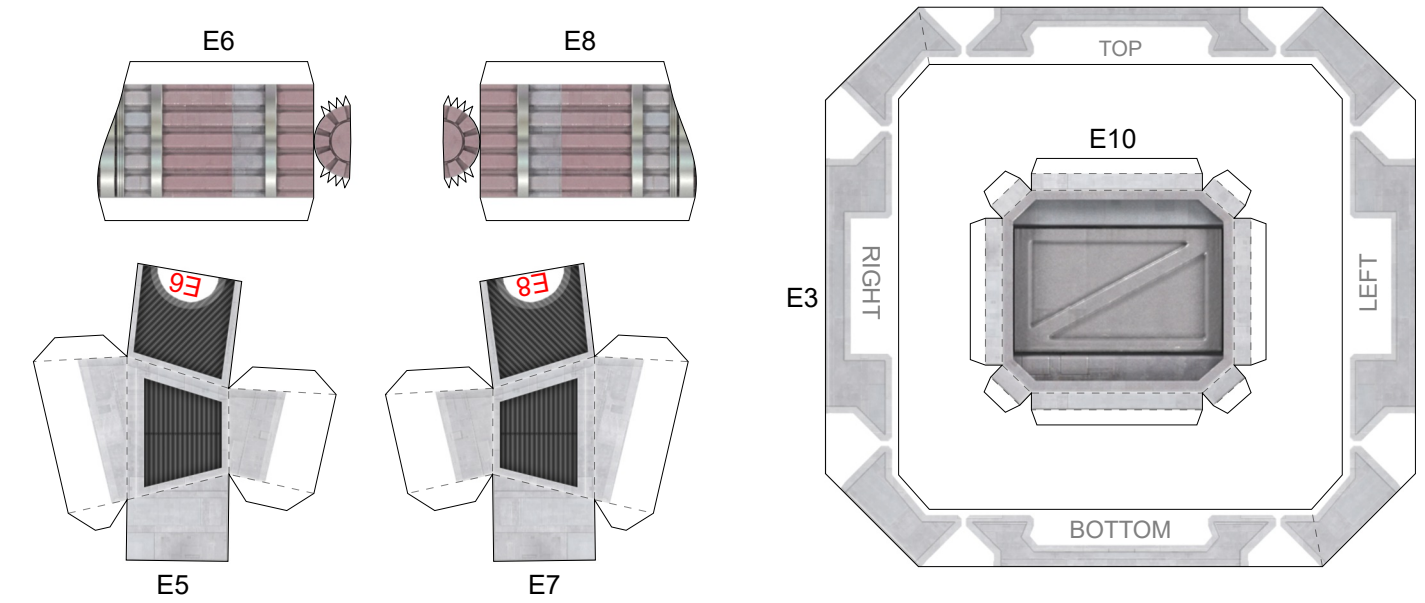
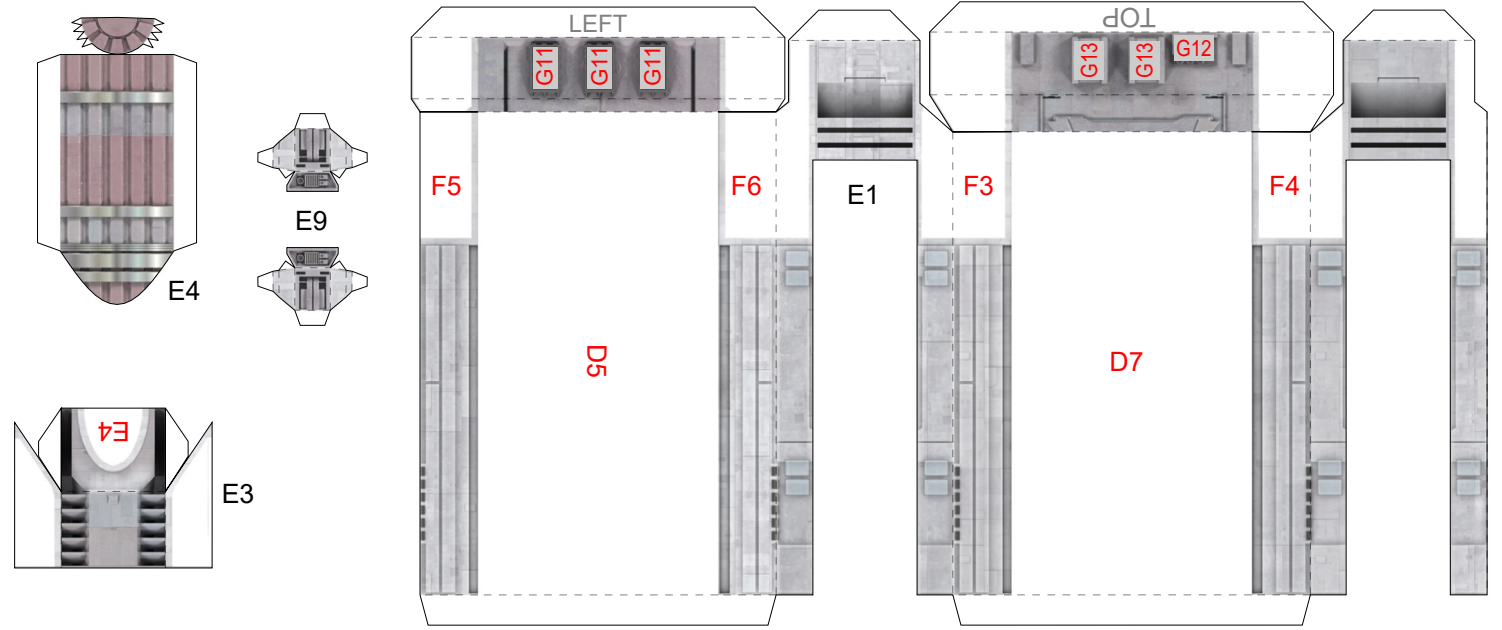

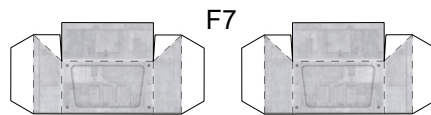
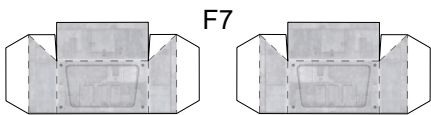
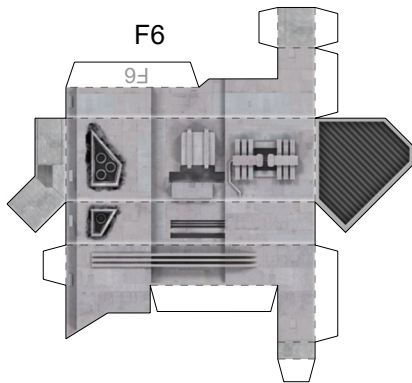
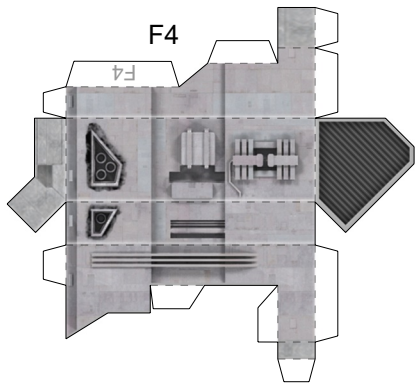
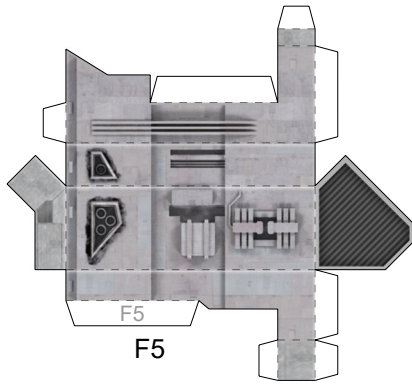
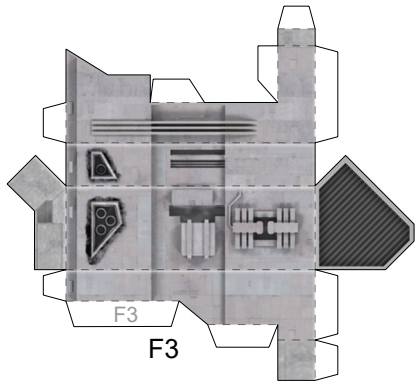
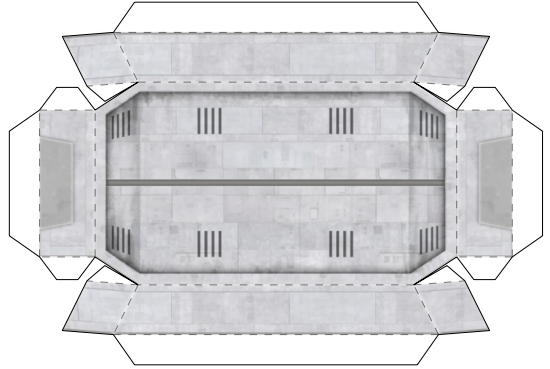
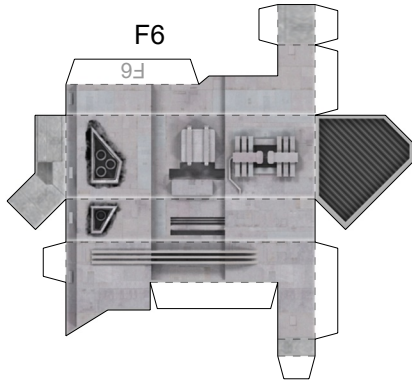
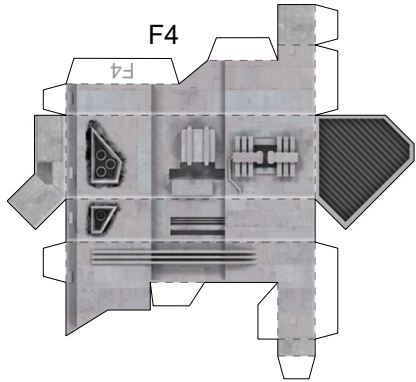
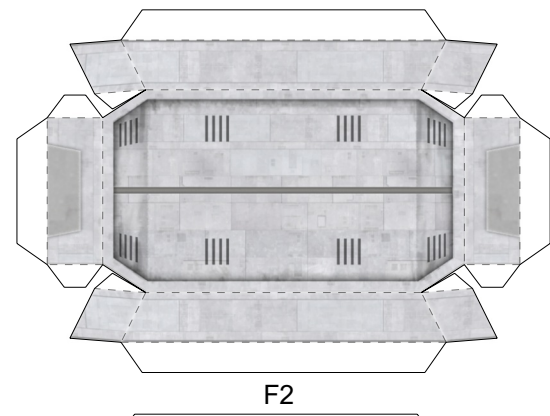
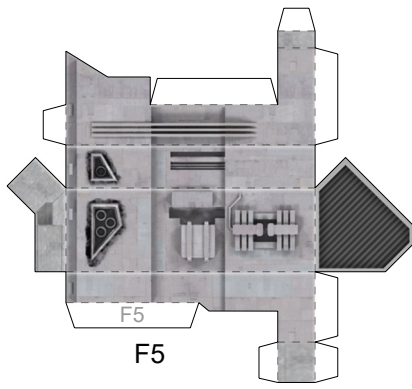
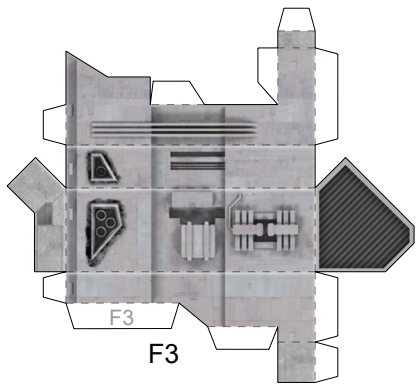

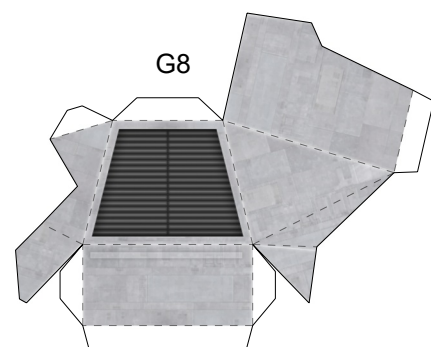
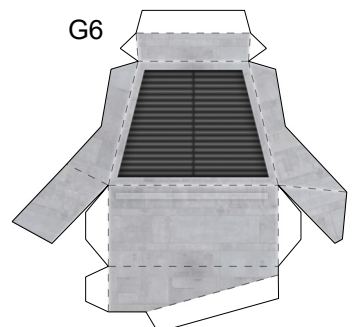
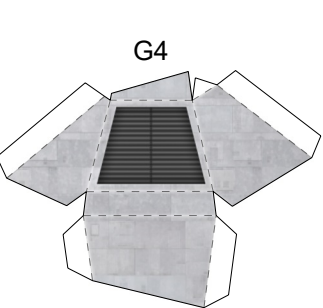
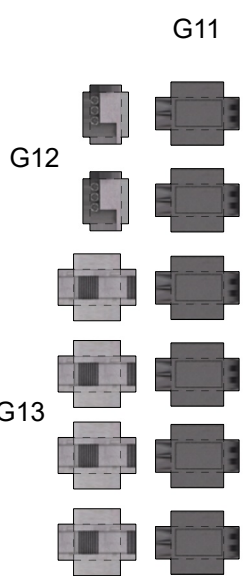
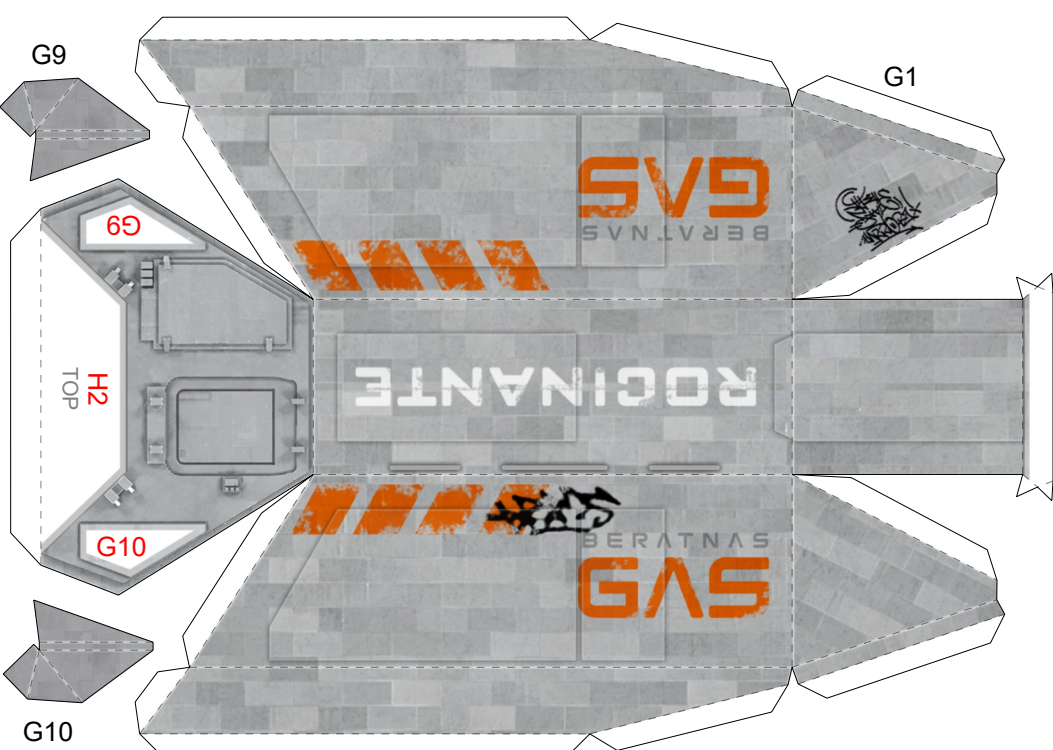
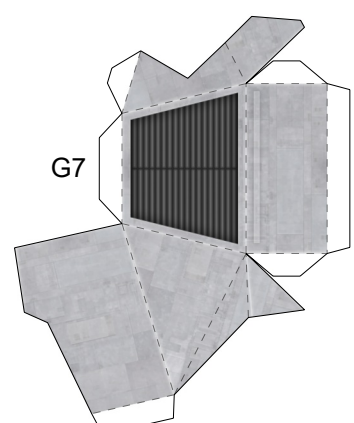
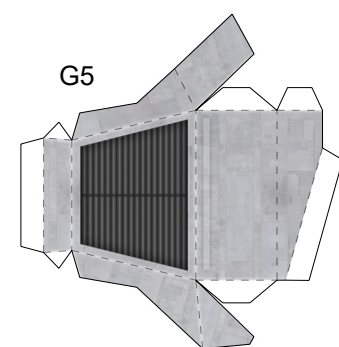
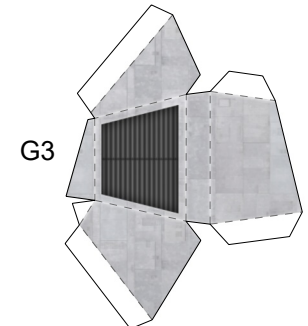
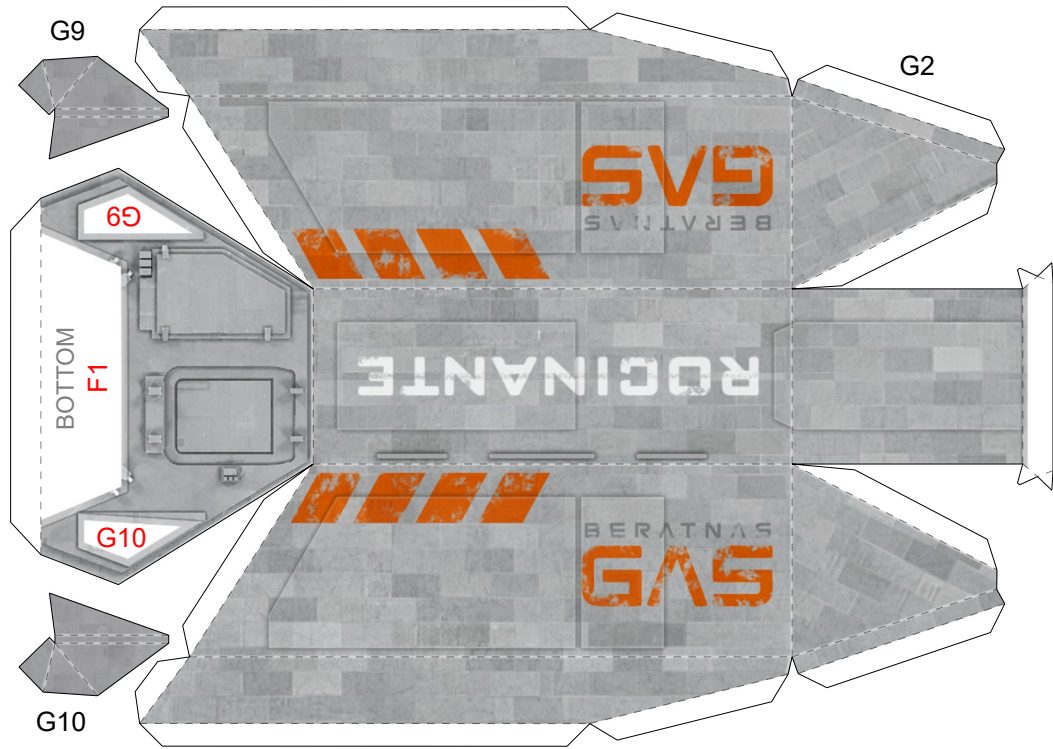

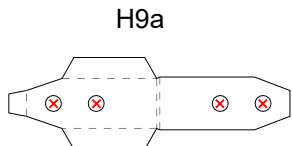
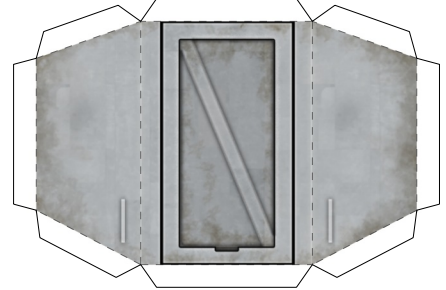
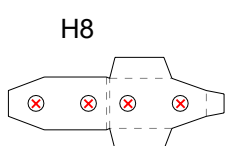
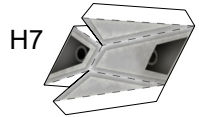
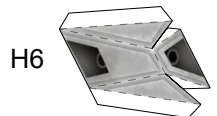
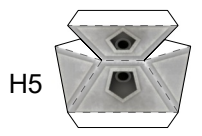
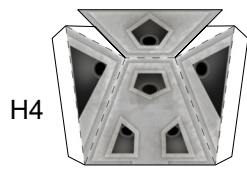
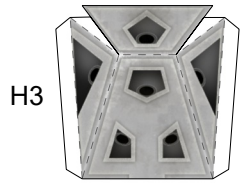
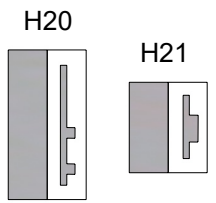
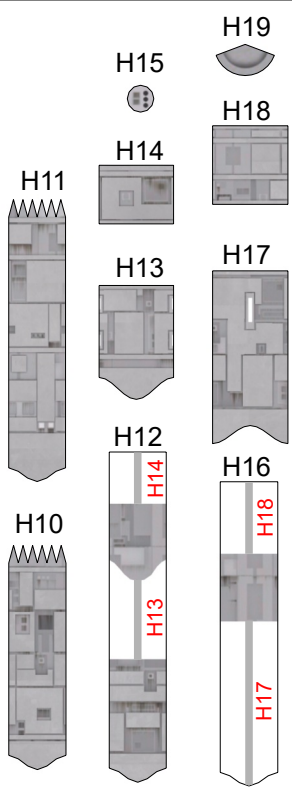

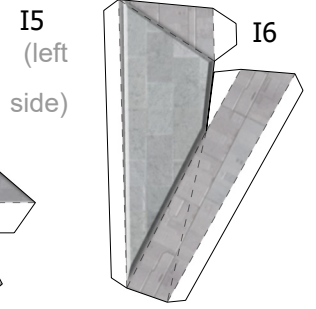
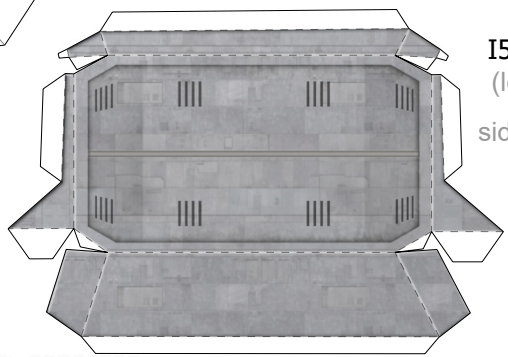
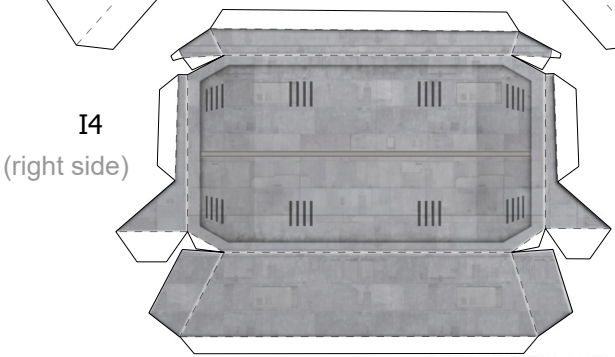
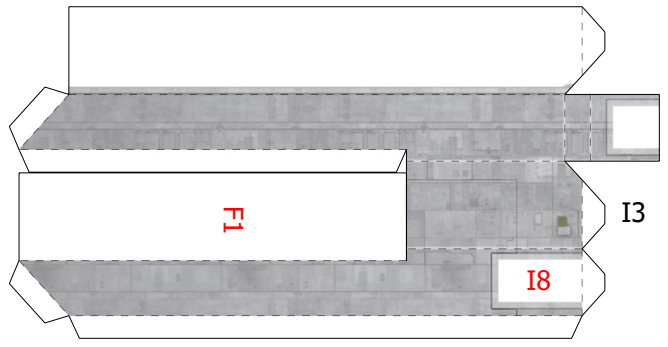
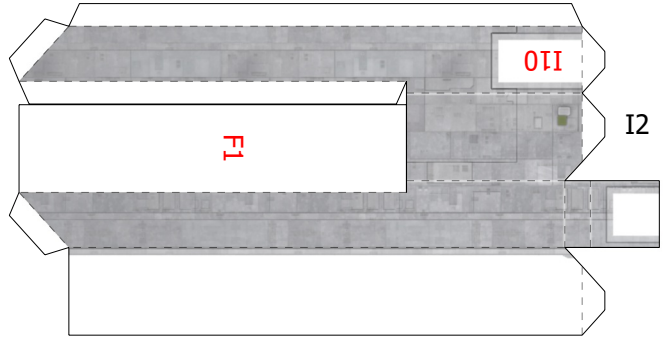
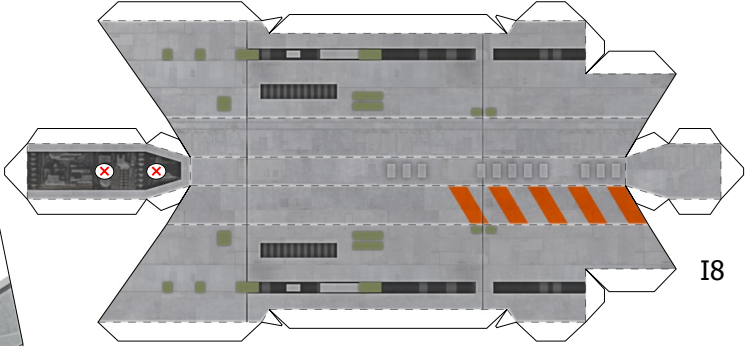
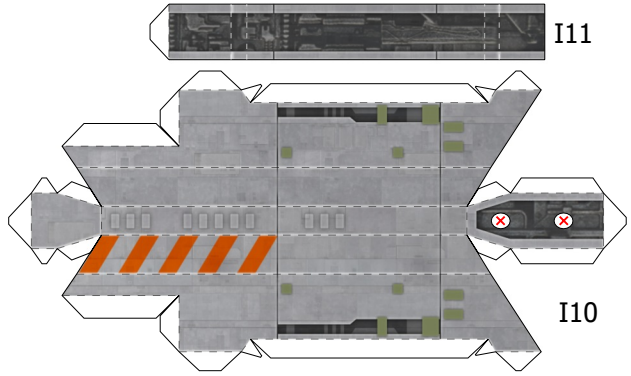
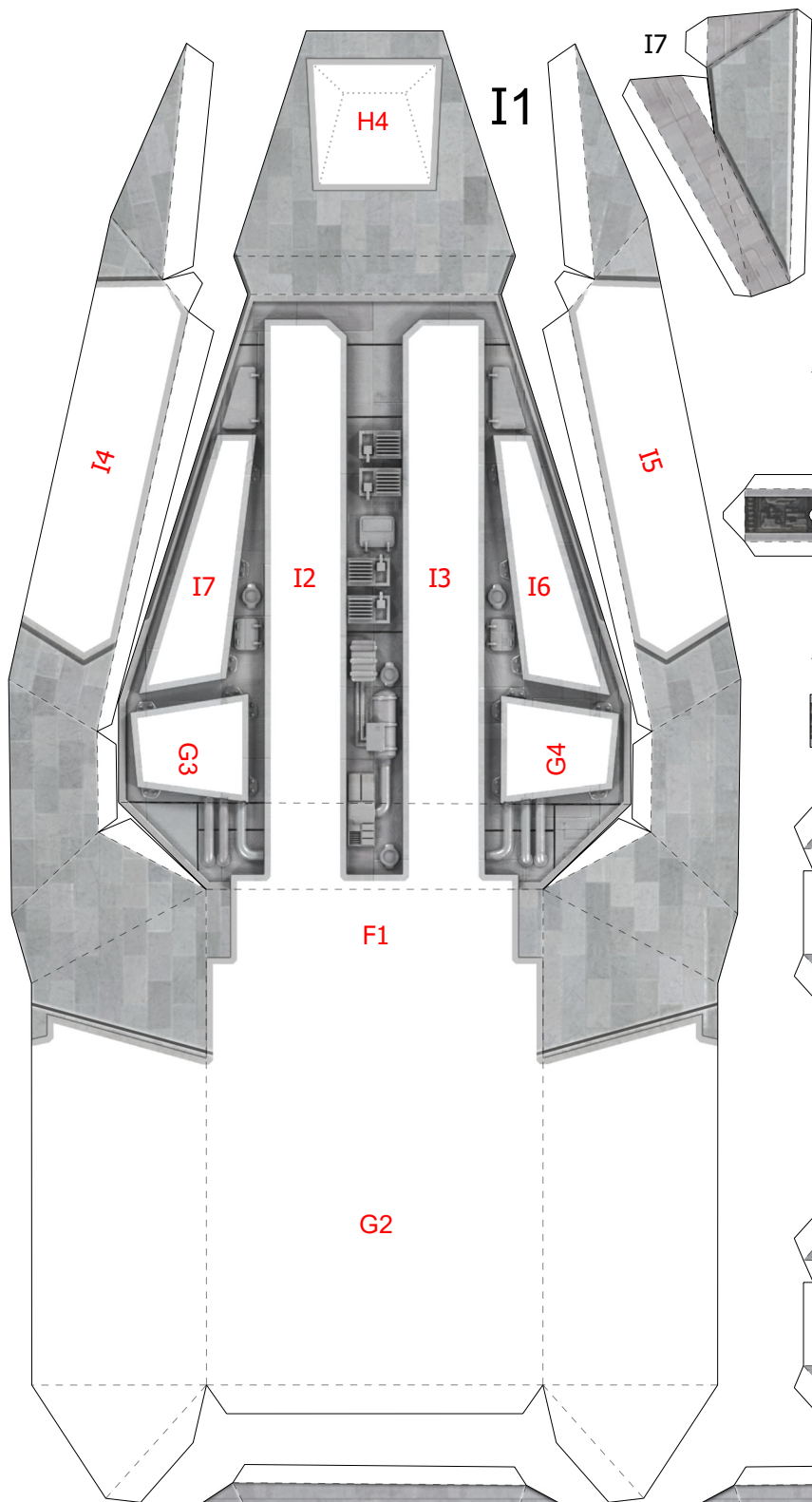

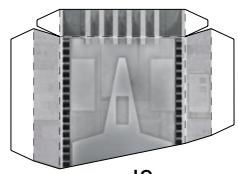
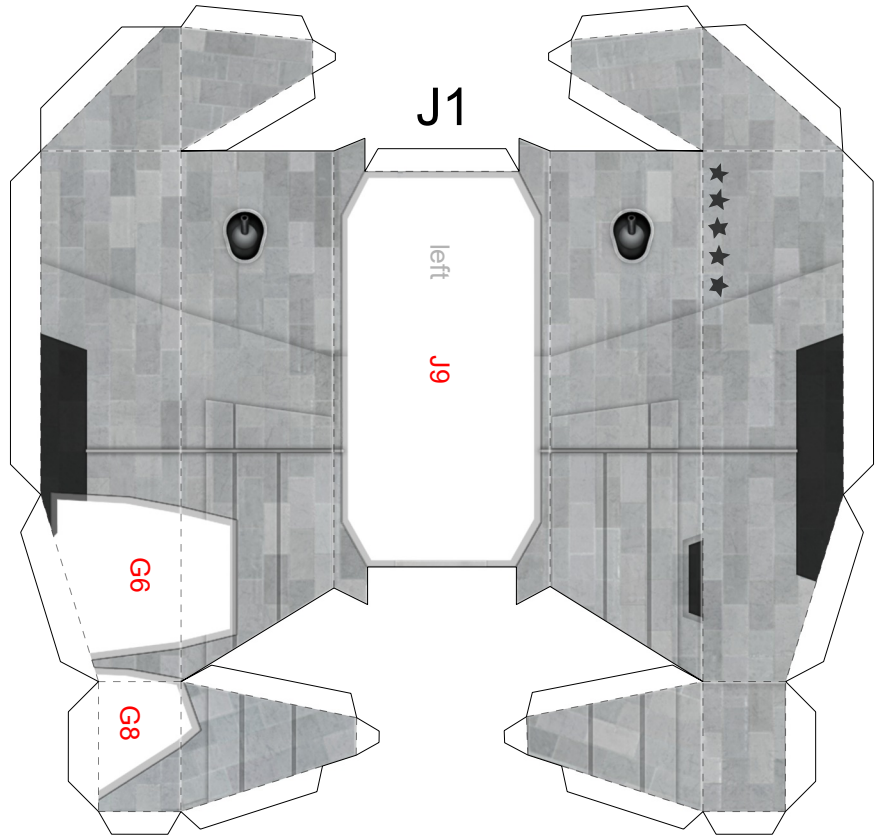

J8

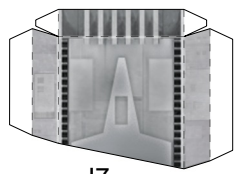

J7

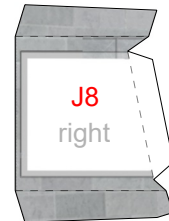
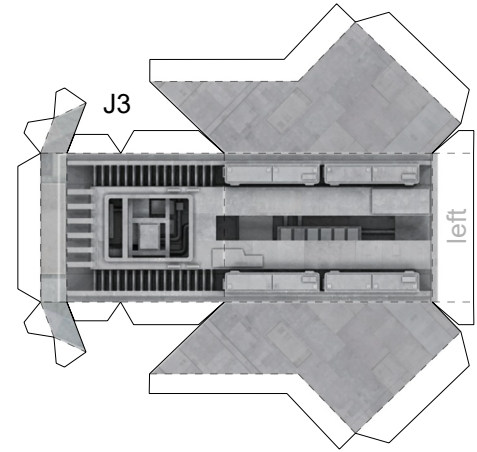
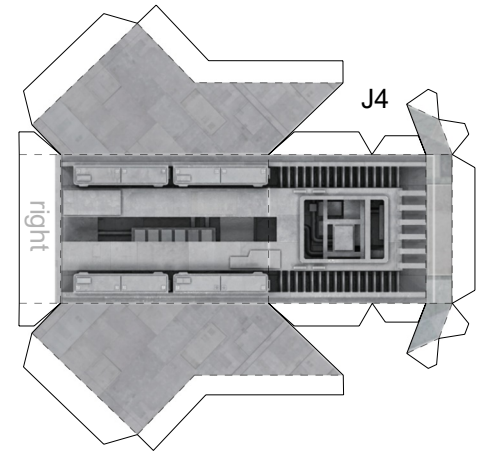
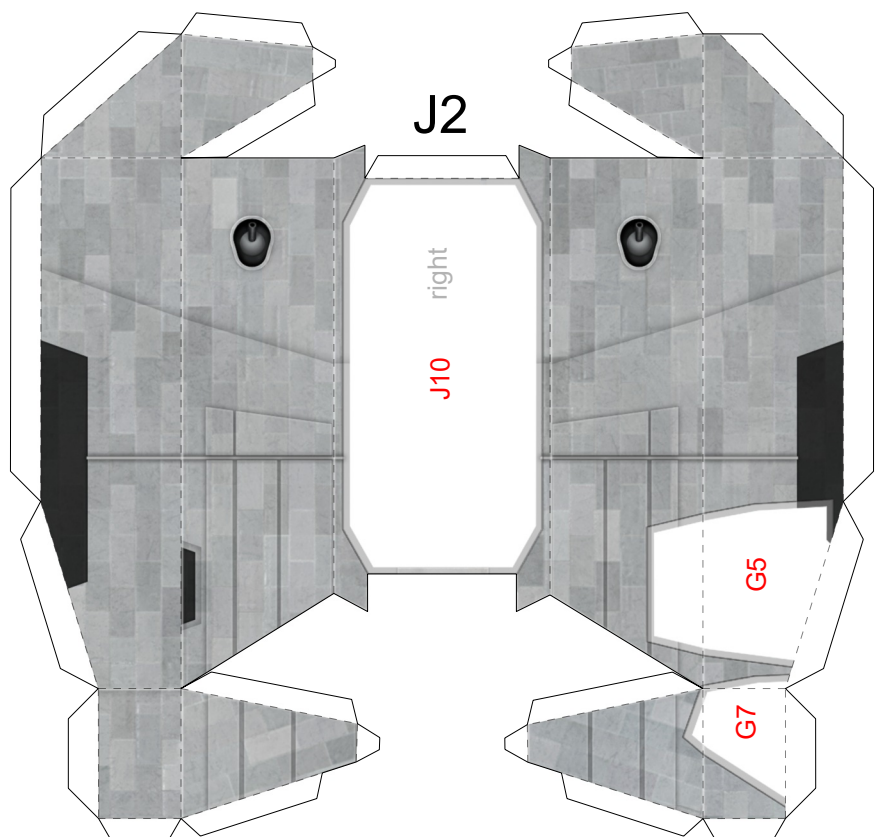

J6

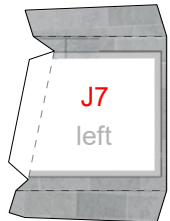

J5

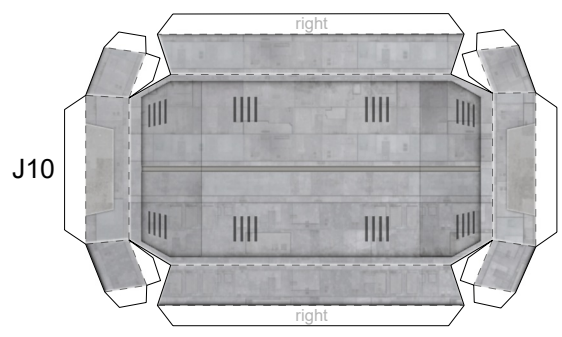
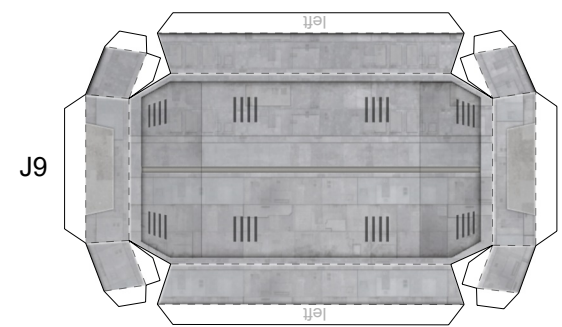

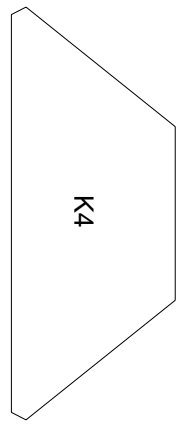
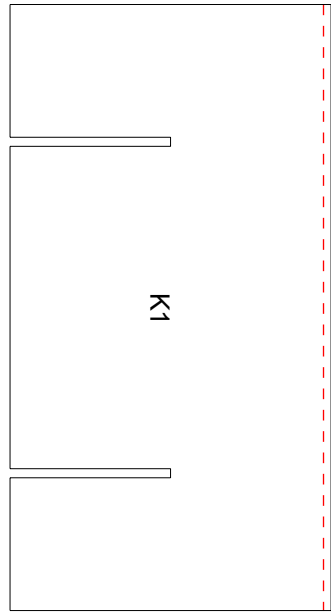
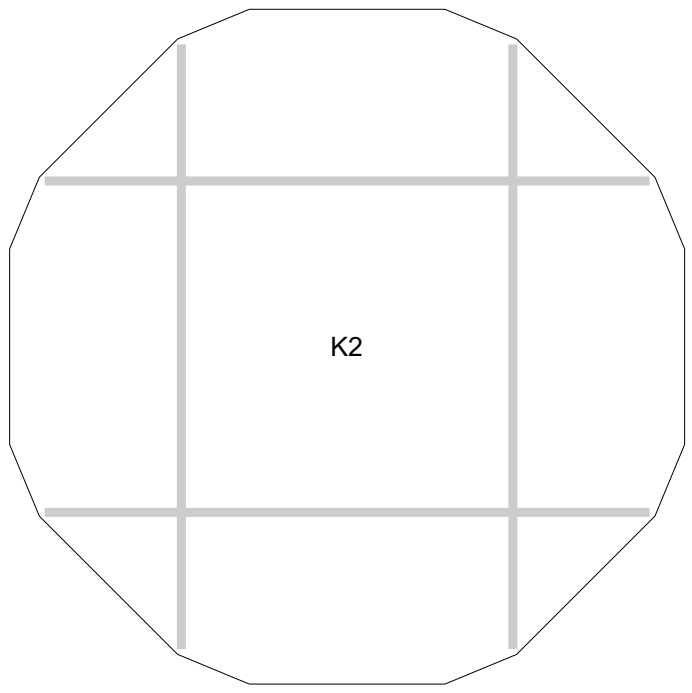
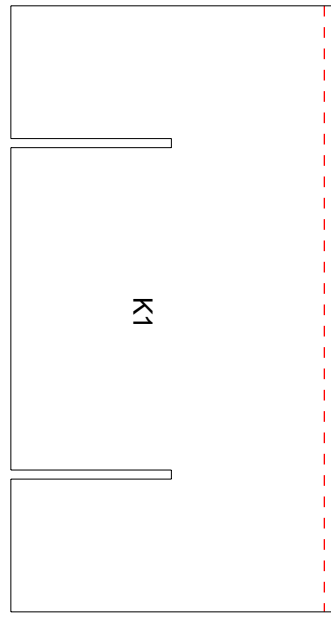
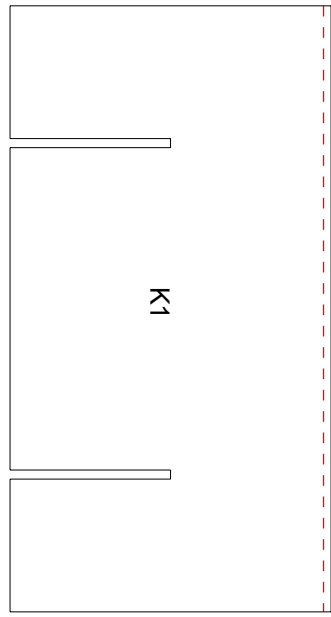
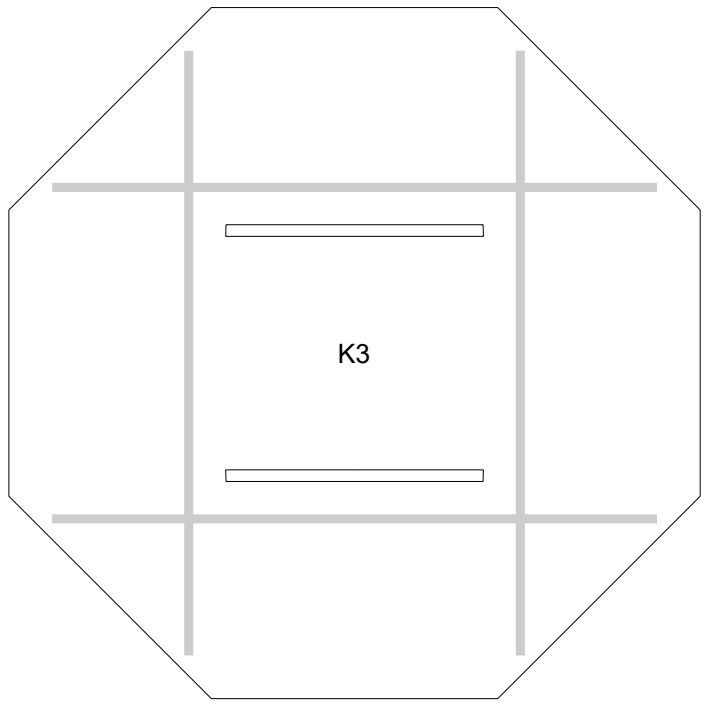
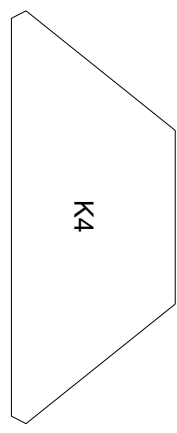
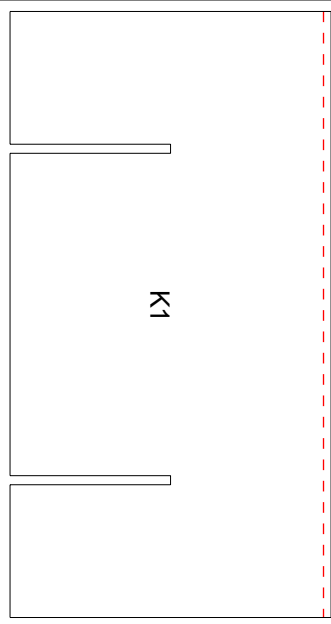

- - - - - cut here if using 1.5mm thick cardboard

L1
left/right

L1
left/right

L2
top/bottom

L2
top/bottom

L3

L4

top/bottom

top/bottom

left/right

left/right

left/right

left/right

top/bottom

top/bottom

M2

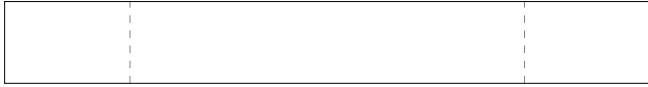

M2



M1

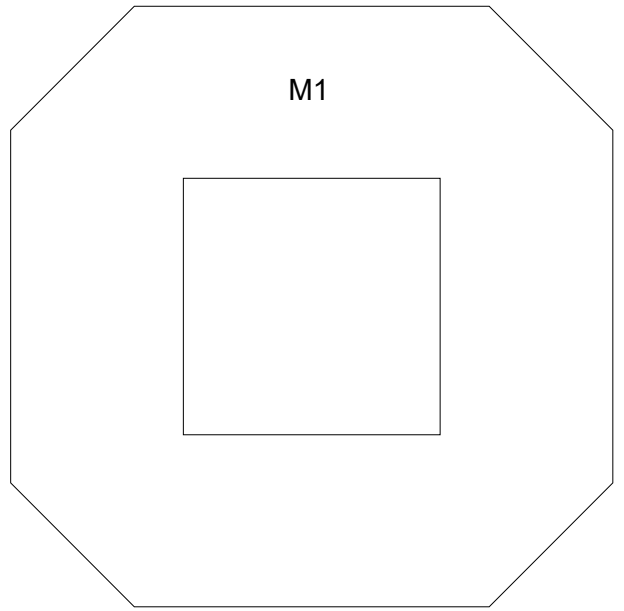

M8

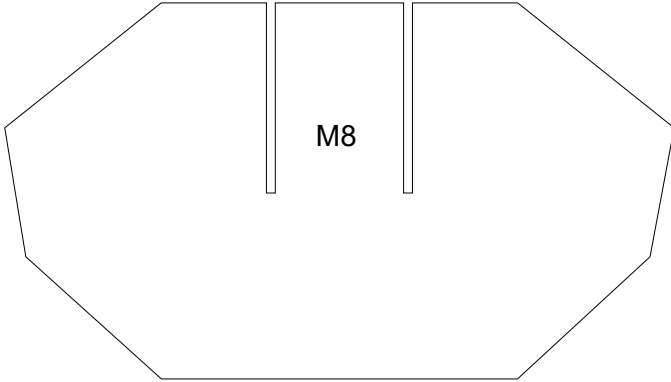

M9

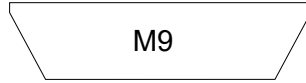

M9

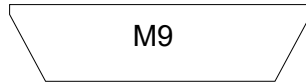

M10



M11



(top/bottom)

M4



M3

M5

M4

(top/bottom)

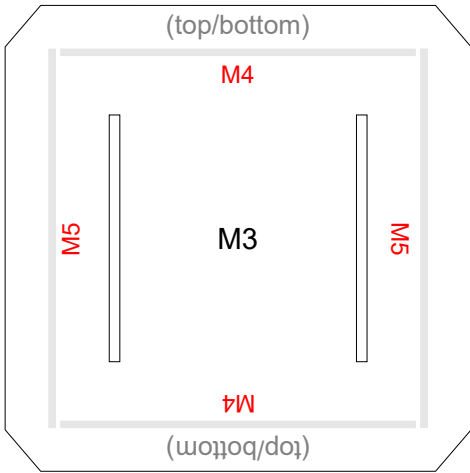

(top/bottom)

(top/bottom)

M7

M6

(top/bottom)

(top/bottom)

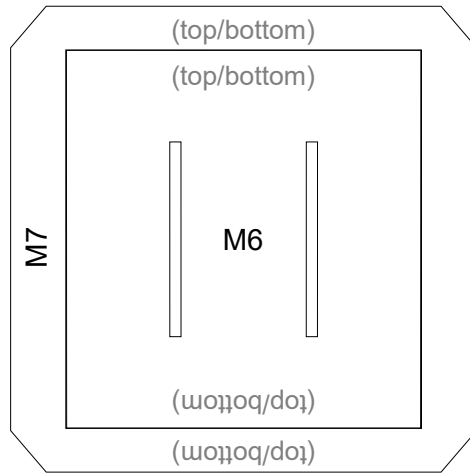

M6

M4
(top/bottom)

M7

M3

M6

M5
(left/right)

M7

M3

M6

M4
(top/bottom)

M7

M3

M6

M5
(left/right)

M7

M3

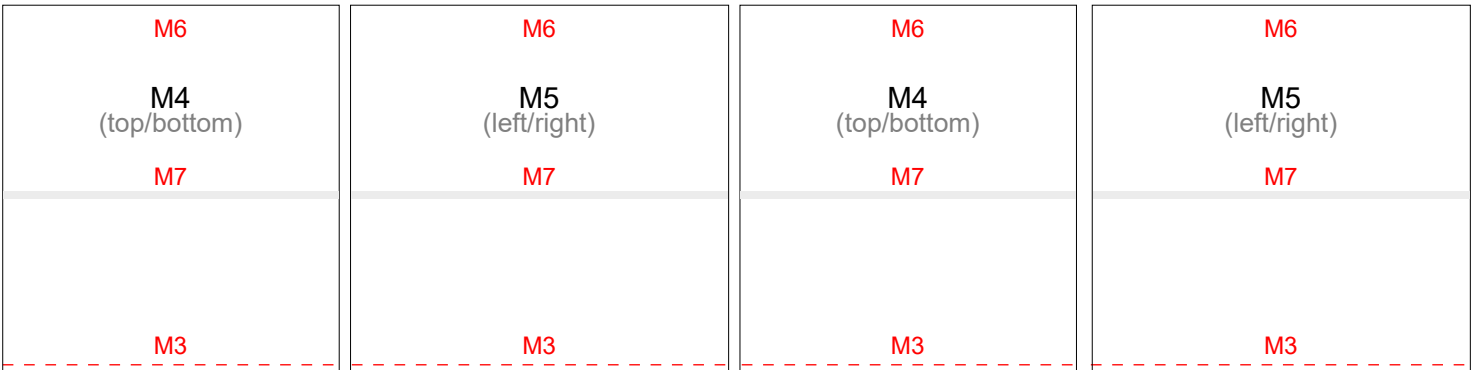

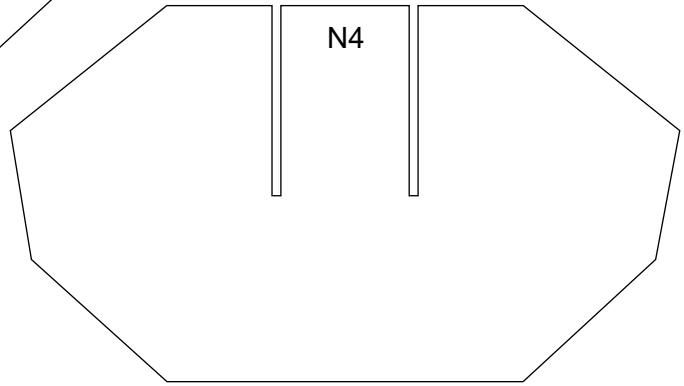
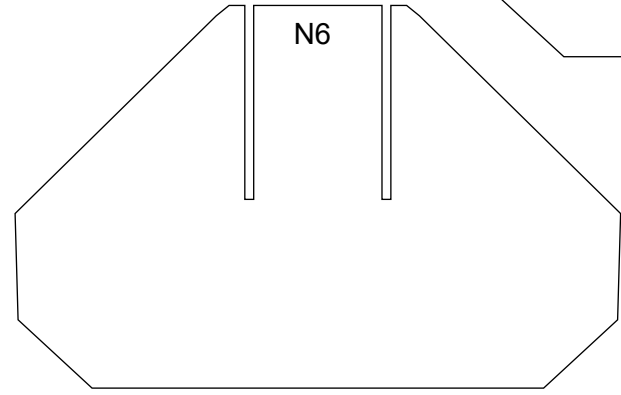
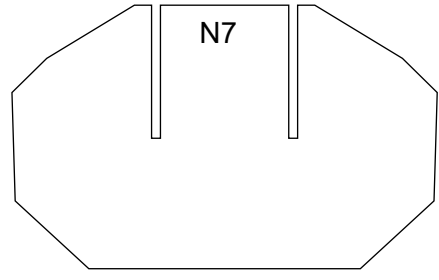
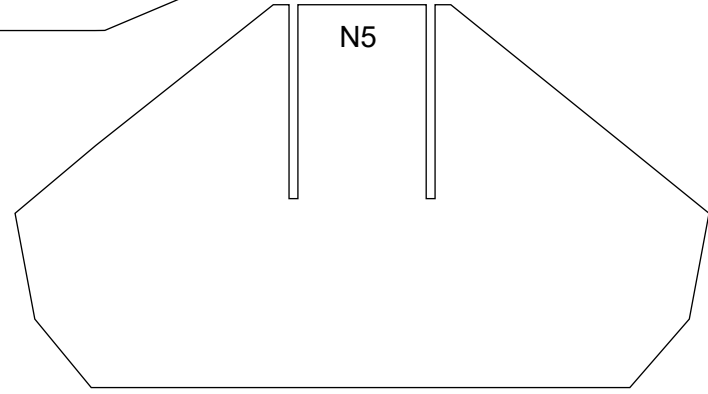
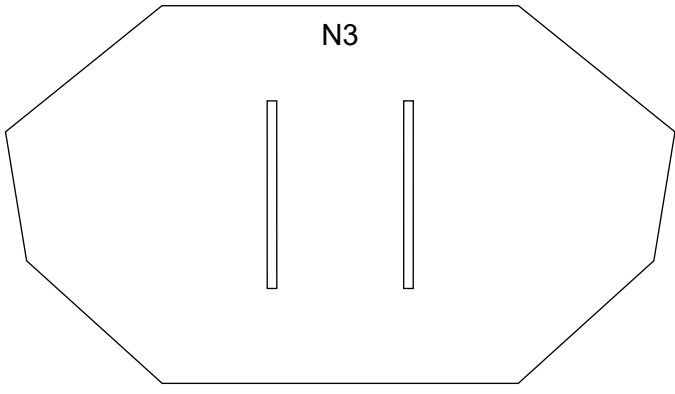
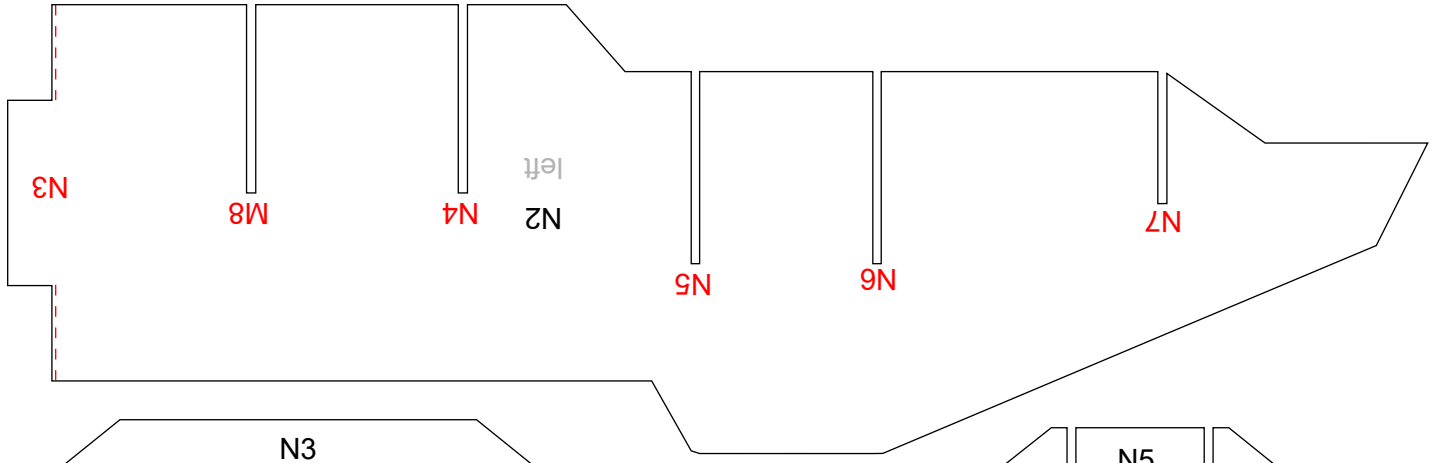
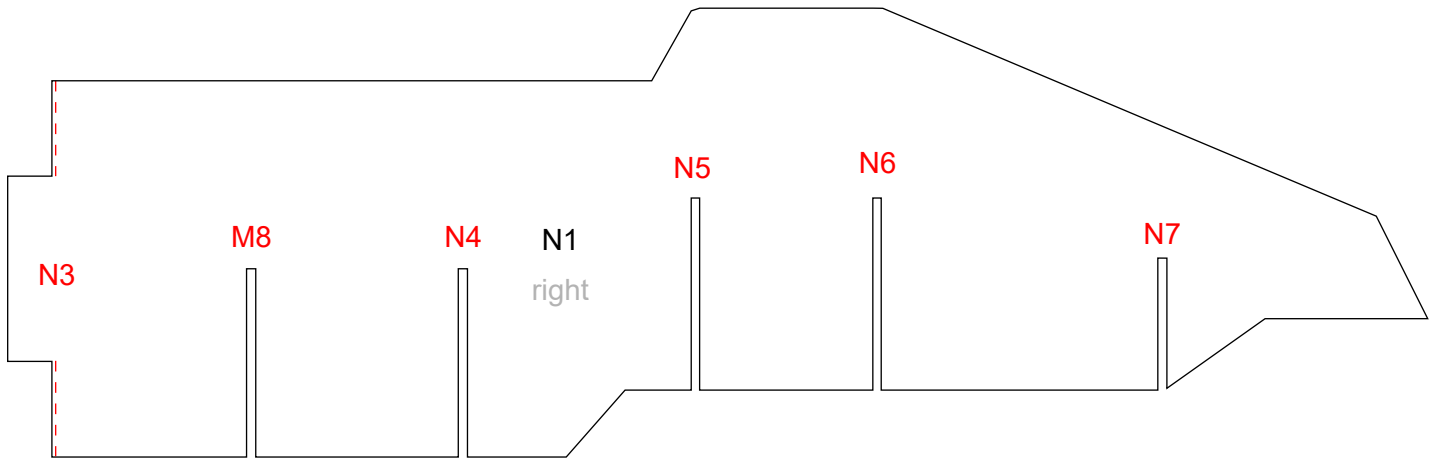

P19

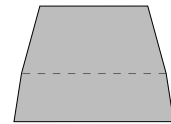

P18

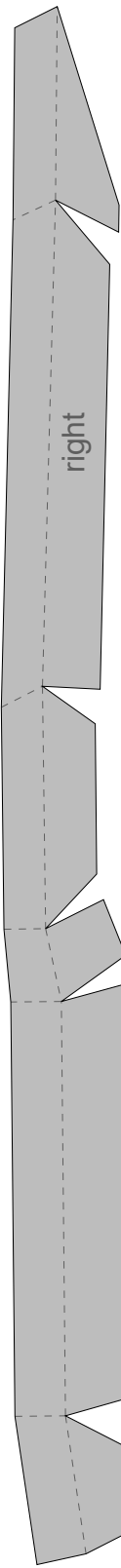

P17

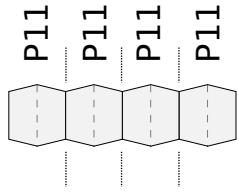
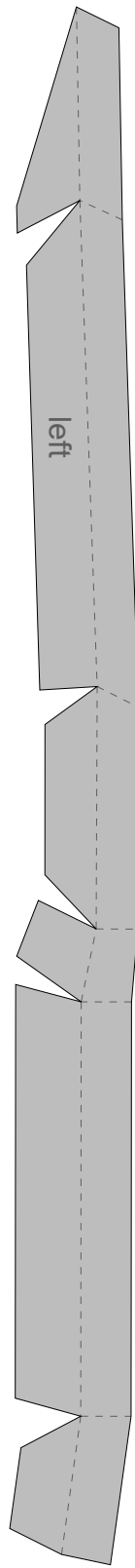

P11

P11

P11

P11

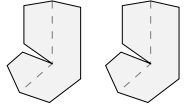

P12

P12

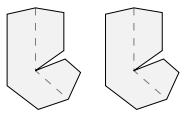

P13

P13

P14

P14

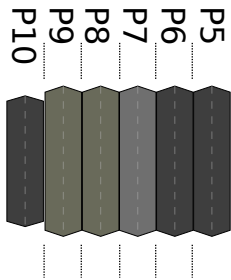
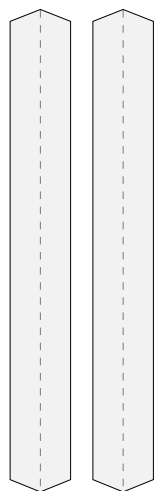

P10

P9

P8

P7

P6

P5

P16

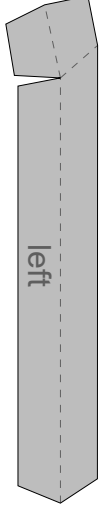

P15

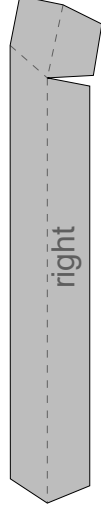

P1
P1
P1
P1
P1
P1
P1
P1
P1

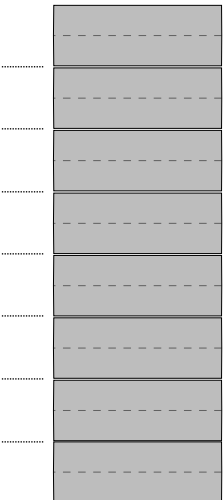

P4

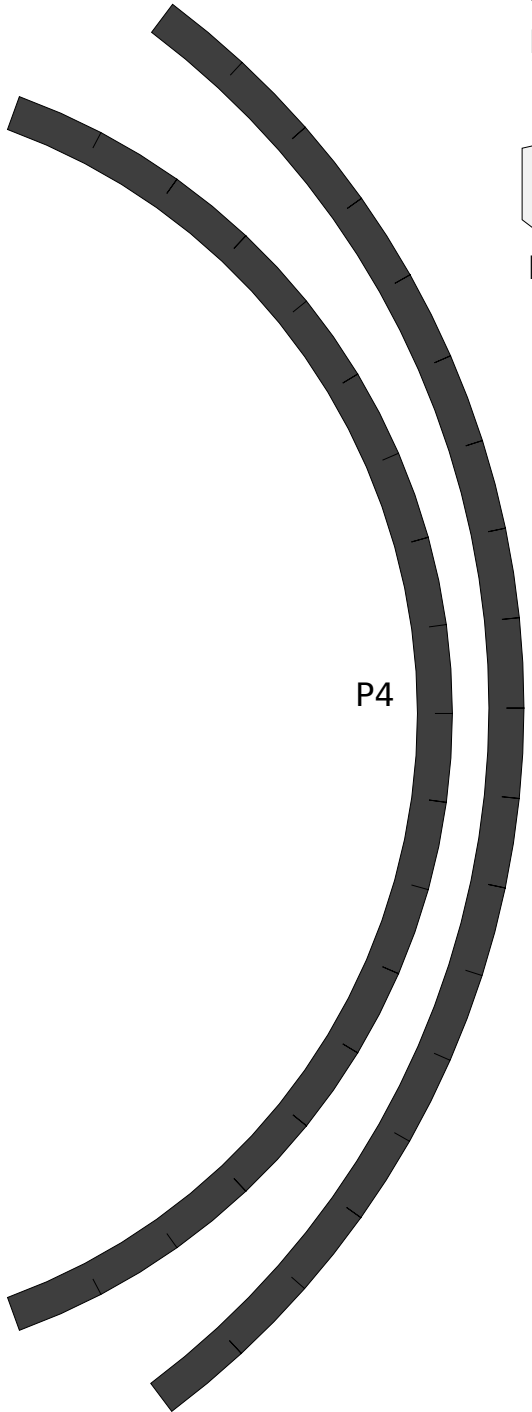

P3



P2



P2

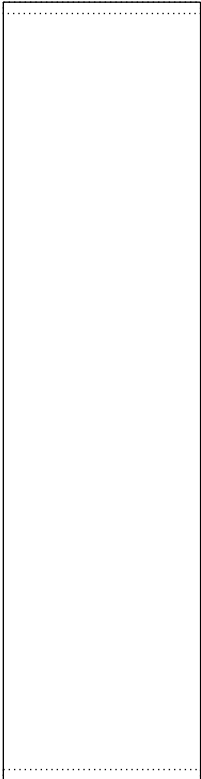

5

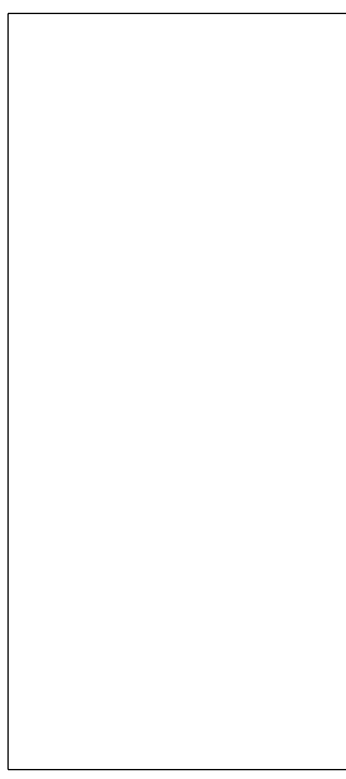

7

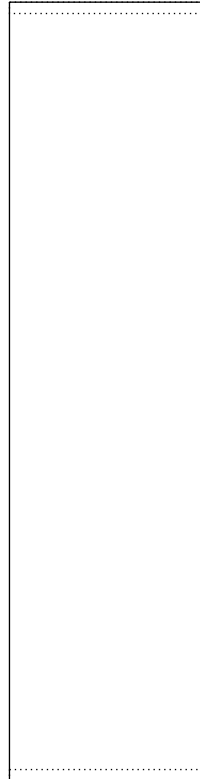

5

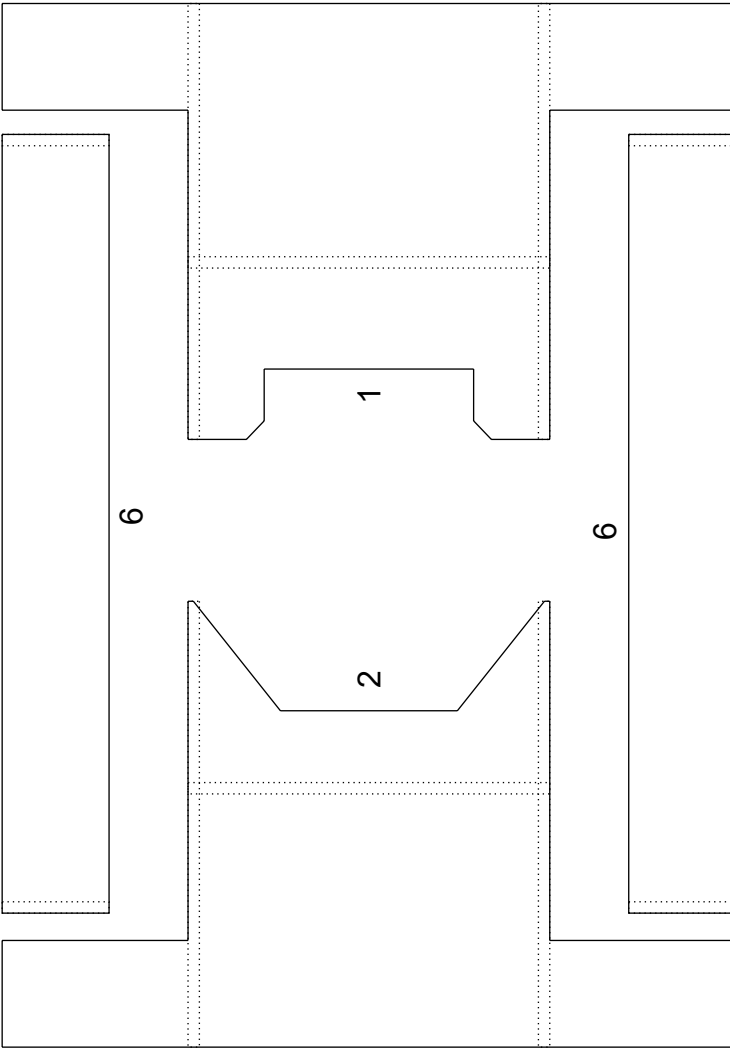

1

2

6

6

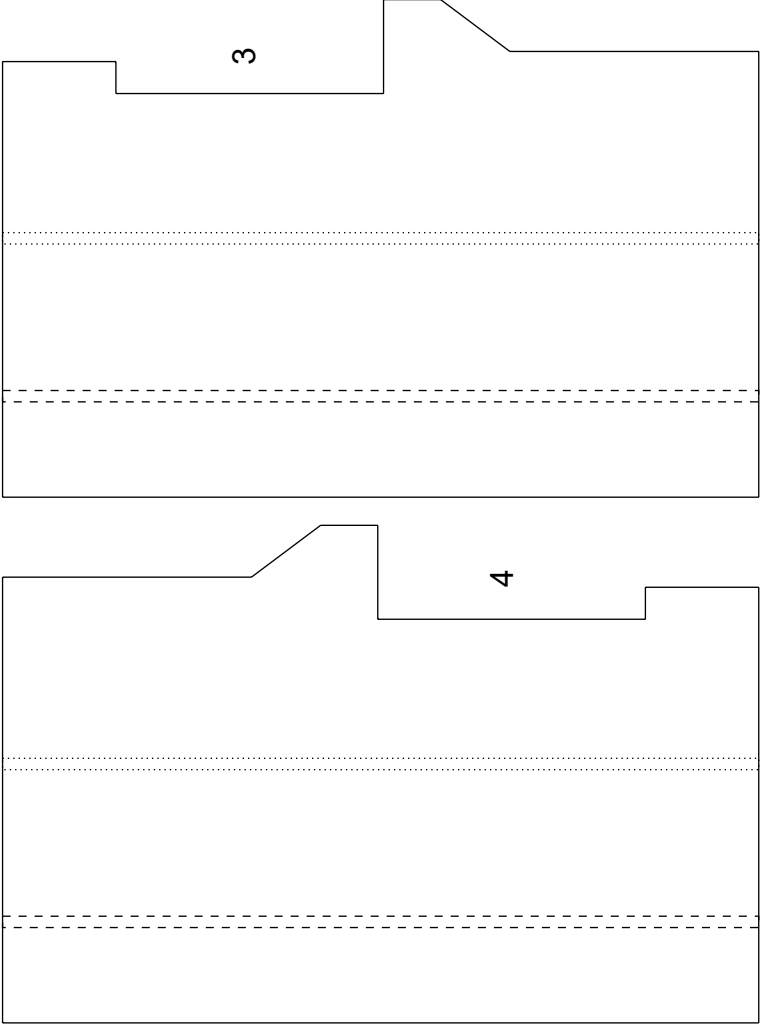

3

4

Parts 1-7:
 Cut from 1.5mm thick cardboard - - - - Apply glue on this side
 Apply glue on other side

THE
EXPANSE

Print on high-quality sticker / photo paper

ROCINANTE
 MCRN Corvette Class