

U-Boat Type VIIC 1/72 Scale

M

190 grms

1L

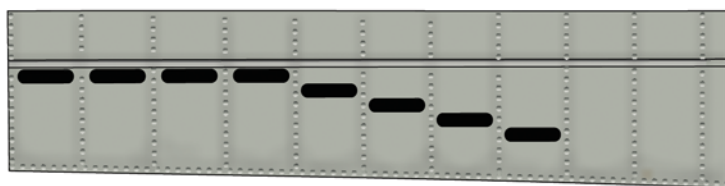

2L

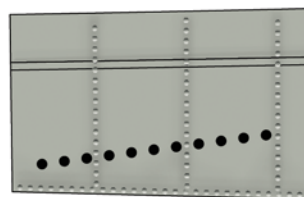

1R

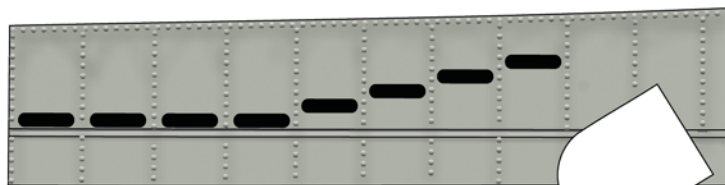

2R

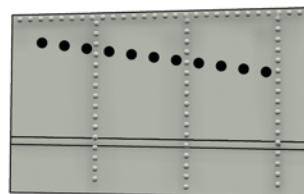

3



4



5

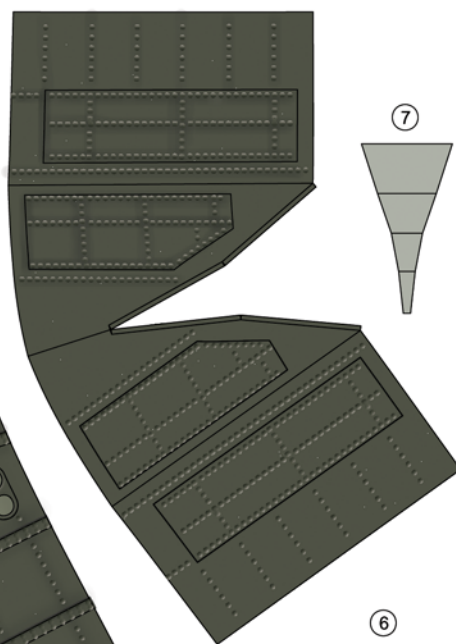

7

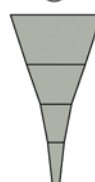

6

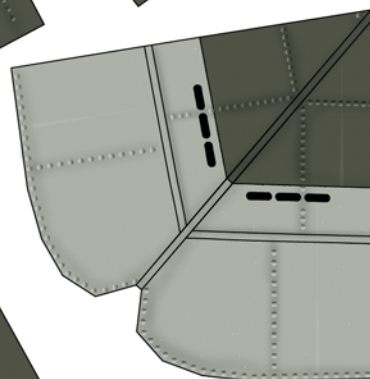

11



12L

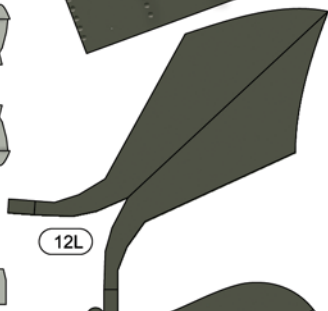

10



9



8

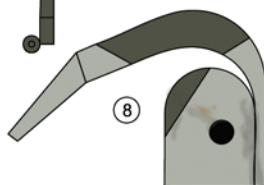

13L

13R

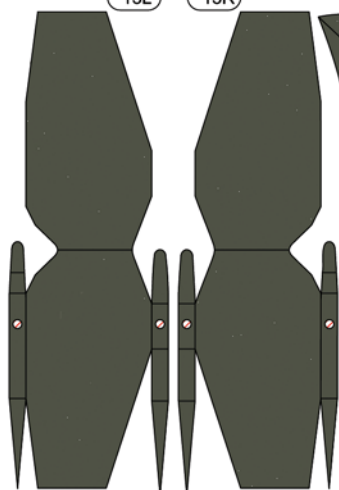

12R

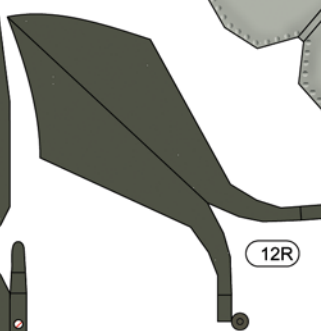

14



U-Boat Type VIIC 1/72 Scale

M

190 grms

1L



2L

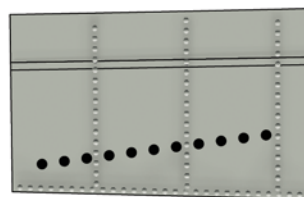

1R



2R

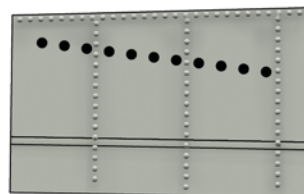

3



4



5

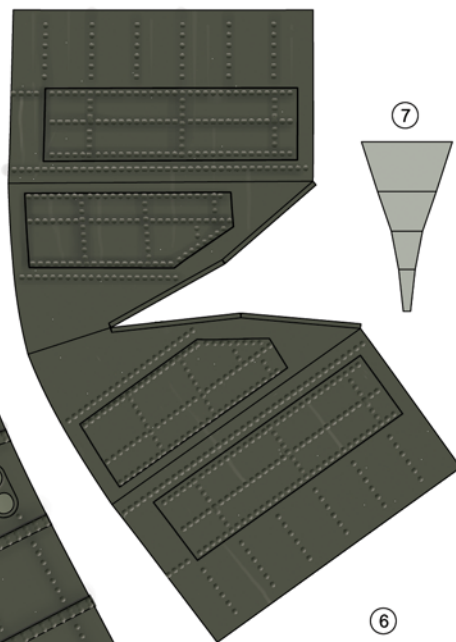

7

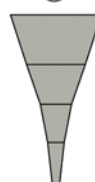

6

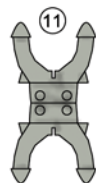
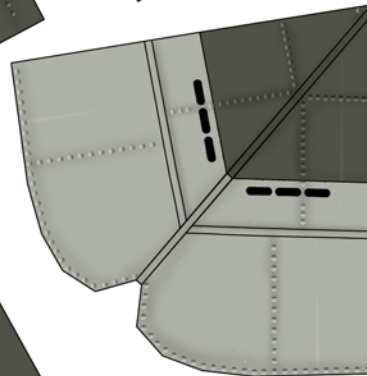

11

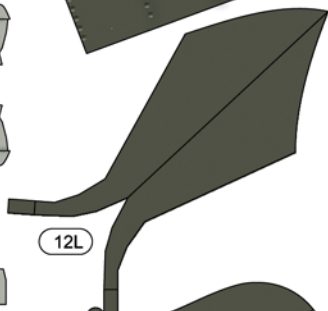

12L



10



9

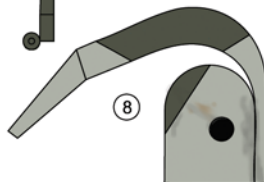

8

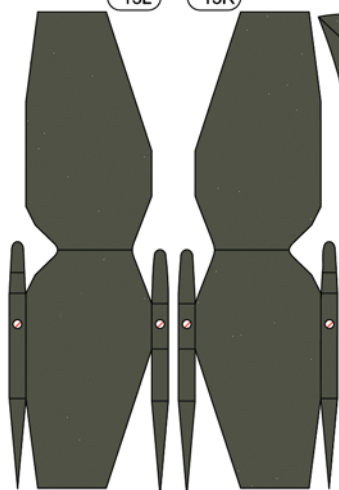

13L

13R

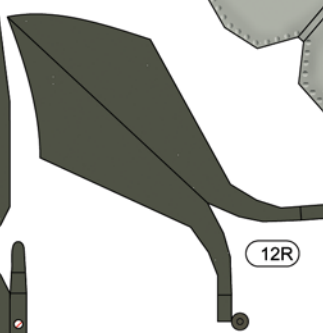

12R

U-Boat Type VIIC 1/72 Scale

0

190 grms

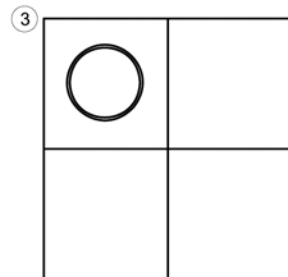
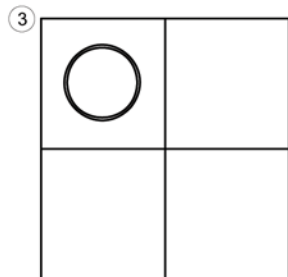
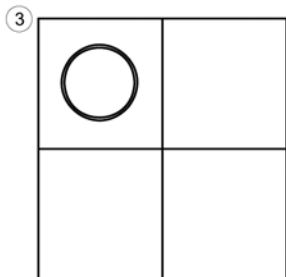
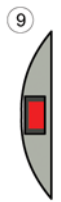
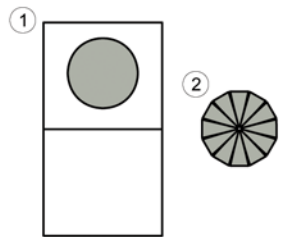
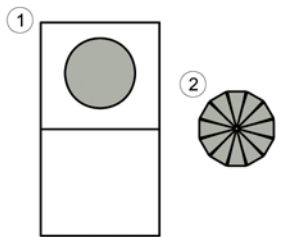
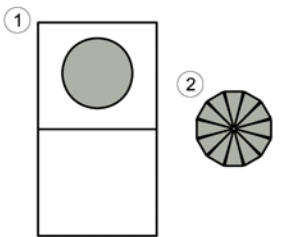
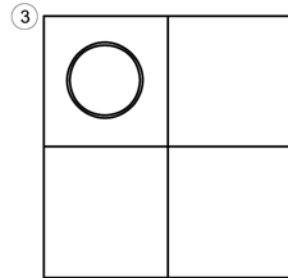
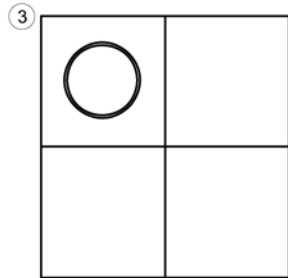
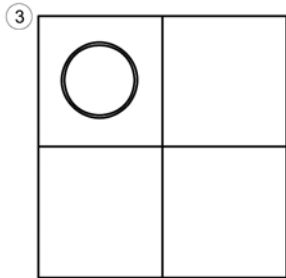
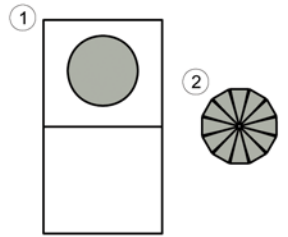
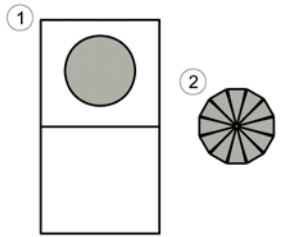
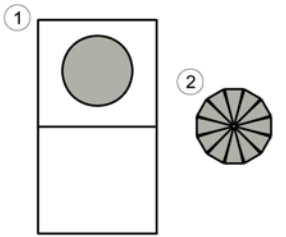
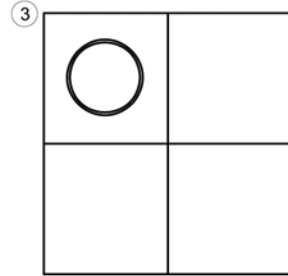
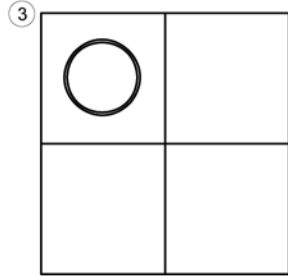
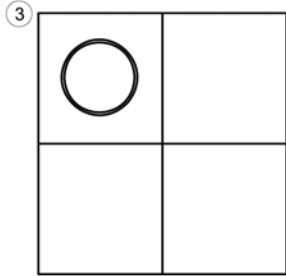
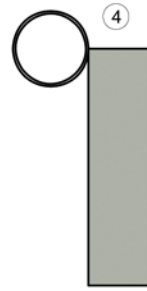
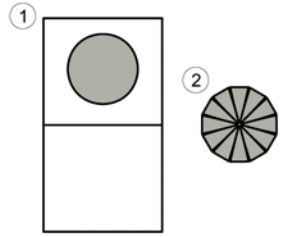
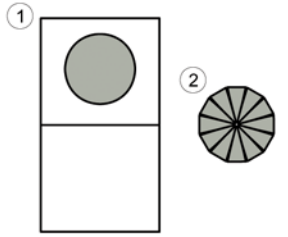
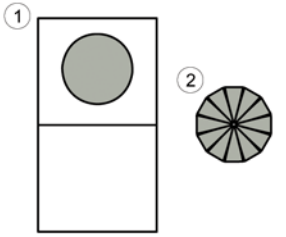

①

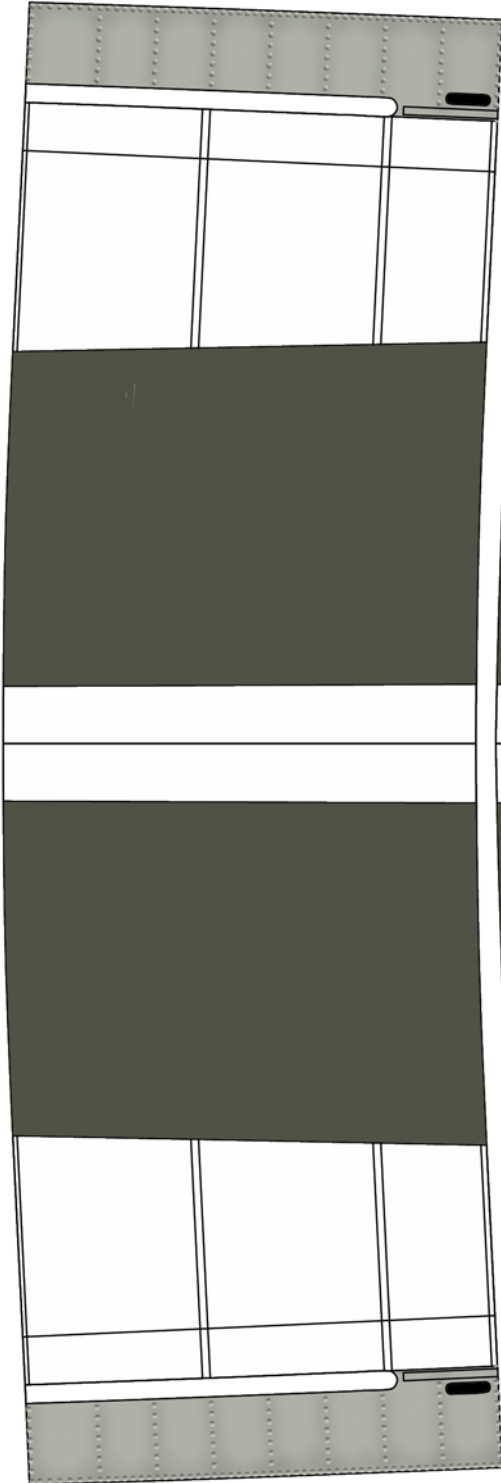

②

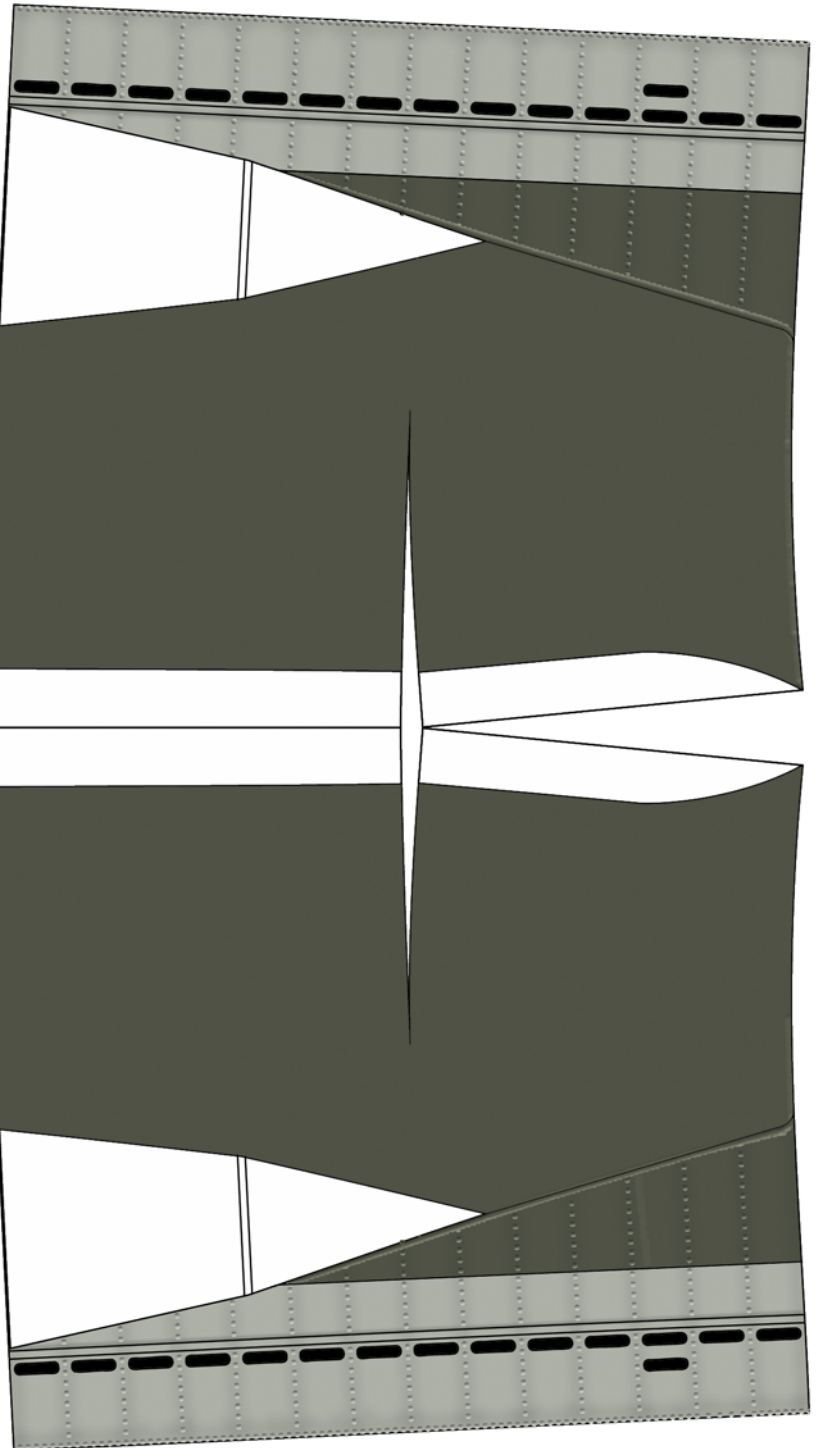

U-Boat Type VIIC 1/72 Scale

Q

190 grms

5L 4L 3L 2L 1L

1R 2R 3R 4R 5R

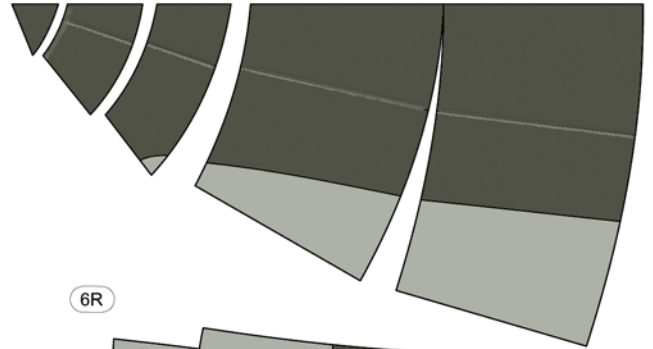
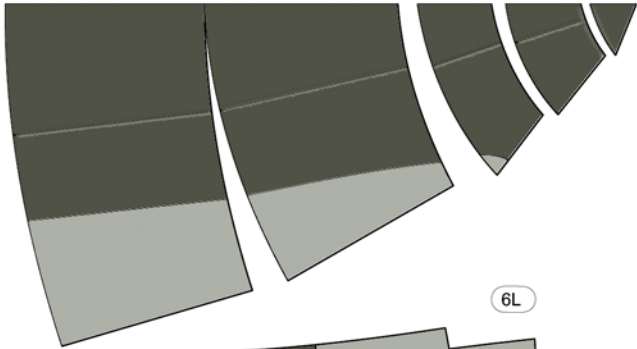

6L

6R

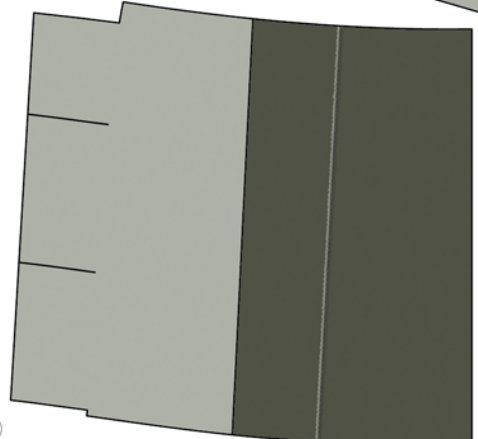
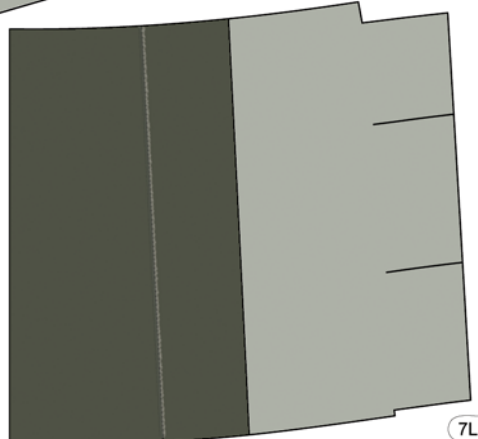

7L

7R

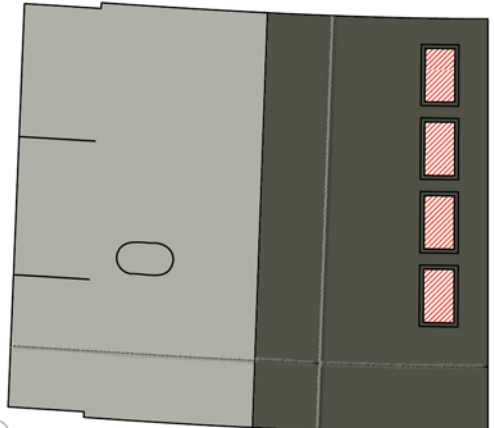
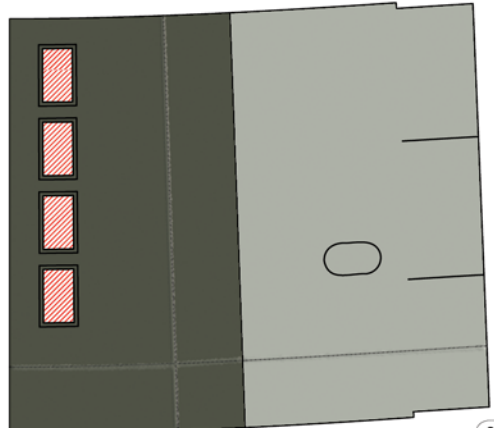

8L

8R

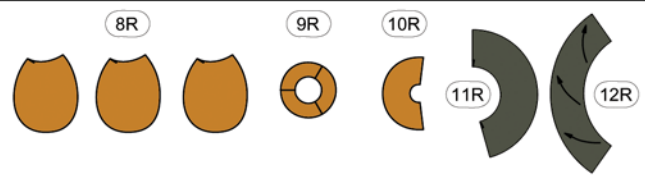
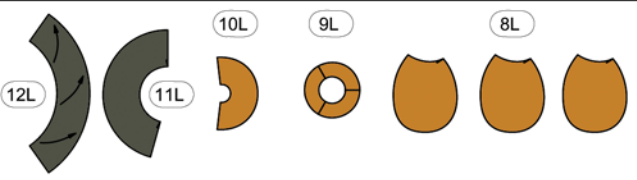
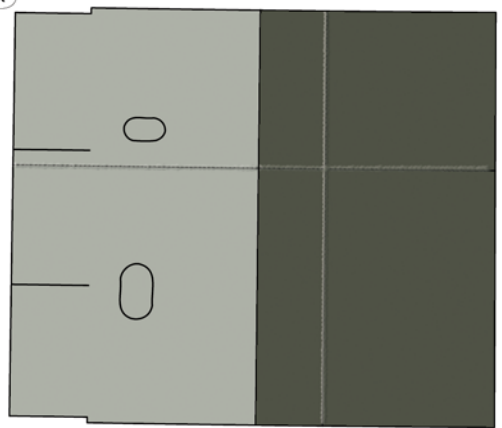
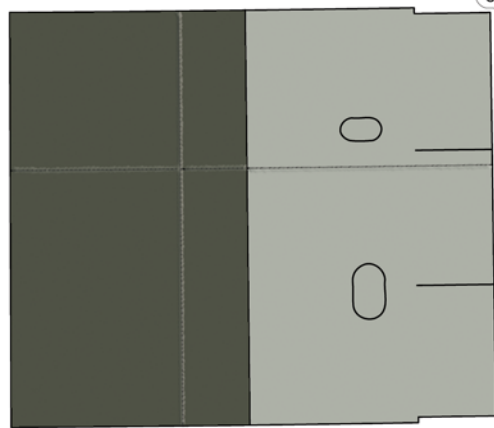

U-Boat Type VIIC 1/72 Scale

Q

190 grms

5L 4L 3L 2L 1L

1R 2R 3R 4R 5R

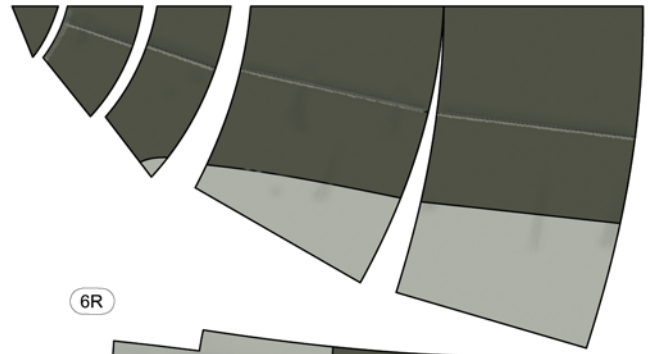
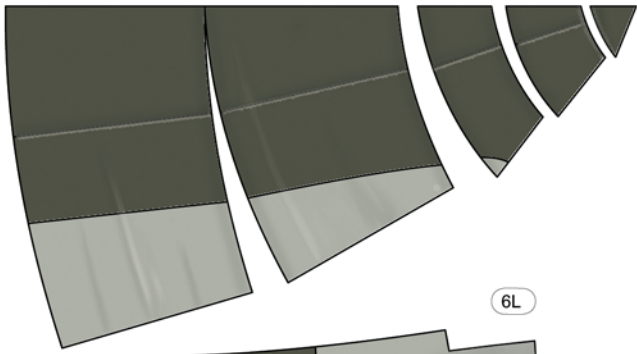

6L

6R

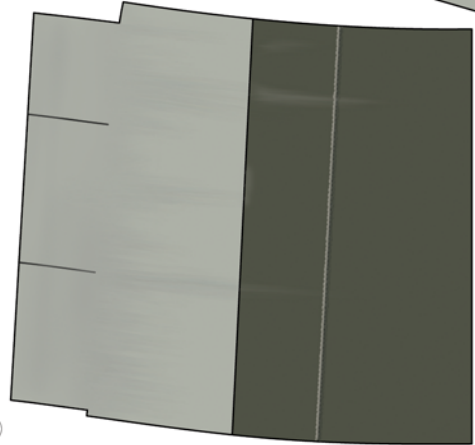
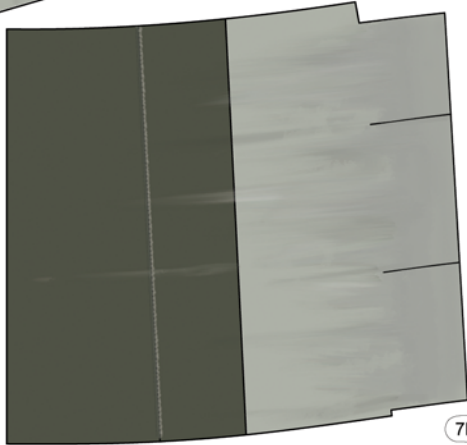

7L

7R

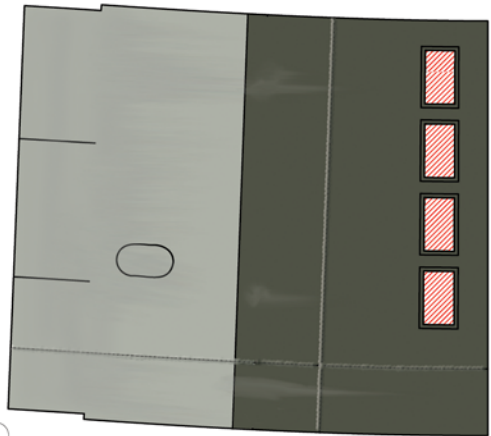
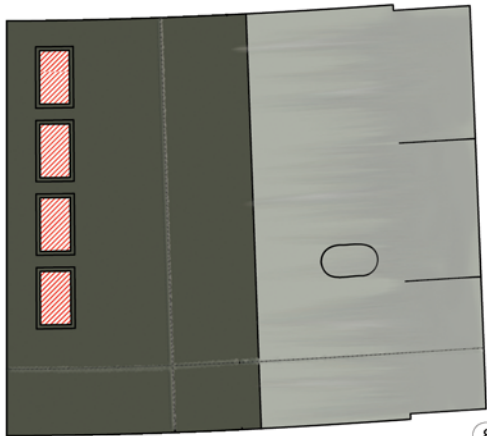

8L

8R

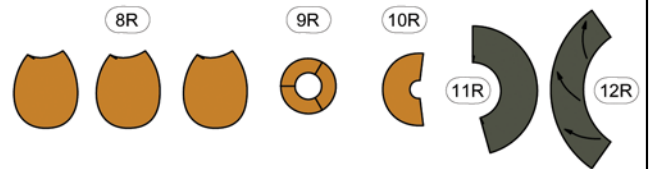
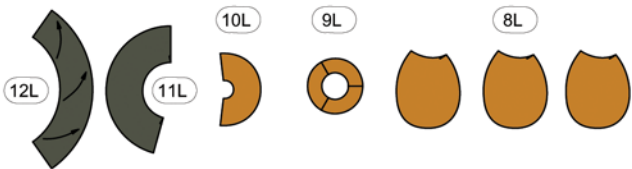
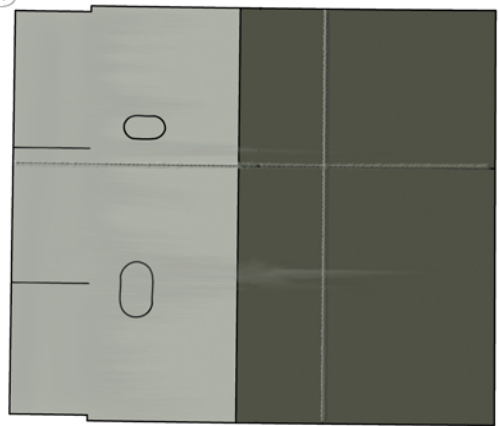
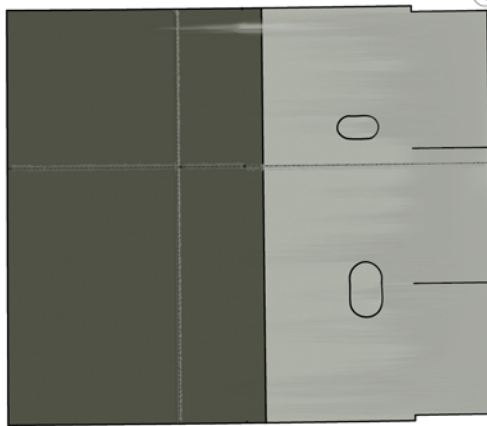

U-Boat Type VIIC 1/72 Scale

Q

190 grms

5L

4L

3L

2L

1L

1R

2R

3R

4R

5R

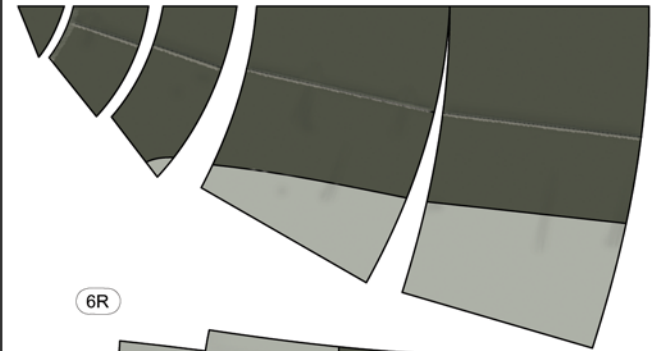
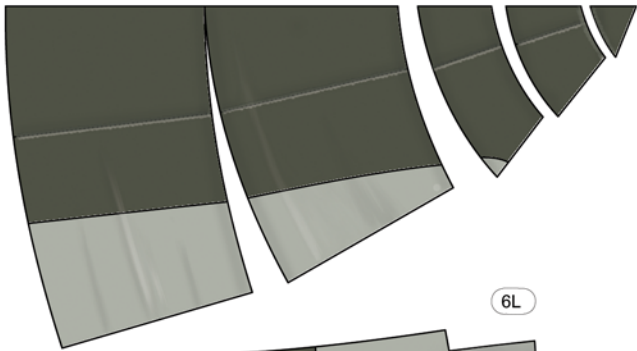

6L

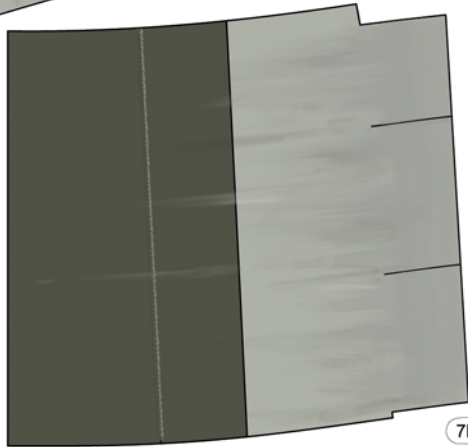

6R

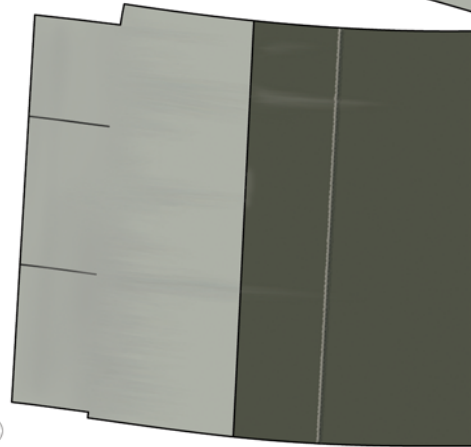

7L

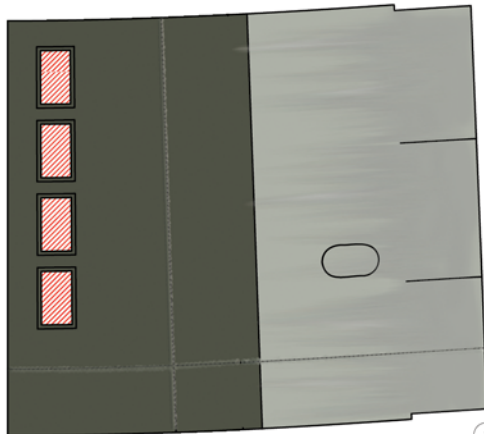

7R

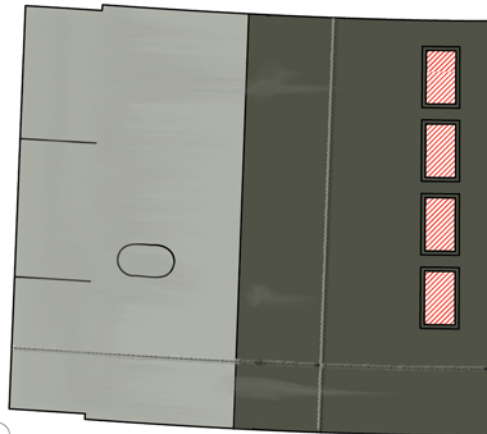

8L

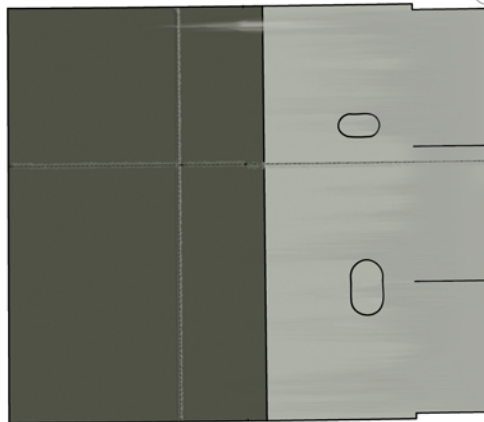

8R

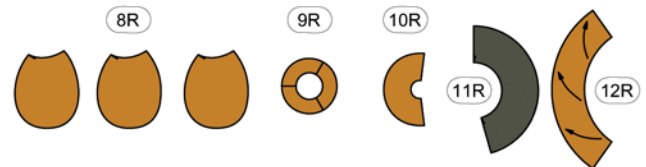
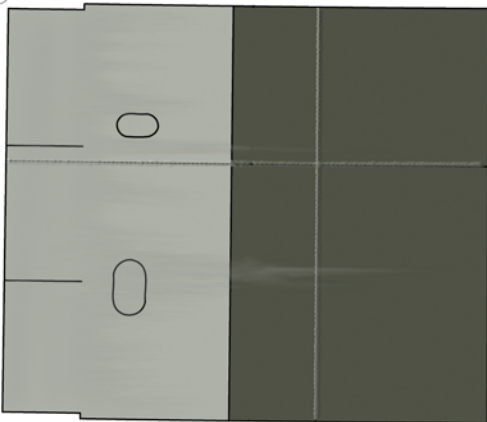

U-Boat Type VIIC 1/72 Scale

R

190 grms

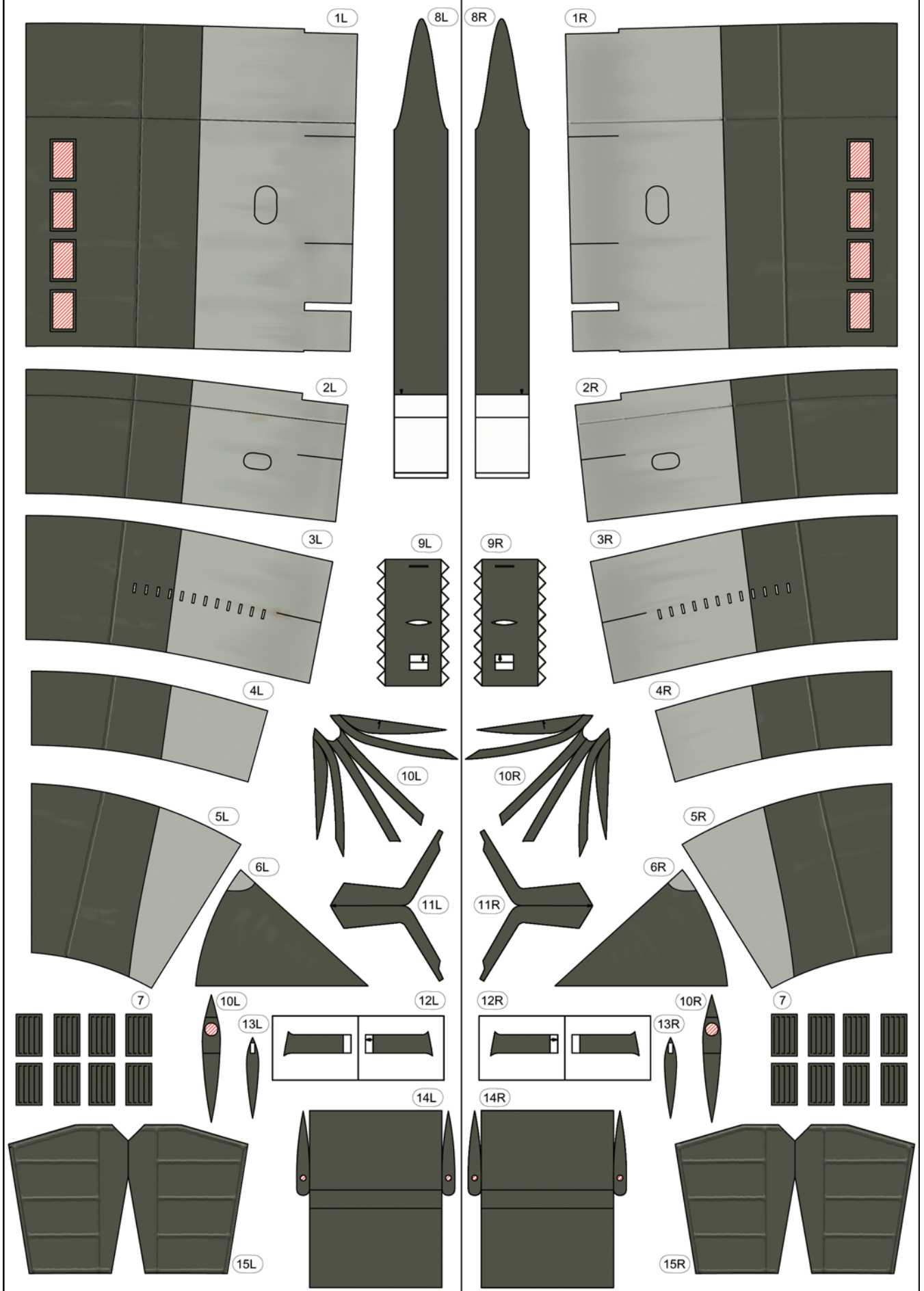

U-Boat Type VIIC 1/72 Scale

W

70 grms

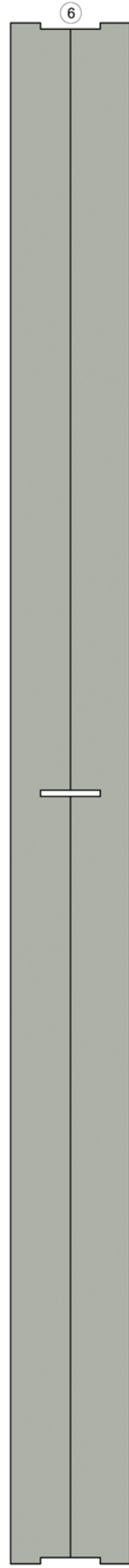
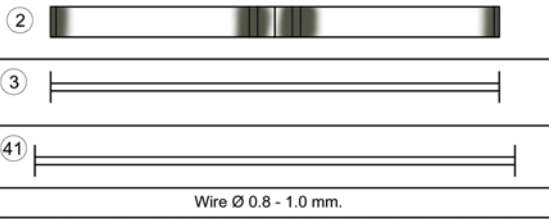
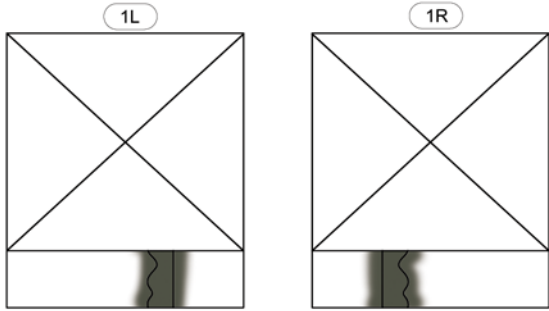

U-Boat Type VII C
U-Boat Type VII C

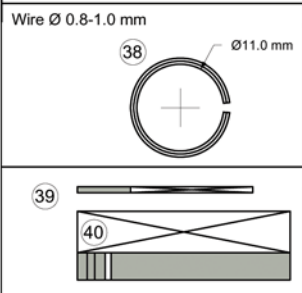
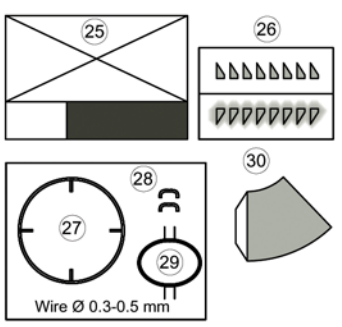
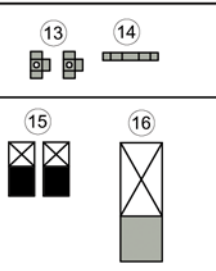
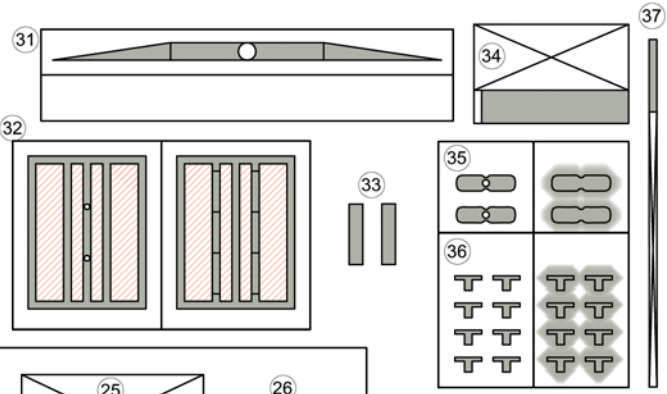
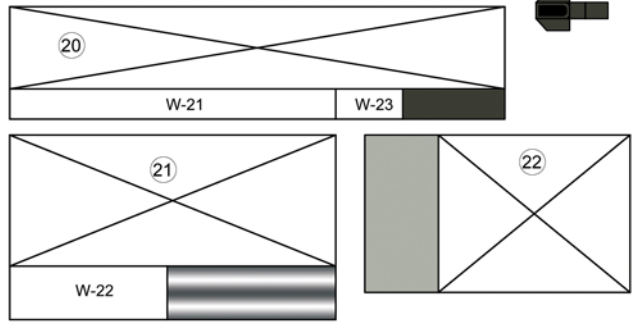
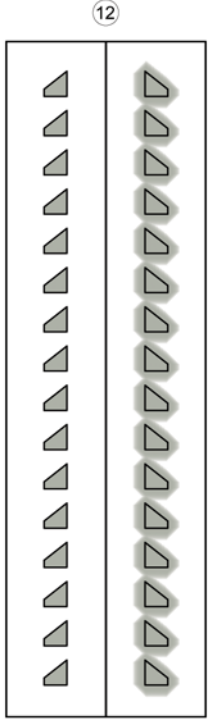
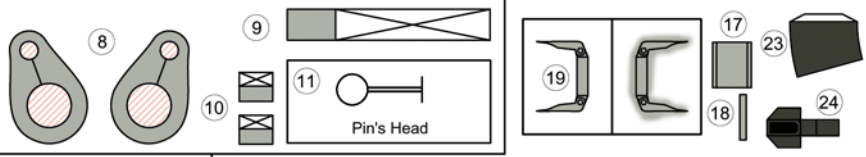

Wire Ø 0.8-1.0 mm

Ø11.0 mm

Wire Ø 0.3-0.5 mm

U-Boat Type VIIC 1/72 Scale

W

70 grms

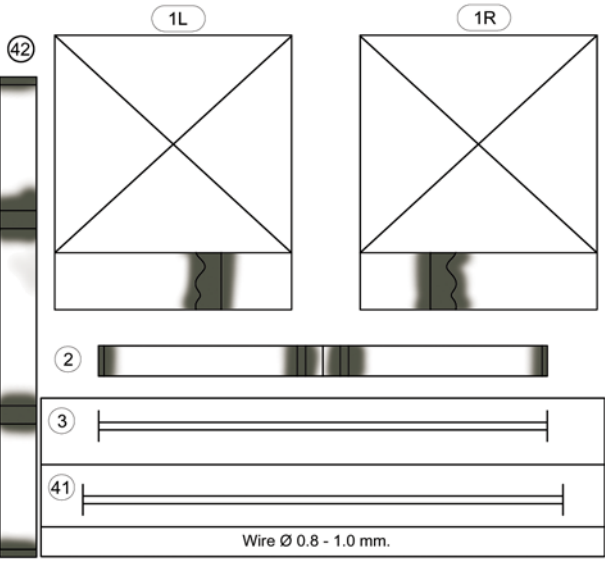

Part No. 4, 5, 6 and 7 need to be laminated to 1mm card board.



U-Boat Type VII C
U-Boat Type VII C

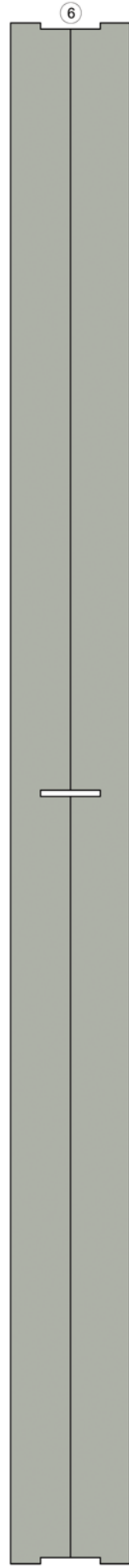
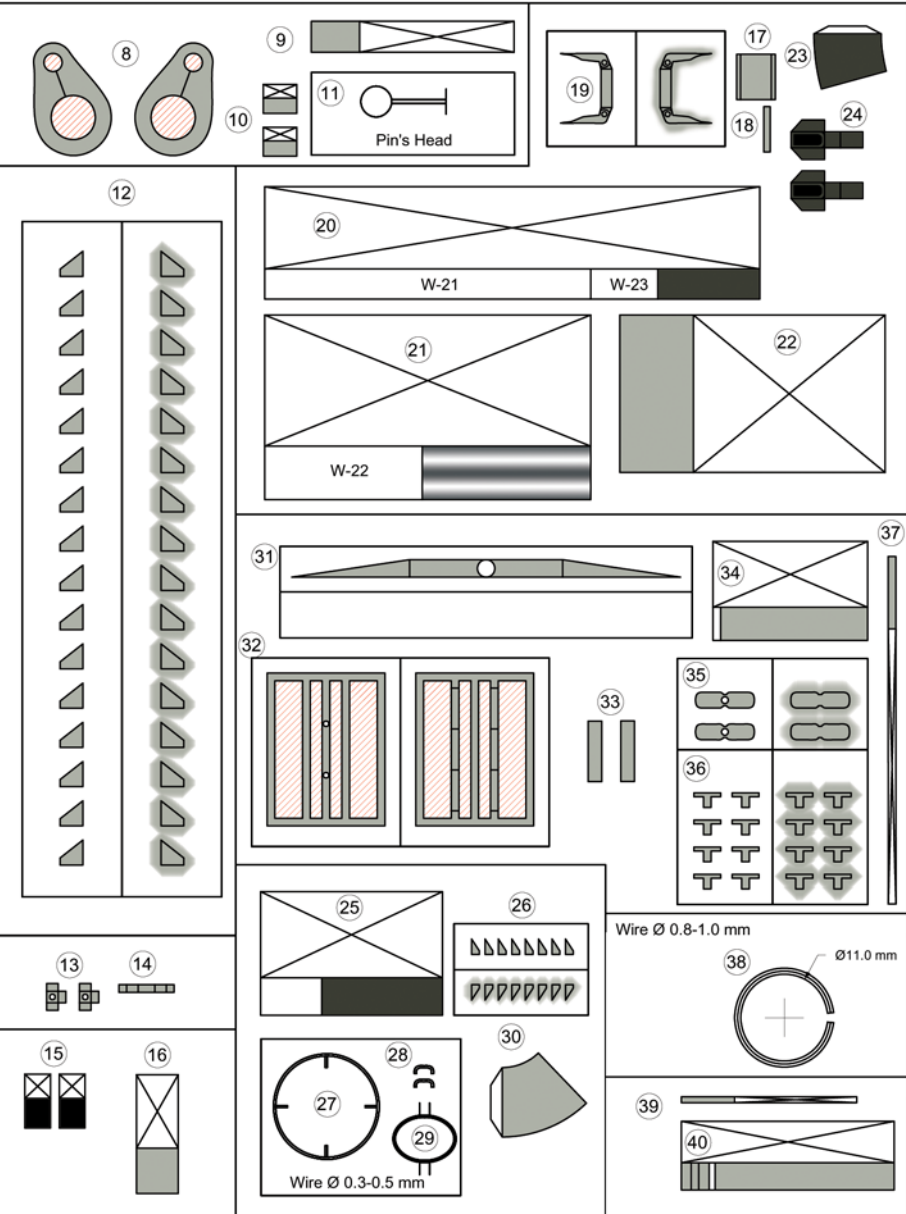

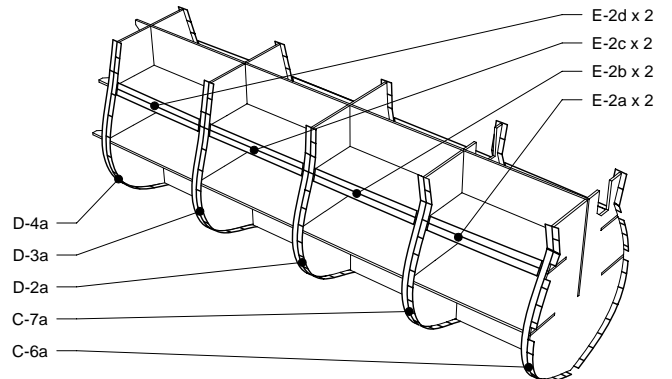
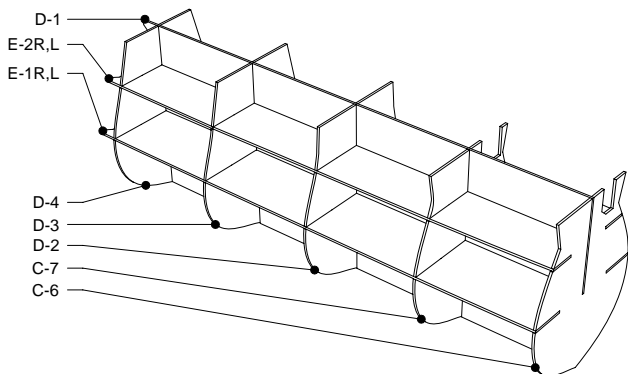
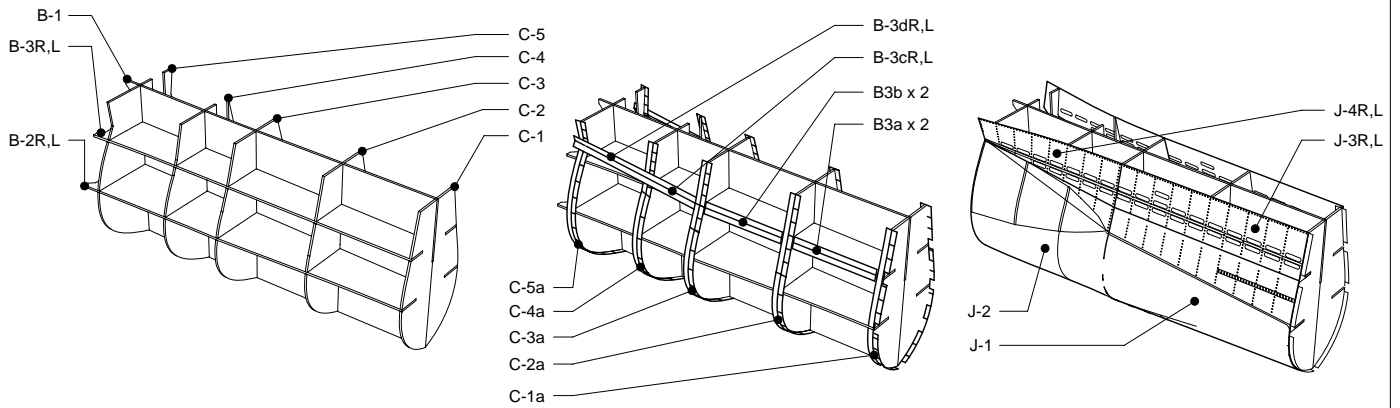
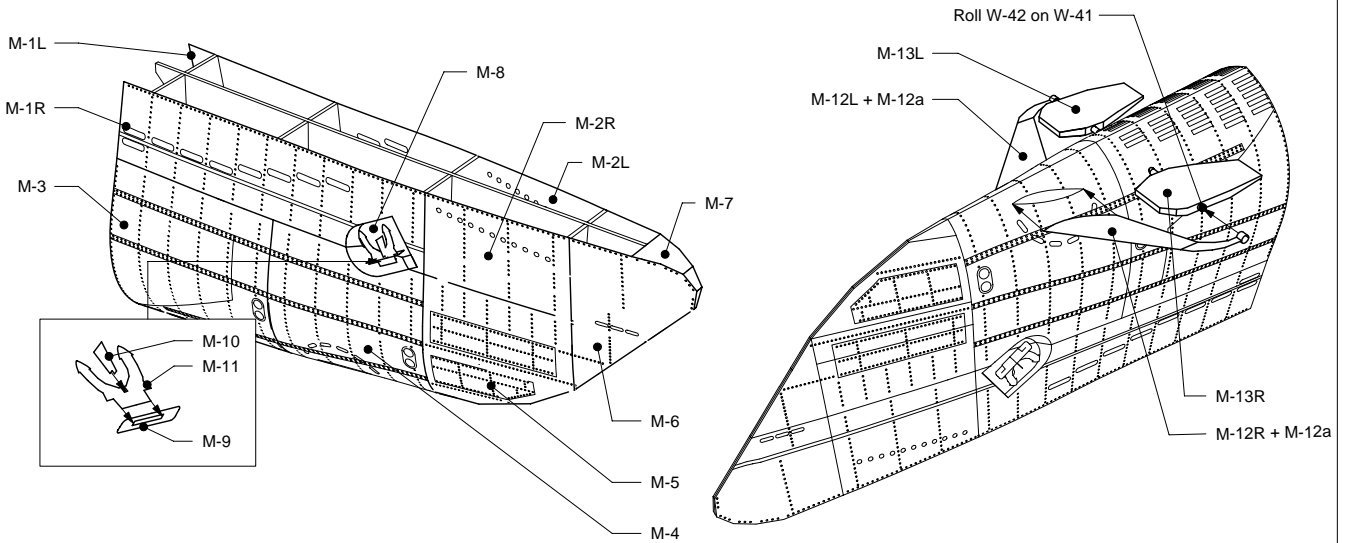
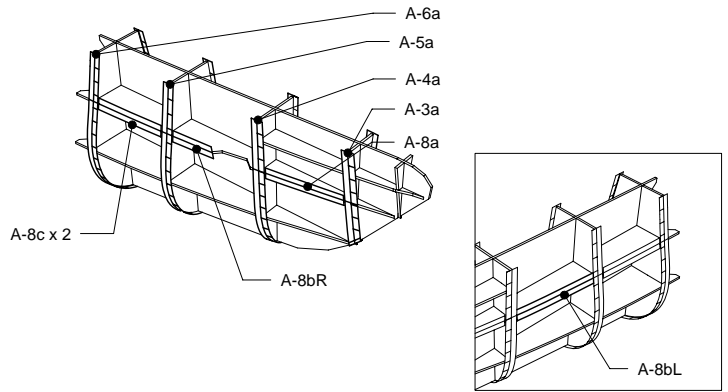
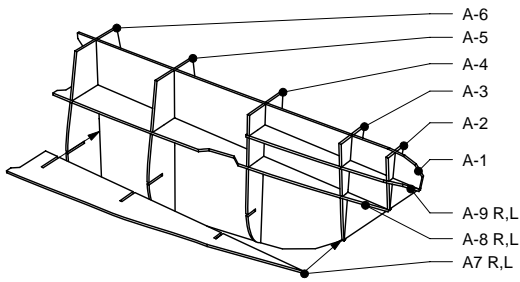

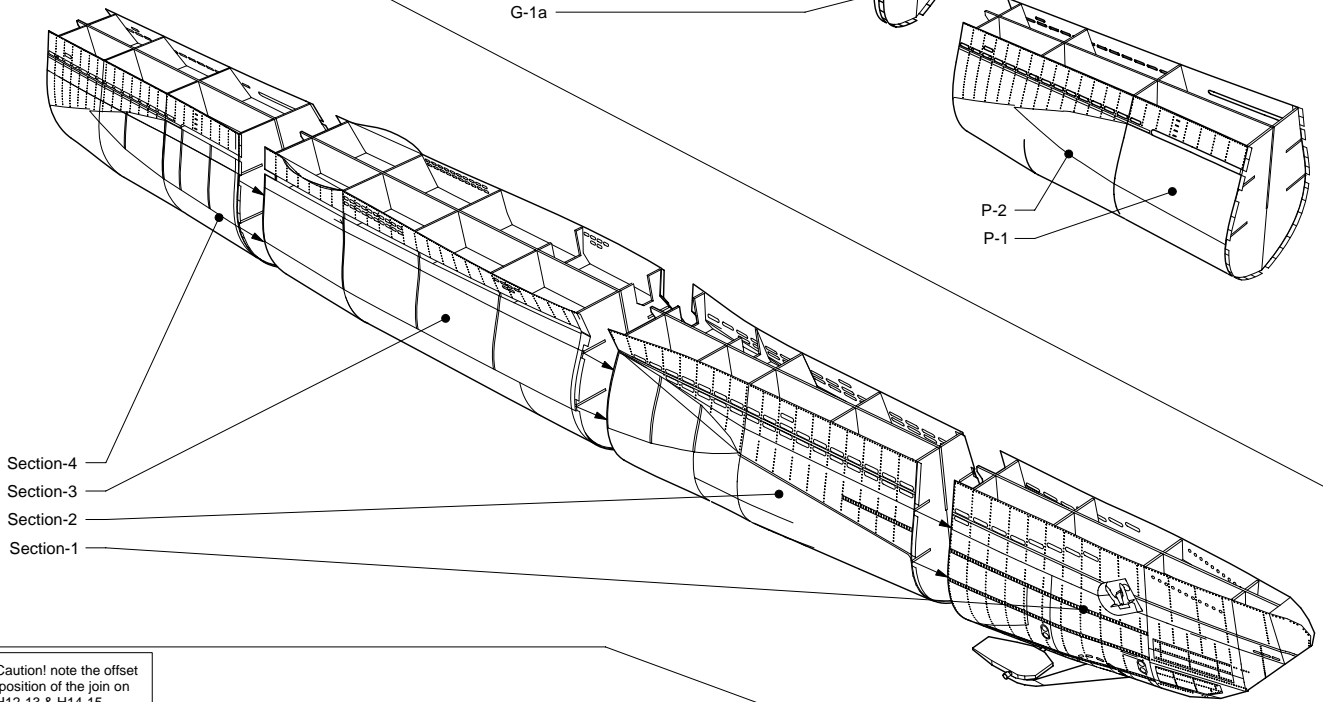
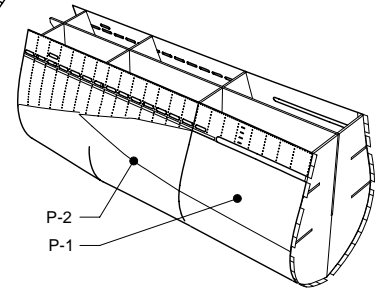
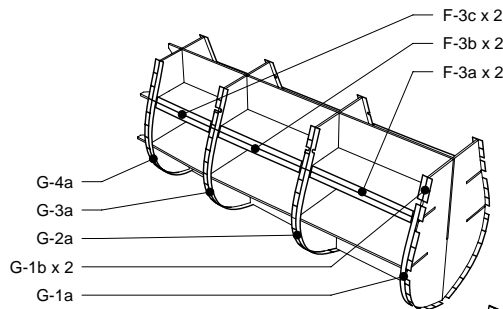
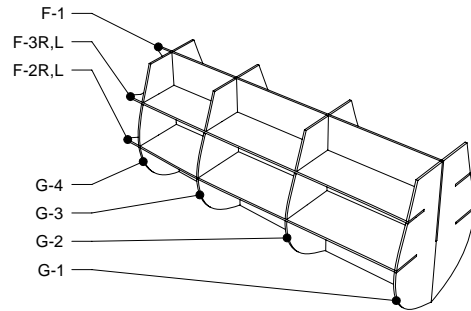
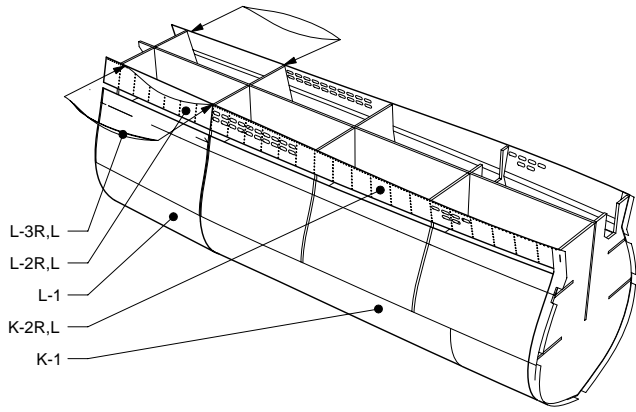

Caution! note the offset position of the join on H12-13 & H14-15

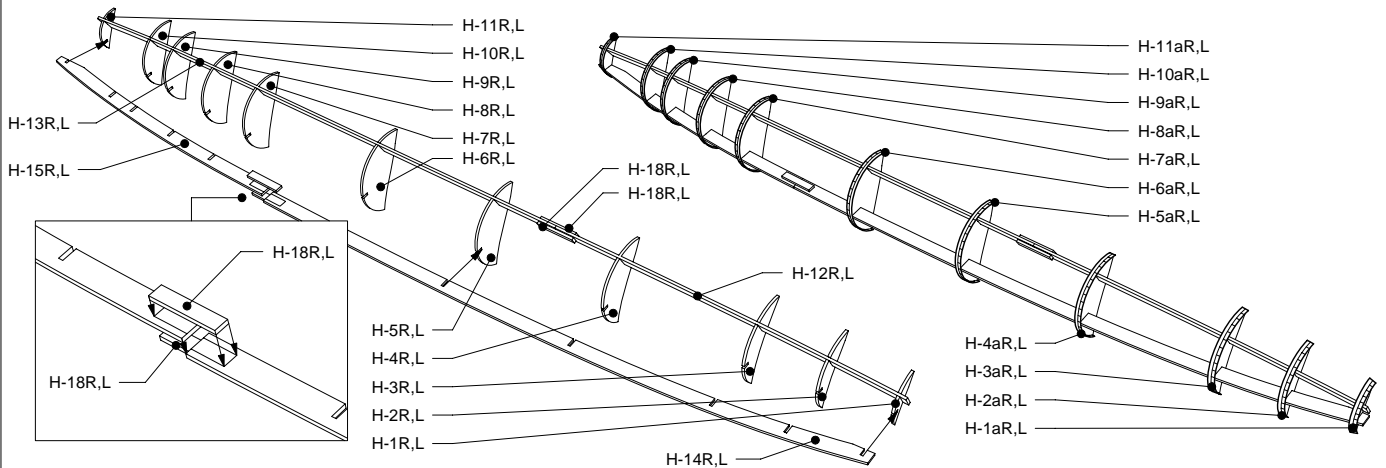

U-Boat Type VIIC 1/72 Scale

G

70 grms + 1mm Cardboard

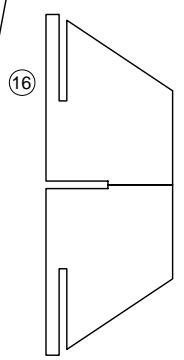
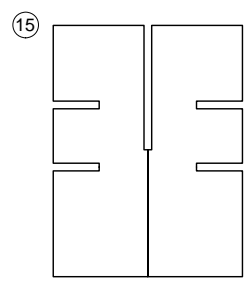
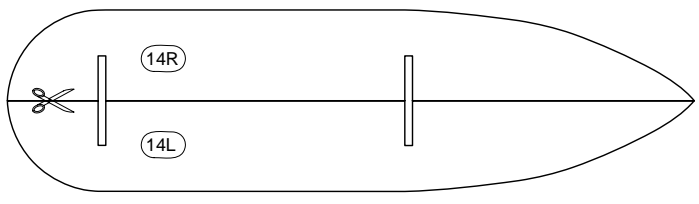
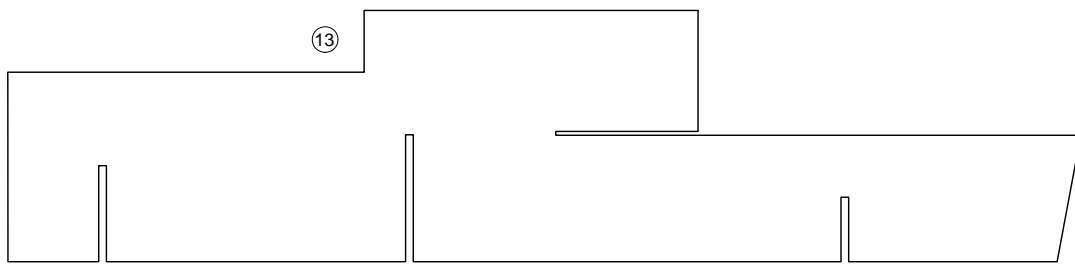
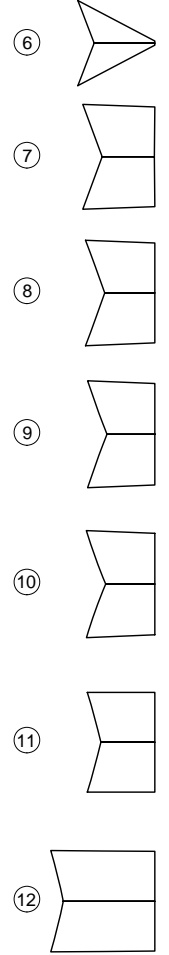
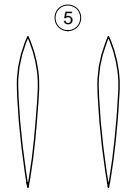
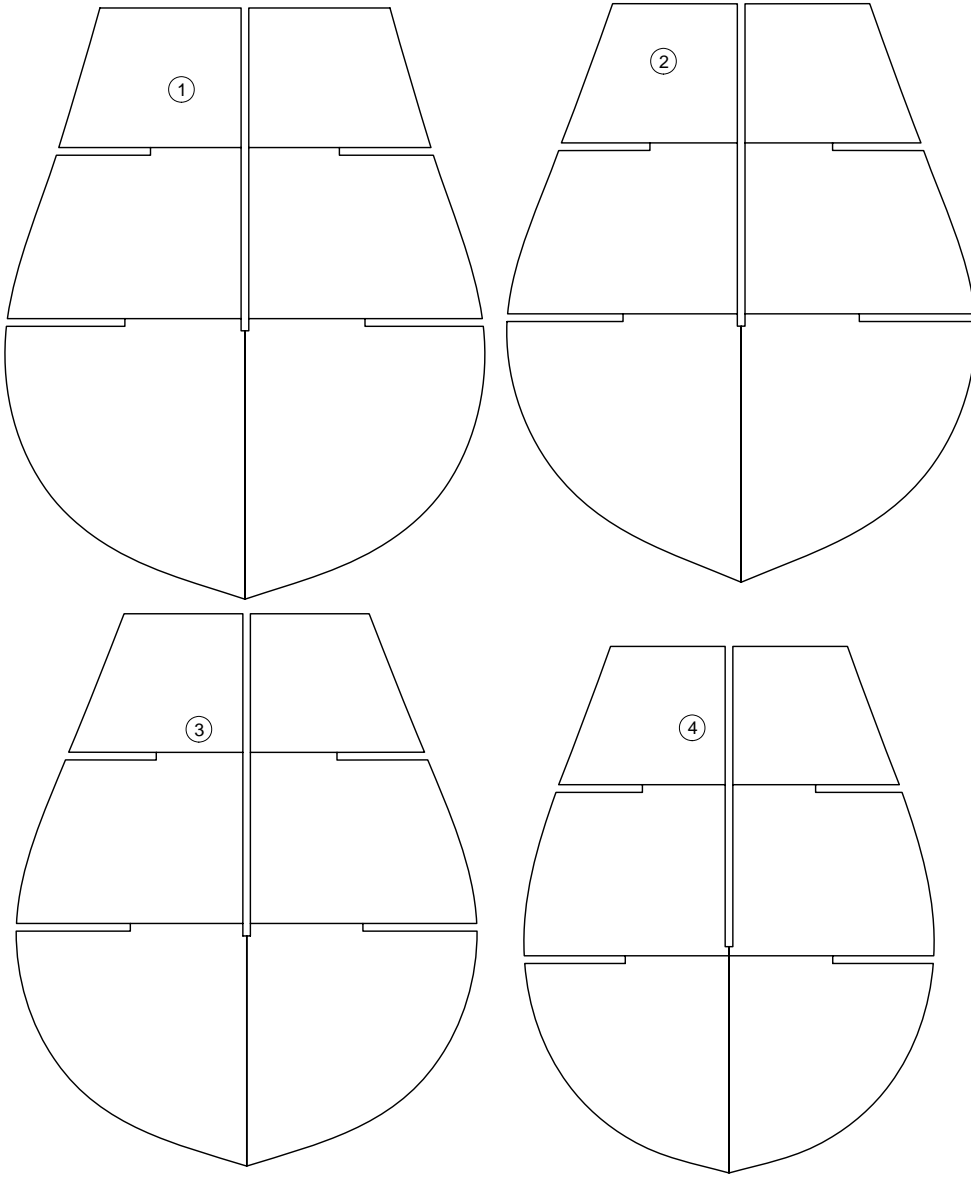

U-Boat Type VIIC 1/72 Scale

M

190 grms

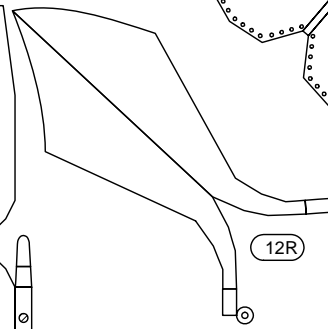
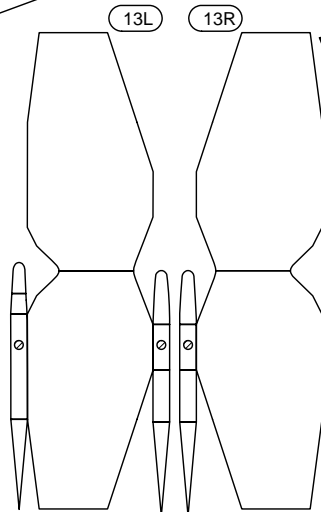
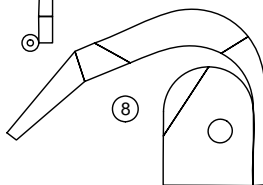
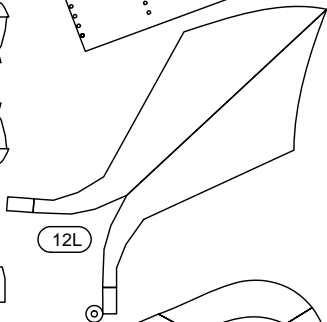
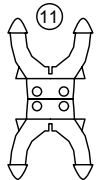
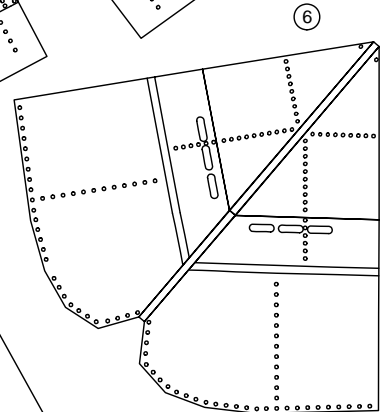
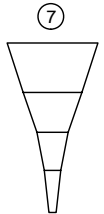
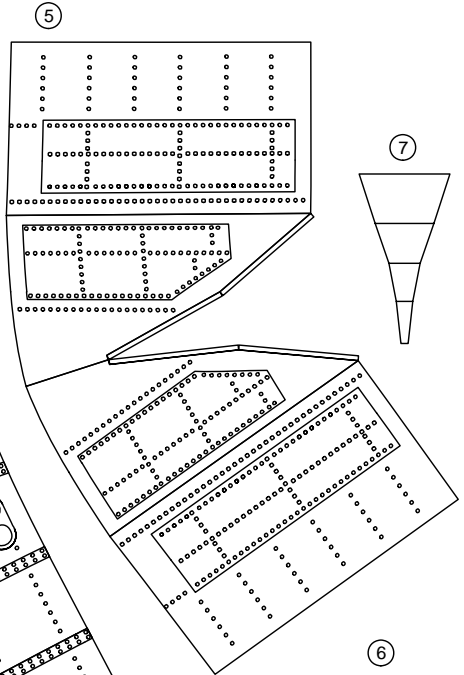
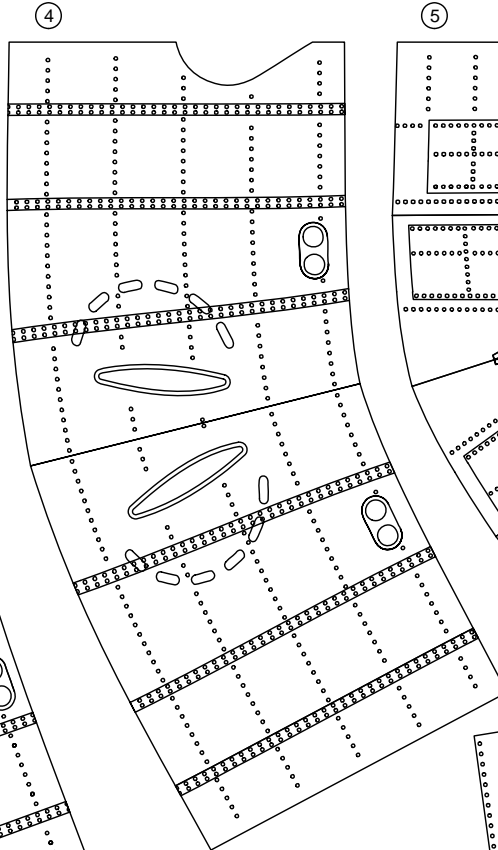
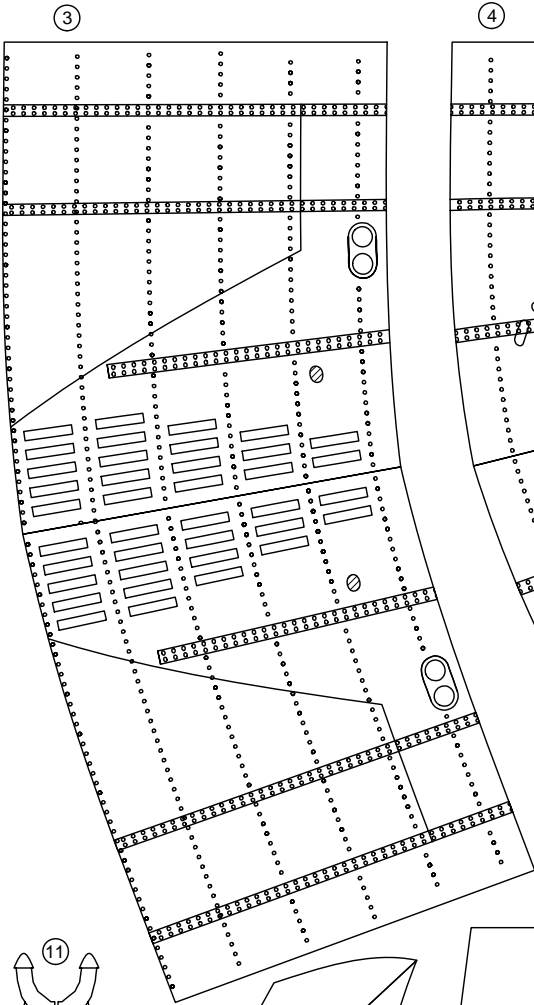
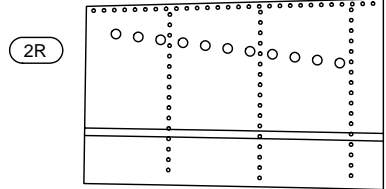
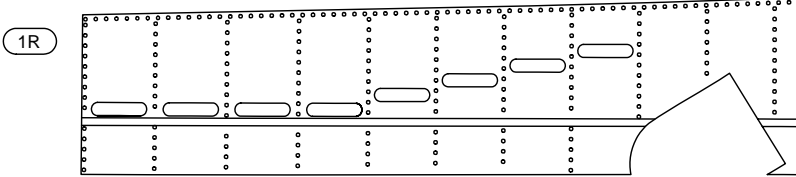
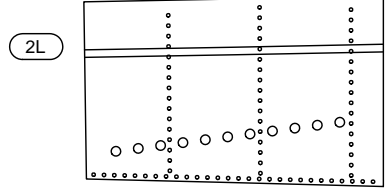
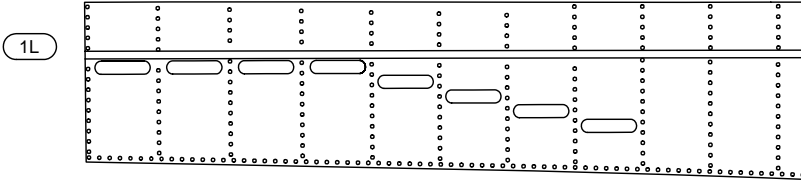

U-Boat Type VIIC 1/72 Scale

0

190 grms

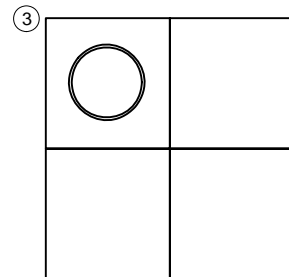
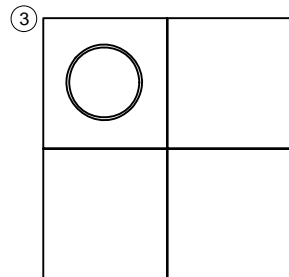
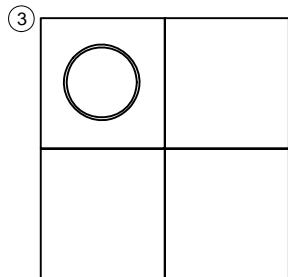
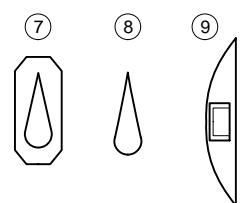
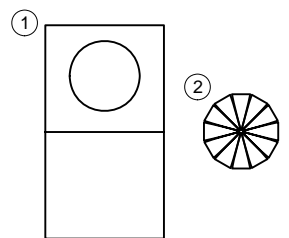
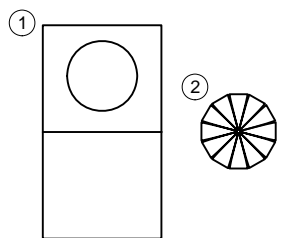
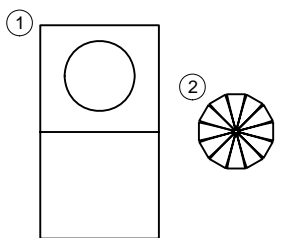
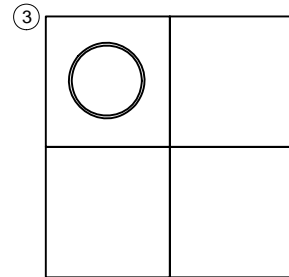
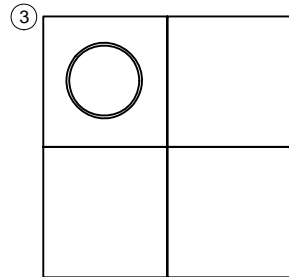
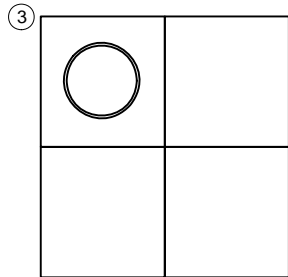
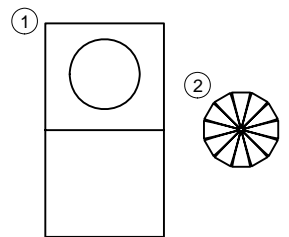
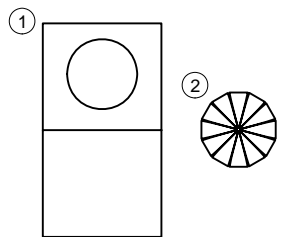
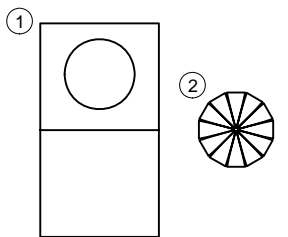
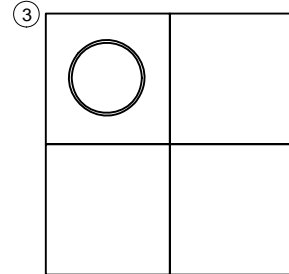
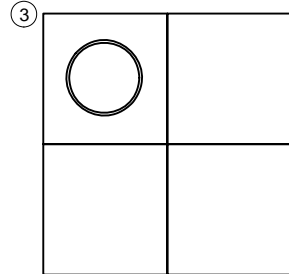
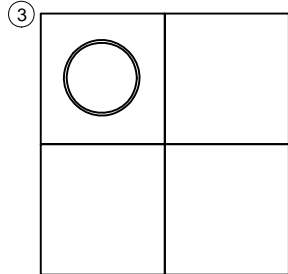
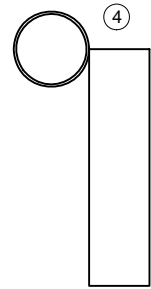
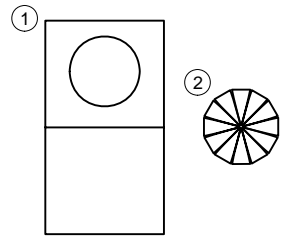
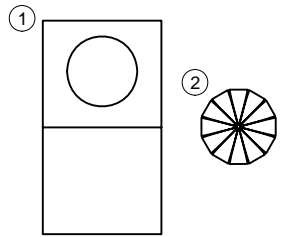
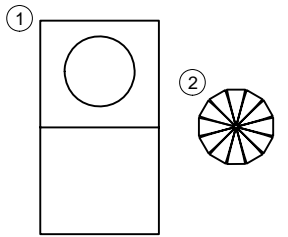

U-Boat Type VIIC 1/72 Scale

W 70 grms

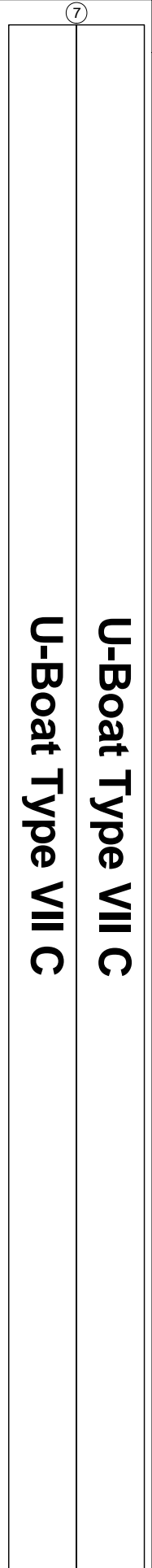
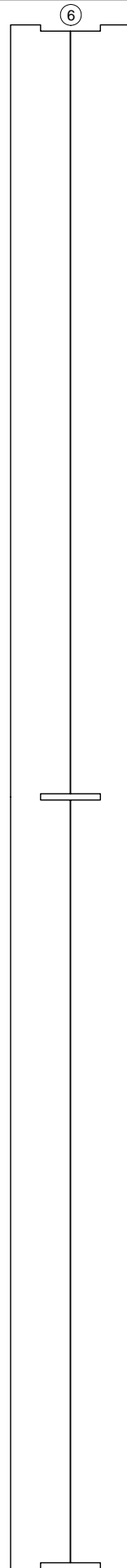
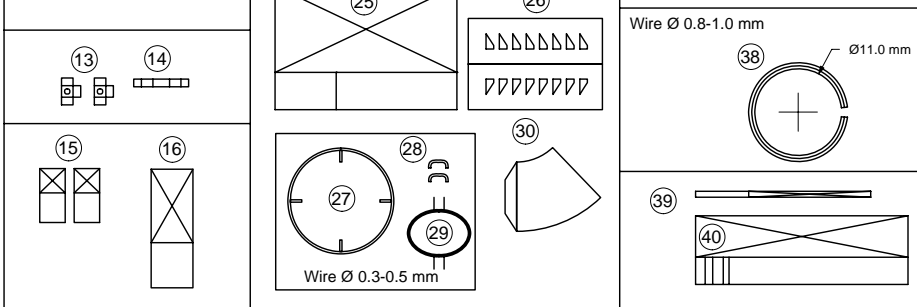
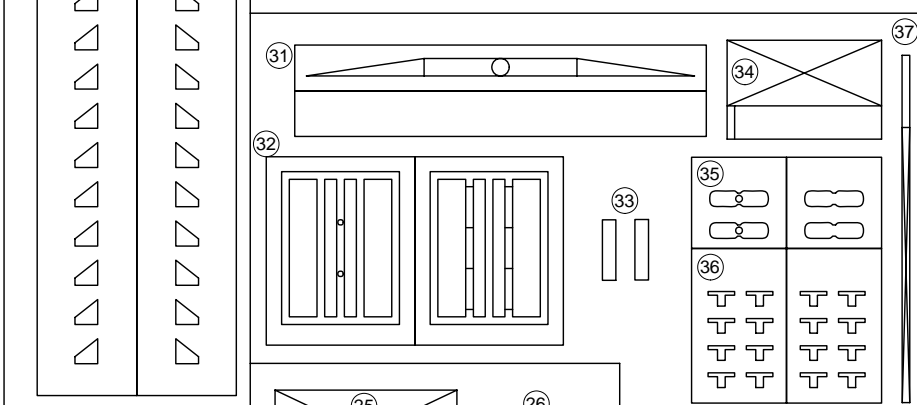
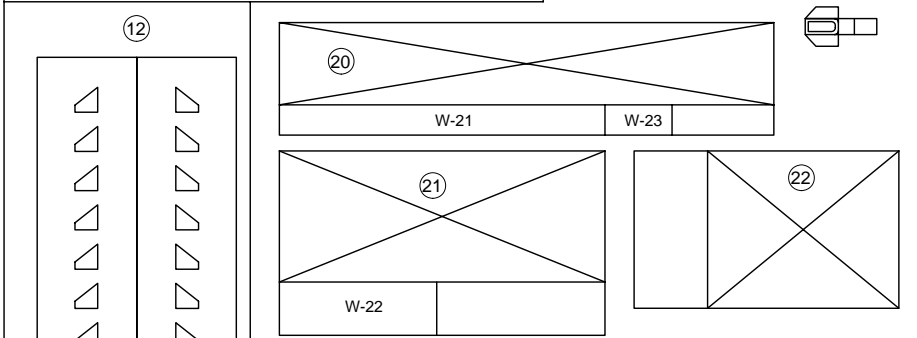
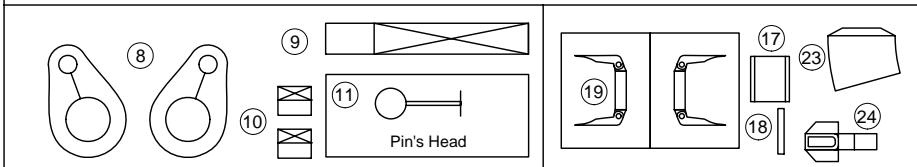
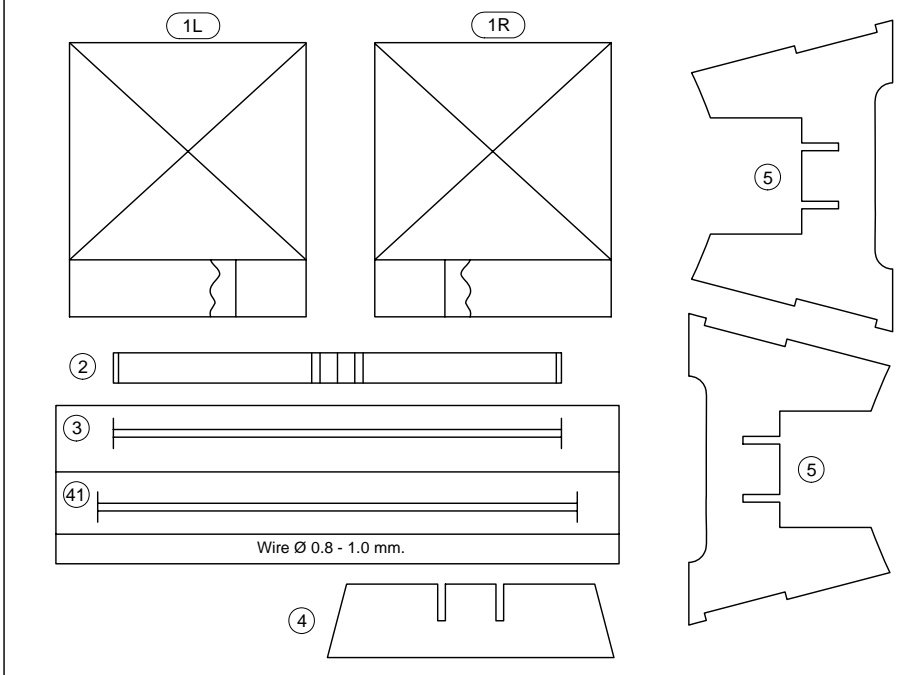

U-Boat Type VIIC
U-Boat Type VIIC

U-Boat Type VIIC 1/72 Scale

W 70 grms

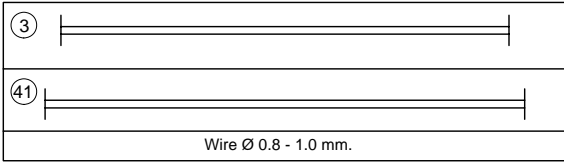
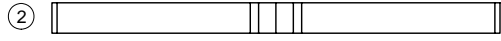
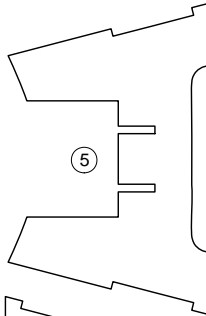
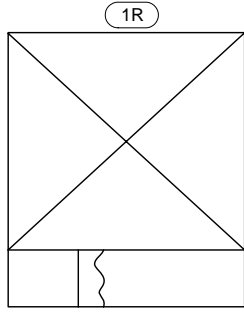
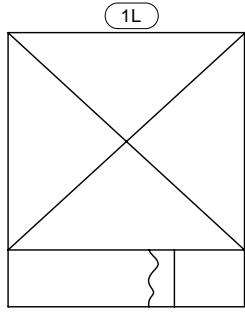

Wire Ø 0.8 - 1.0 mm.

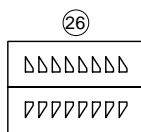
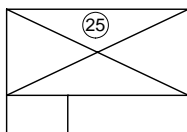
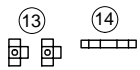
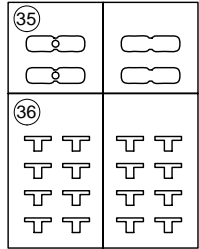
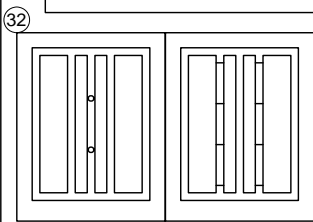
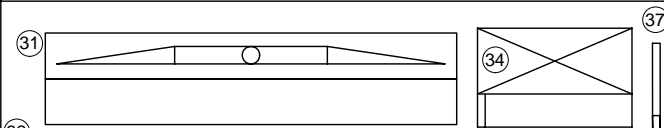
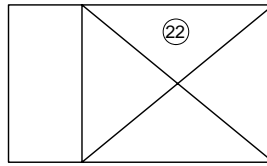
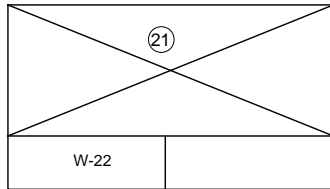
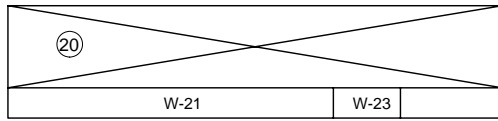
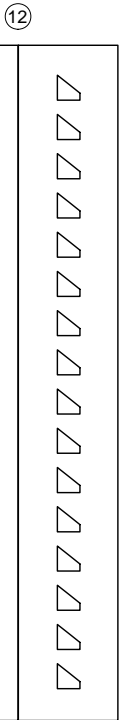
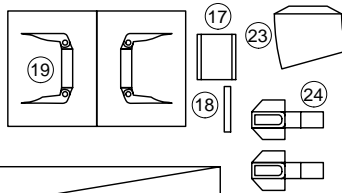
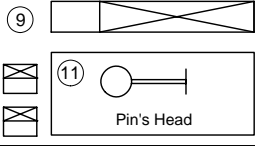
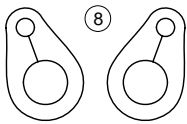
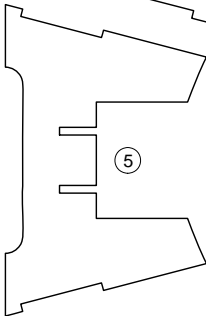

Wire Ø 0.8-1.0 mm

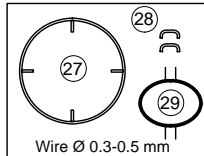
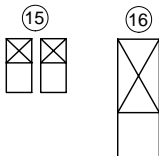
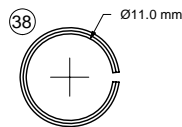

Wire Ø 0.3-0.5 mm

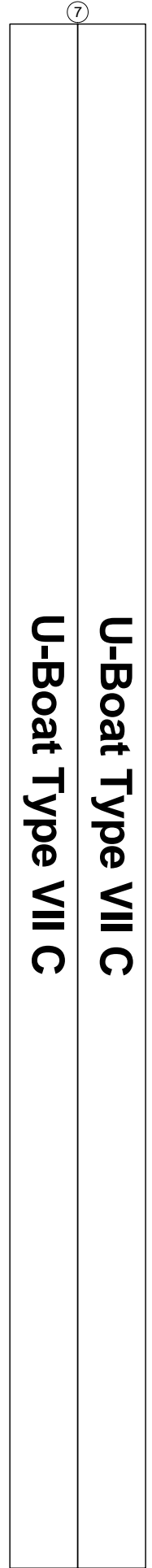
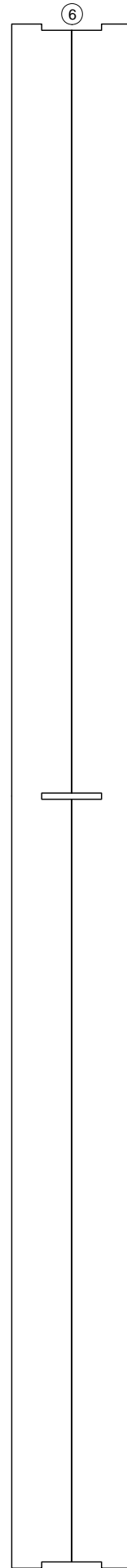
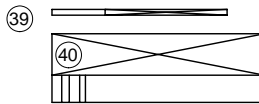
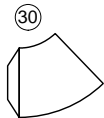

U-Boat Type VII C U-Boat Type VII C

U-Boat Type VIIC 1/72 Scale

W 70 grms

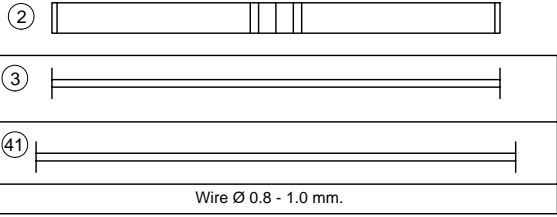
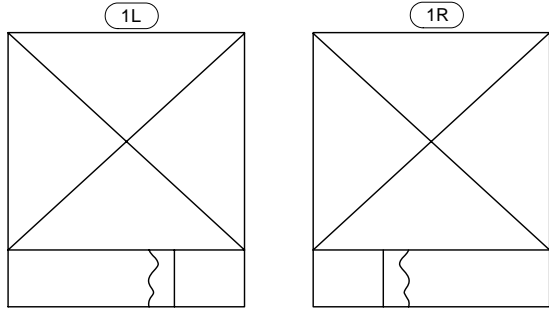

Wire Ø 0.8 - 1.0 mm.

Part No. 4,5,6 and 7 need to be laminated to 1mm card board.

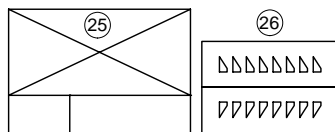
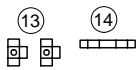
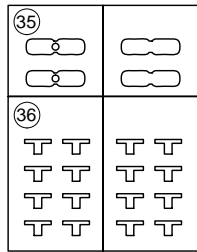
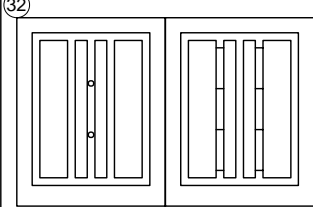
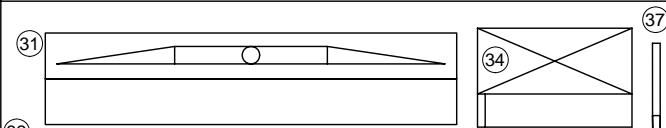
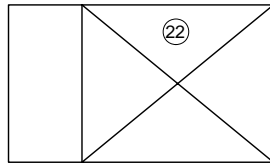
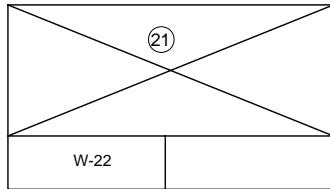
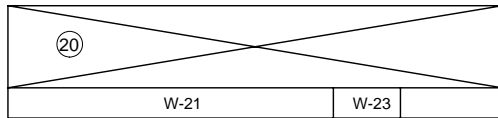
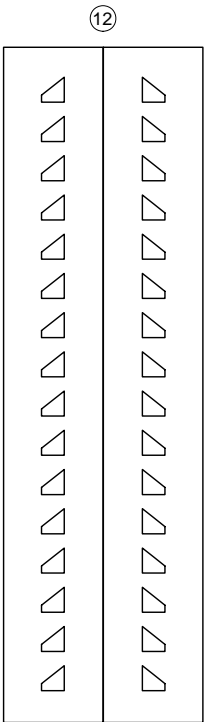
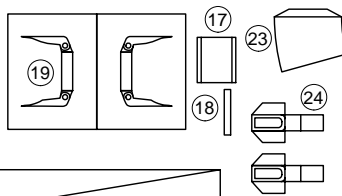
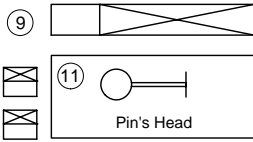
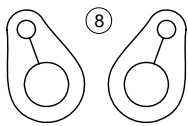
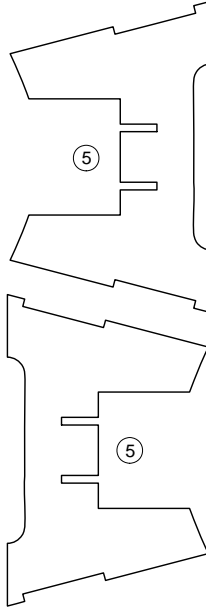

Wire Ø 0.8-1.0 mm

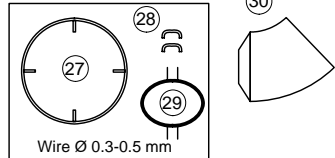
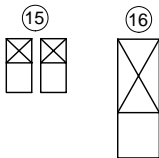
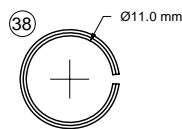

Wire Ø 0.3-0.5 mm

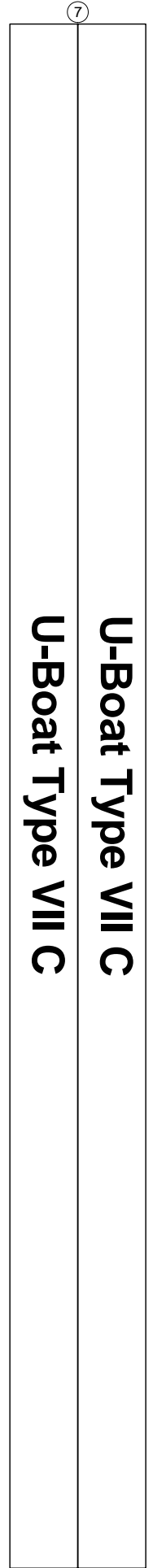
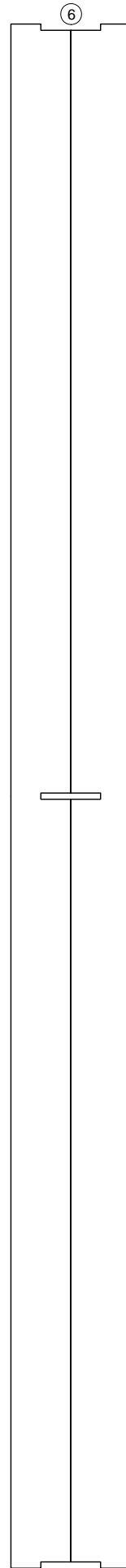
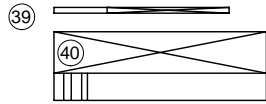

U-Boat Type VII C

U-Boat Type VII C

U-Boat Type VIIC 1/72 Scale

W 70 grms

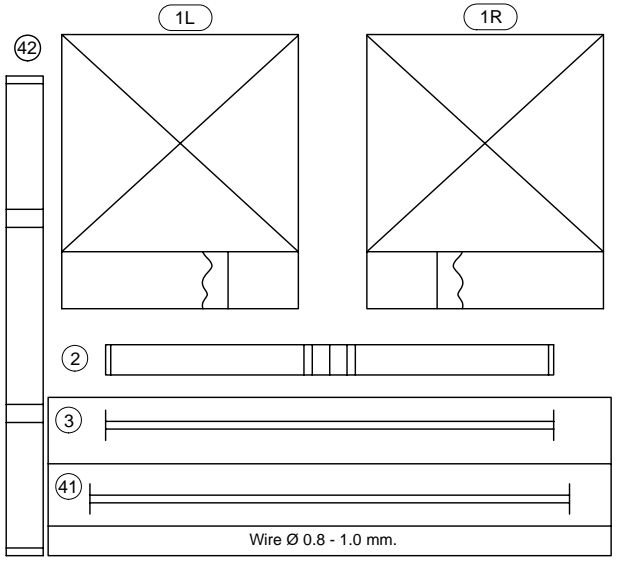

Part No. 4,5,6 and 7 need to be laminated to 1mm card board.

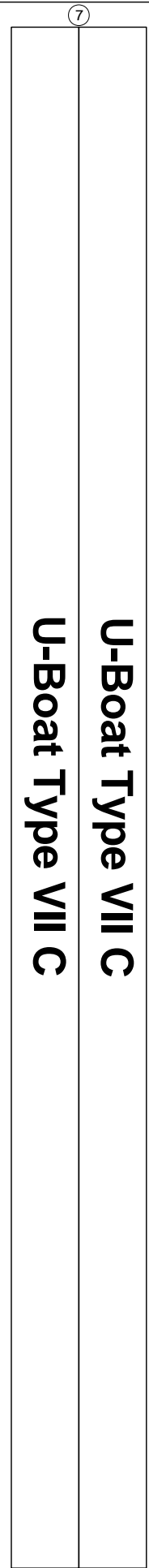
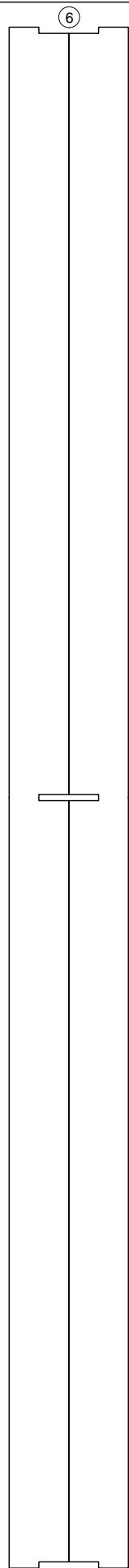
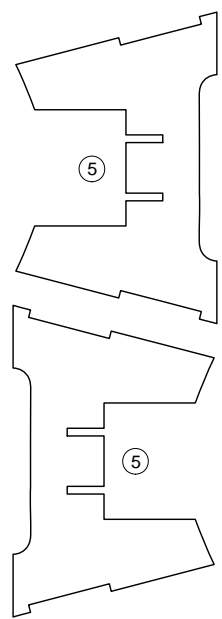
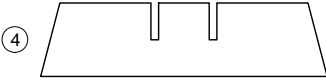

U-Boat Type VII C

U-Boat Type VII C

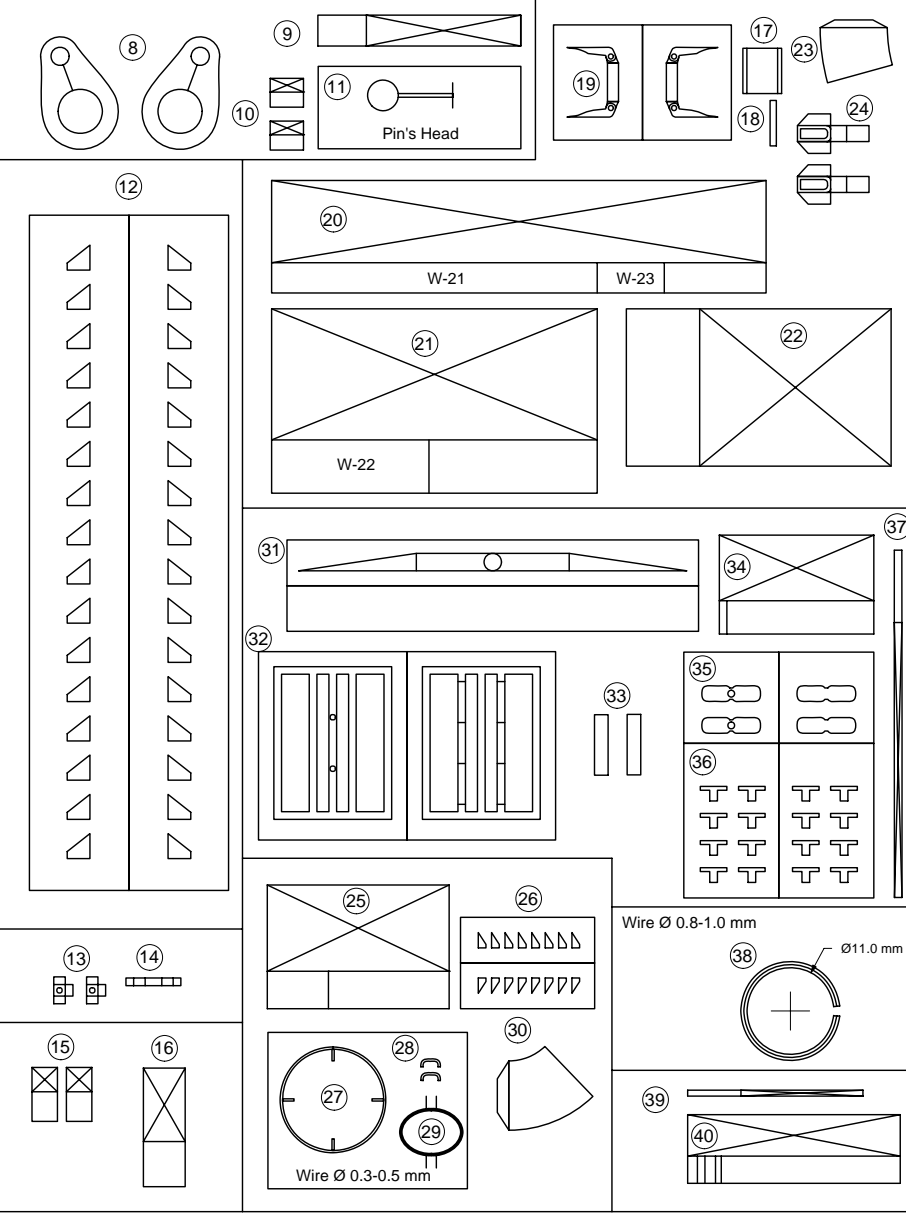

U-Boat Type VIIC 1/72 Scale

Q

190 grms

5L

4L

3L

2L

1L

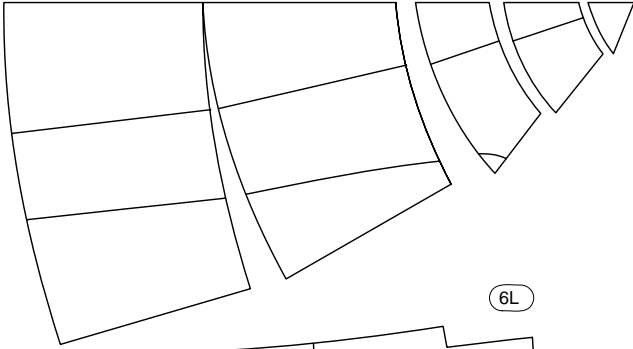

6L

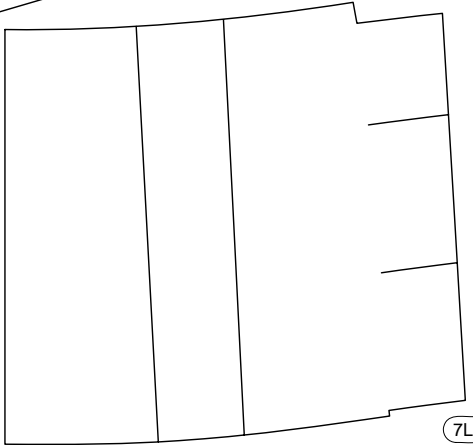

7L

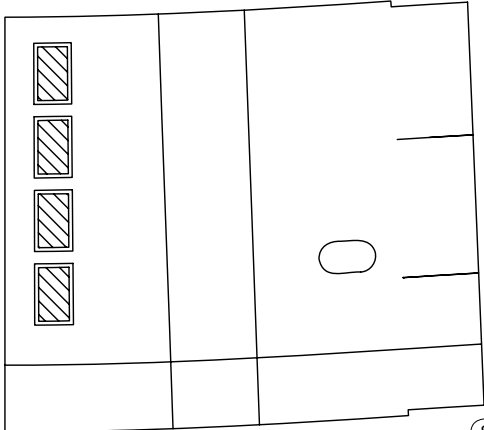

8L

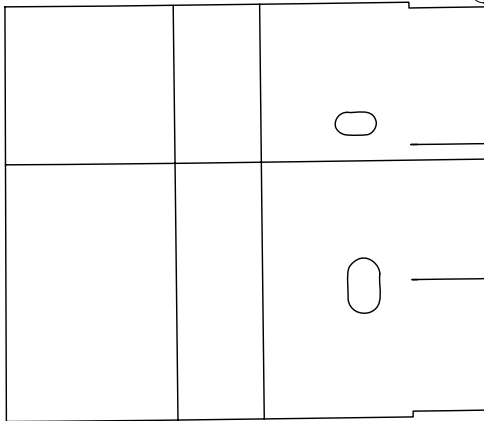

1R

2R

3R

4R

5R

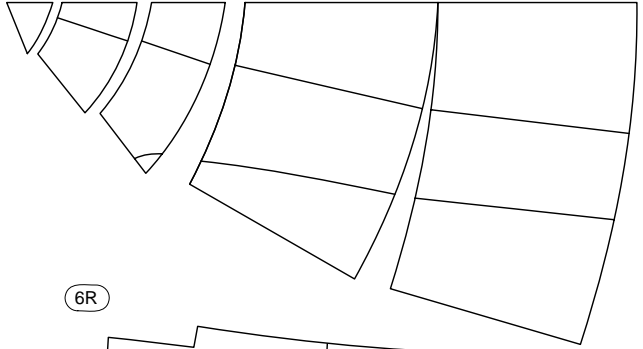

6R

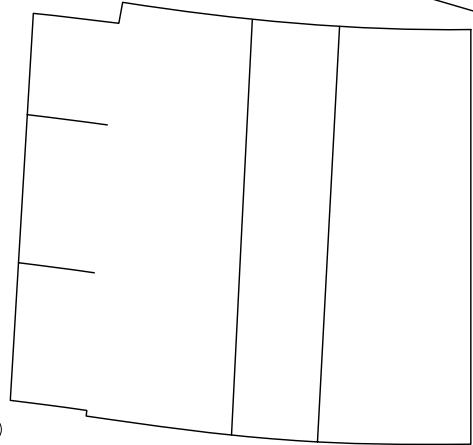

7R

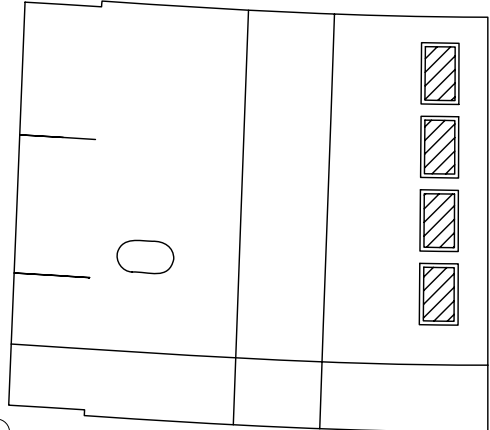

8R

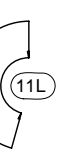
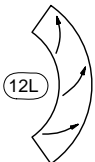
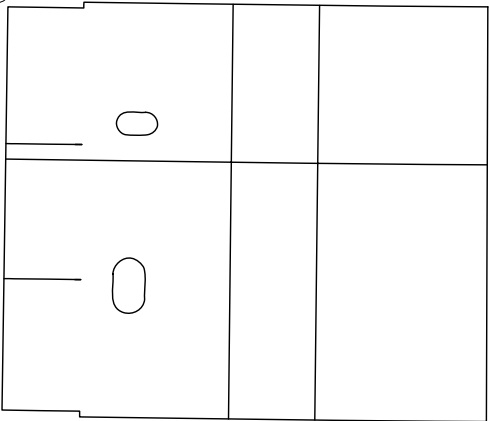

10L

9L

8L



8R



9R



10R



12R



U-Boat Type VIIC 1/72 Scale

R

190 grms

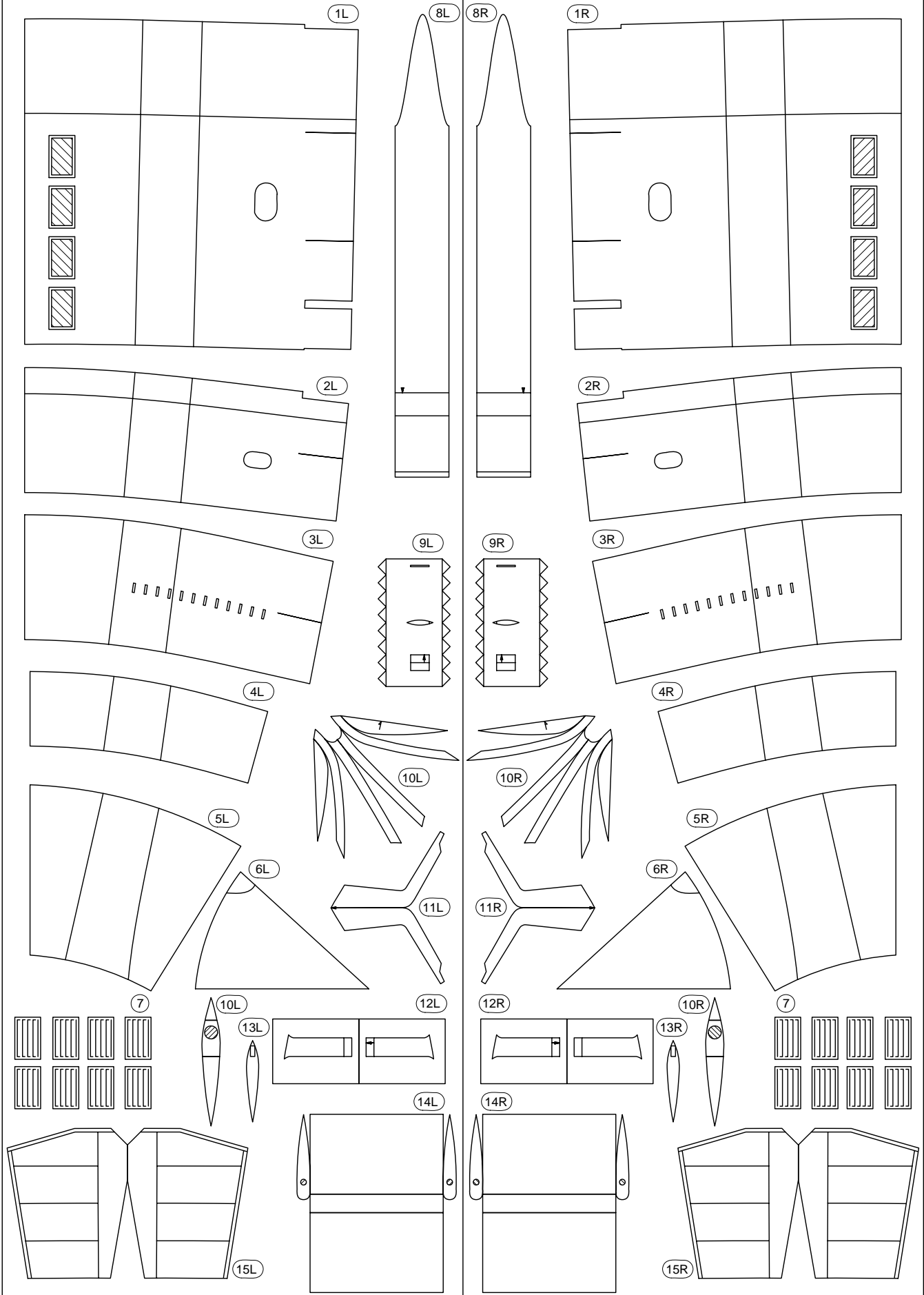

U-Boat Type VIIC 1/72 Scale

M

190 grms

1L



2L



1R



2R



3



4

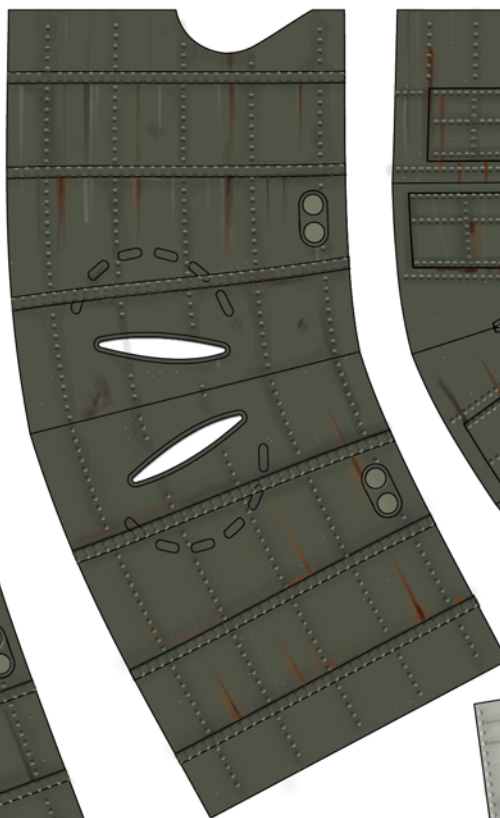

5

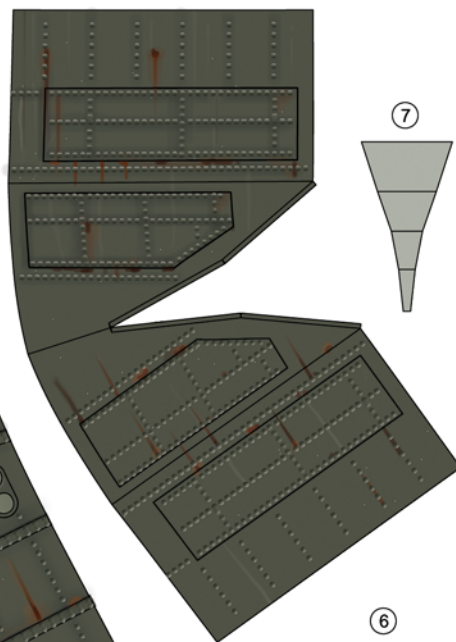

7

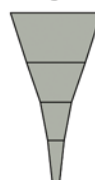

6

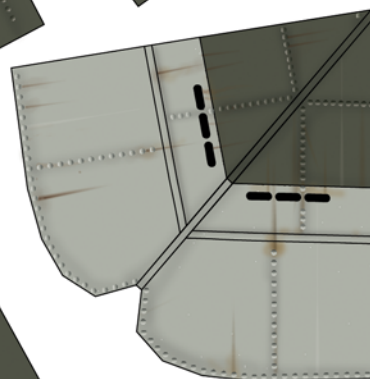

11

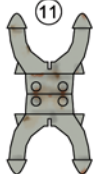

12L

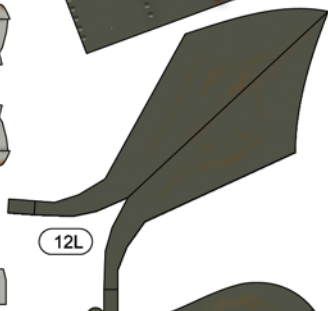

13L

13R

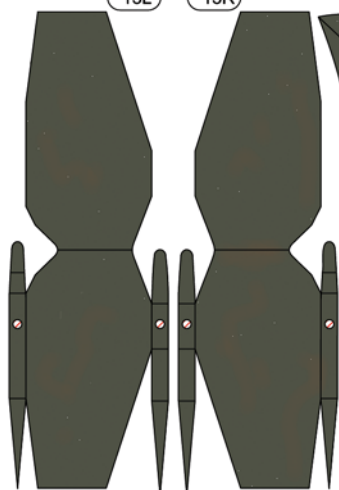

12R

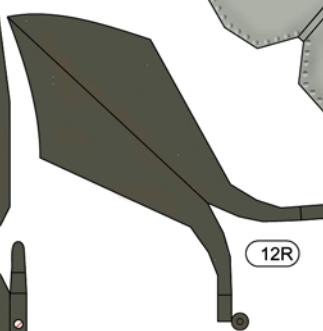

10



9



8

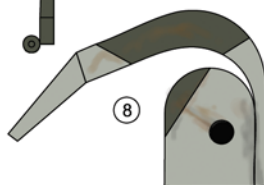

14



U-Boat Type VIIC 1/72 Scale

0

190 grms

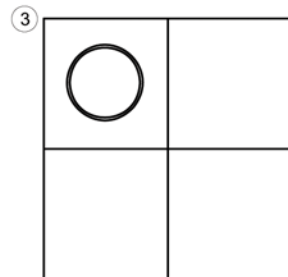
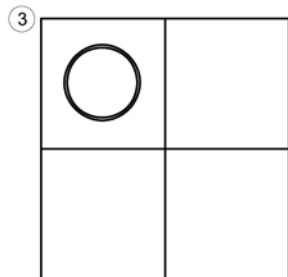
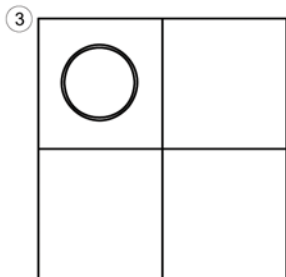
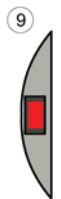
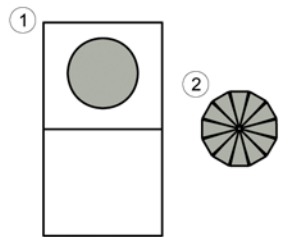
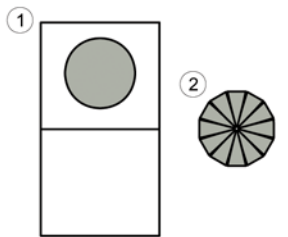
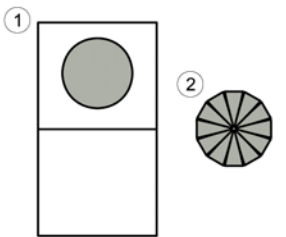
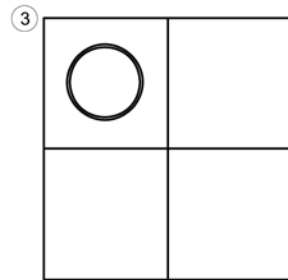
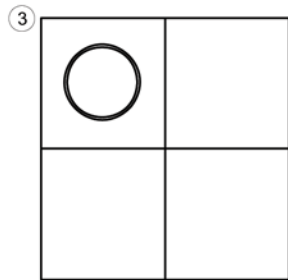
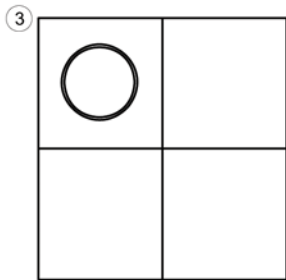
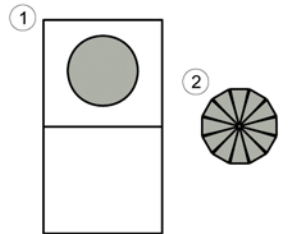
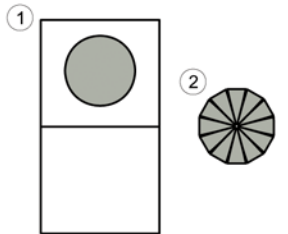
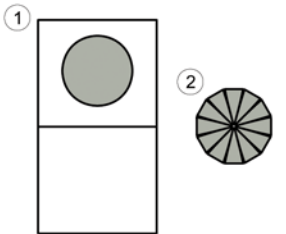
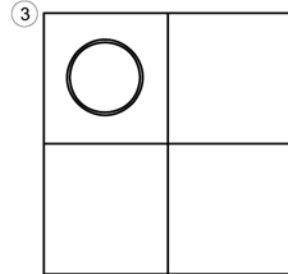
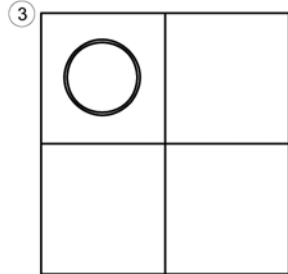
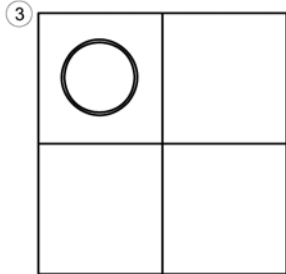
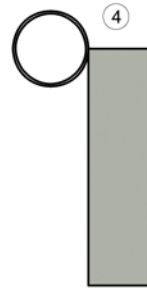
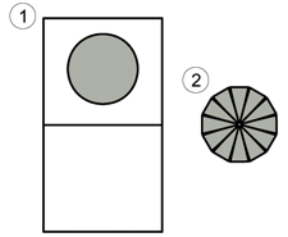
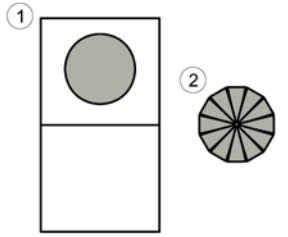
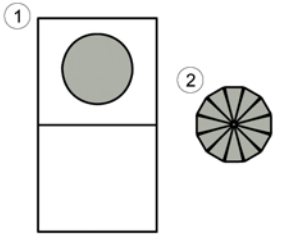

①

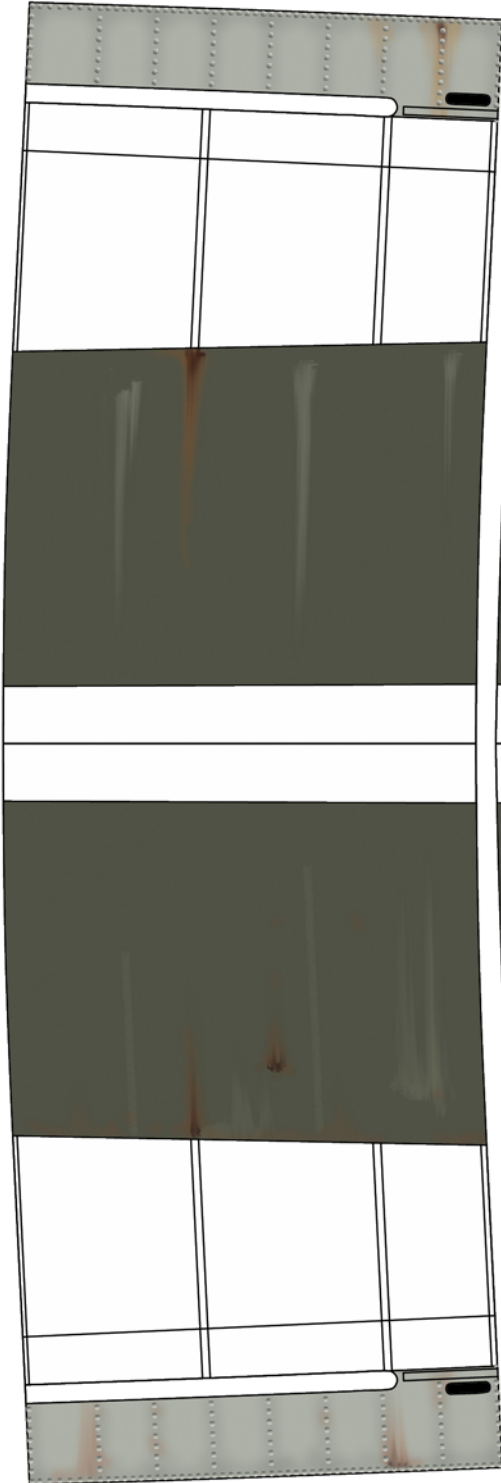

②

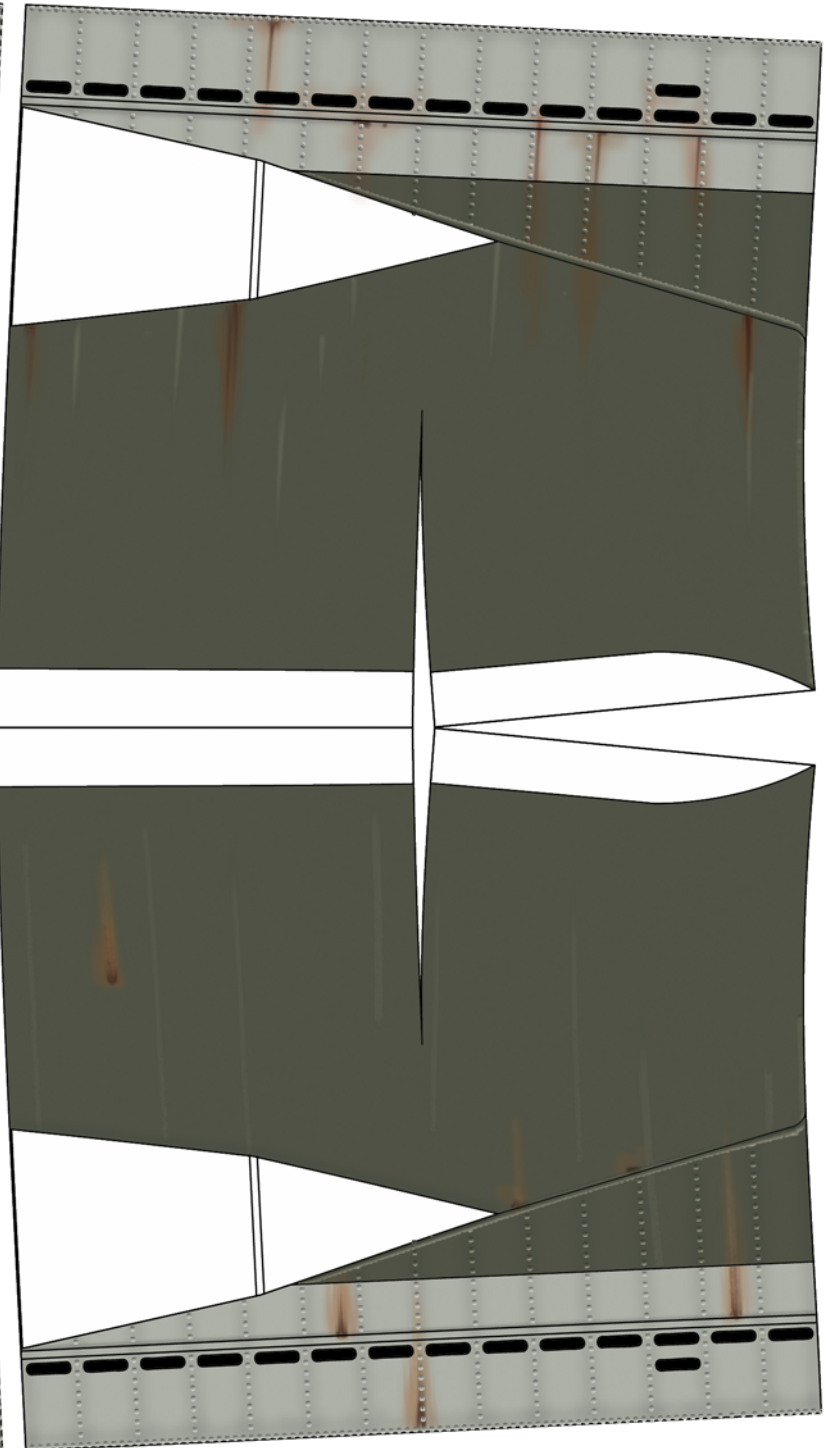

U-Boat Type VIIC 1/72 Scale

Q

190 grms

5L 4L 3L 2L 1L

1R 2R 3R 4R 5R

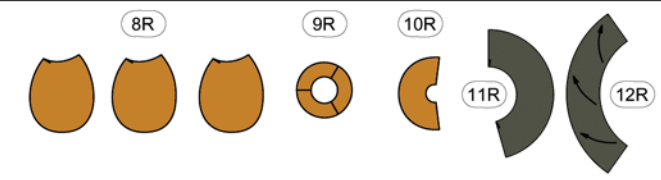
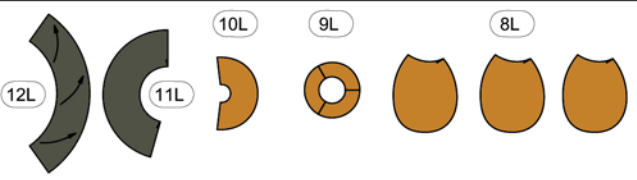
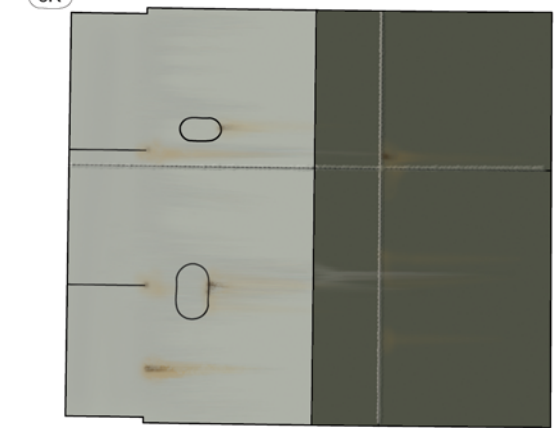
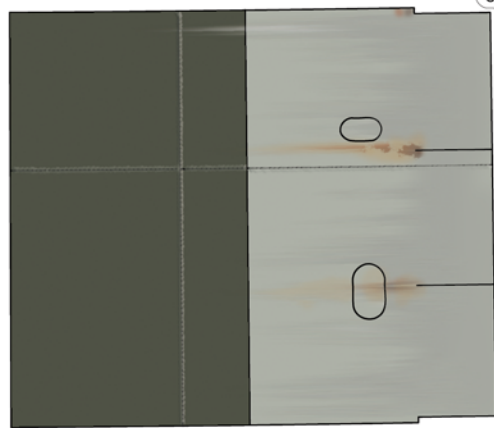
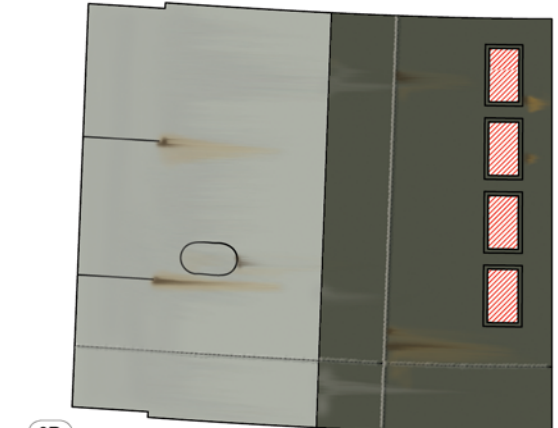
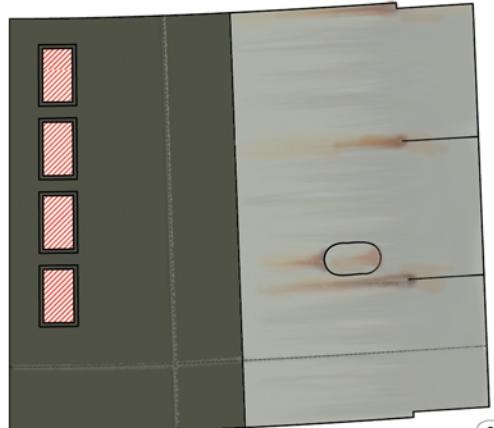
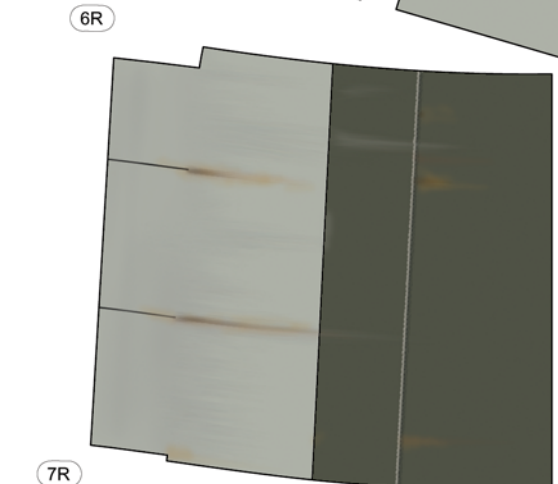
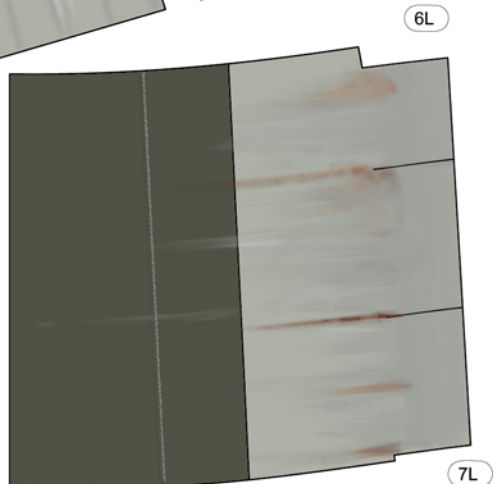
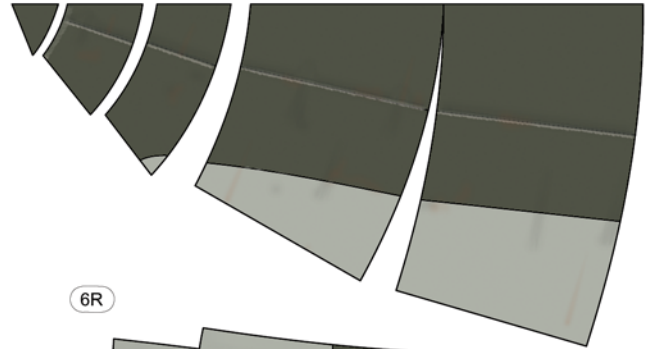
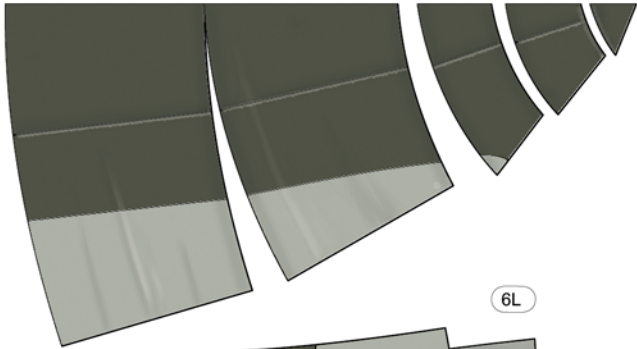

U-Boat Type VIIC 1/72 Scale

W

70 grms

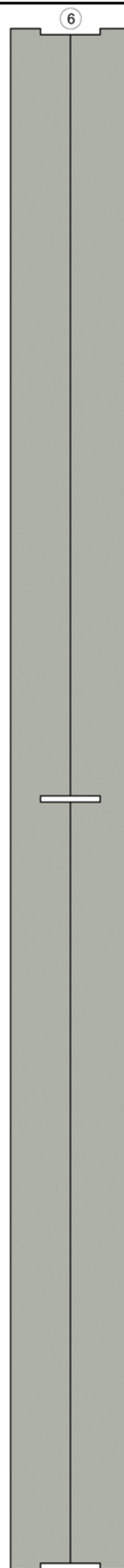
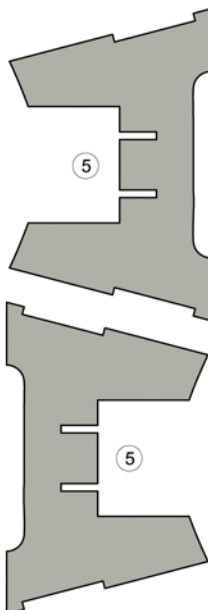
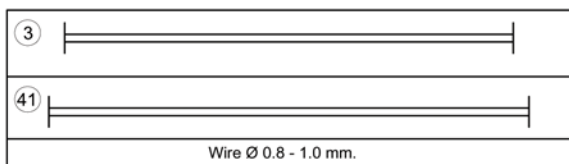
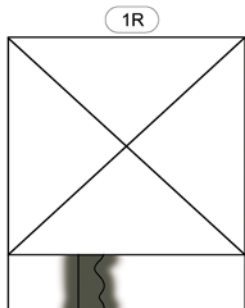
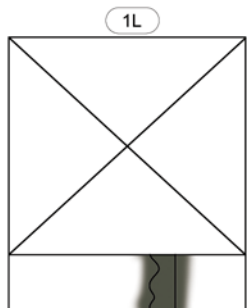

U-Boat Type VII C
U-Boat Type VII C

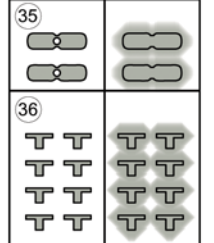
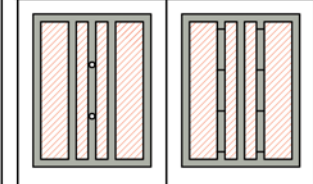
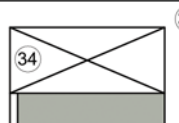
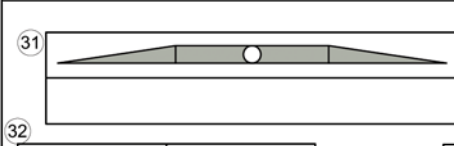
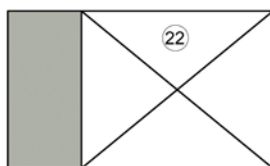
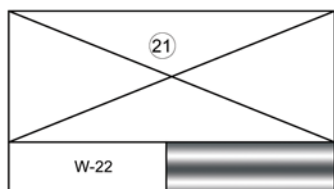
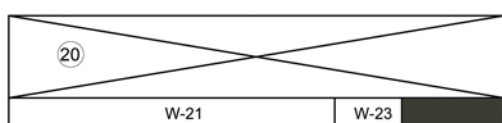
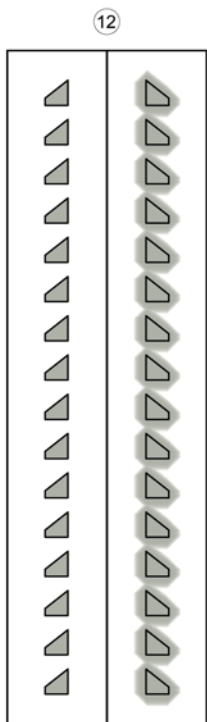
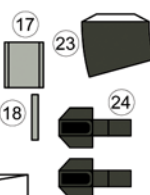
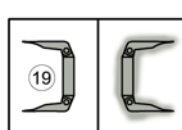
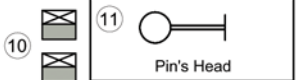
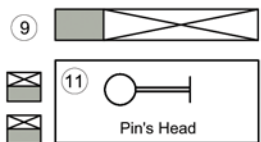
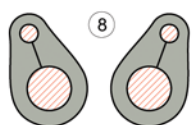

Wire Ø 0.8-1.0 mm

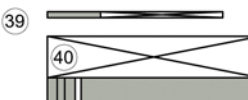
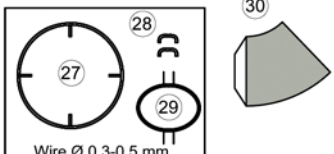
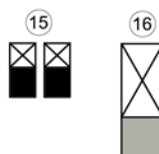
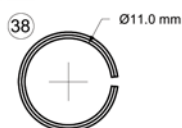

U-Boat Type VIIC 1/72 Scale

W 70 grms

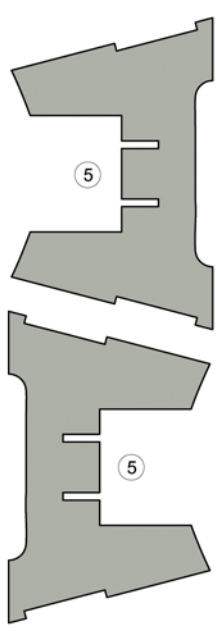
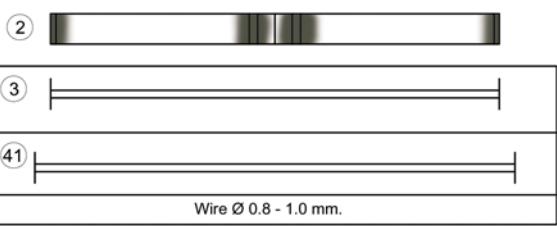
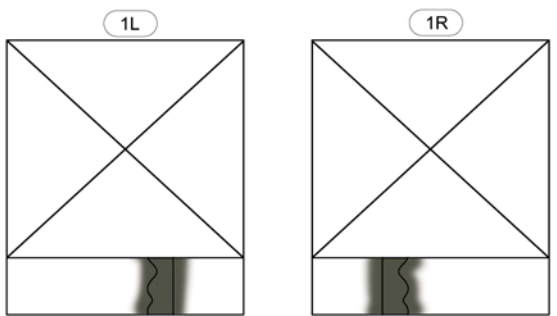

Part No. 4,5,6 and 7 need to be laminated to 1mm card board.

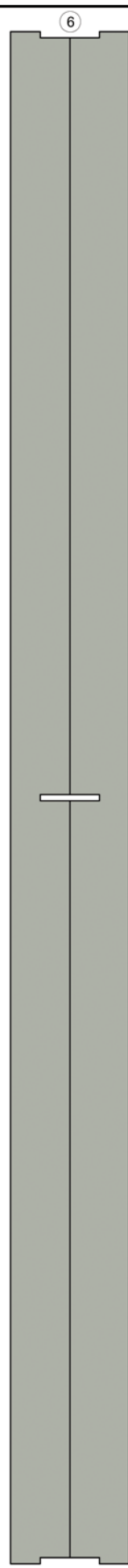
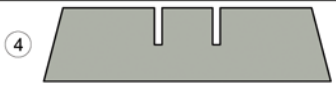

U-Boat Type VII C
U-Boat Type VII C

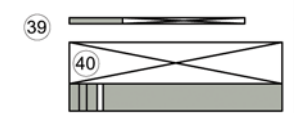
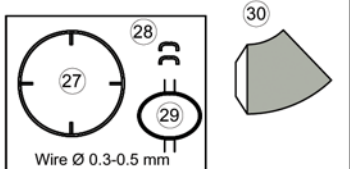
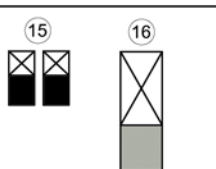
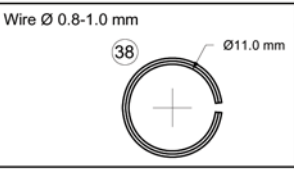
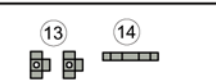
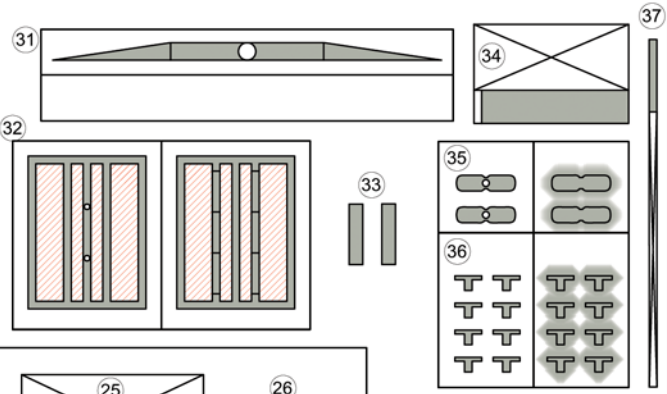
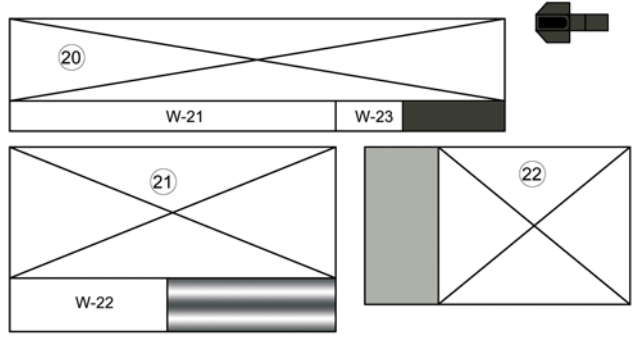
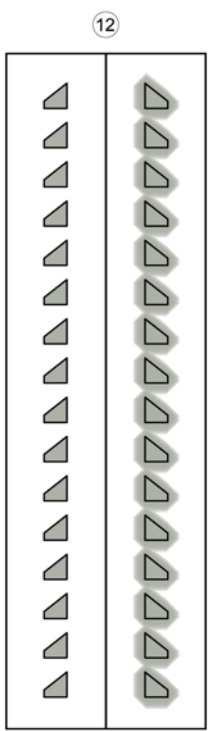
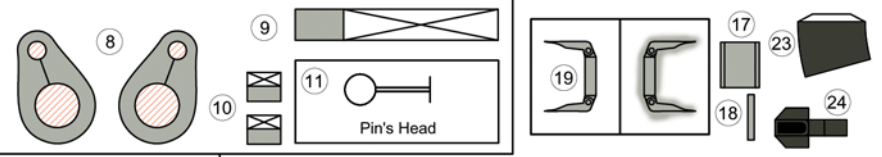

U-Boat Type VIIC 1/72 Scale

M

190 grms

1L



2L

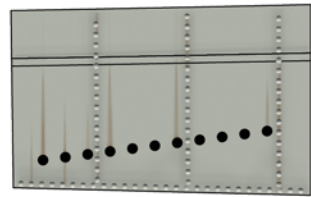

1R



2R

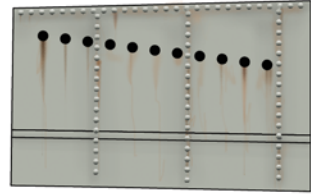

3



4

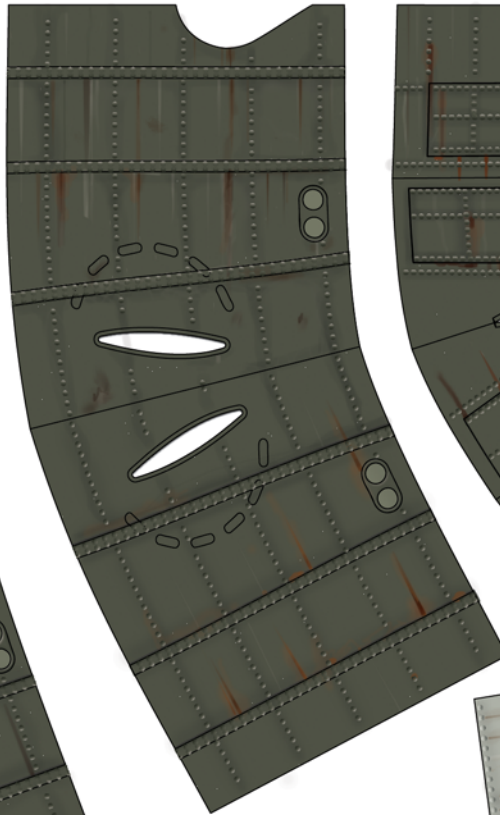

5

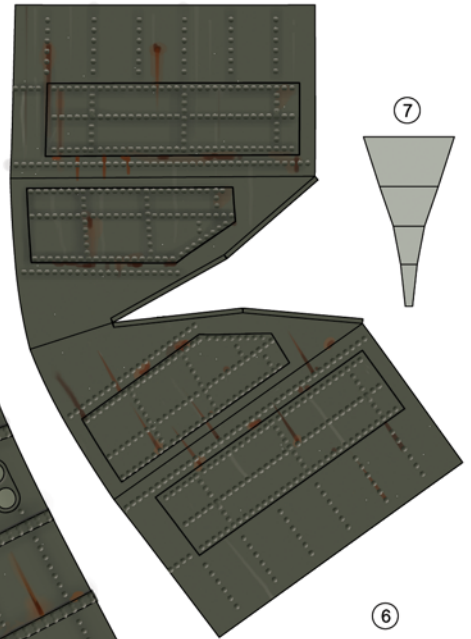

7

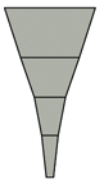

6



11

12L

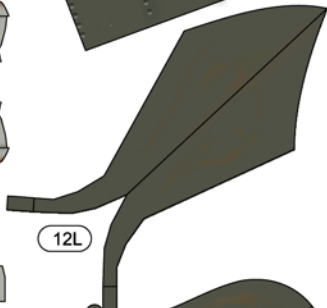

13L

13R

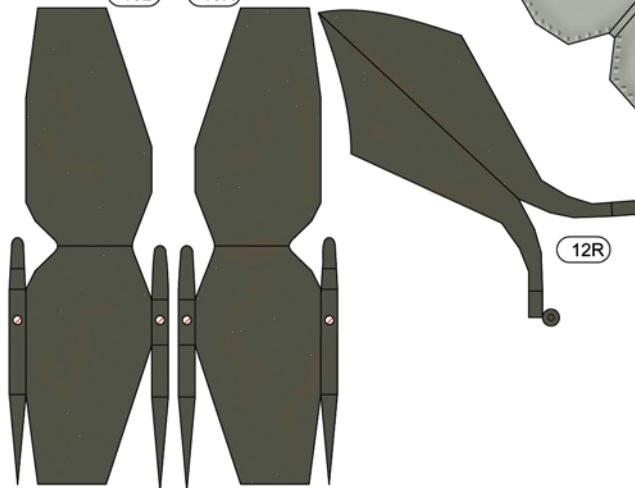

12R

10



9



8

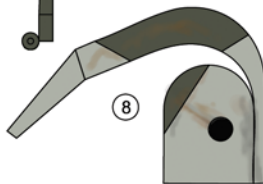

U-Boat Type VIIC 1/72 Scale

Q

190 grms

5L

4L

3L

2L

1L

1R

2R

3R

4R

5R

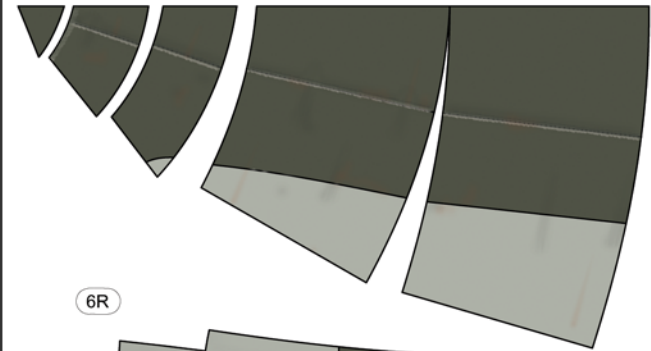
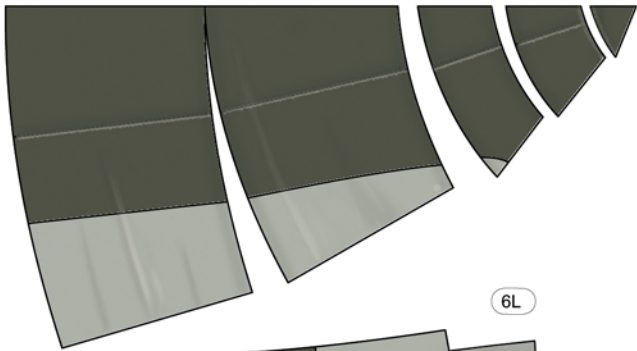

6L

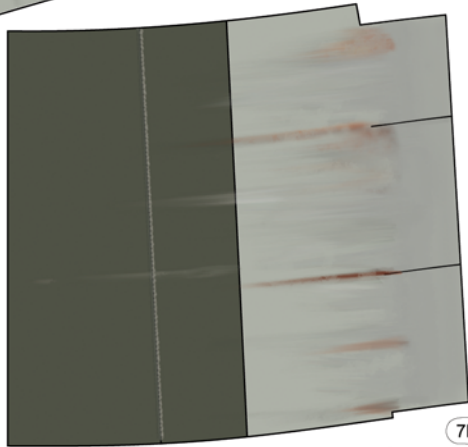

6R

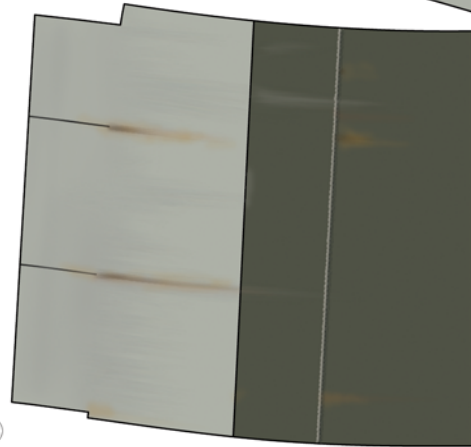

7L

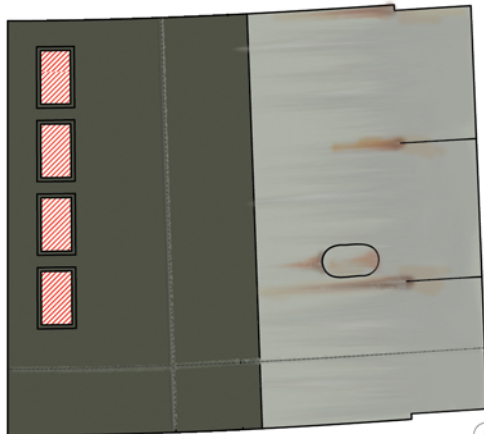

7R

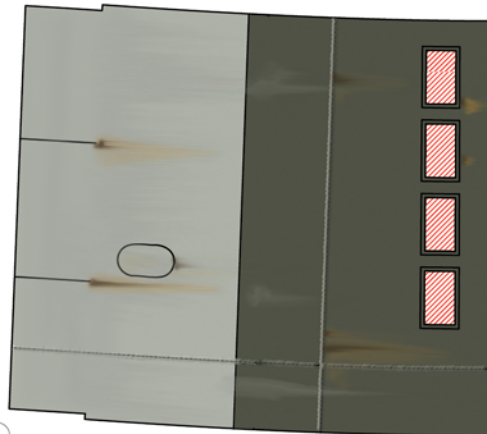

8L

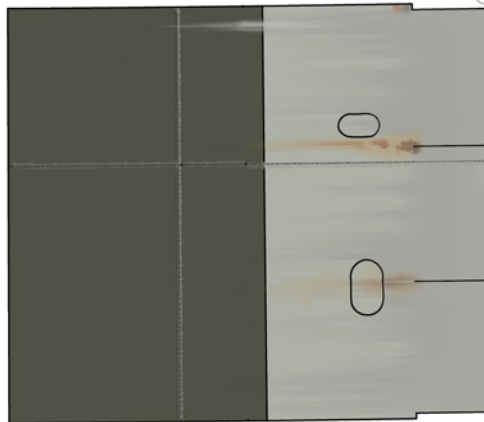

8R

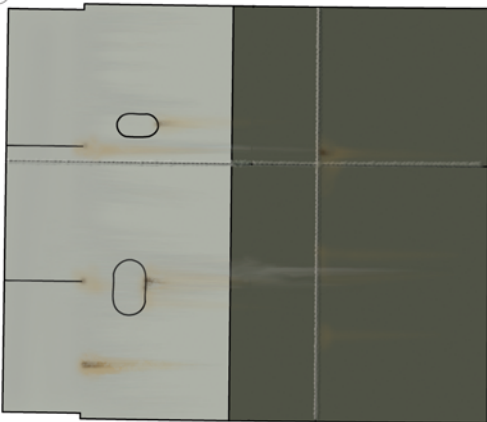

10L



9L



8L



8R



9R



10R



12R



U-Boat Type VIIC 1/72 Scale

Q

190 grms

5L

4L

3L

2L

1L

1R

2R

3R

4R

5R

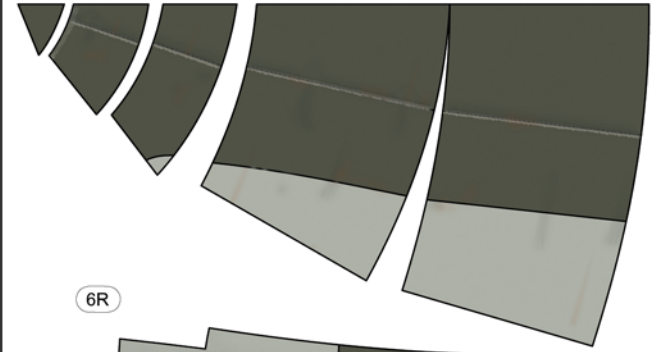
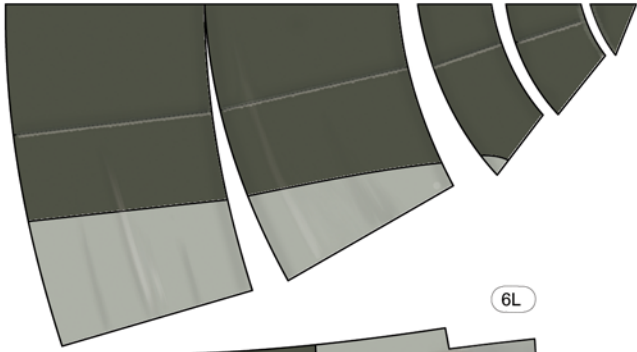

6L

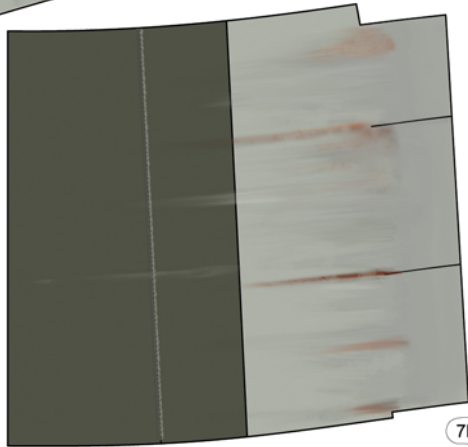

6R

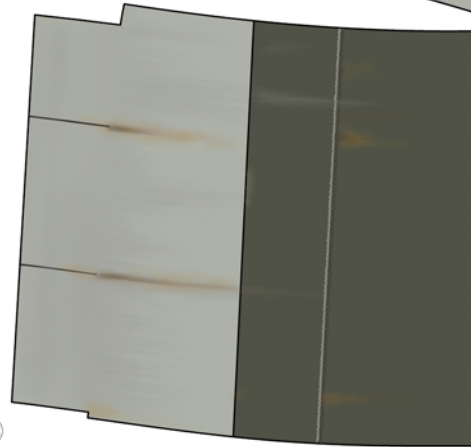

7L

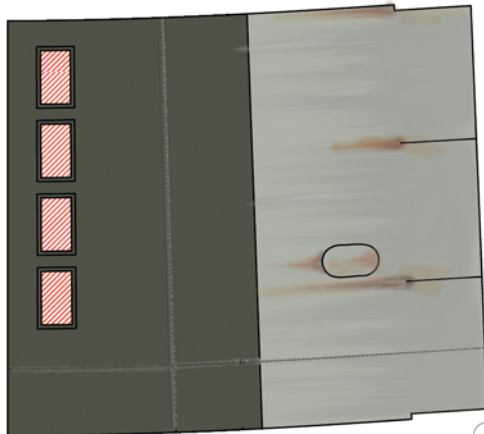

7R

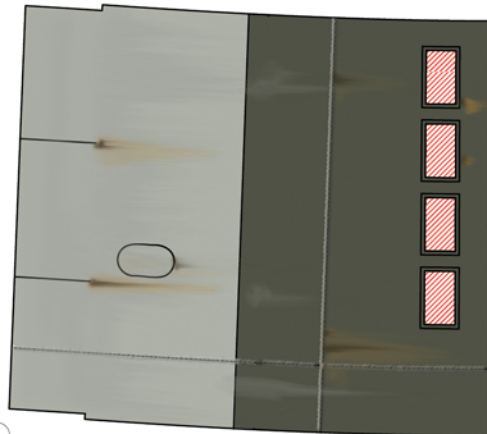

8L

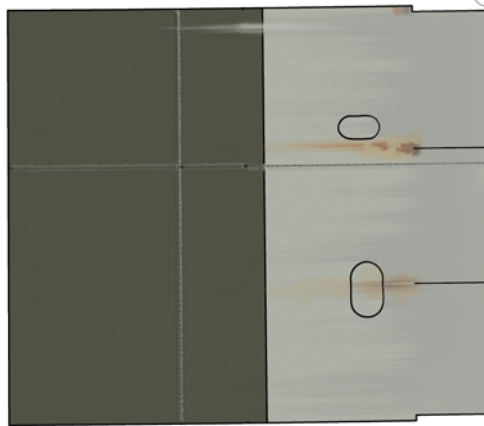

8R

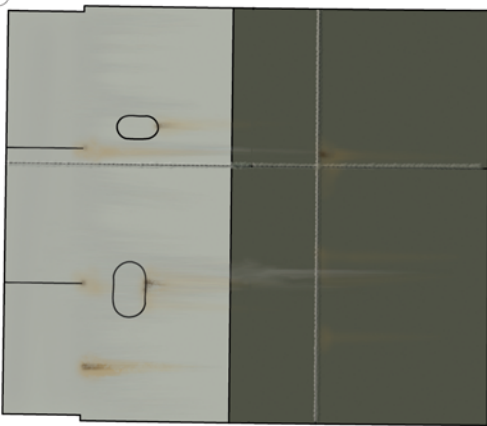

10L



9L



8L



8R



9R



10R



U-Boat Type VIIC 1/72 Scale

R

190 grms

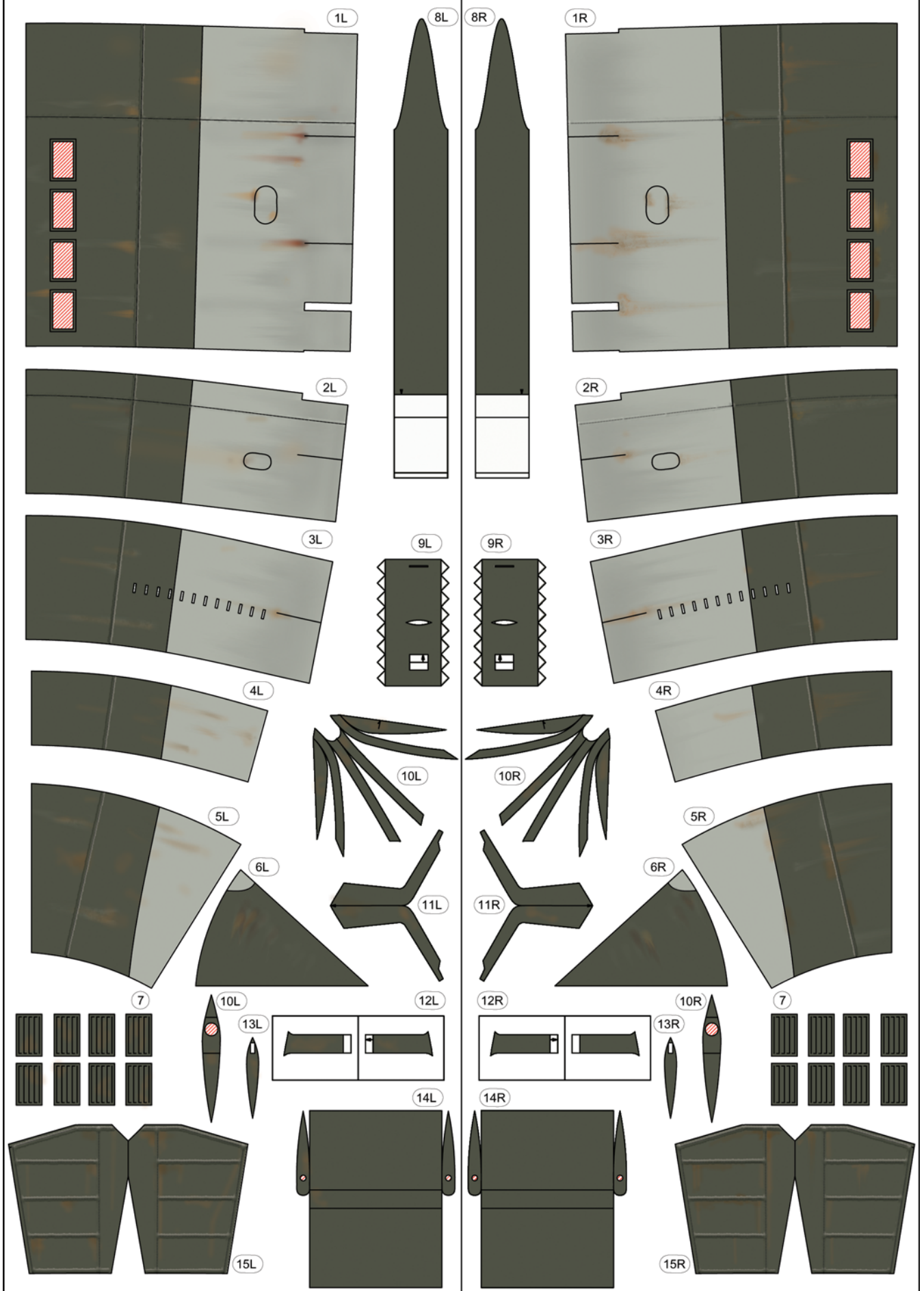

U-Boat Type VIIC 1/72 Scale

W

70 grms

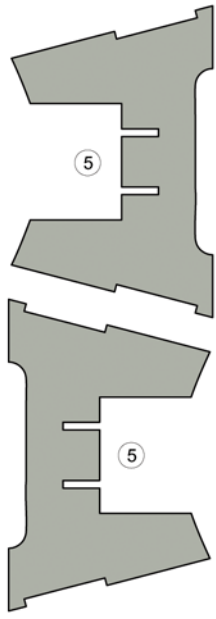
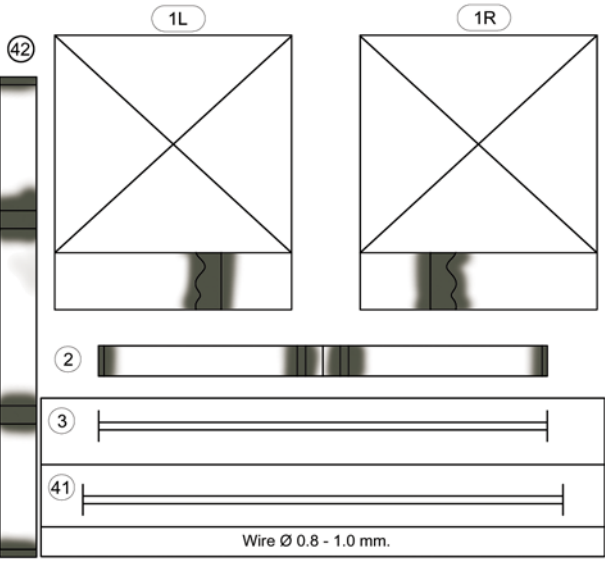

Part No. 4, 5, 6 and 7 need to be laminated to 1mm card board.

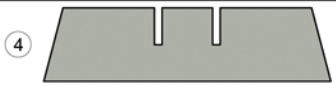

U-Boat Type VII C
U-Boat Type VII C

