

U-Boat Type VIIC 1/72 Scale

A

70 grms + 1 mm CardBoard

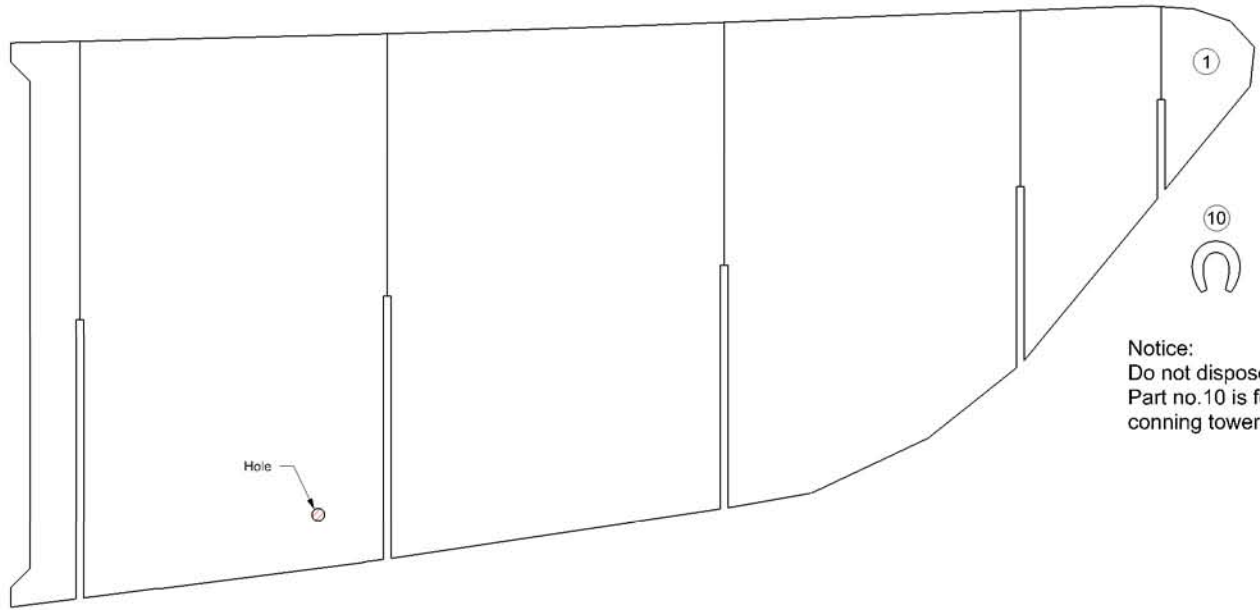

Notice:
Do not dispose!
Part no.10 is for
conning tower.

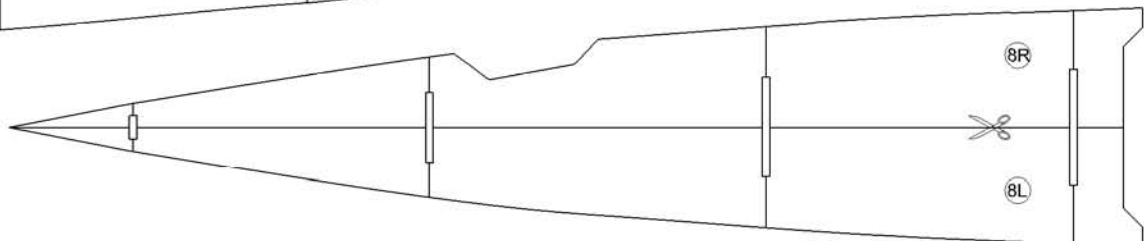
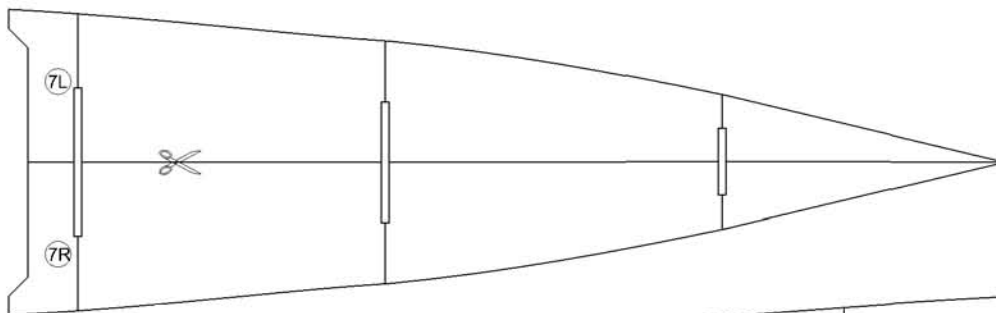
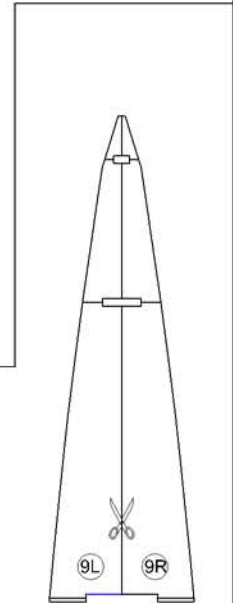
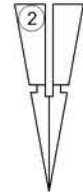
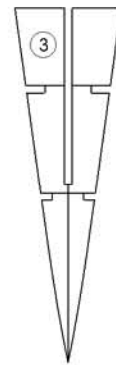
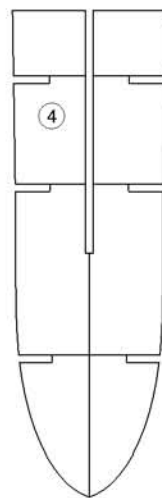
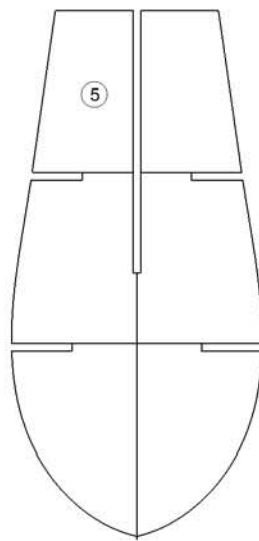
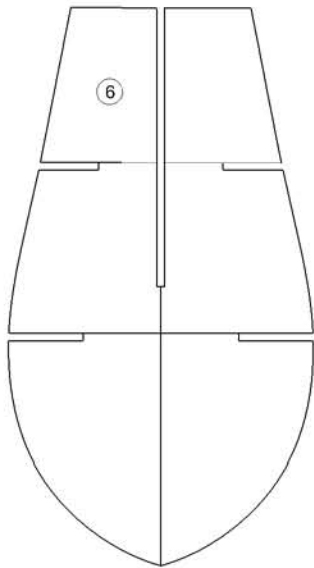

U-Boat Type VIIC 1/72 Scale

B

70 grms + 1 mm CardBoard

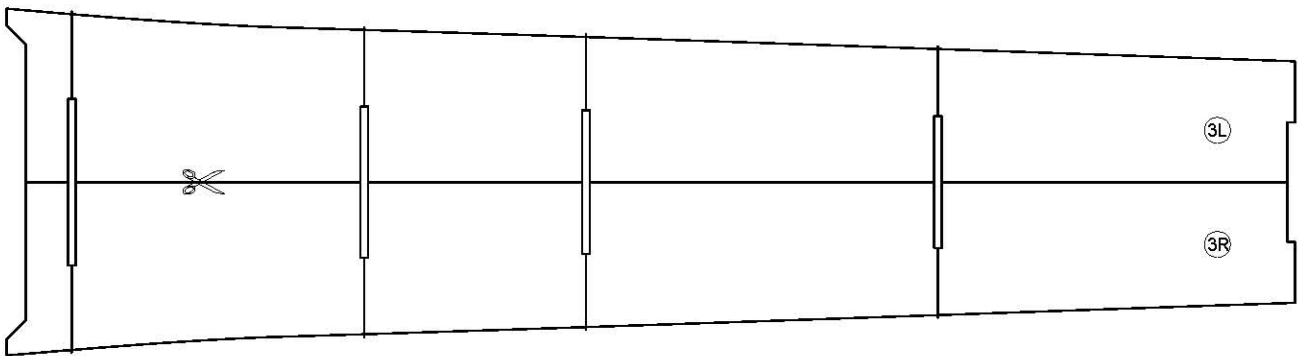
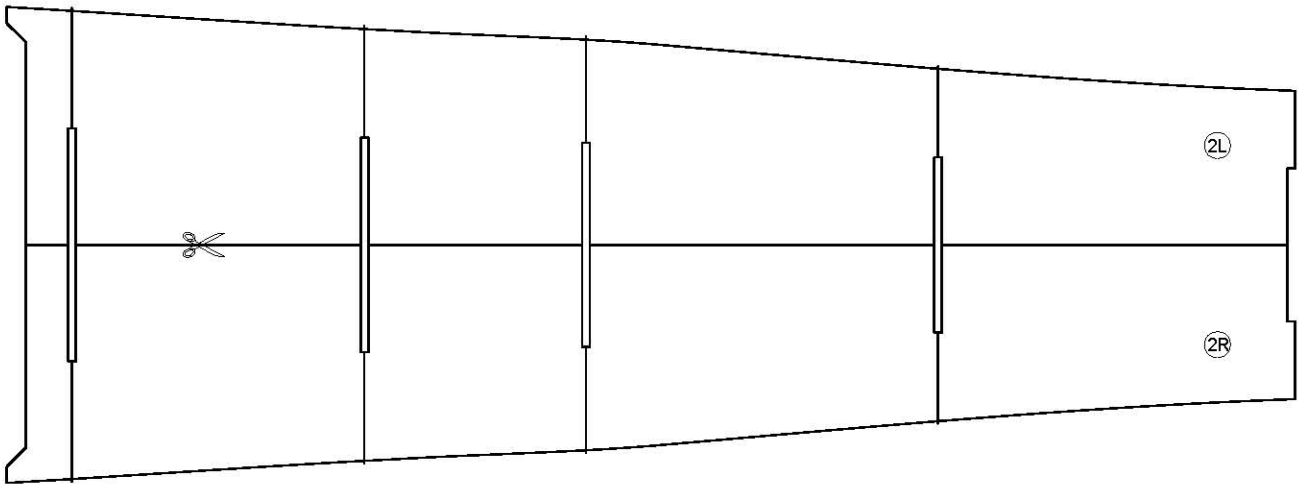
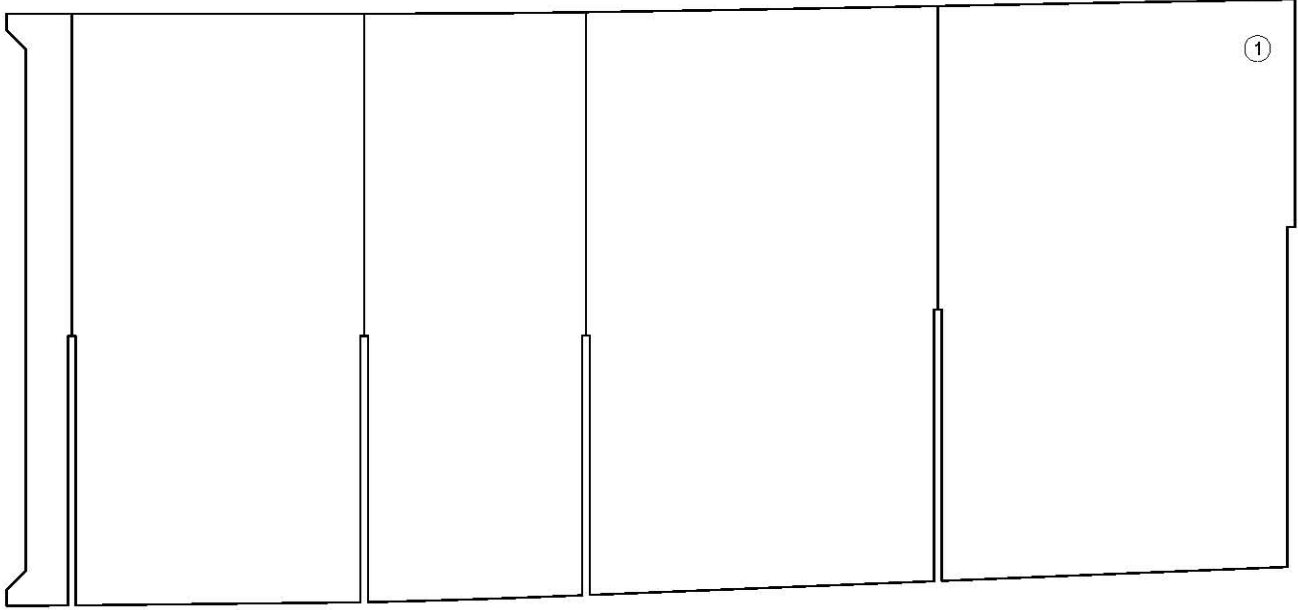

U-Boat Type VIIC 1/72 Scale

C

70 grms + 1 mm CardBoard

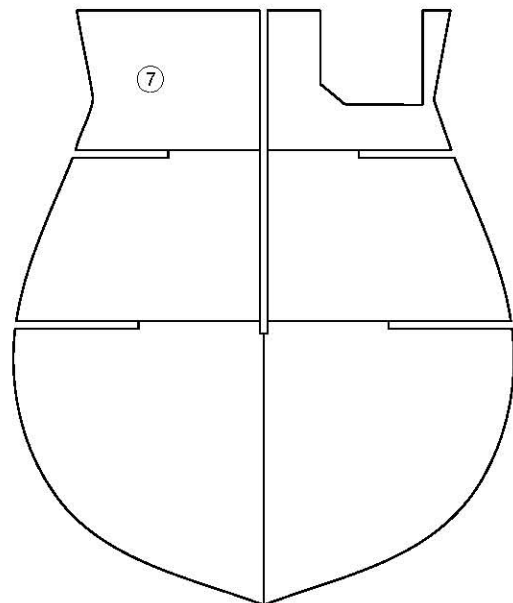
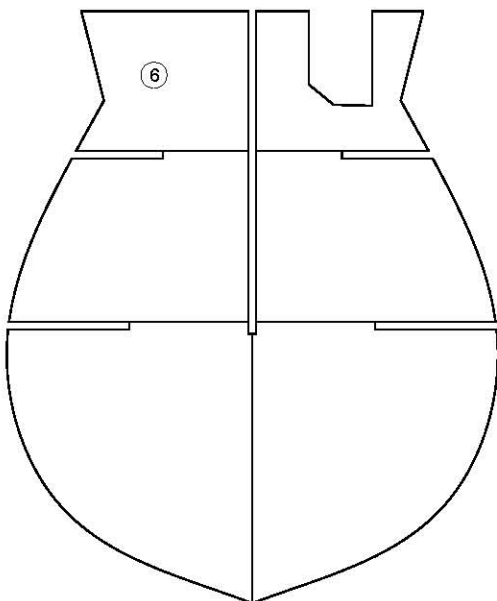
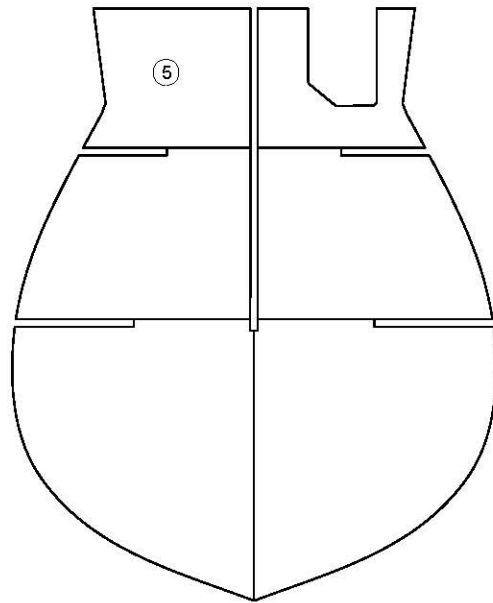
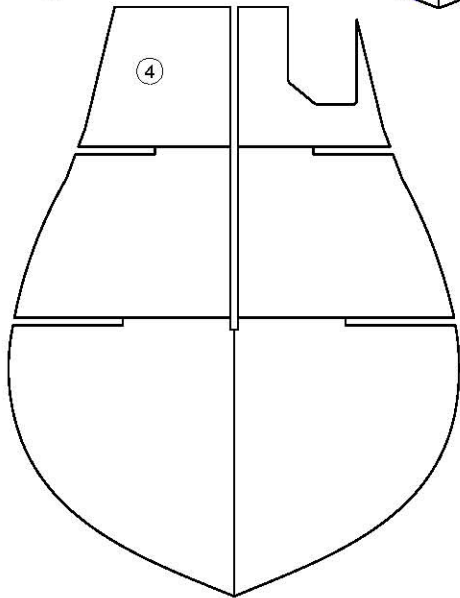
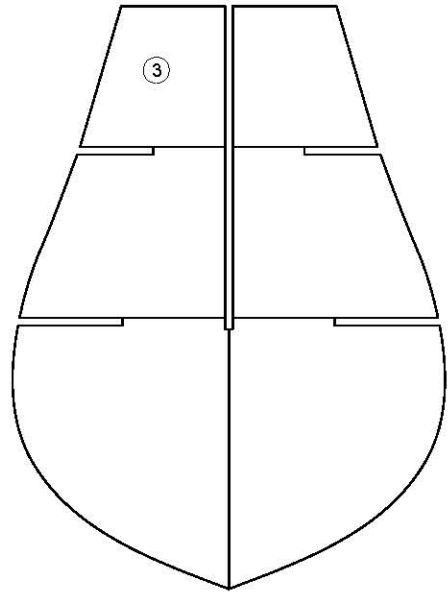
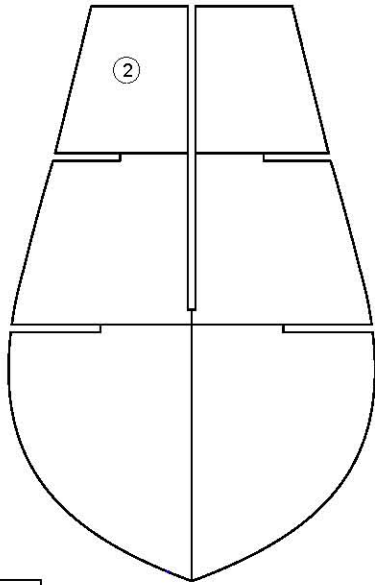
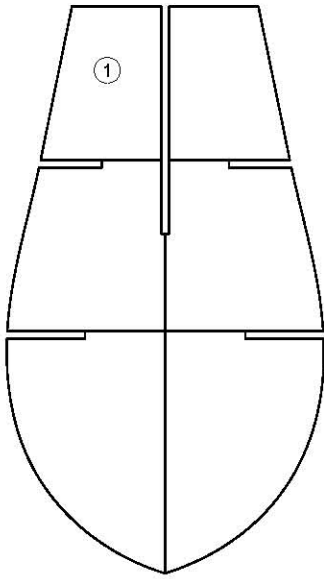

U-Boat Type VIIC 1/72 Scale

D

90 grms + 1 mm CardBoard

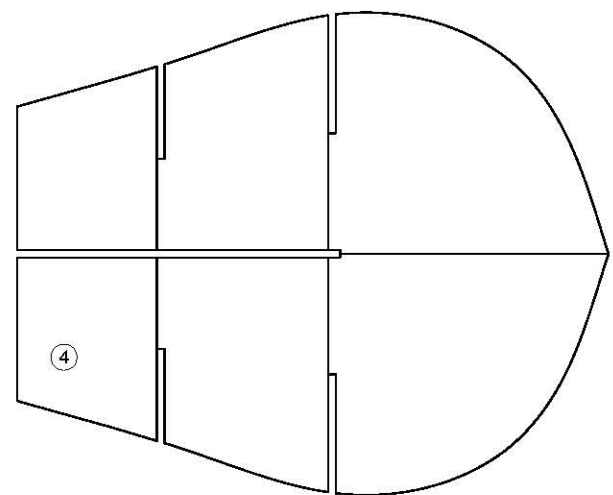
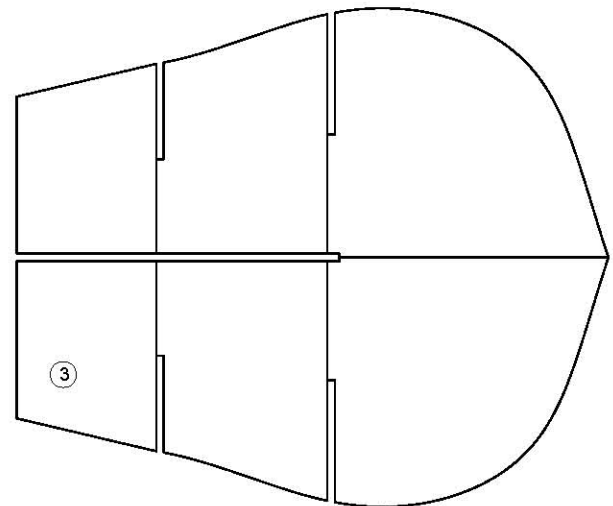
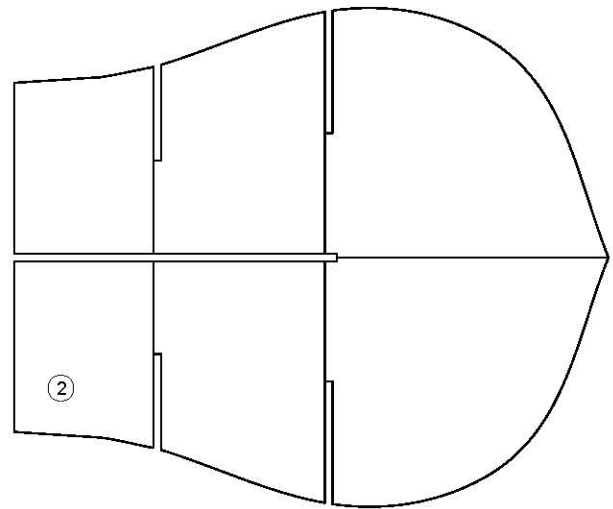
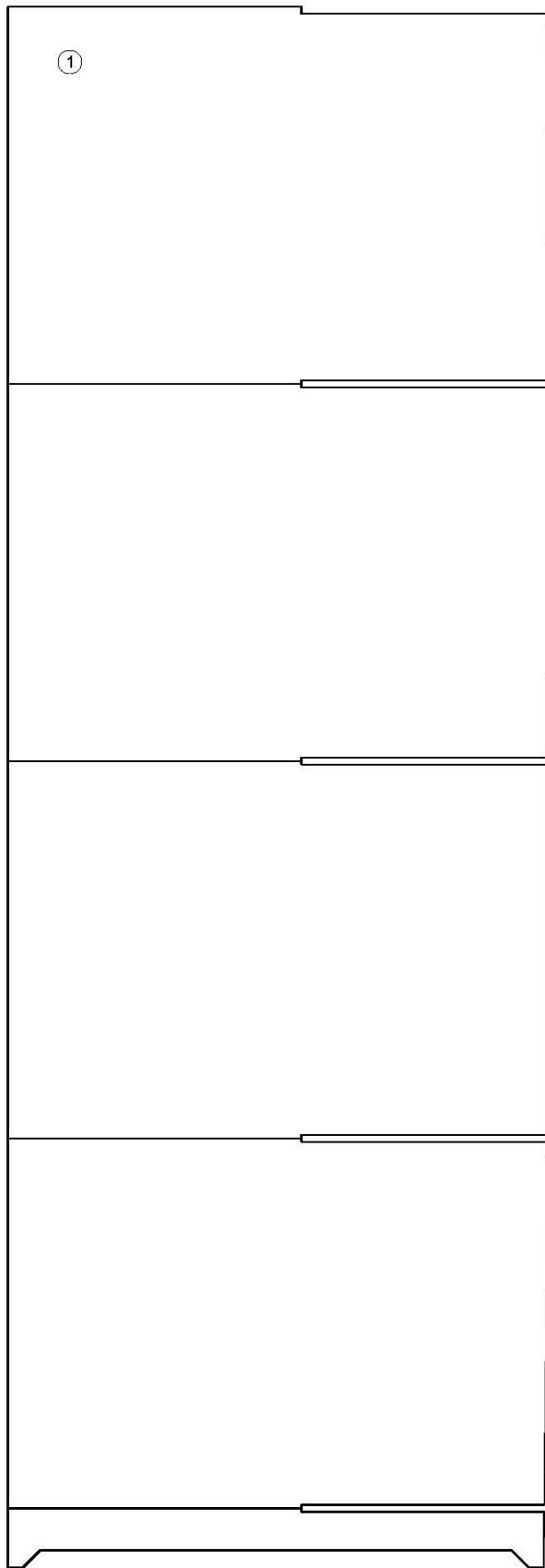

U-Boat Type VIIC 1/72 Scale

E

70 grms + 1 mm CardBoard

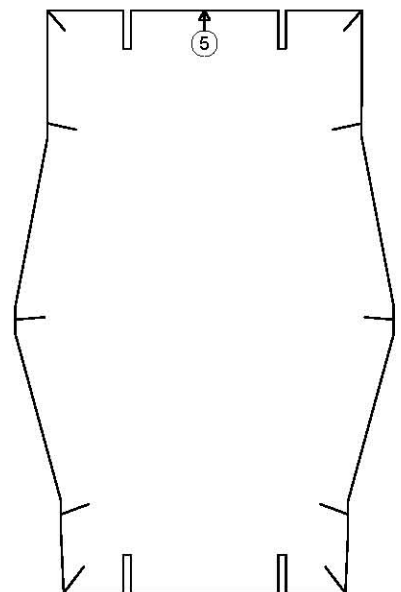
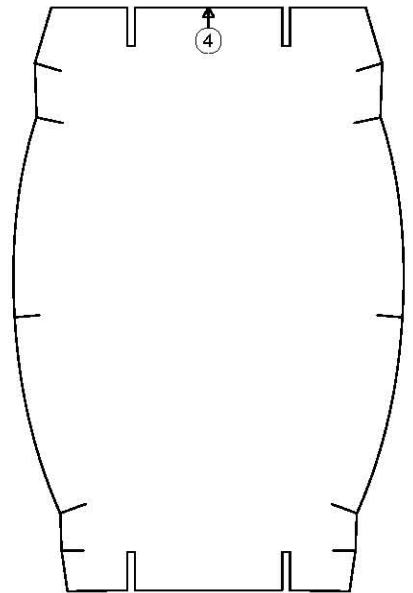
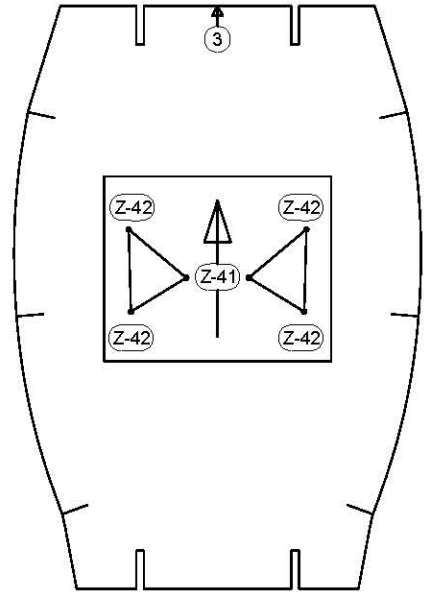
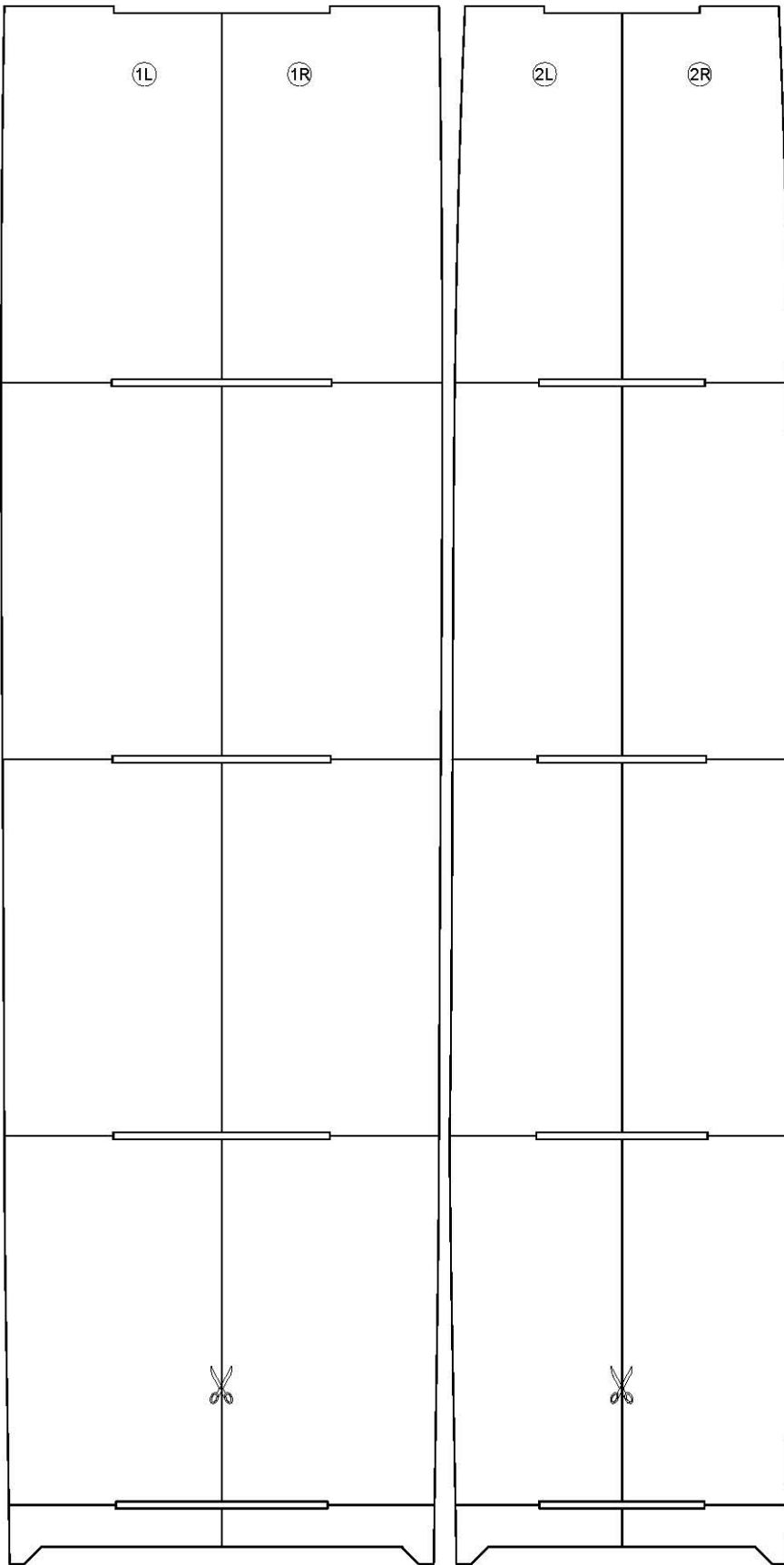

U-Boat Type VIIC 1/72 Scale

F

70 grms + 1 mm CardBoard

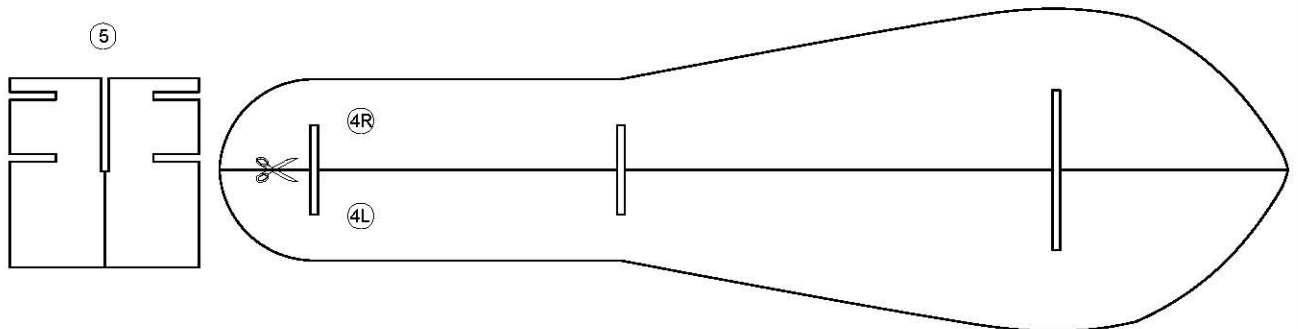
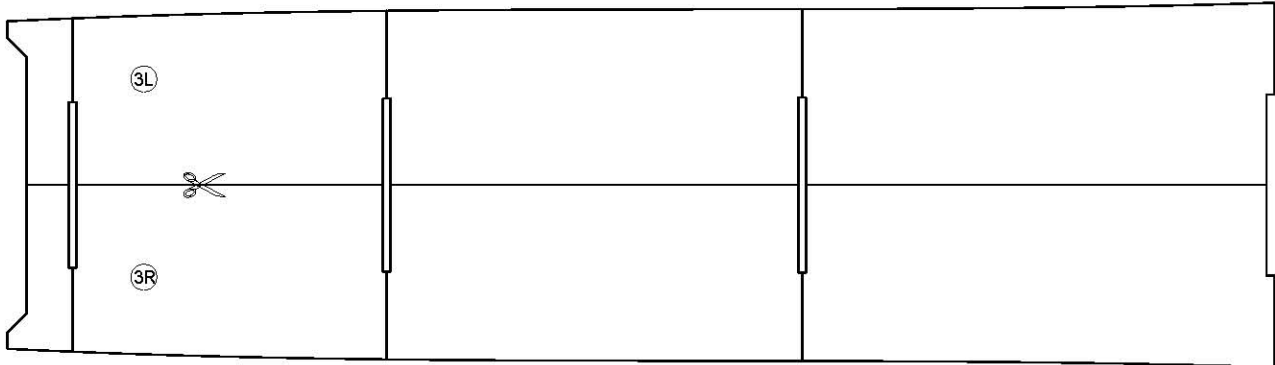
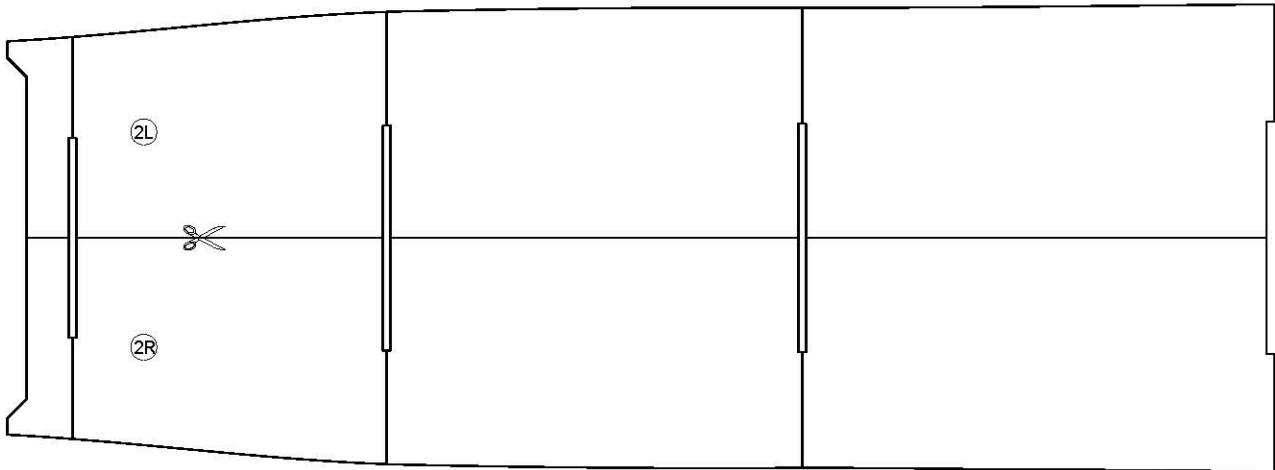
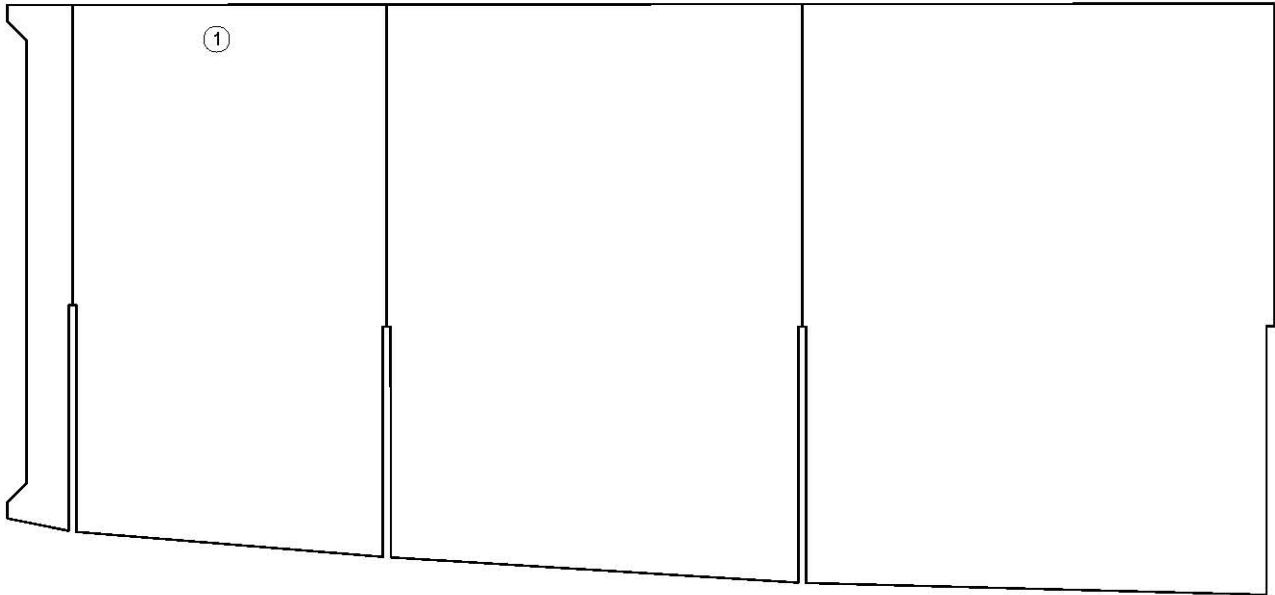

U-Boat Type VIIC 1/72 Scale

G

70 grms + 1mm Cardboard

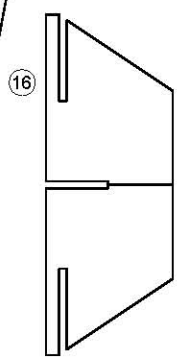
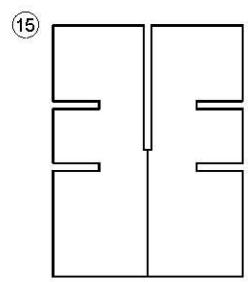
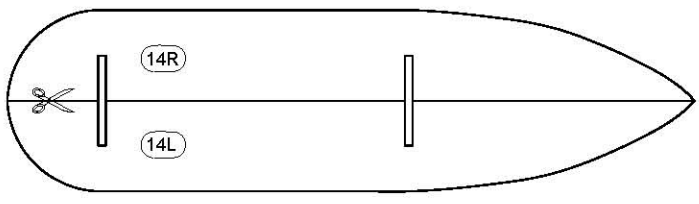
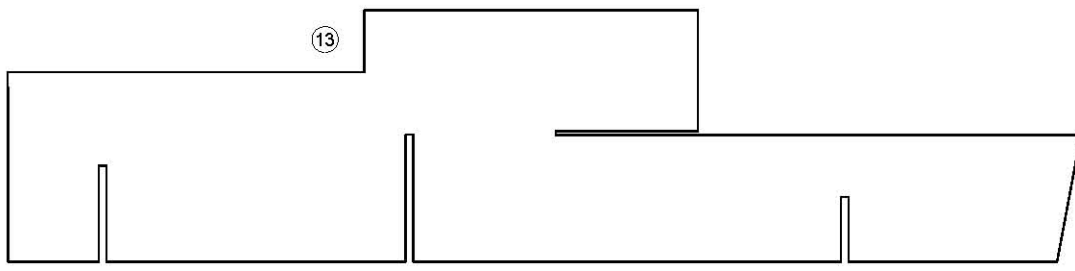
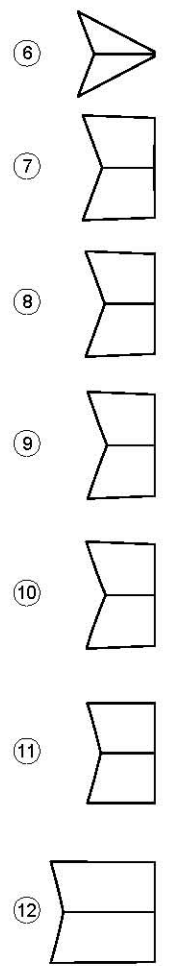
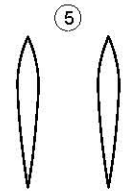
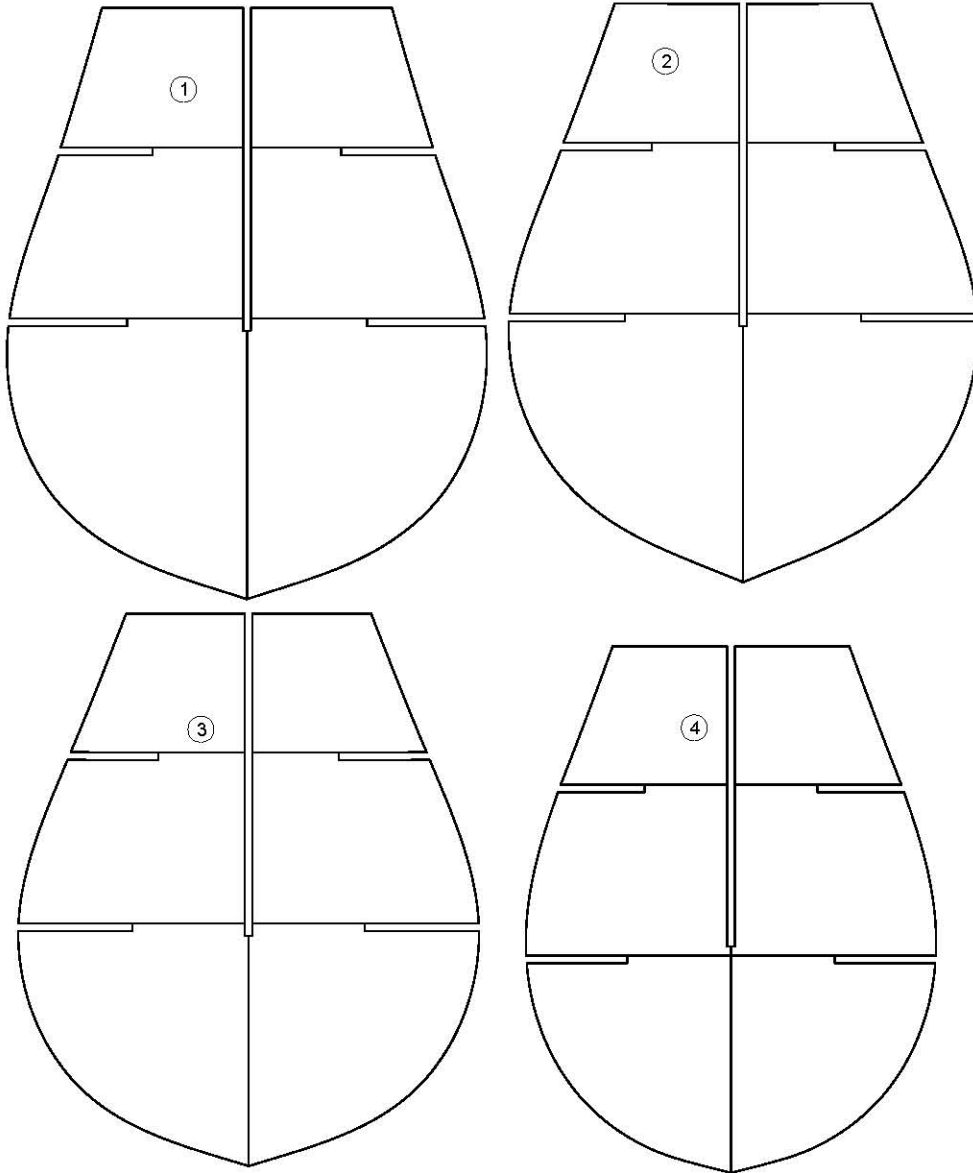

U-Boat Type VIIC 1/72 Scale

H

70 grms + 1 mm CardBoard

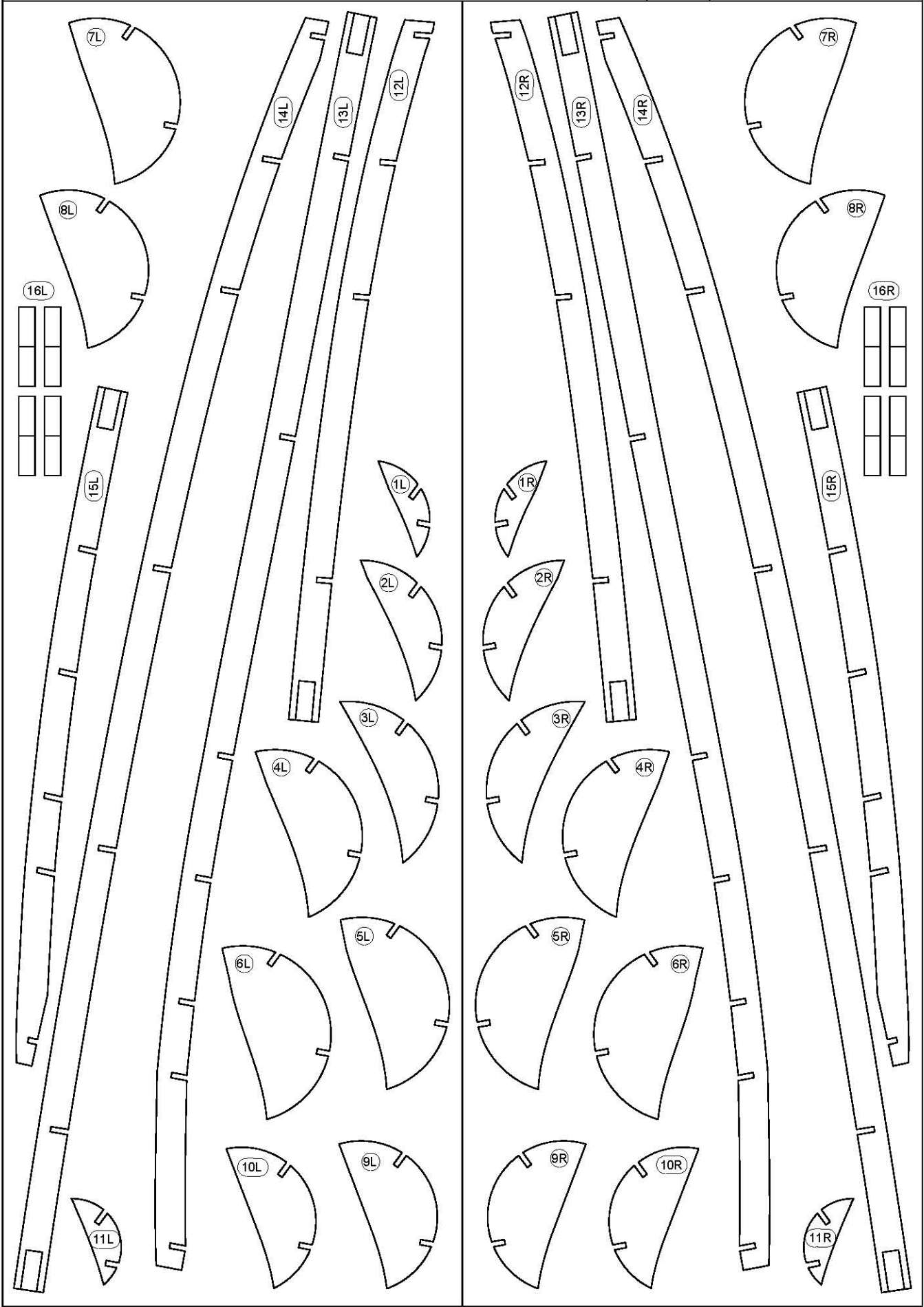

U-Boat Type VIIC 1/72 Scale

i

70 grms + 1 mm CardBoard

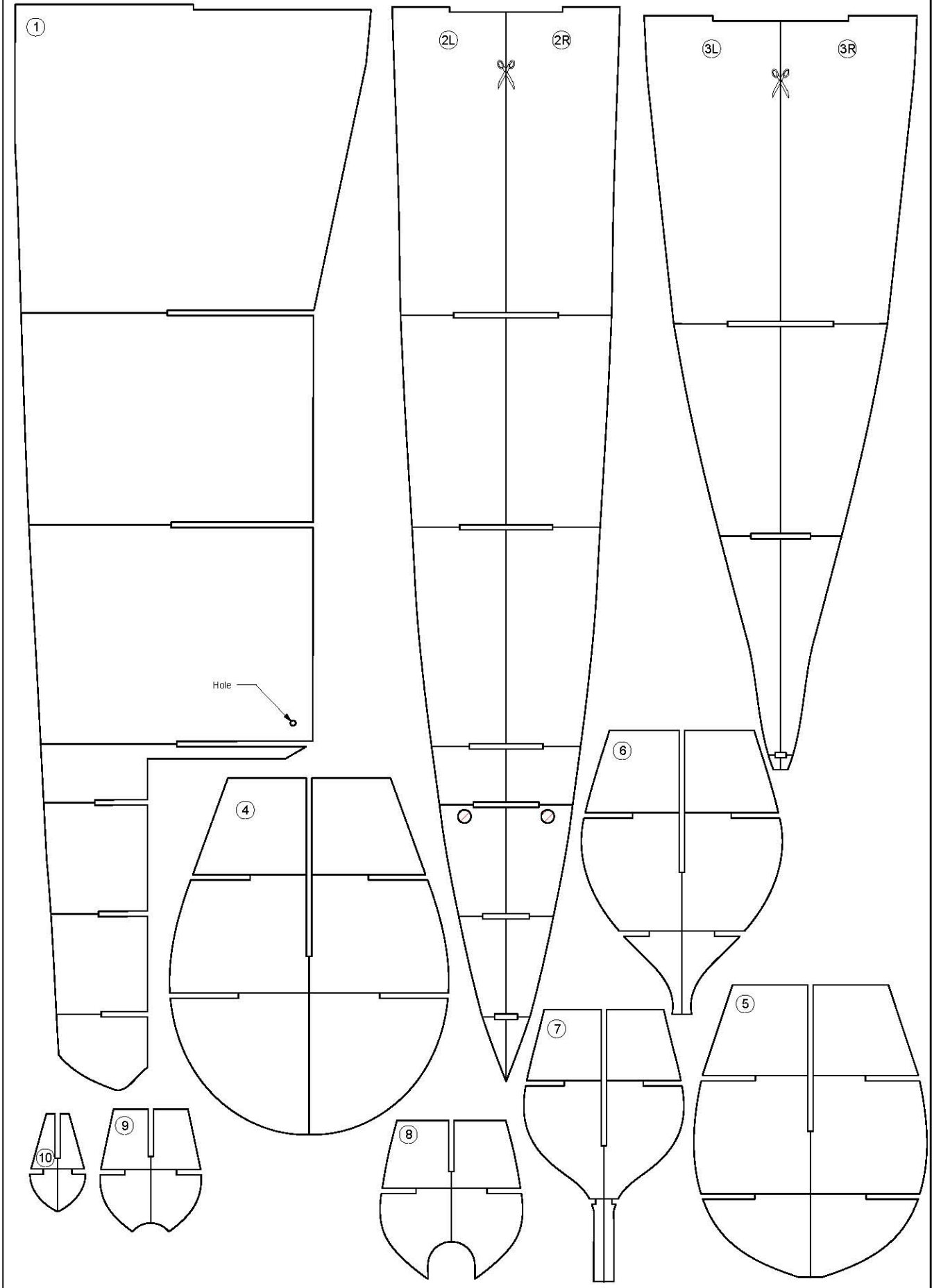

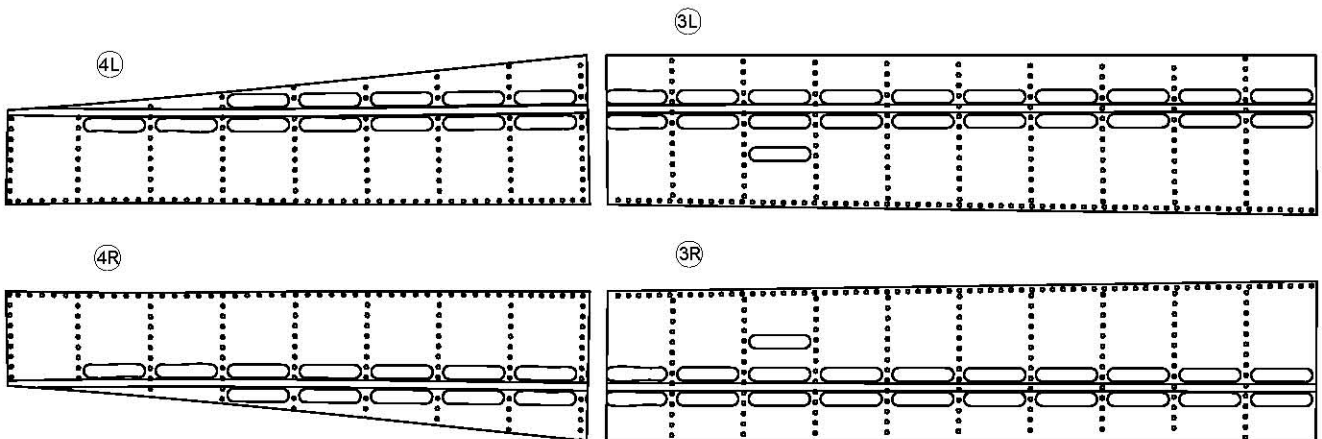
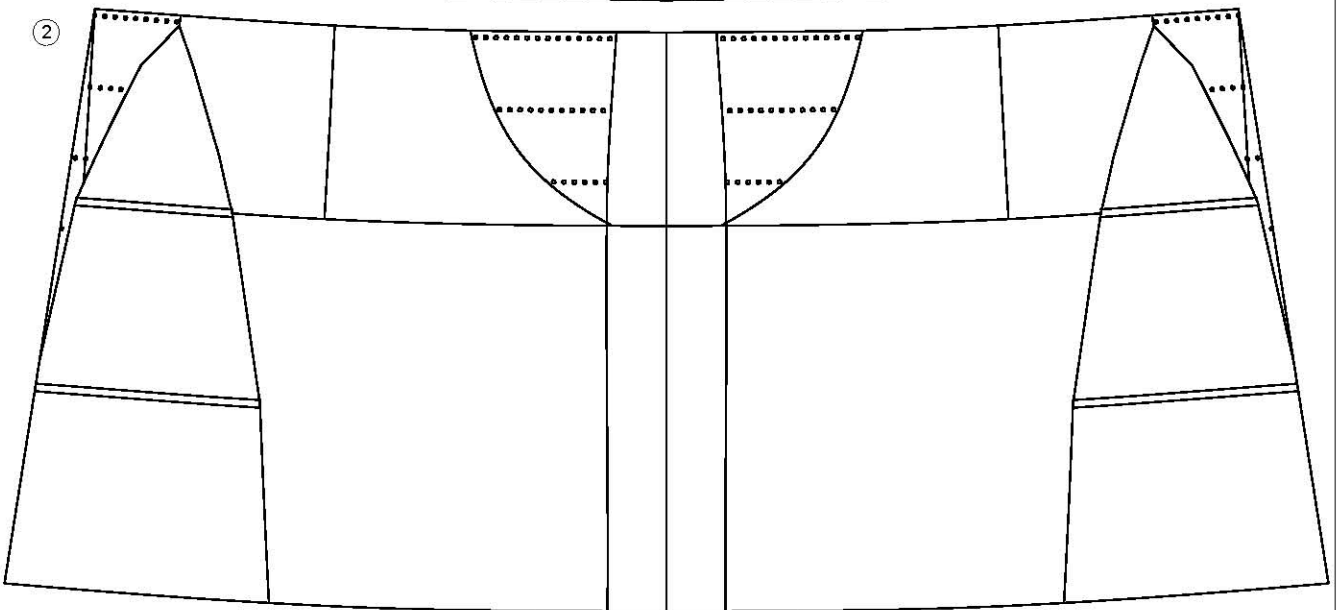
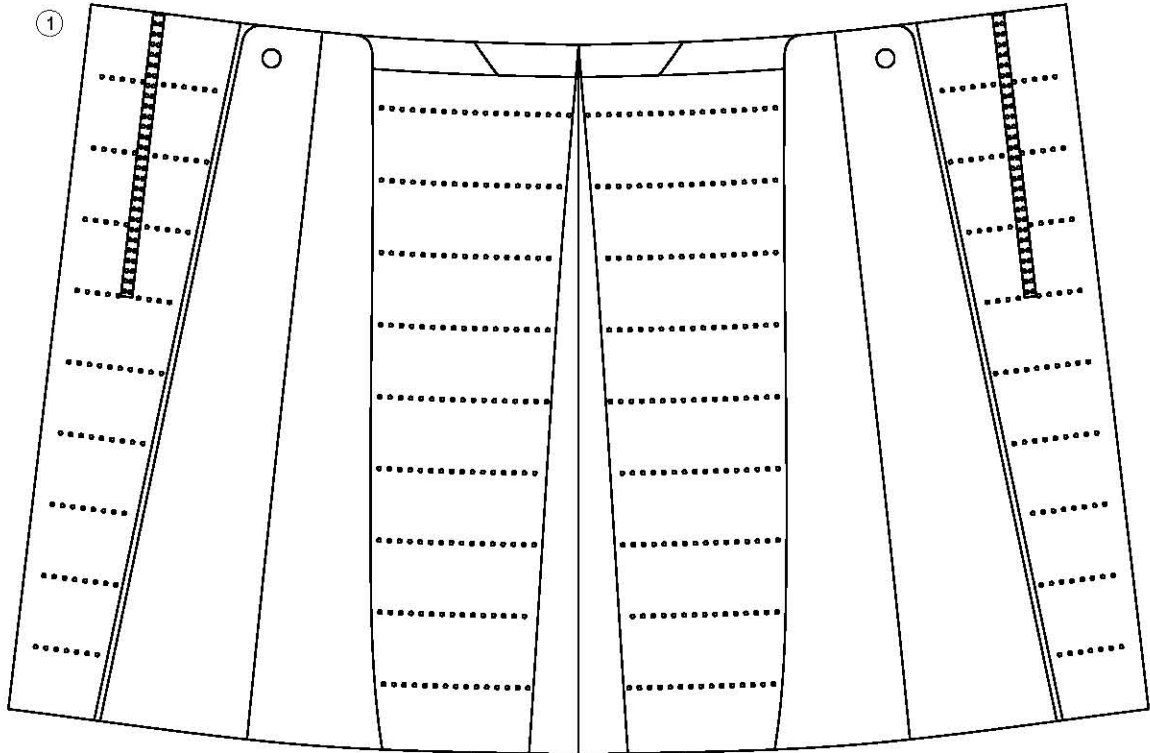

2R

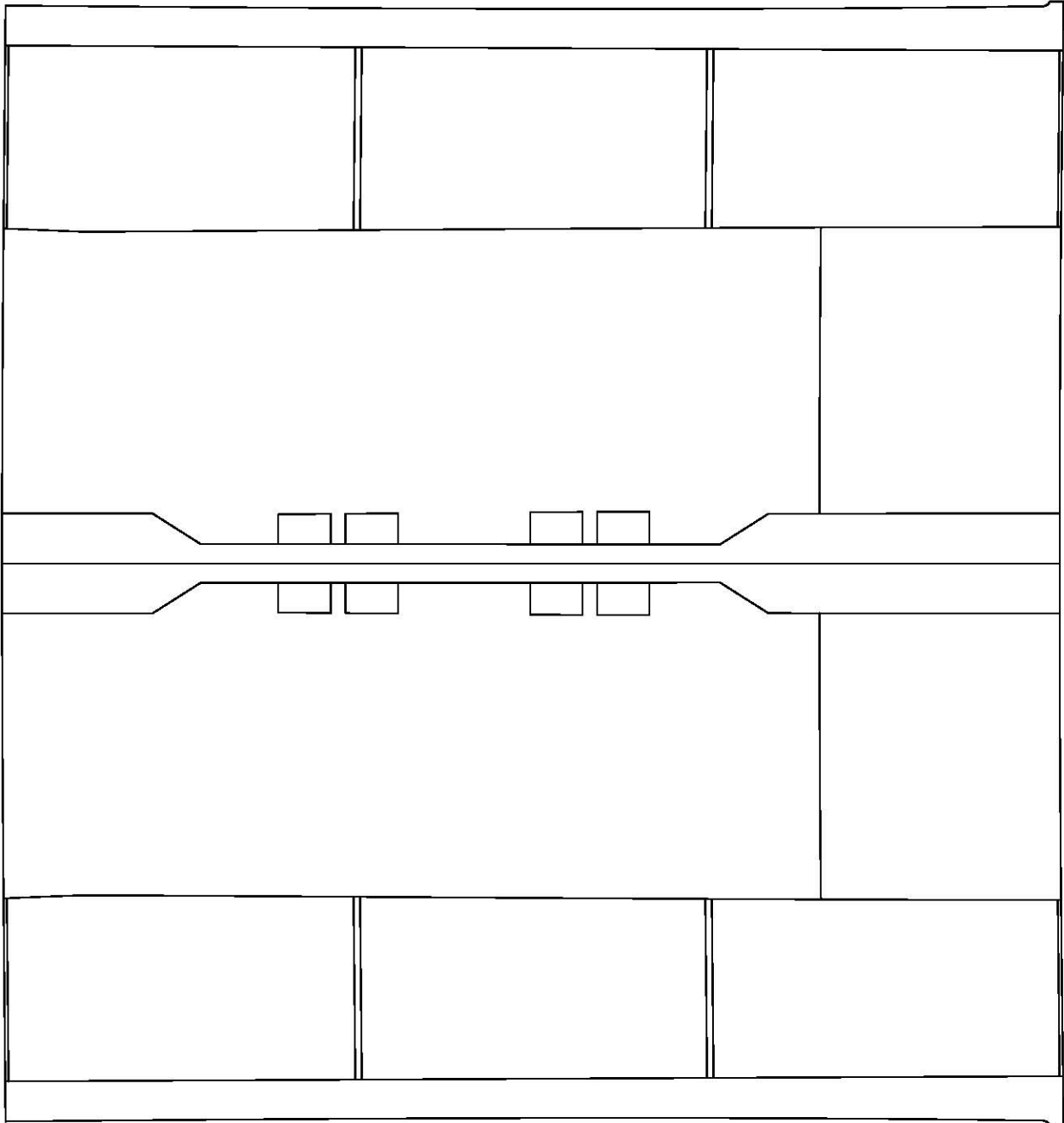
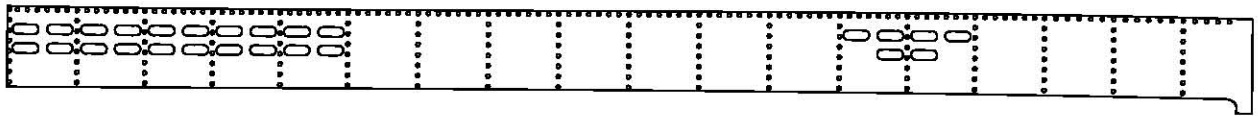

1

2L

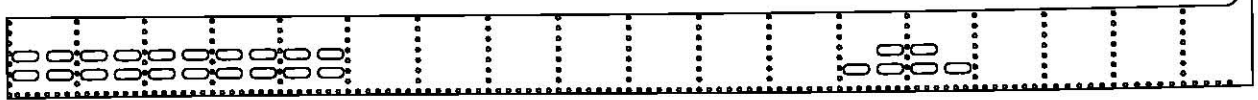

U-Boat Type VIIC 1/72 Scale

L

190 grms

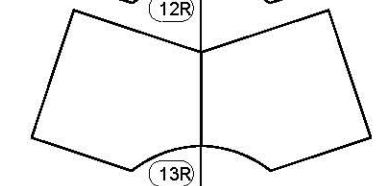
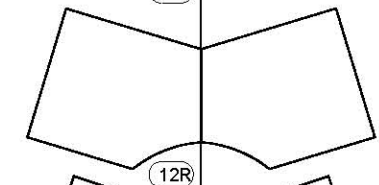
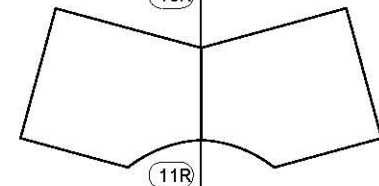
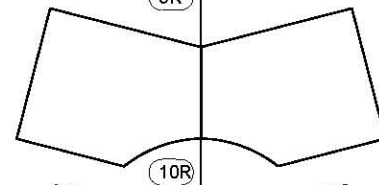
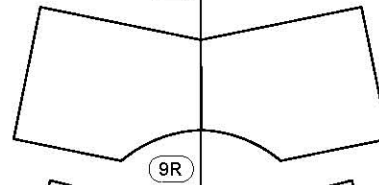
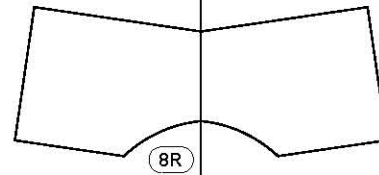
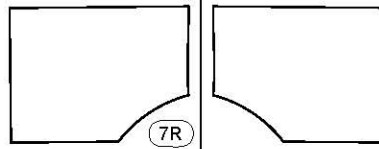
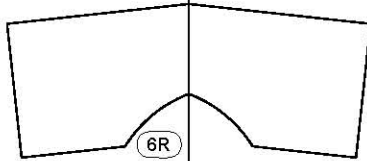
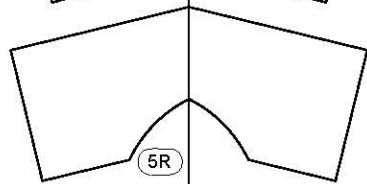
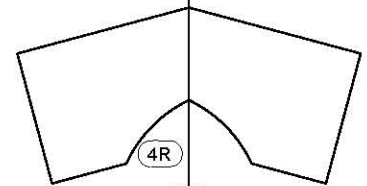
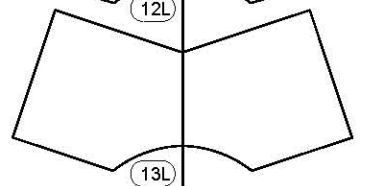
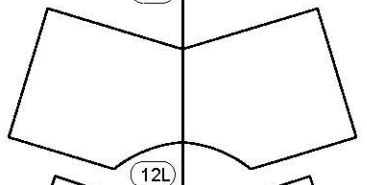
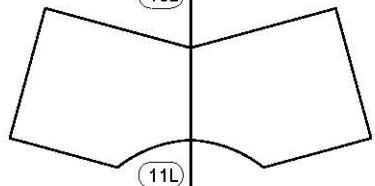
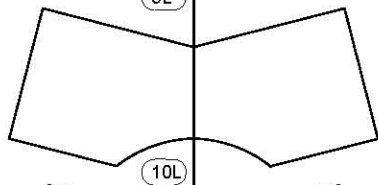
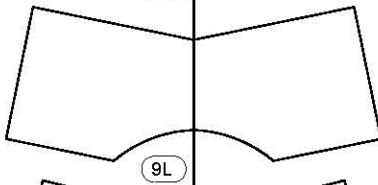
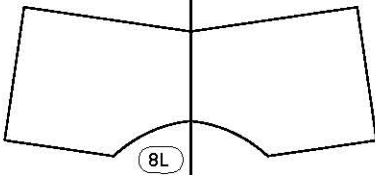
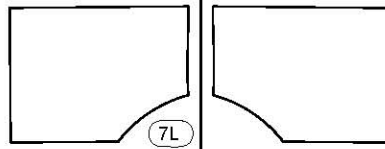
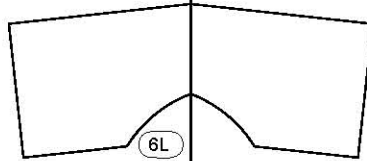
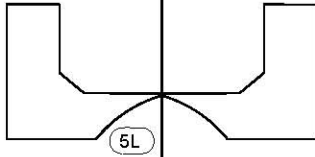
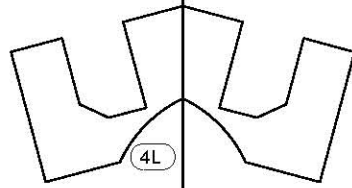
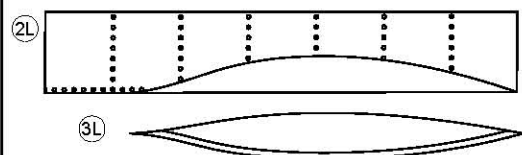
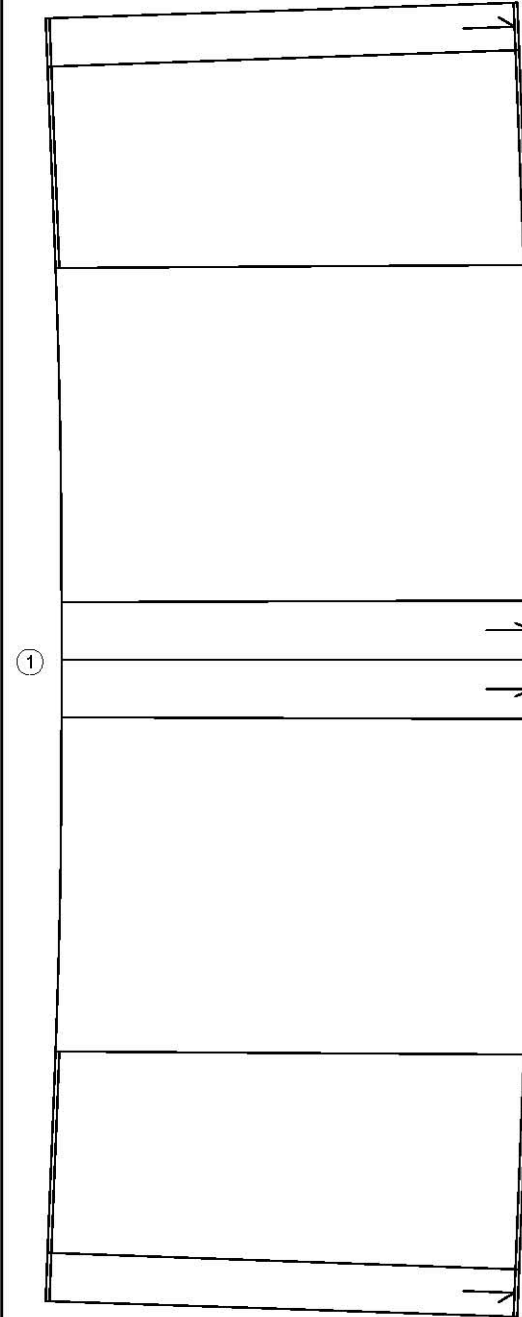
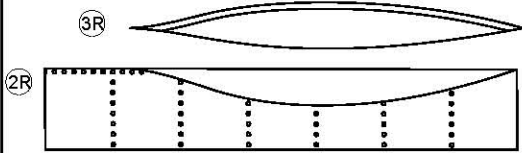

U-Boat Type VIIC 1/72 Scale

M

190 grms

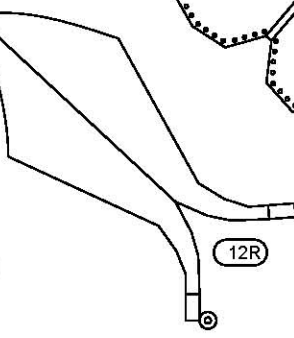
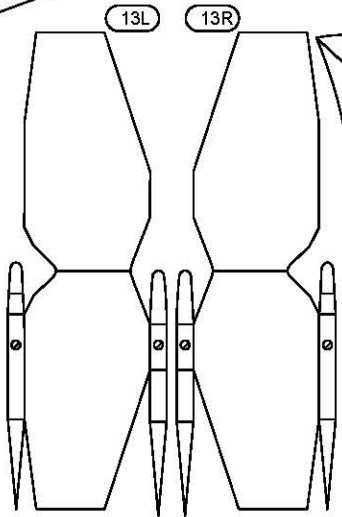
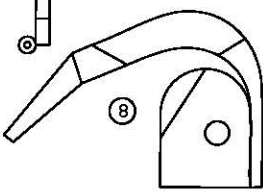
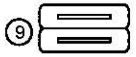
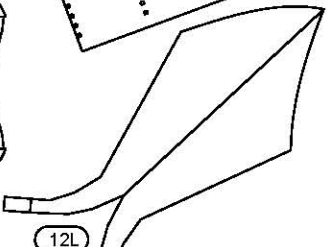
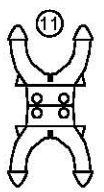
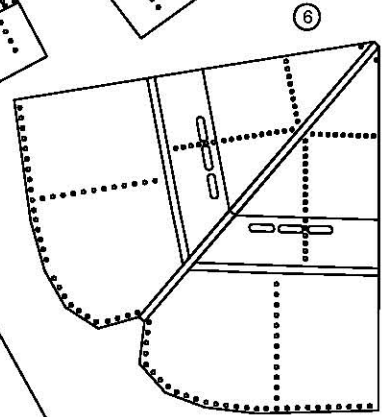
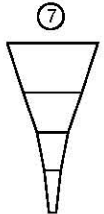
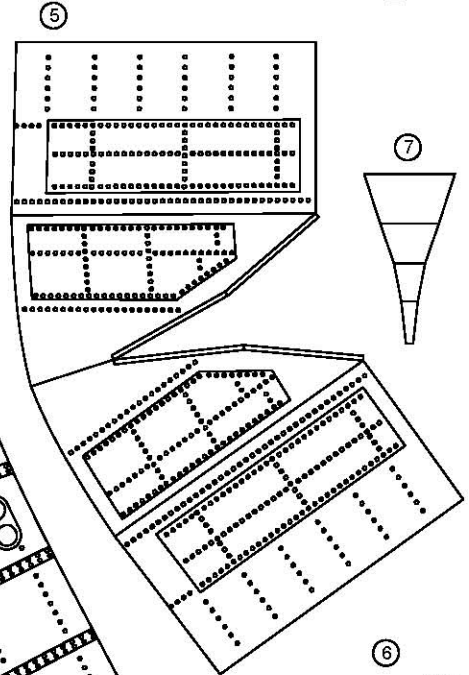
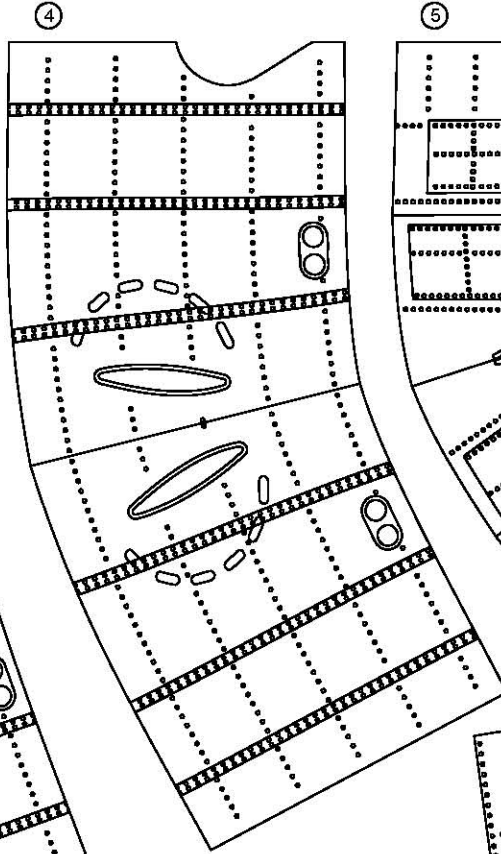
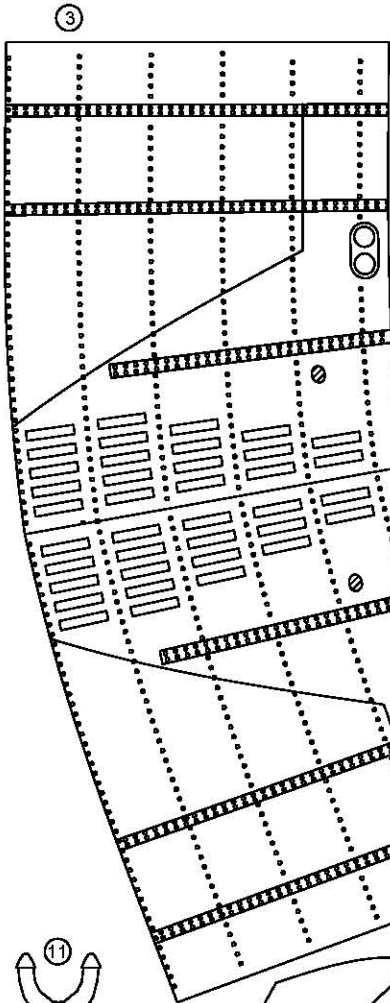
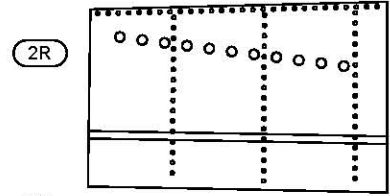
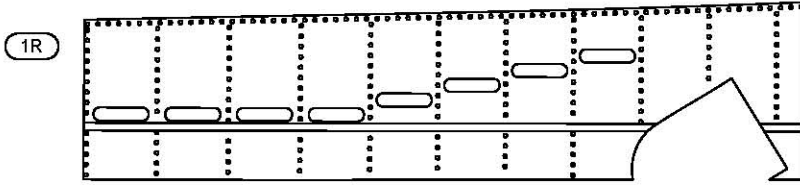
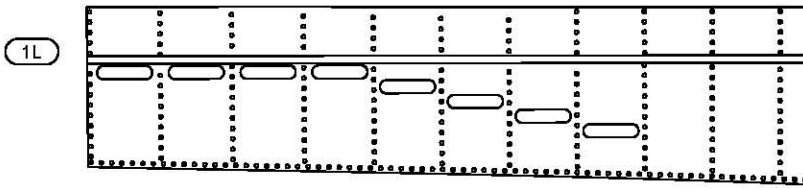

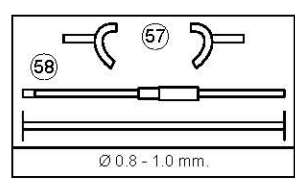
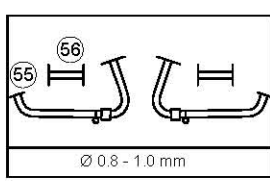
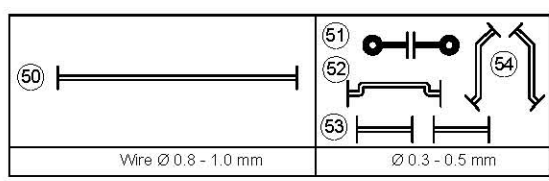
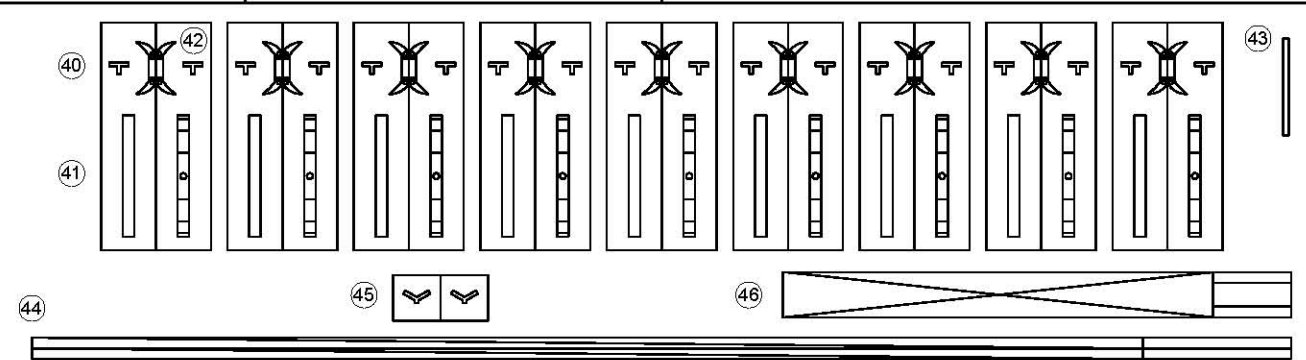
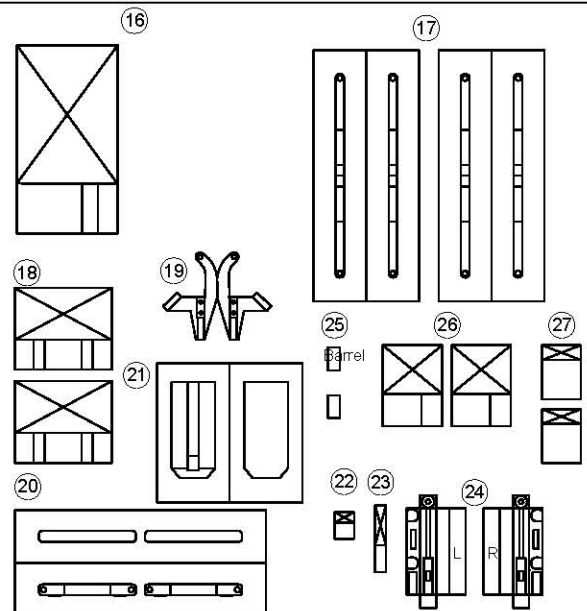
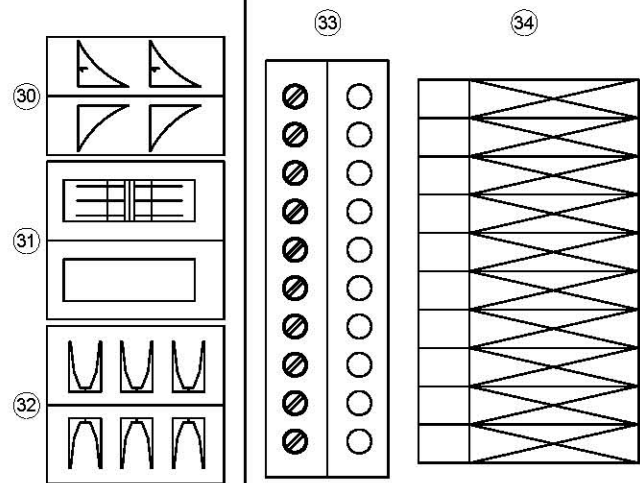
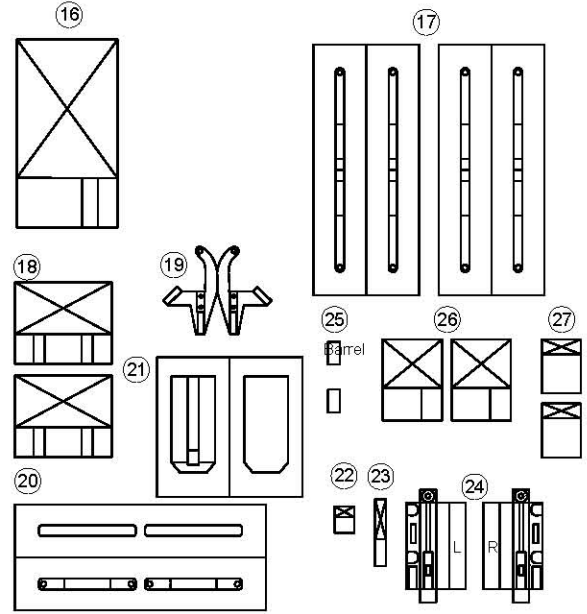
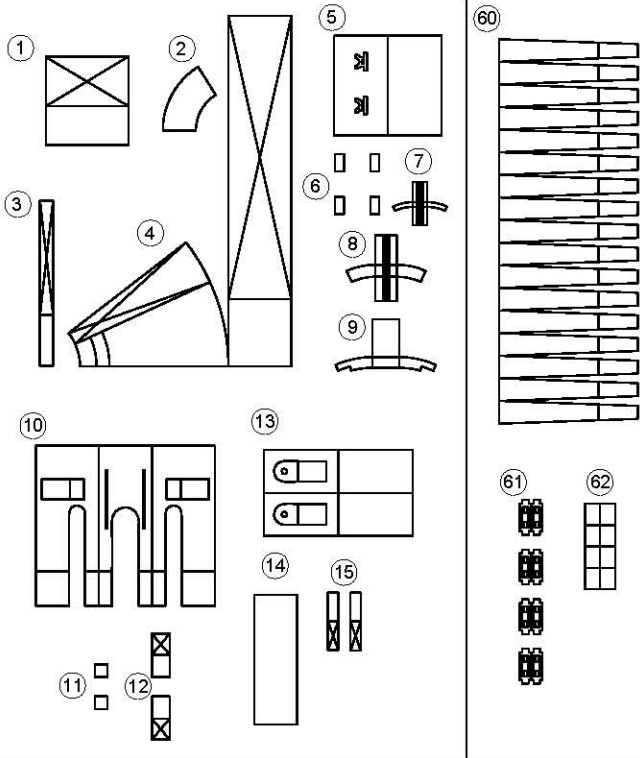

U-Boat Type VIIC 1/72 Scale

0

190 grms

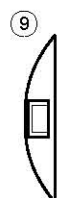
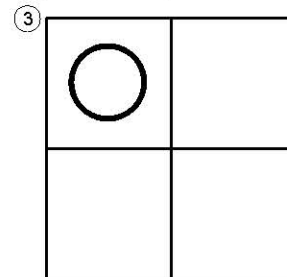
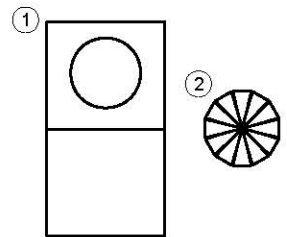
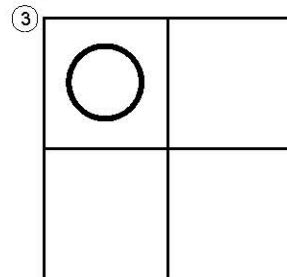
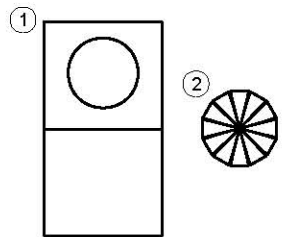
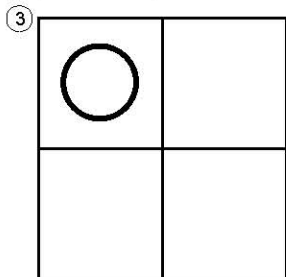
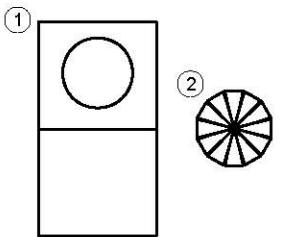
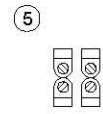
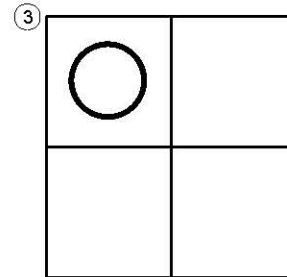
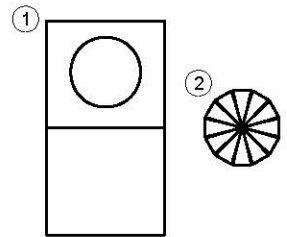
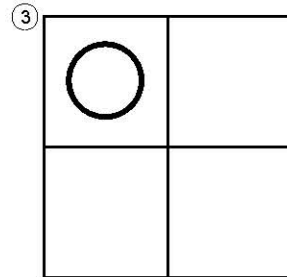
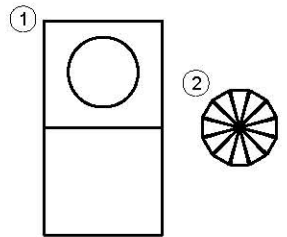
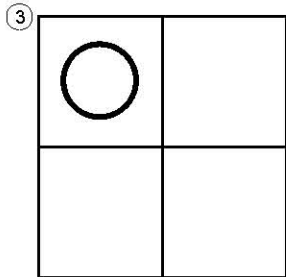
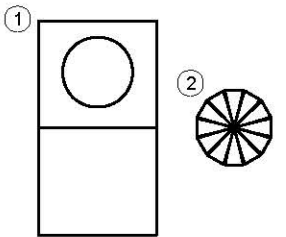
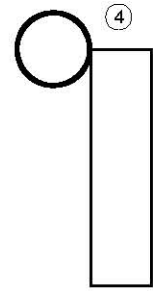
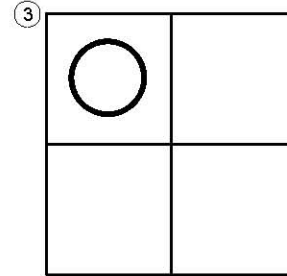
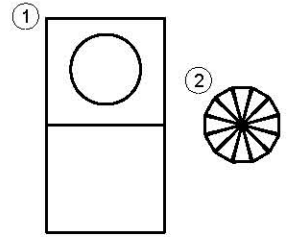
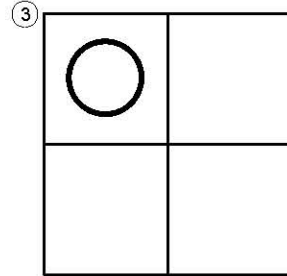
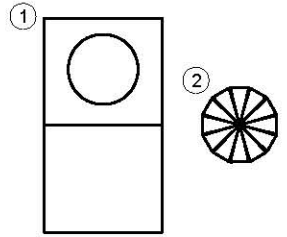
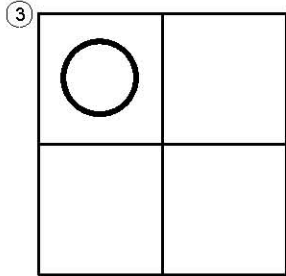
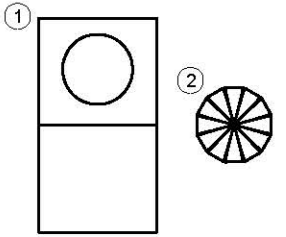

①

②

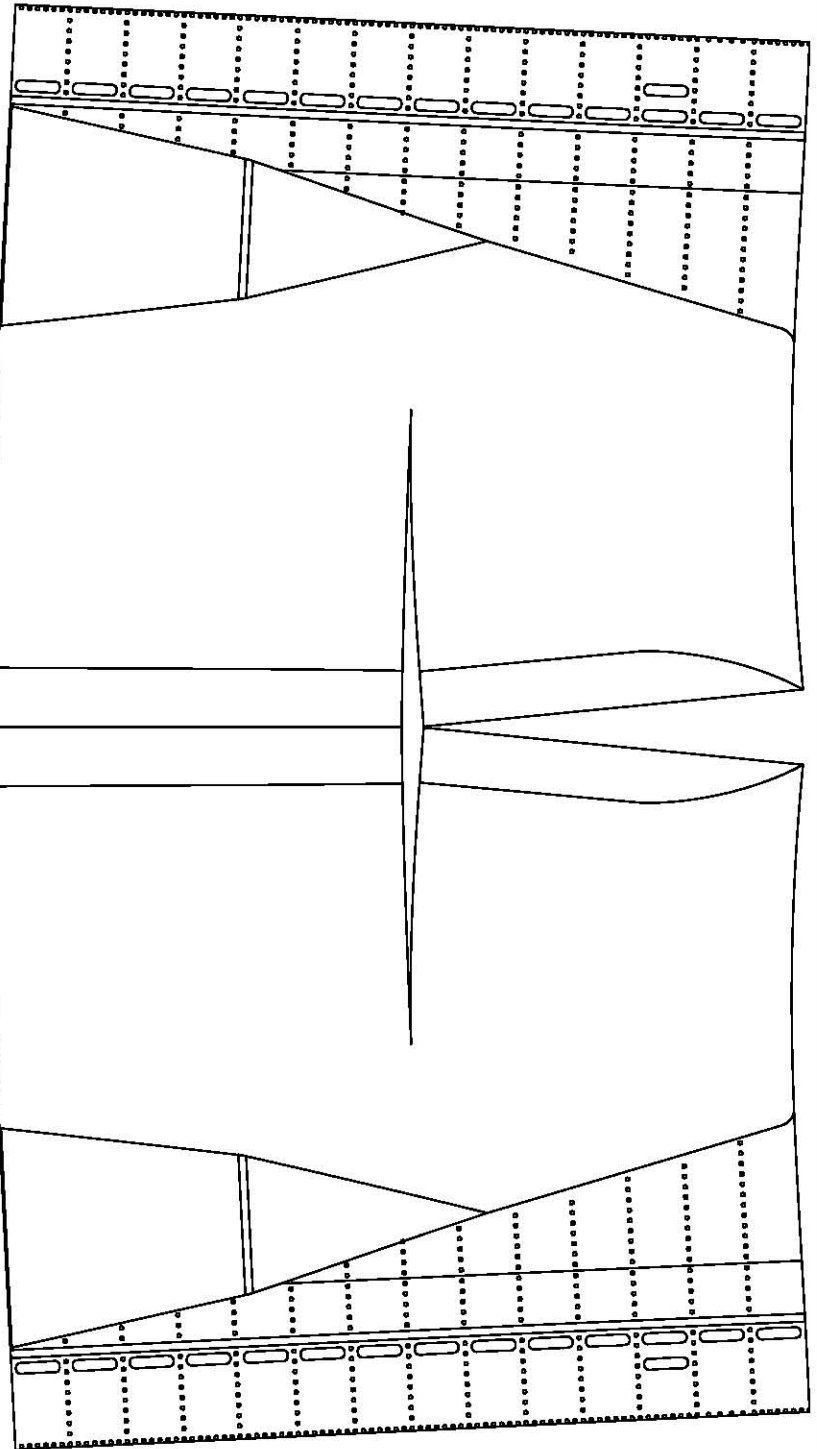
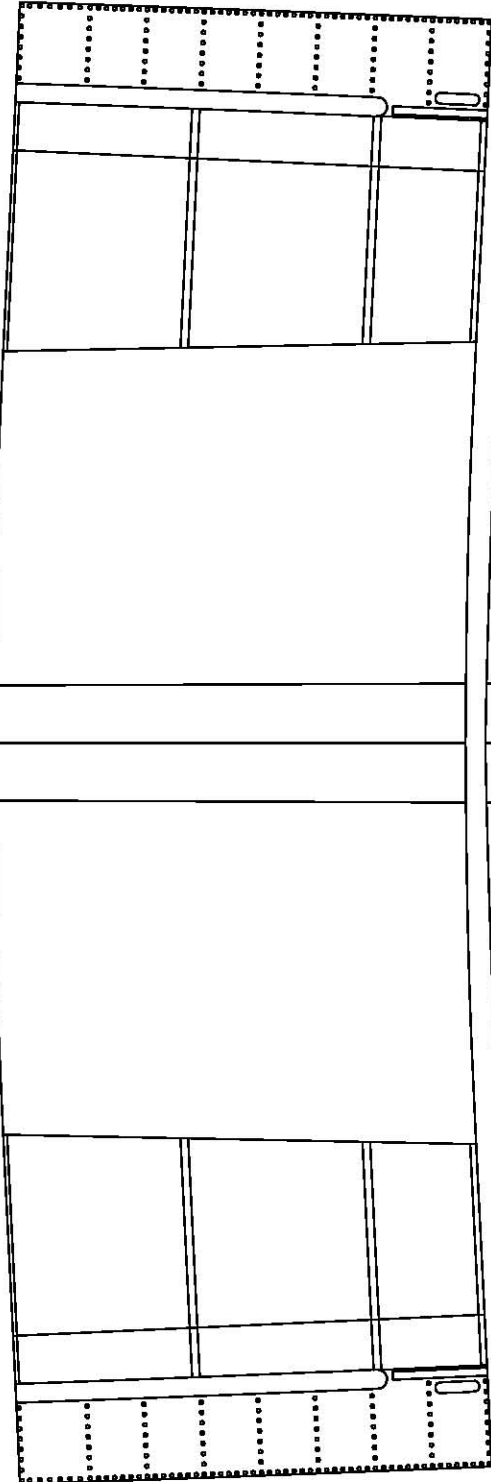

U-Boat Type VIIC 1/72 Scale

Q

190 grms

5L

4L

3L

2L

1L

1R

2R

3R

4R

5R

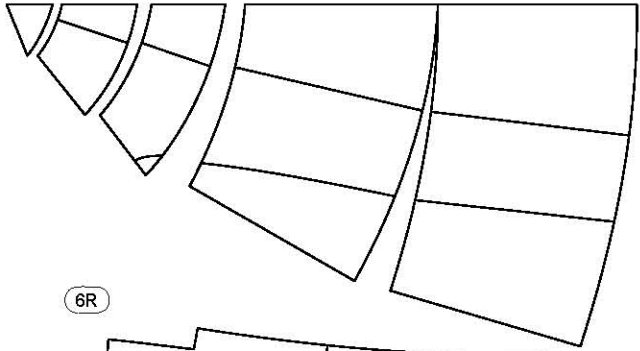
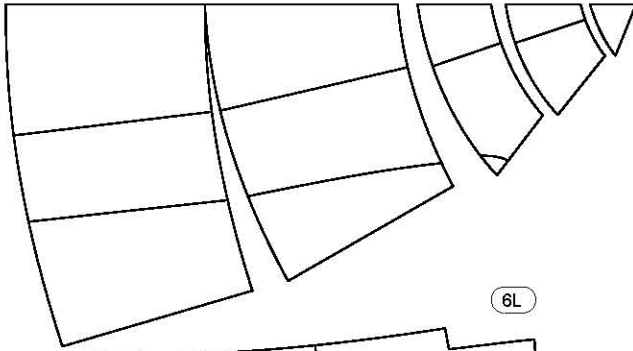

6L

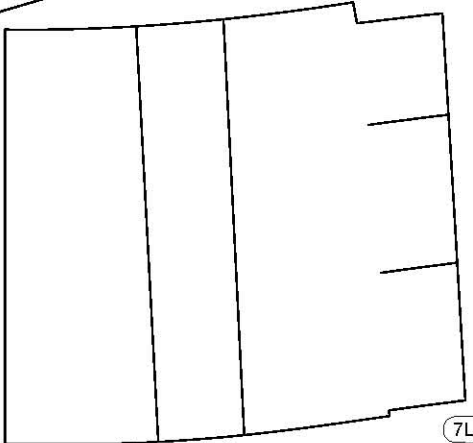

6R

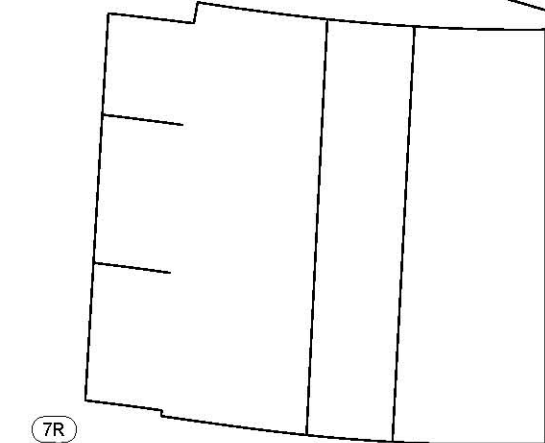

7L

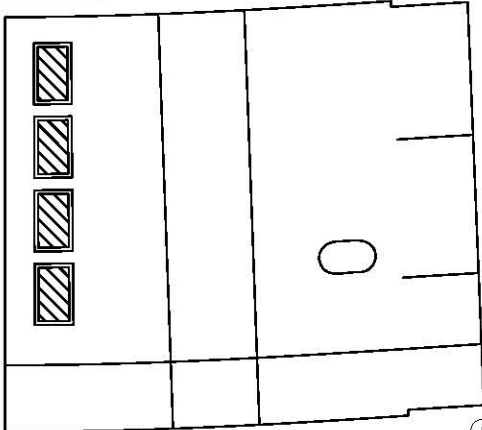

7R

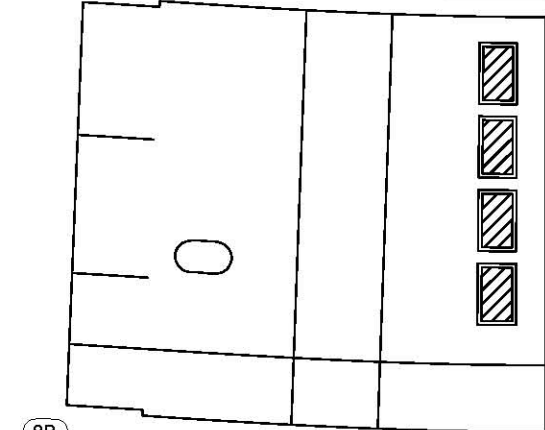

8L

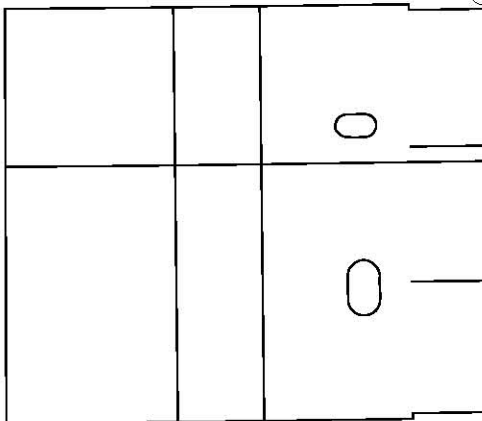

8R

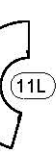
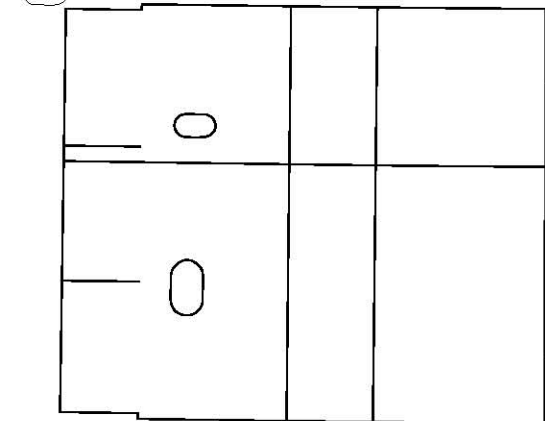

10L



9L



8L

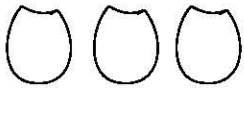

8R



9R



10R

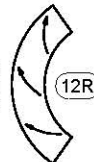
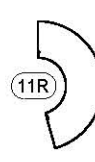

U-Boat Type VIIC 1/72 Scale

R

190 grms

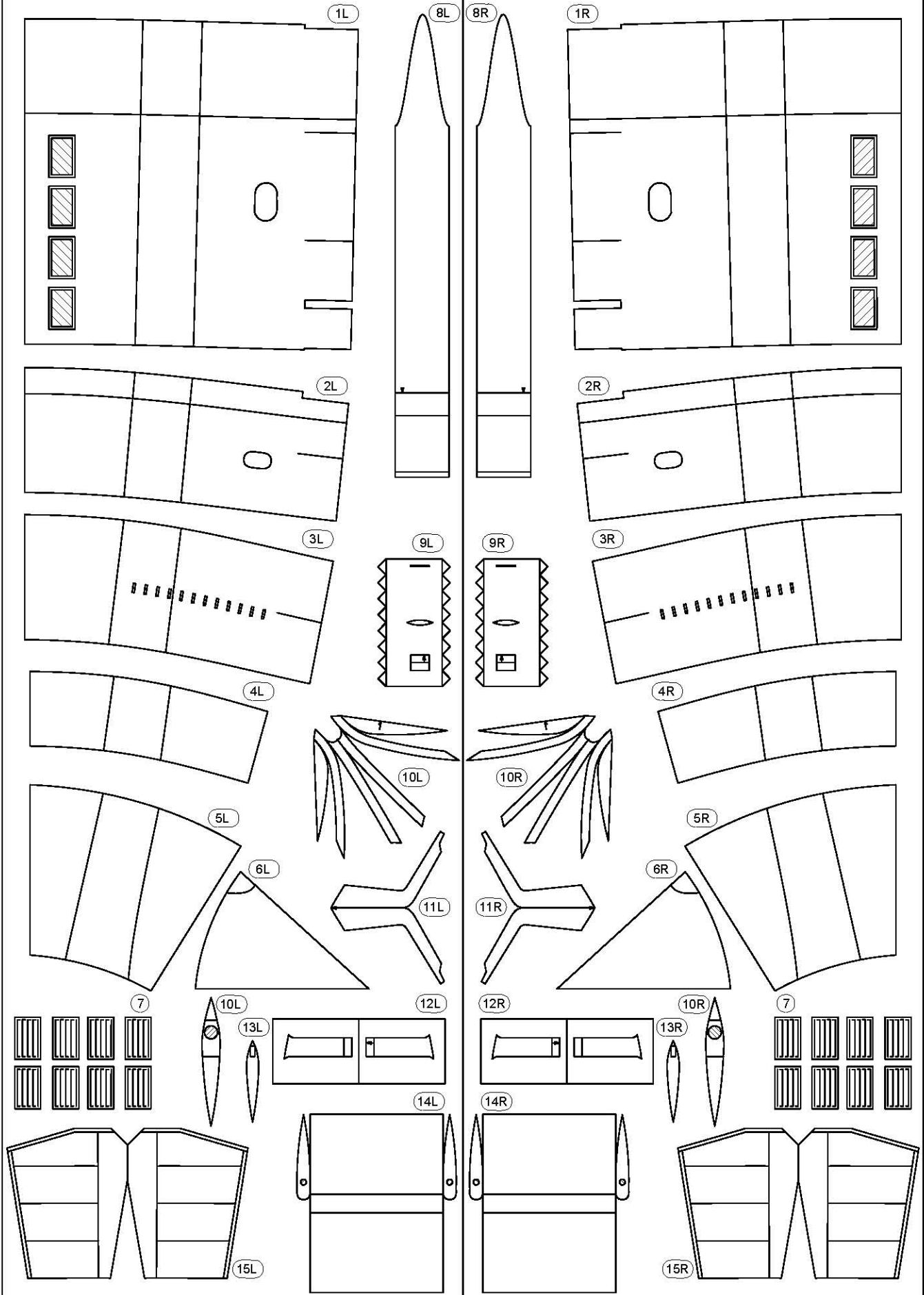

U-Boat Type VIIC 1/72 Scale

S

190 grms

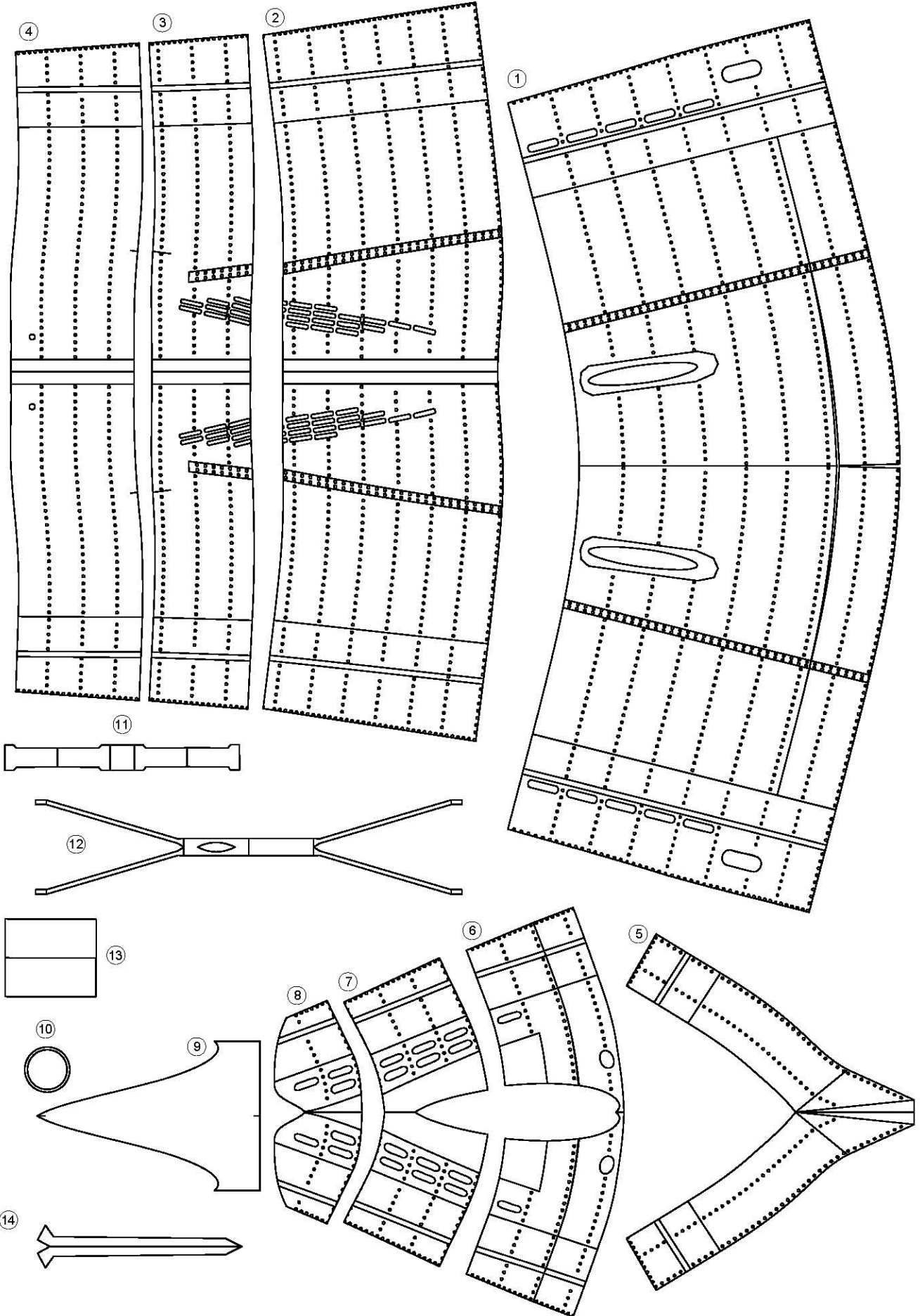

U-Boat Type VIIC 1/72 Scale

ST-1

70 grms

A-3a A-4a A-5a A-6a

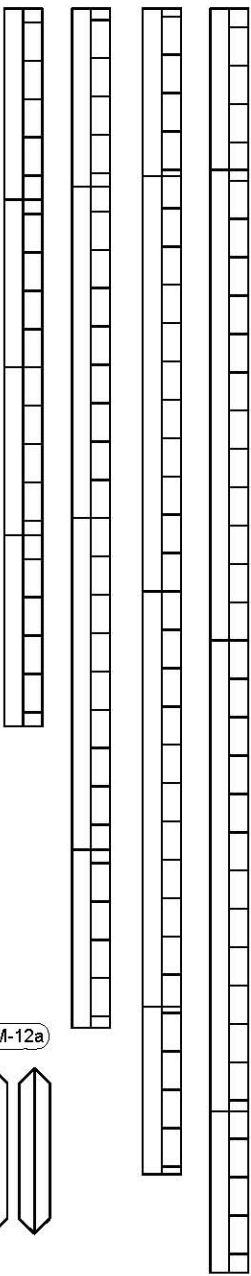

M-12a

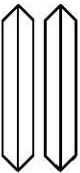

A-8a

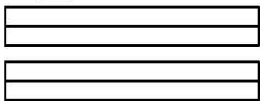

A-8bL

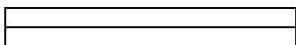

A-8bR



A-8c

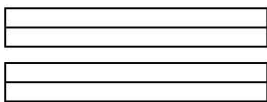

C-1a C-2a C-3a C-4a C-5a

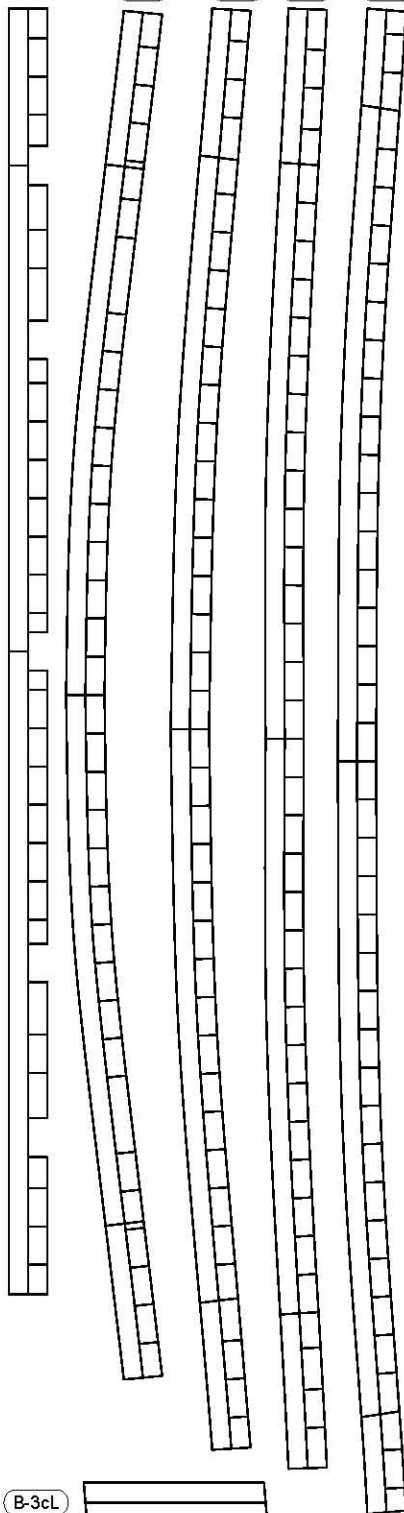

B-3cL

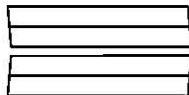

B-3cR



B-3b

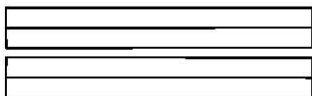

B-3dL

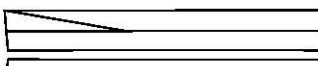

B-3dR

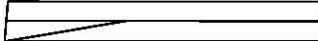

C-6a C-7a D-2a D-3a D-4a E-2a

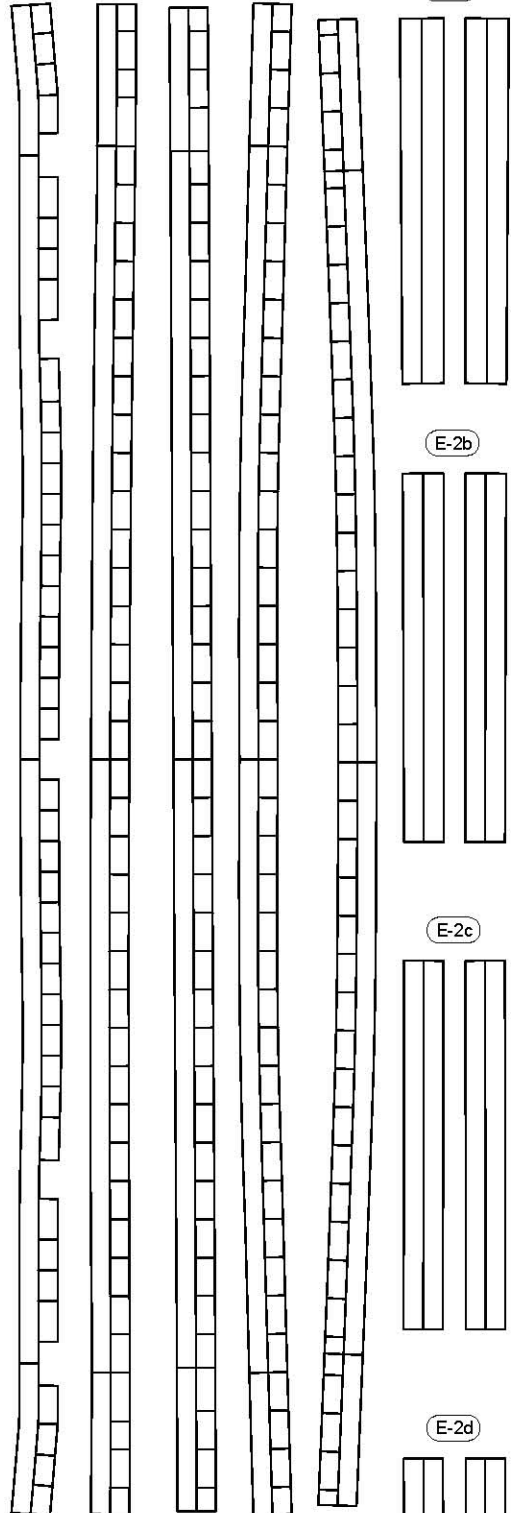

E-2b

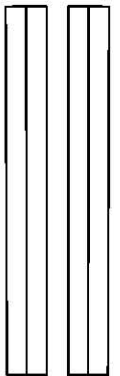

E-2c

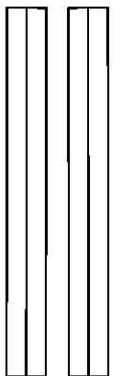

E-2d

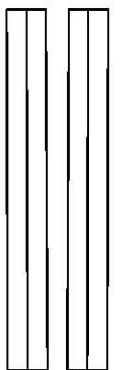

B-3a

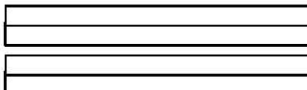

U-Boat Type VIIC 1/72 Scale

ST-2

70 grms

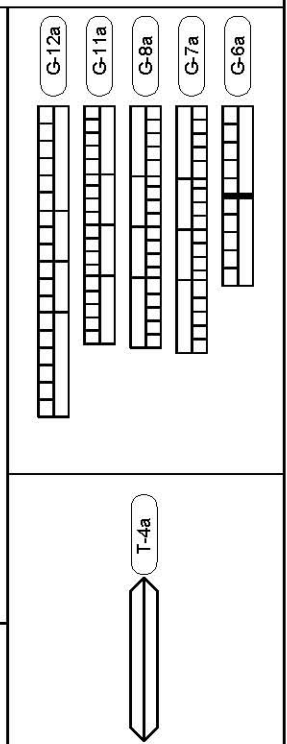
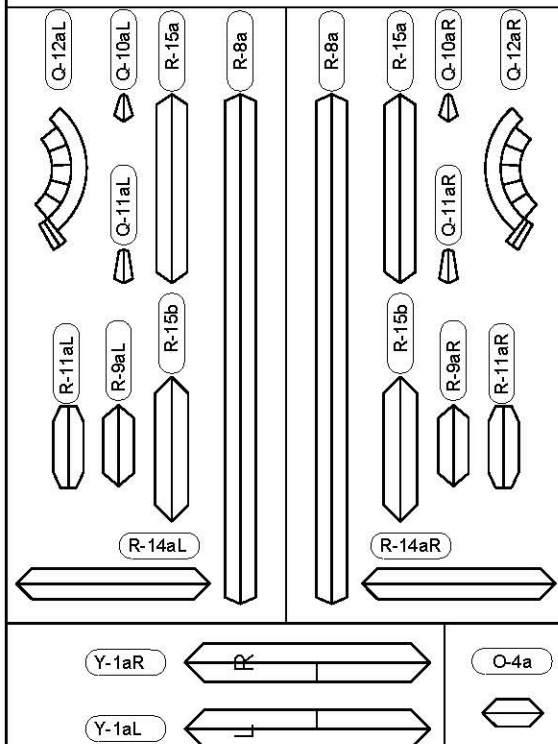
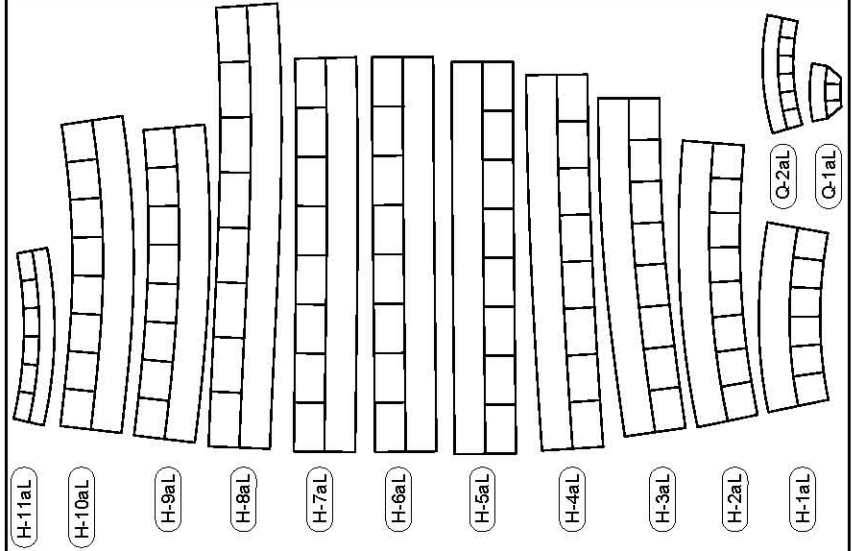
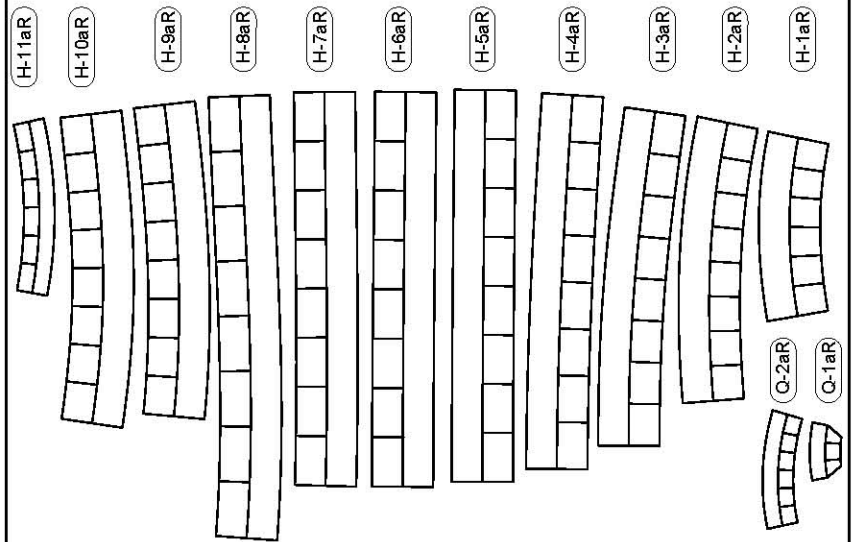
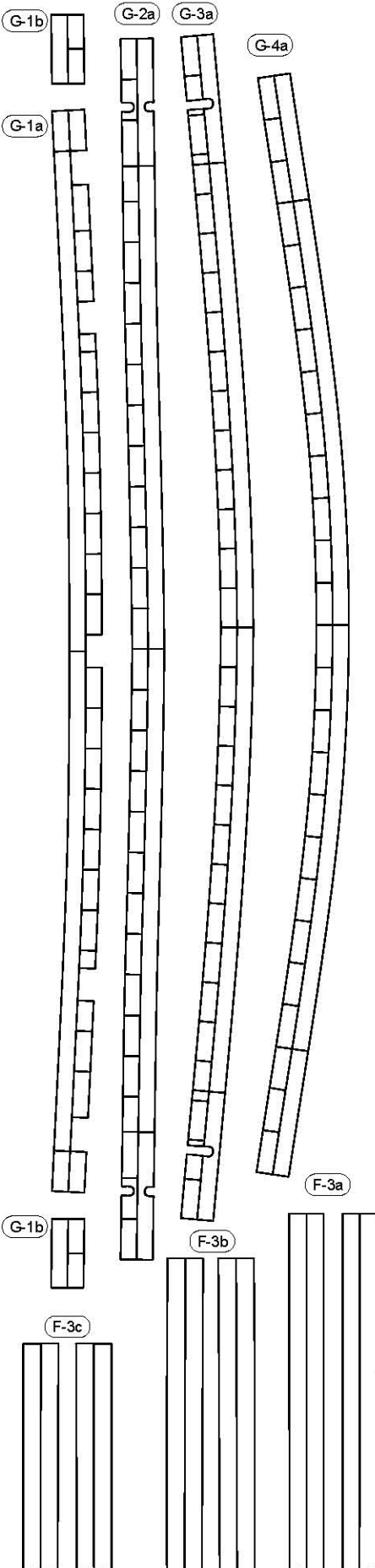

U-Boat Type VIIC 1/72 Scale

ST-3

70 grms

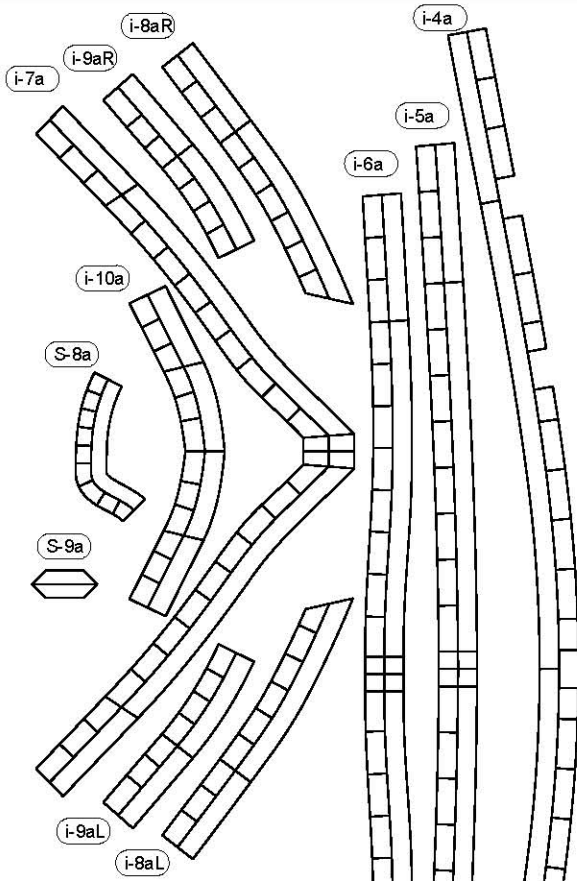

Y-4a

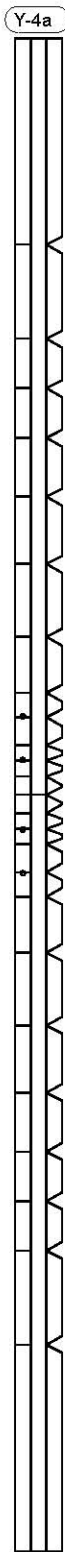

V-2a

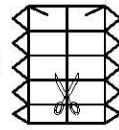

V-2b

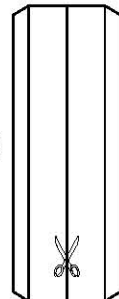

V-3a

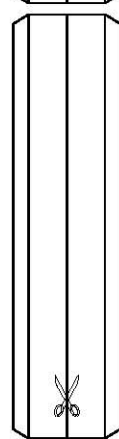

V-3b

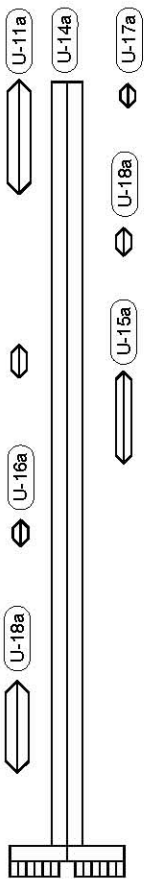
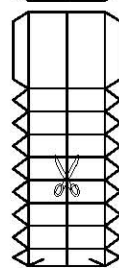

U-24a

U-24b

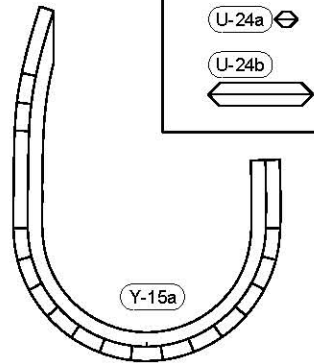

U-28a U-31a U-32a

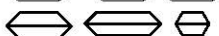

U-34a

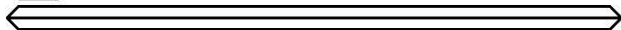

Y-27a



U-Boat Type VIIC 1/72 Scale

T

190 grms

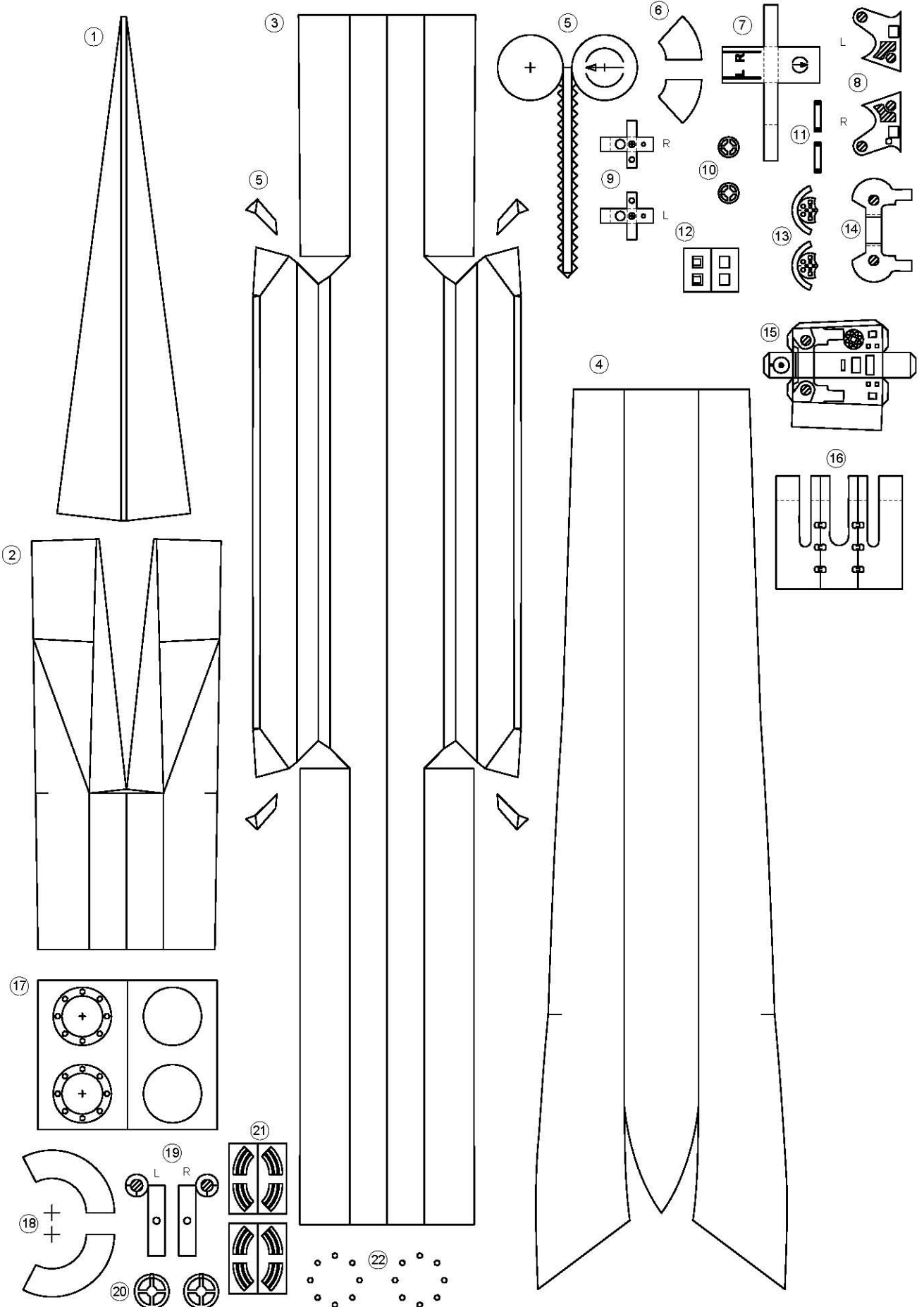

U-Boat Type VIIC 1/72 Scale

U

190 grms

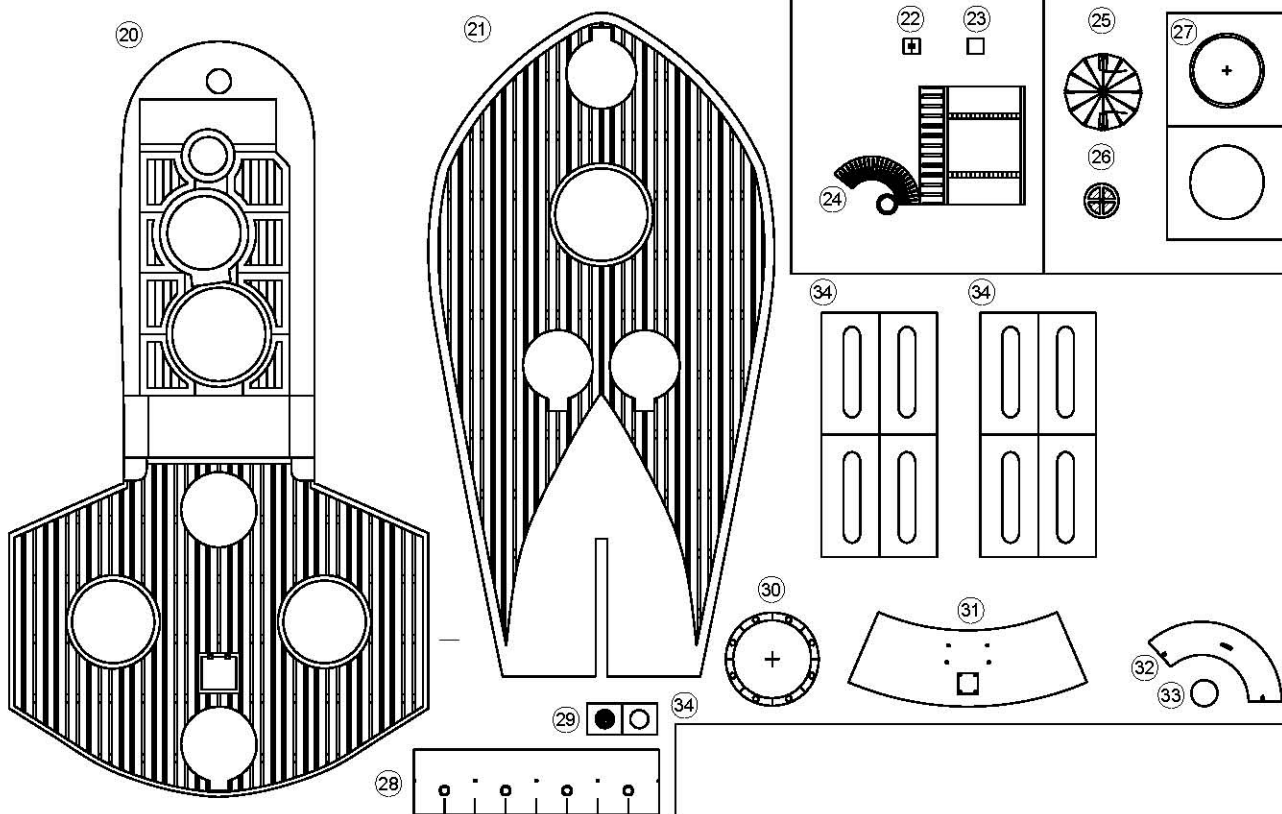
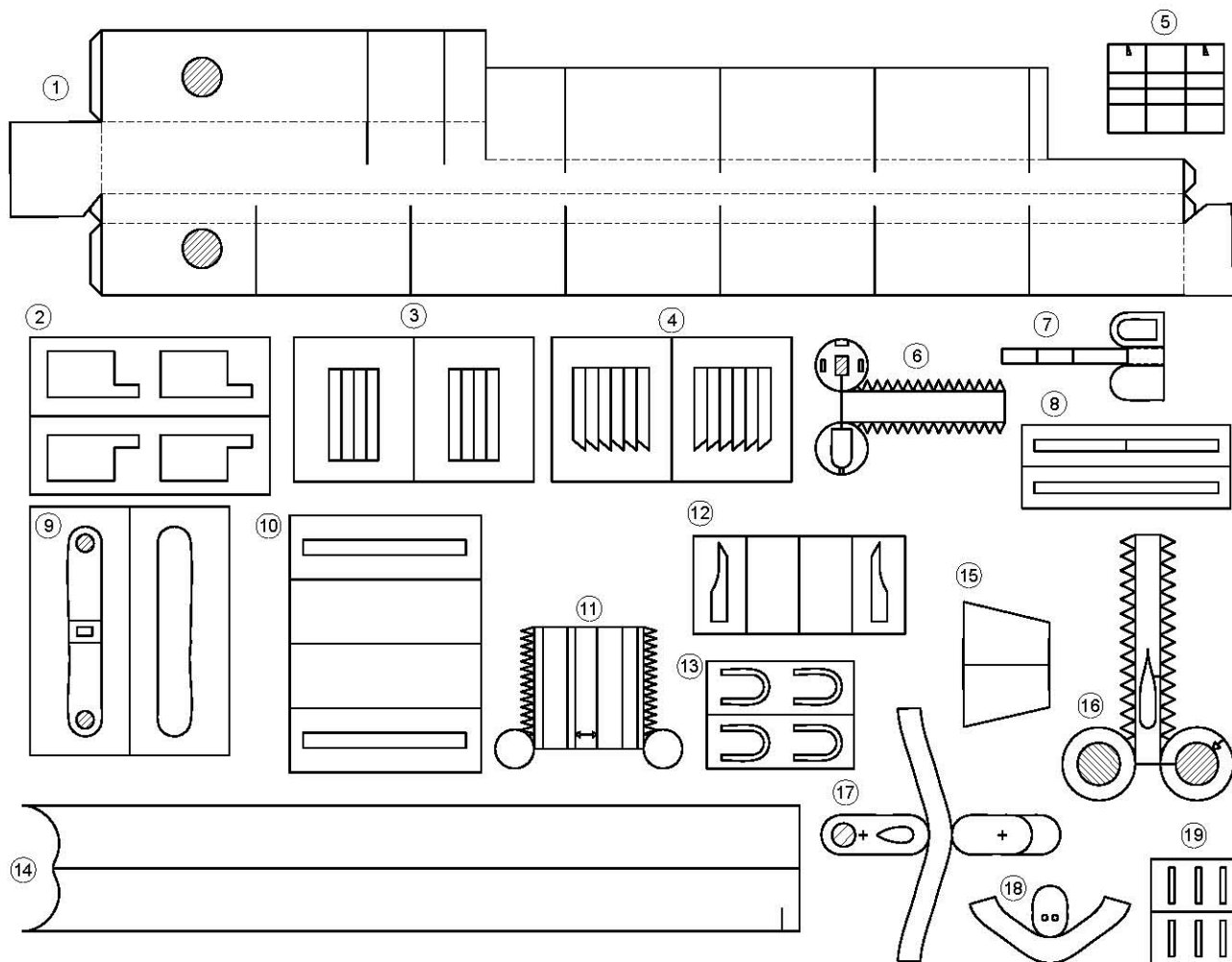

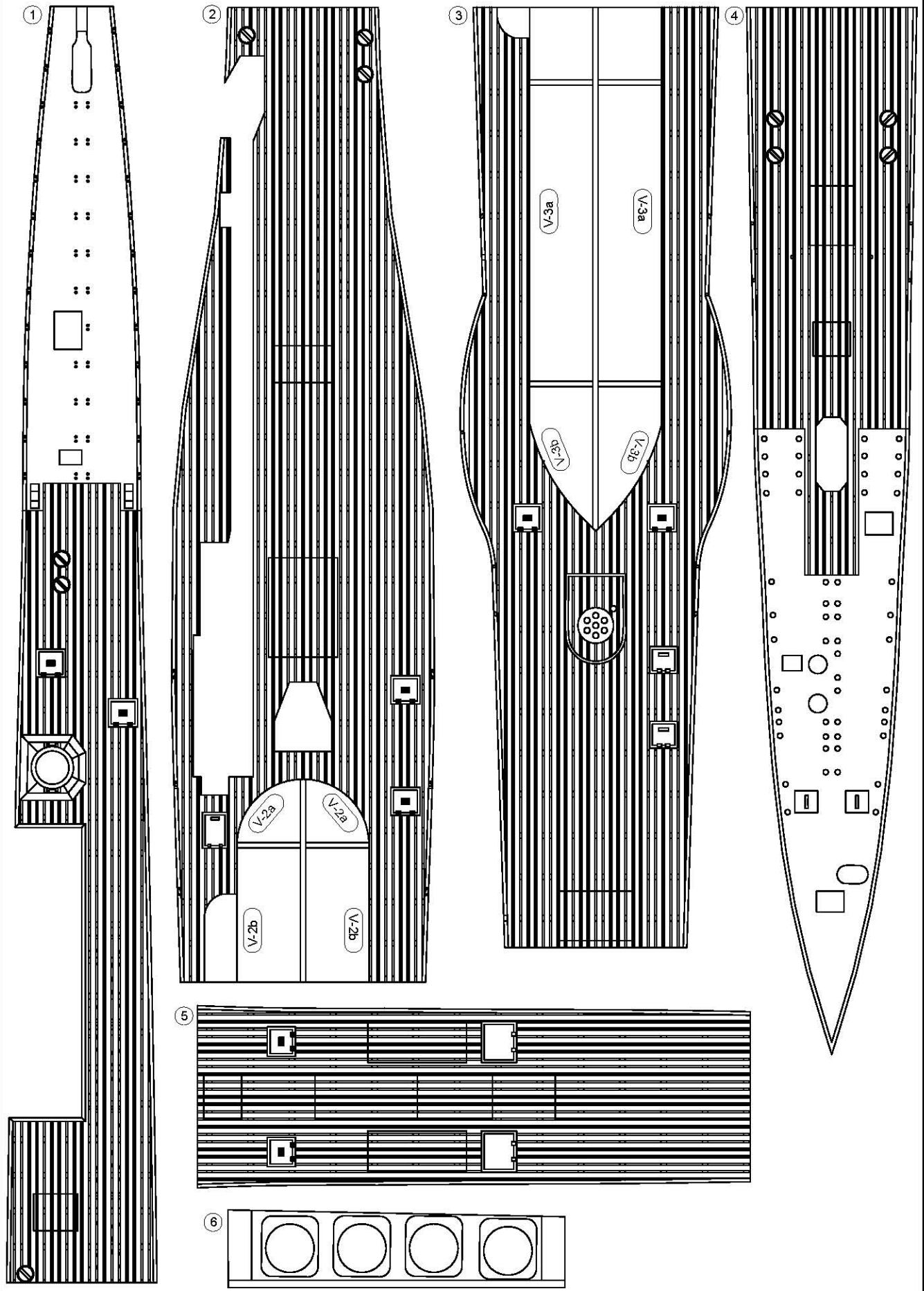

U-Boat Type VIIC 1/72 Scale

W 70 grms

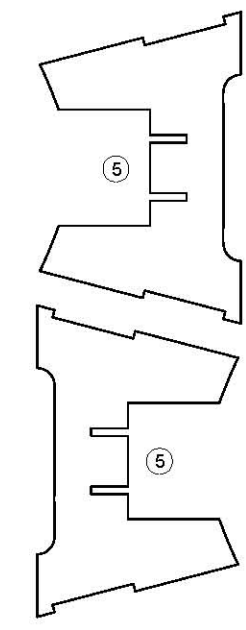
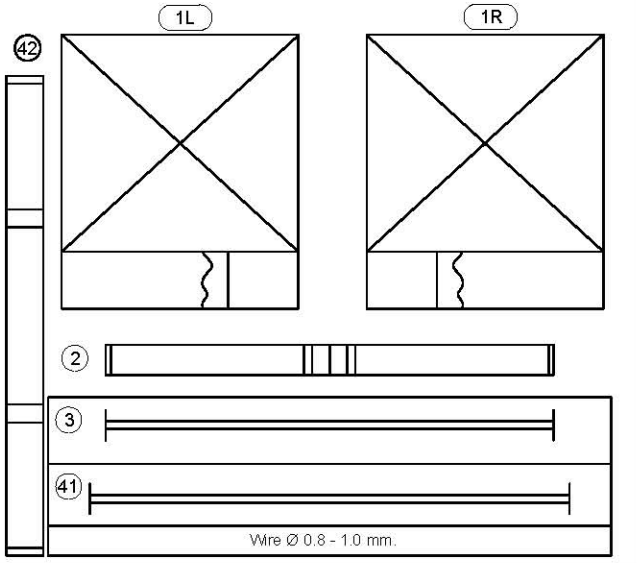

Part No. 4,5,6 and 7 need to be laminated to 1mm card board.

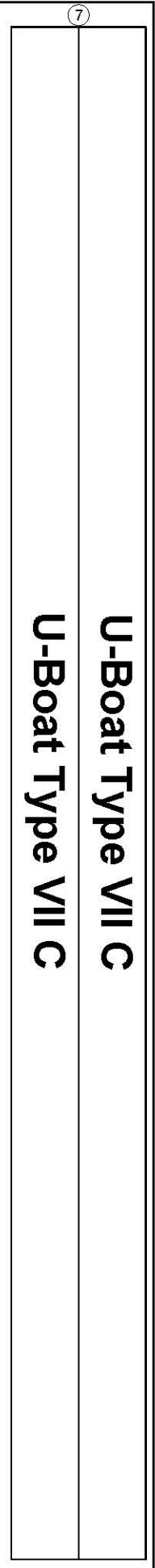
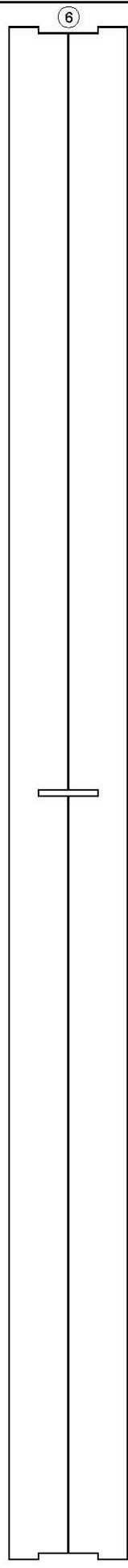
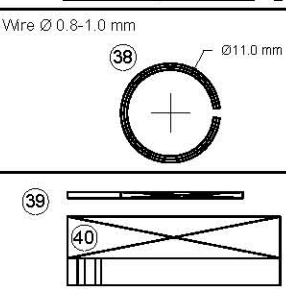
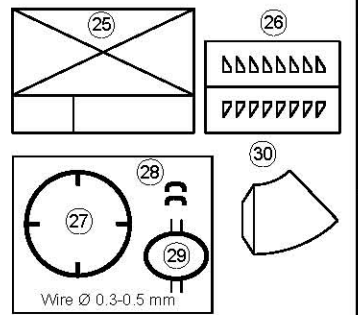
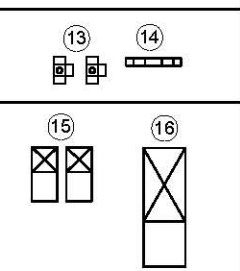
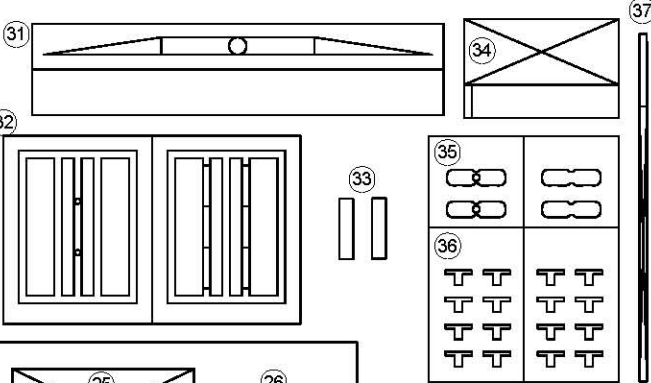
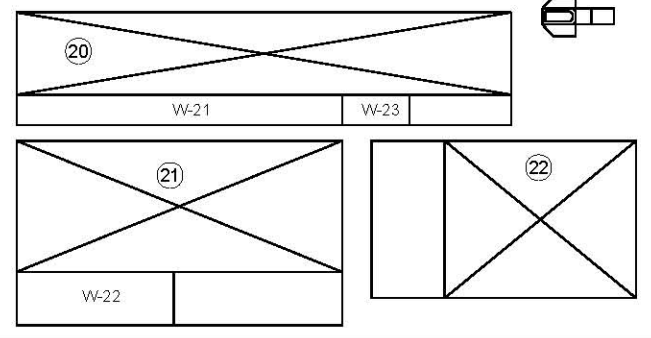
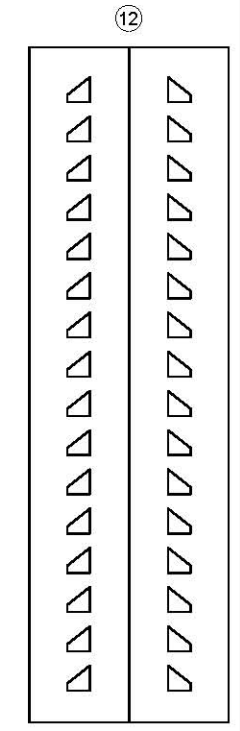
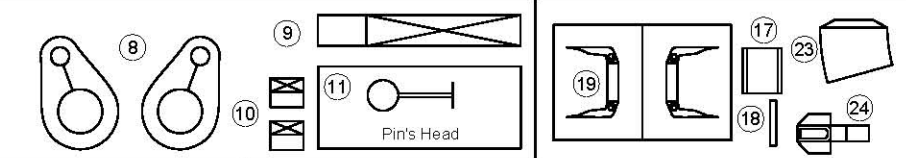
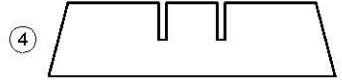

U-Boat Type VIIC

U-Boat Type VIIC 1/72 Scale

X

70 grms + 1 mm CardBoard

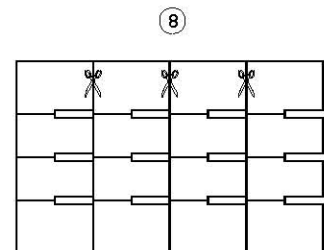
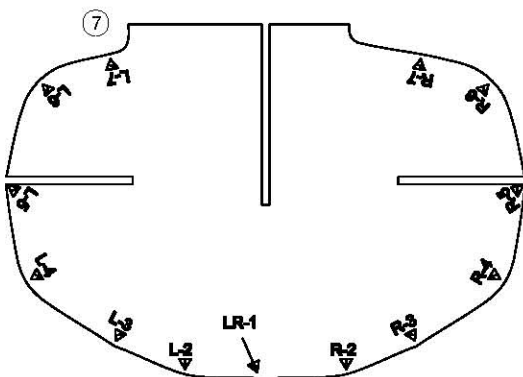
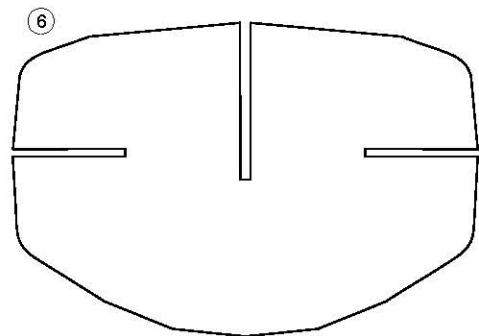
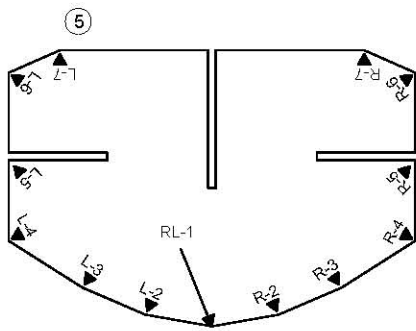
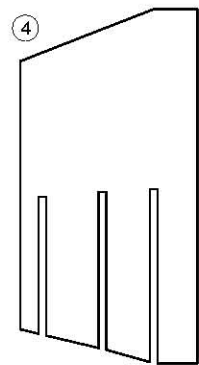
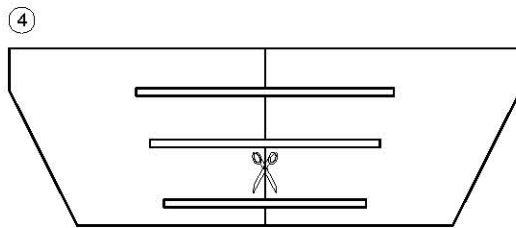
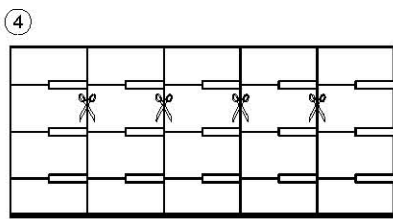
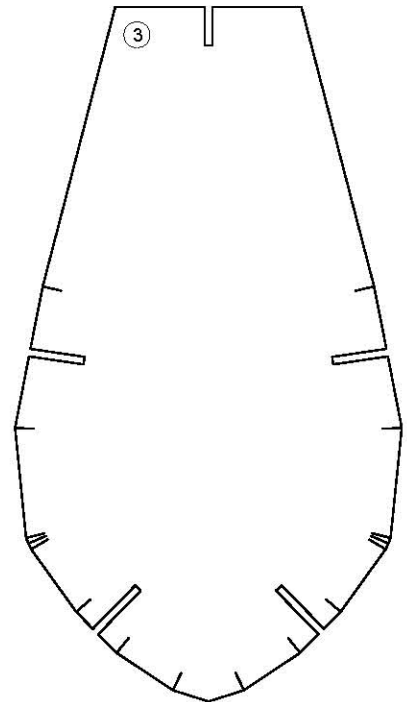
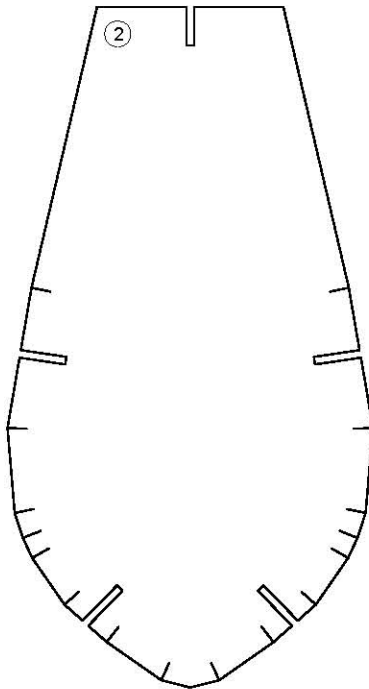
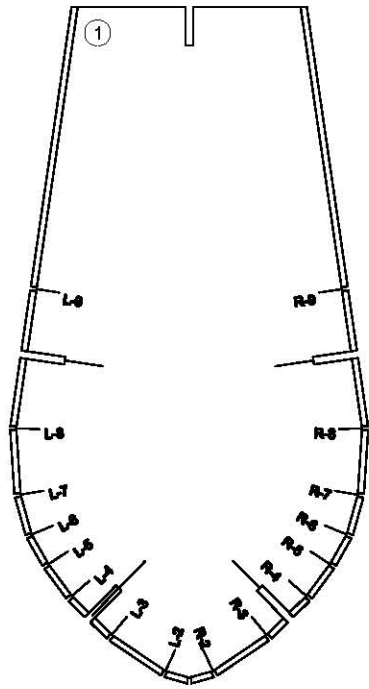

U-Boat Type VIIC 1/72 Scale

Y

190 grms

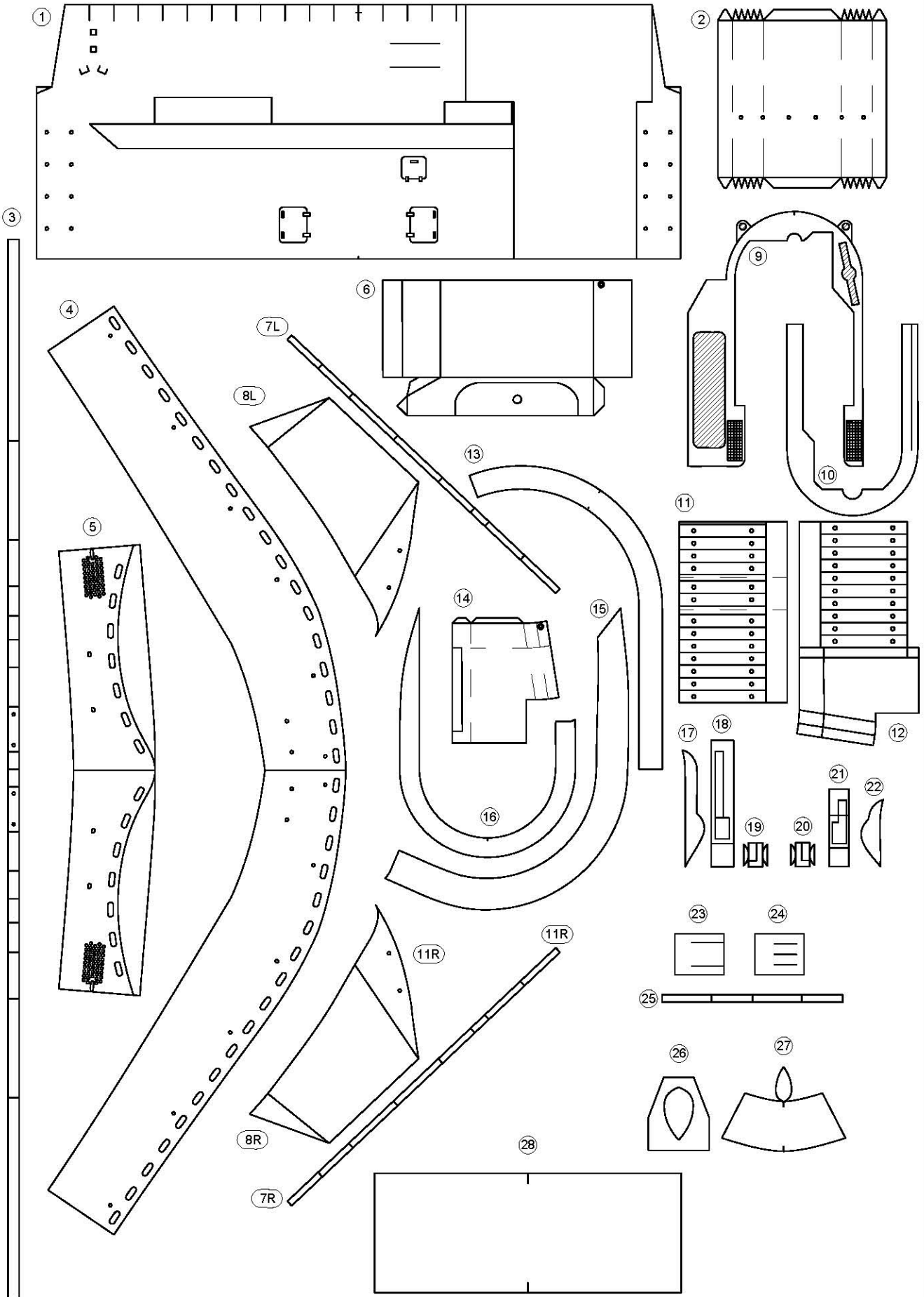

U-Boat Type VIIC 1/72 Scale

Z

70 grms

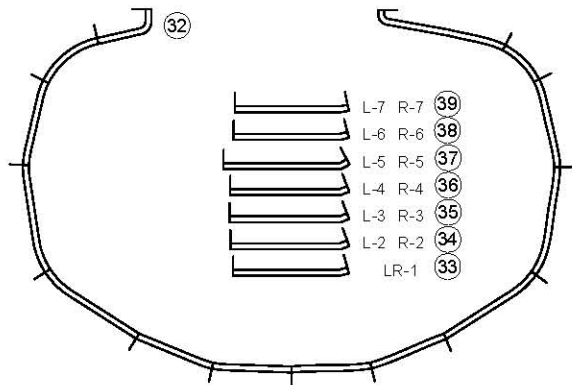
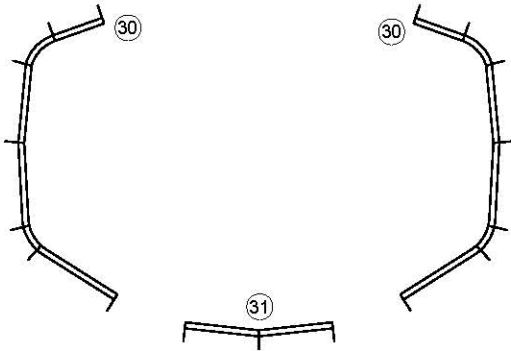
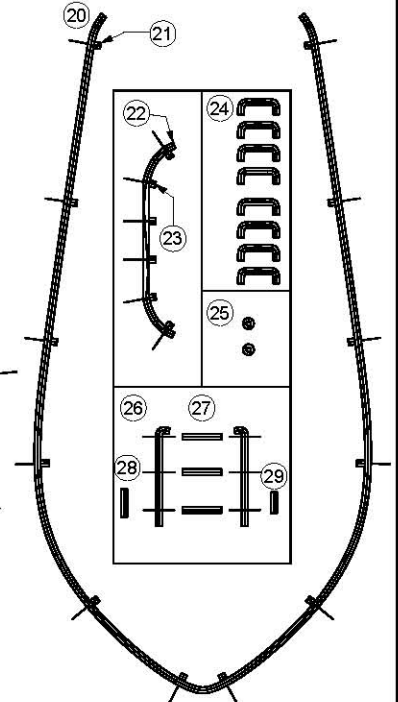
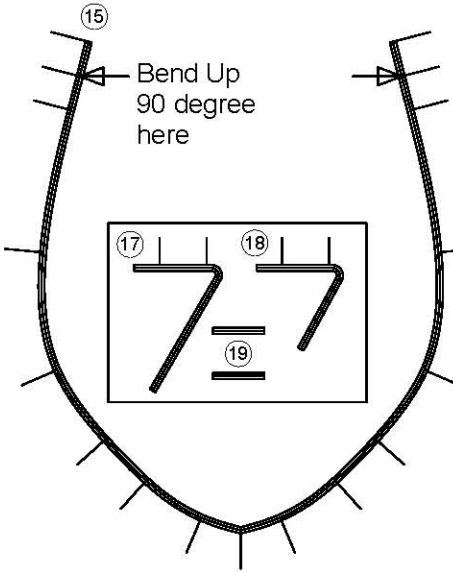
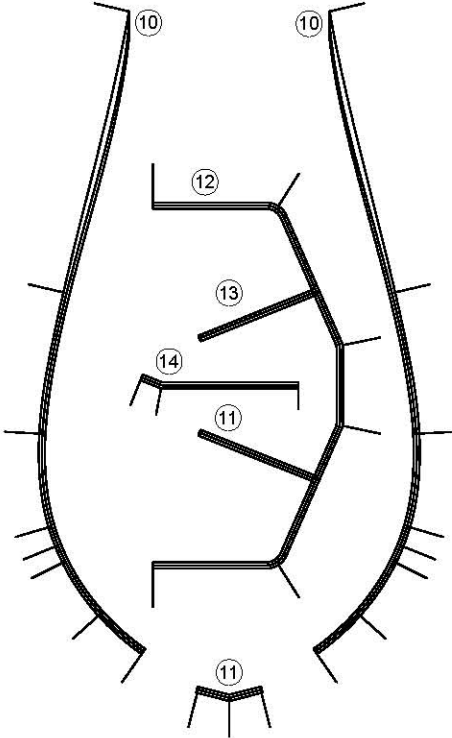
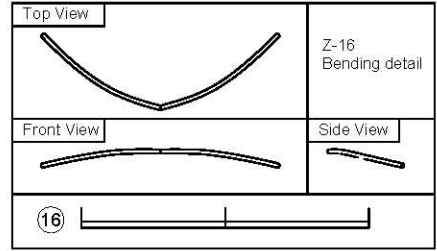
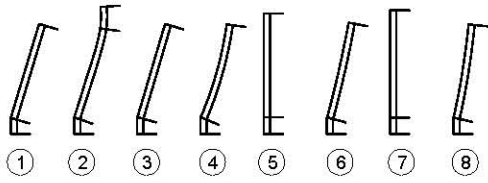

Wire Ø 0.8 - 1.0 mm.



Wire Ø 0.8 - 1.0 mm.



Wire Ø 0.8 - 1.0 mm.



Wire Ø 0.3 - 0.5 mm.

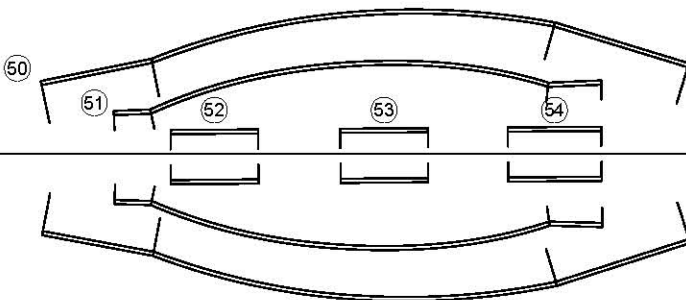

Wire Ø 0.8 - 1.0 mm.

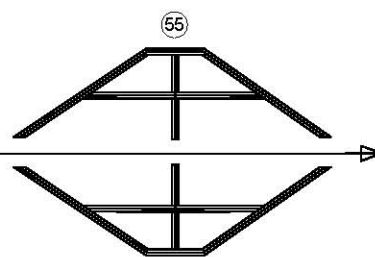

How to make Z-44 and Z-45

