

# U-Boat Type VIIC 1/72 Scale

A

70 grms + 1 mm CardBoard

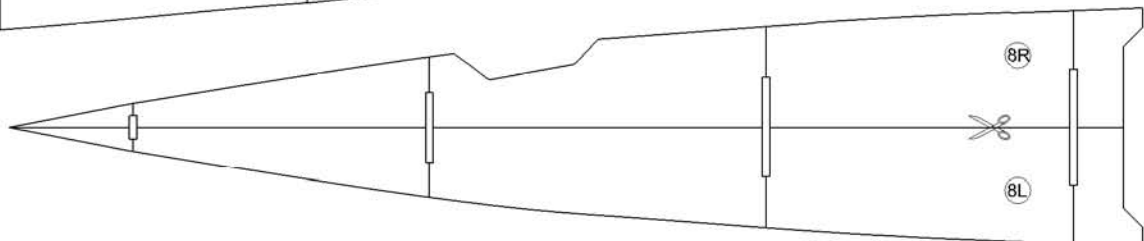
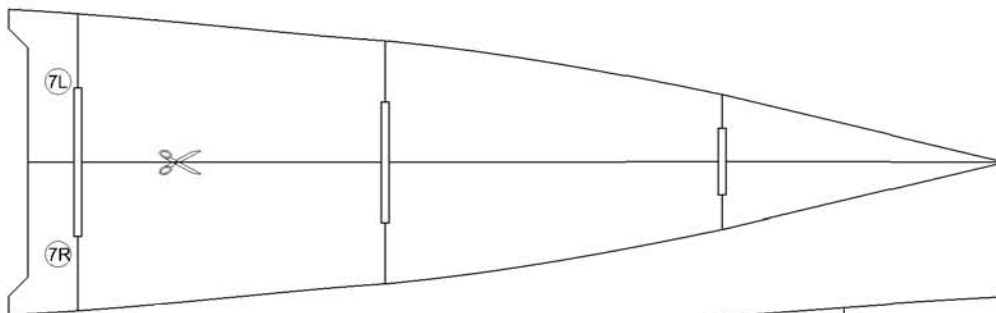
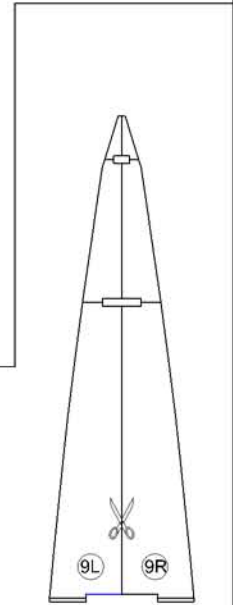
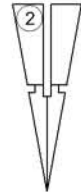
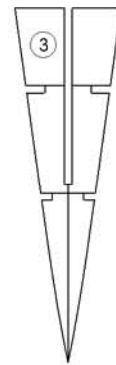
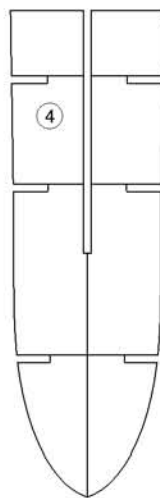
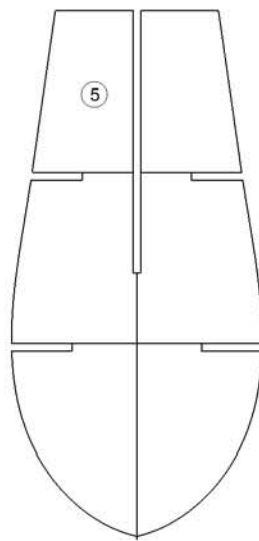
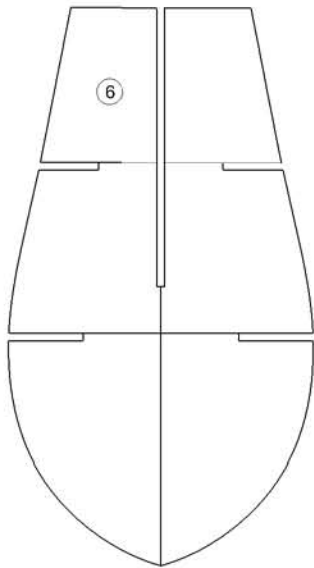
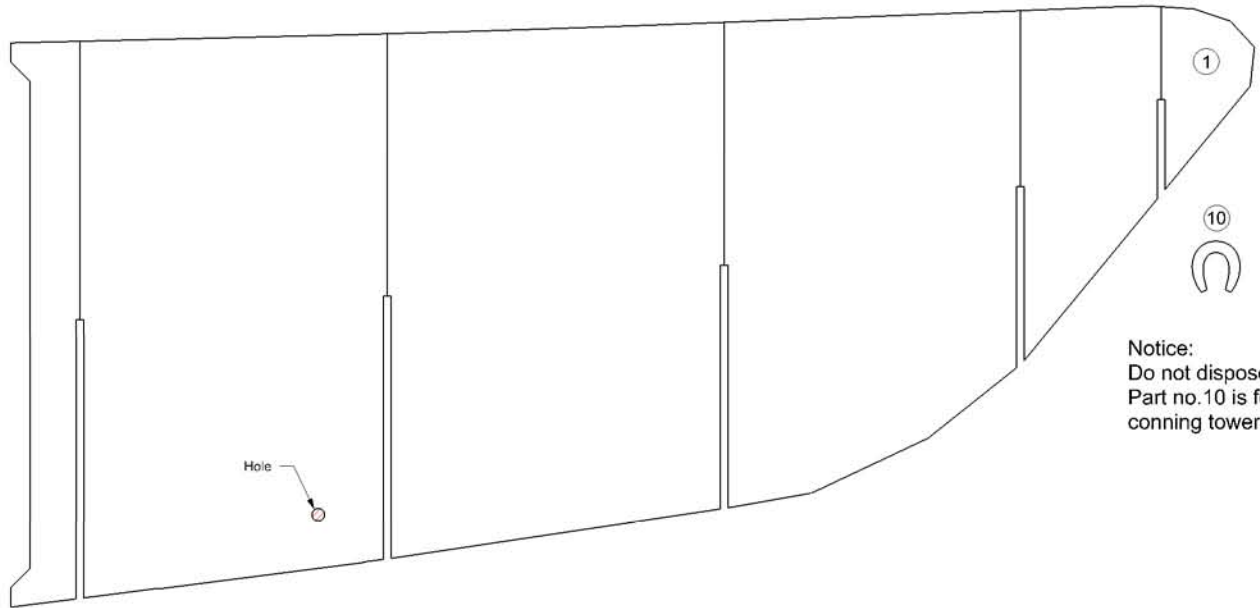

U-Boat Type VIIC 1/72 Scale

B

70 grms + 1 mm CardBoard

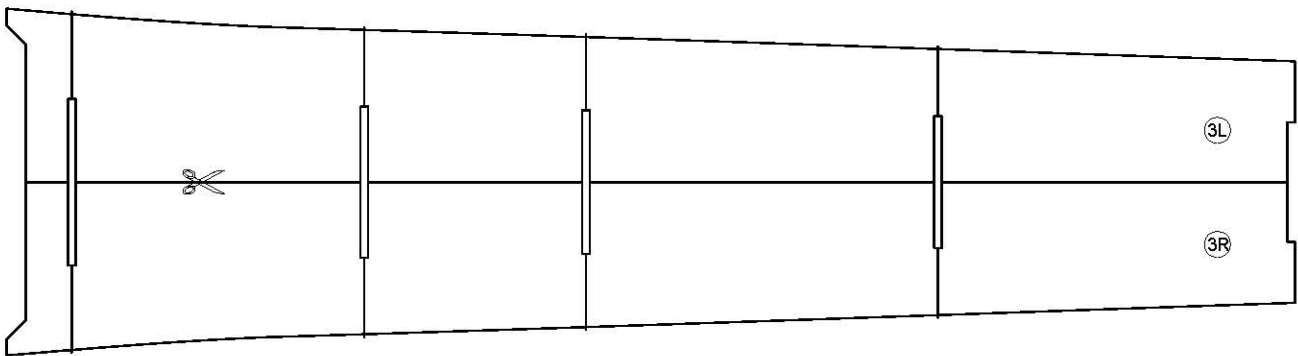
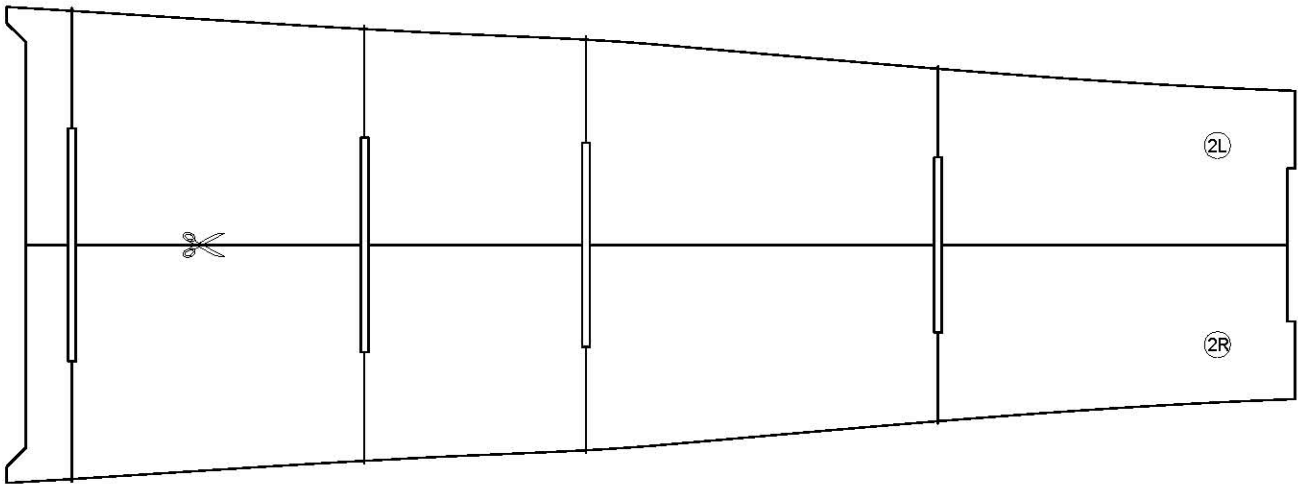
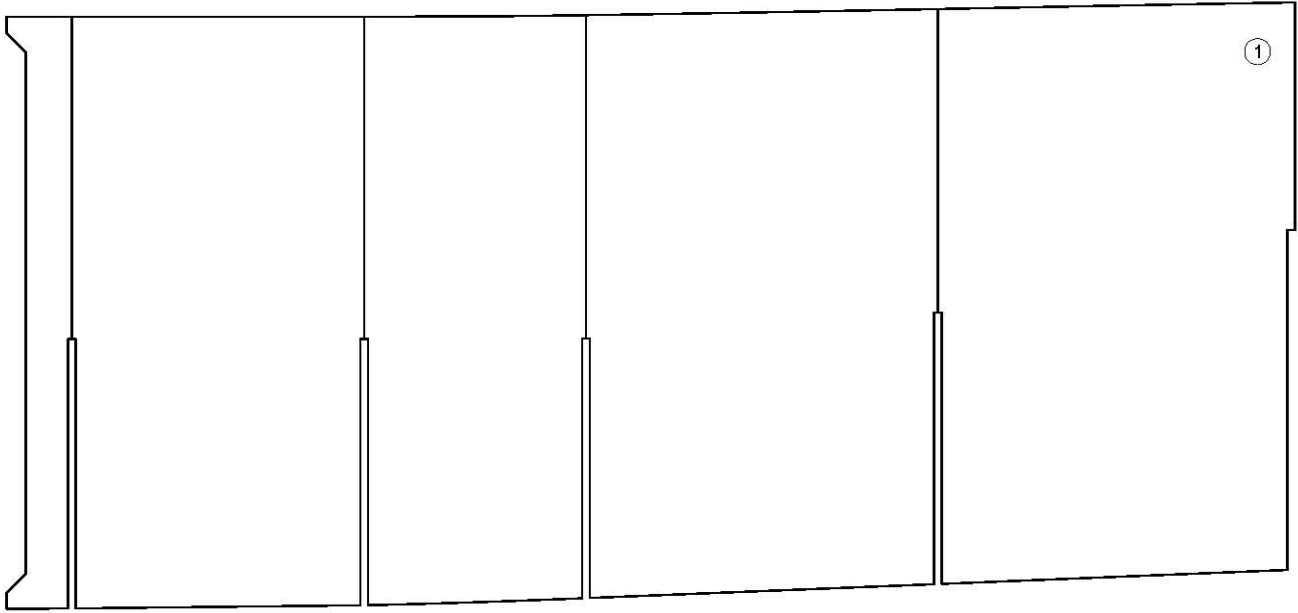

# U-Boat Type VIIC 1/72 Scale

C

70 grms + 1 mm CardBoard

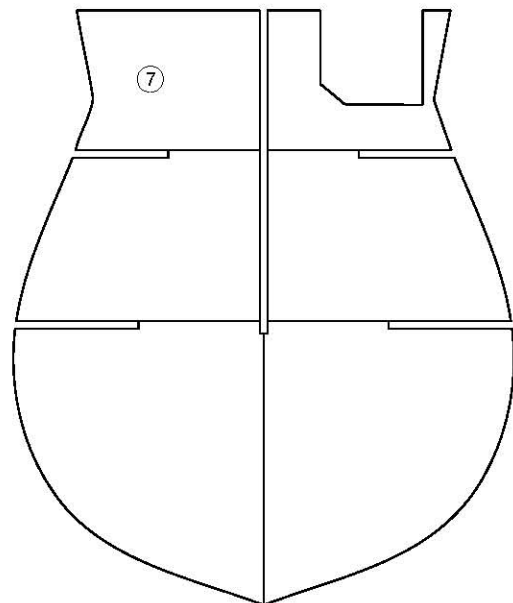
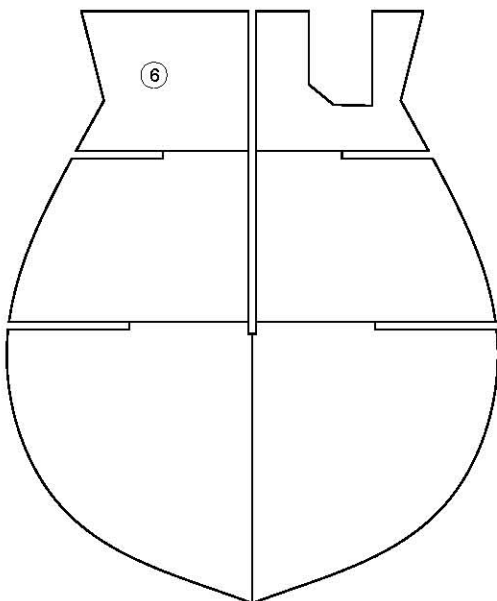
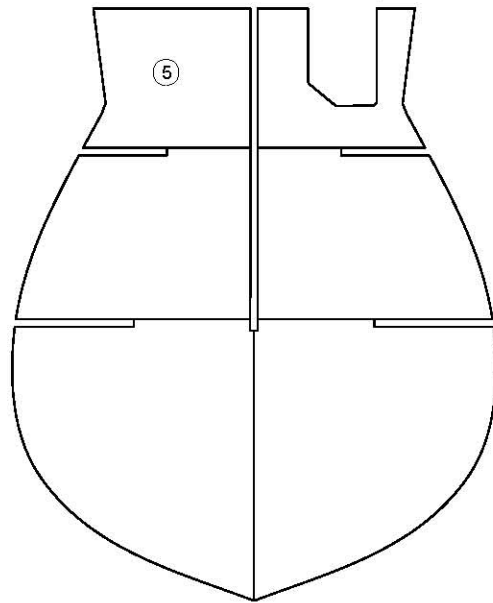
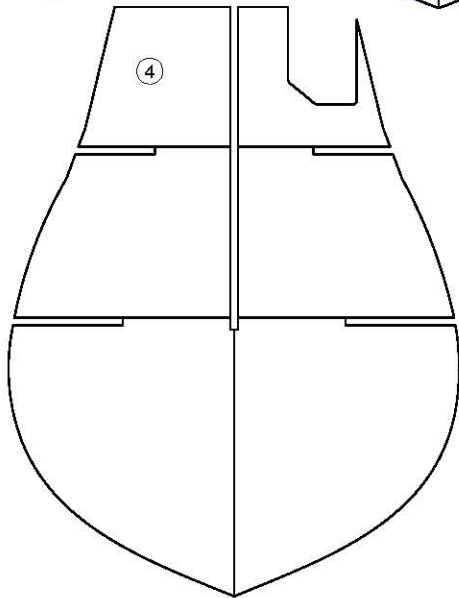
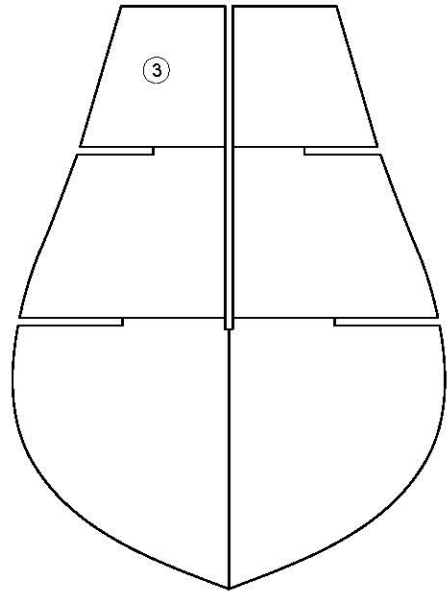
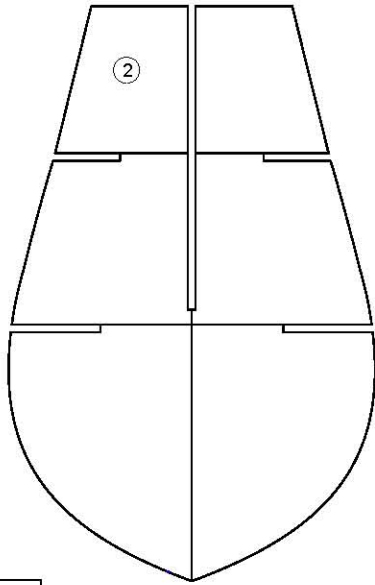
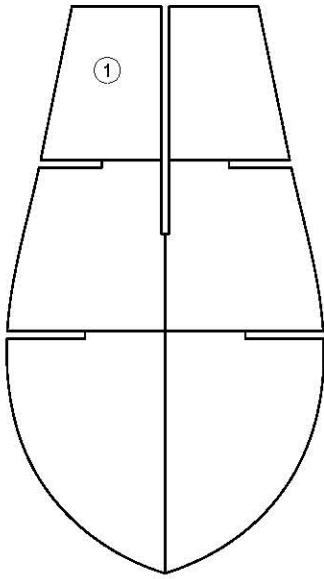

# U-Boat Type VIIC 1/72 Scale

D

90 grms + 1 mm CardBoard

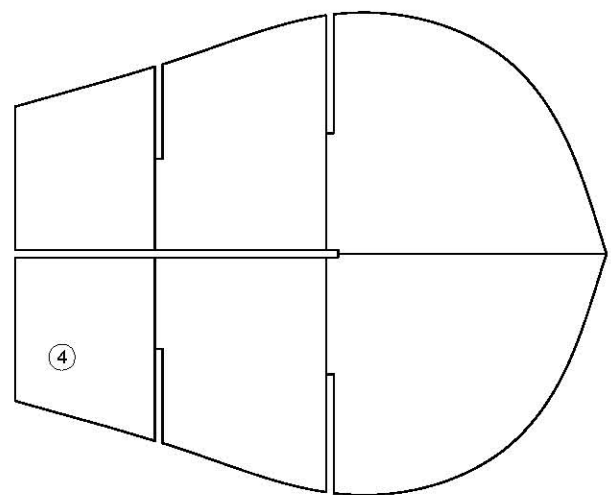
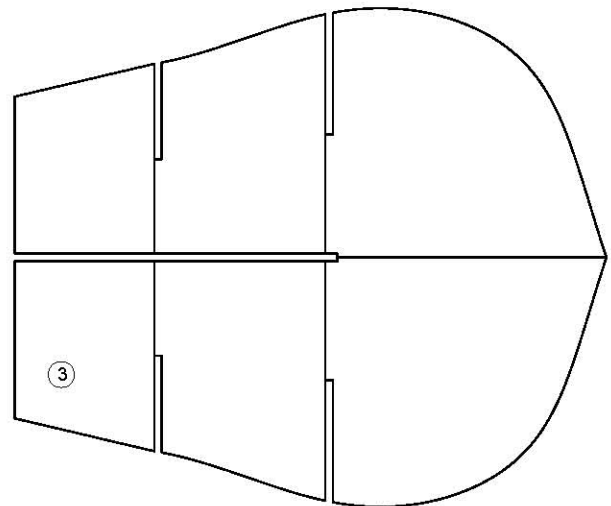
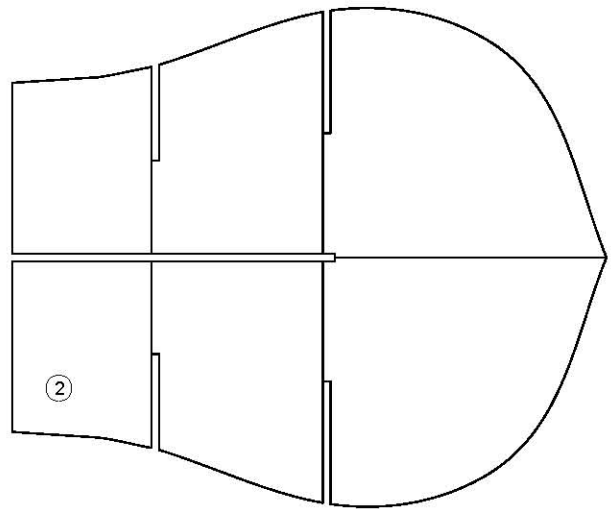
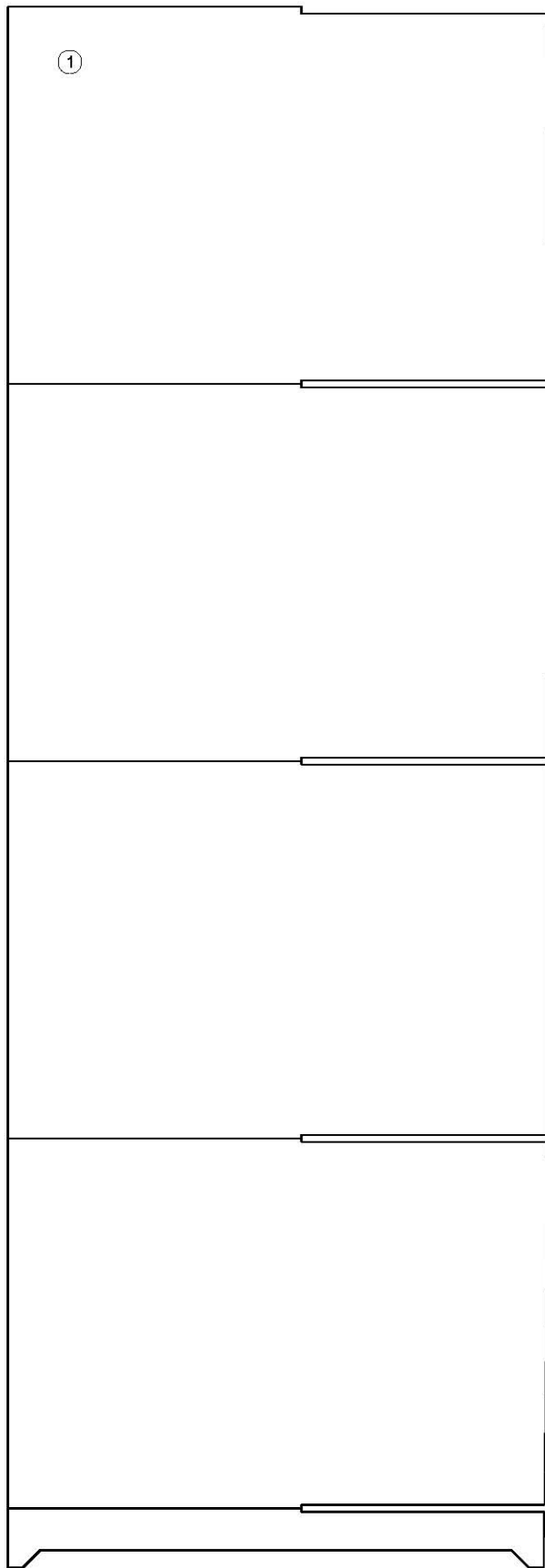

# U-Boat Type VIIC 1/72 Scale

E

70 grms + 1 mm CardBoard

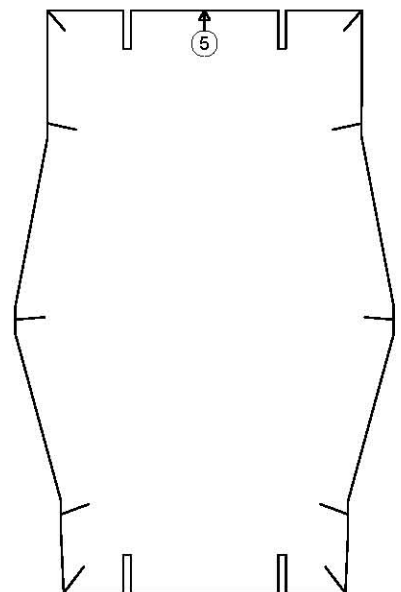
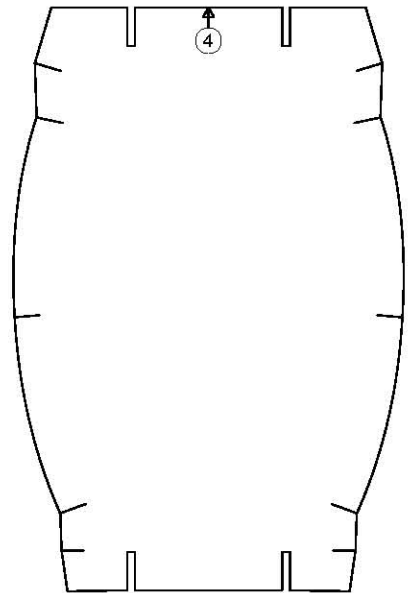
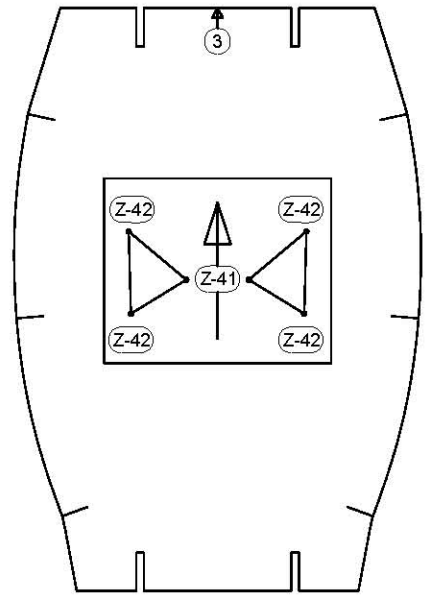
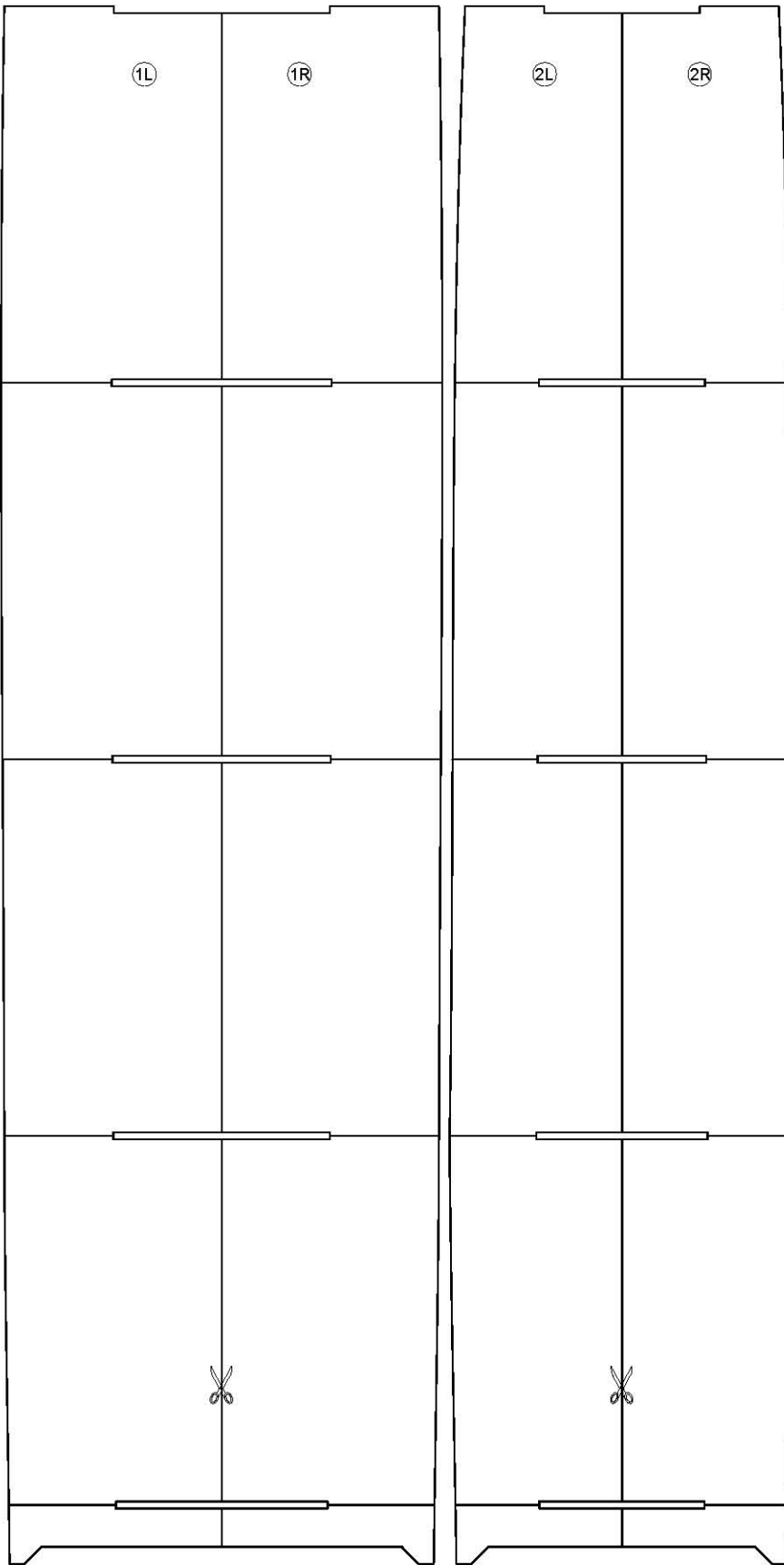

# U-Boat Type VIIC 1/72 Scale

F

70 grms + 1 mm CardBoard

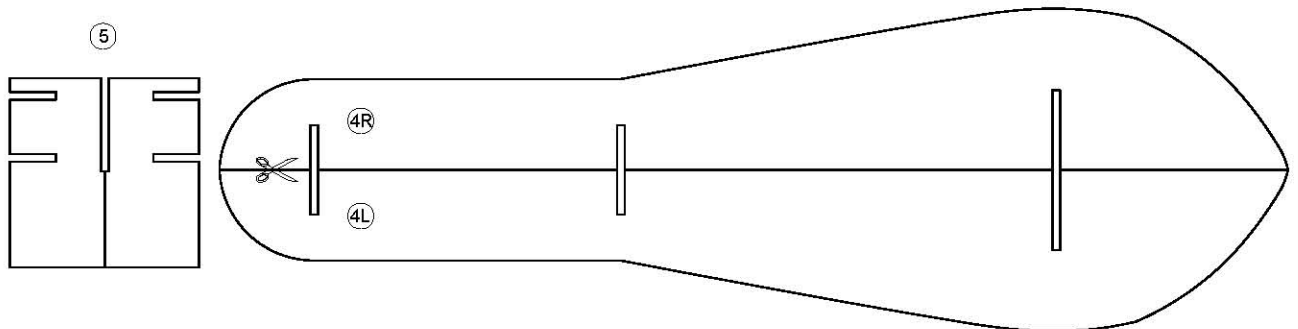
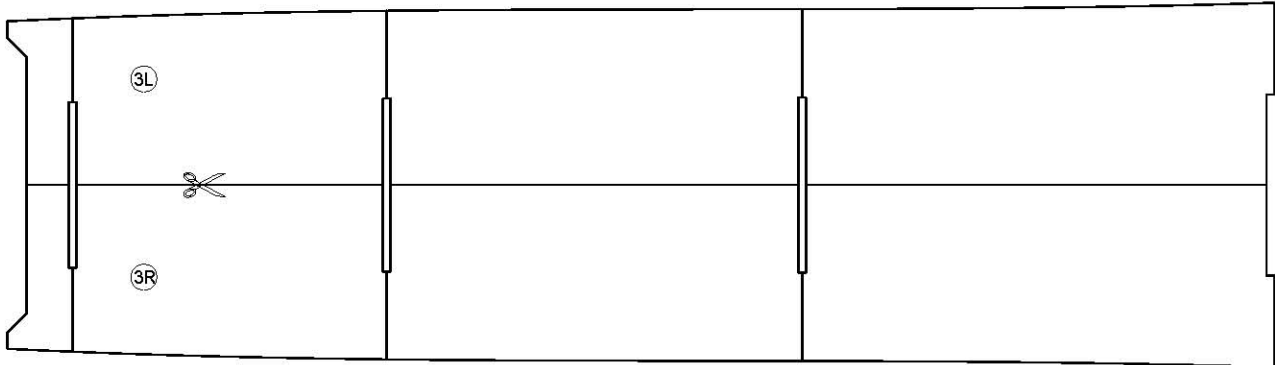
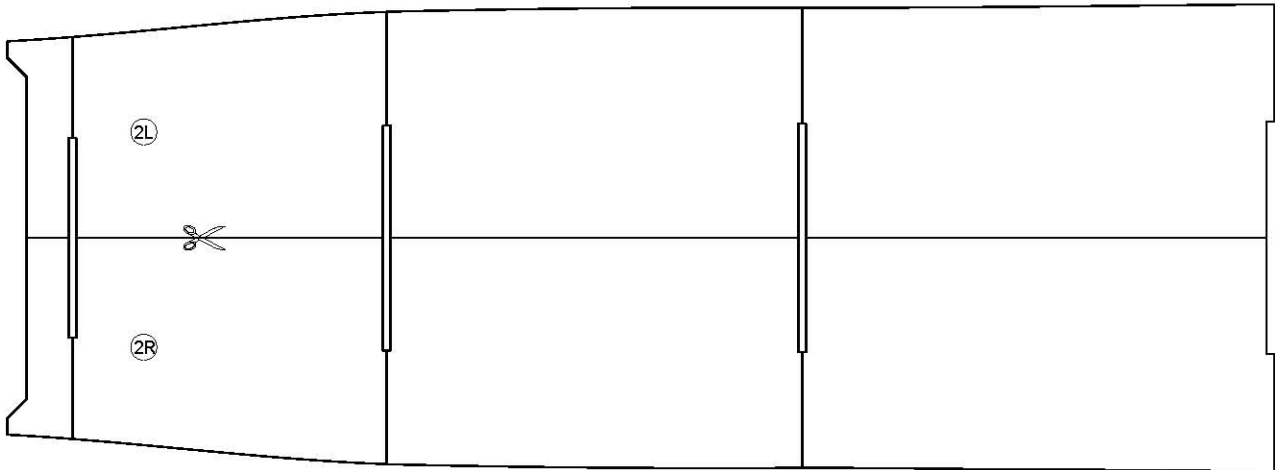
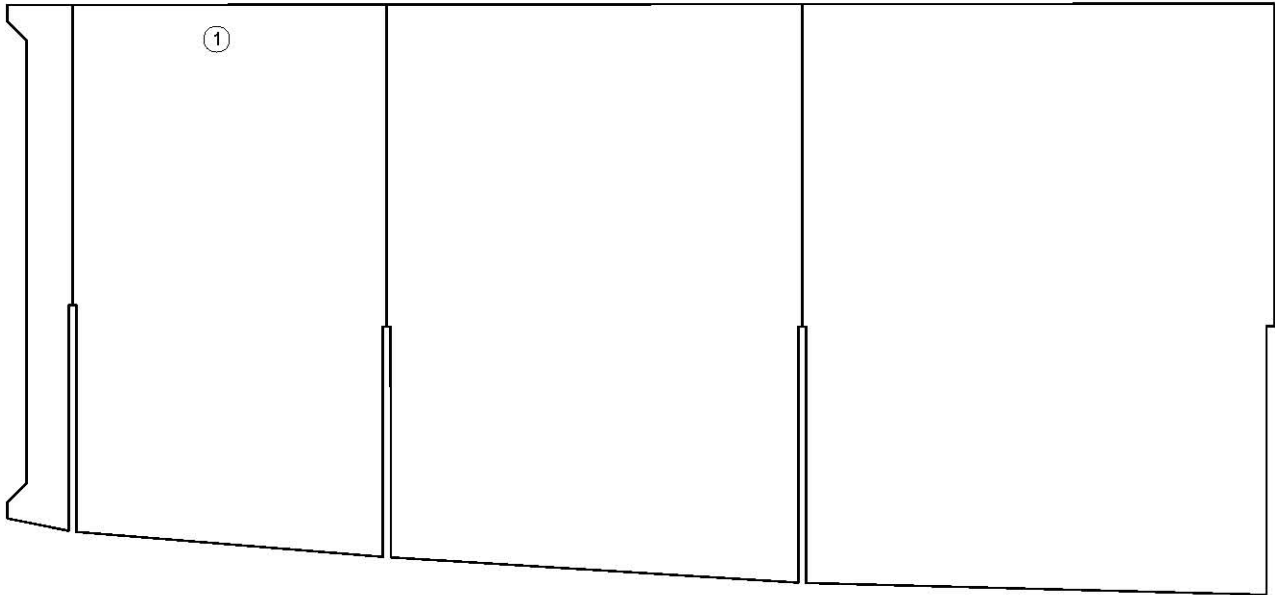

# U-Boat Type VIIC 1/72 Scale

G

70 grms + 1mm Cardboard

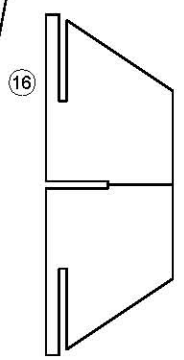
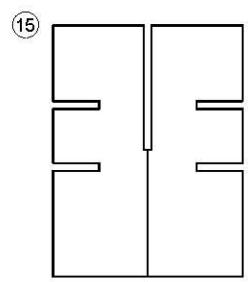
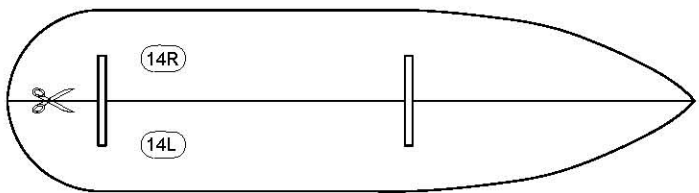
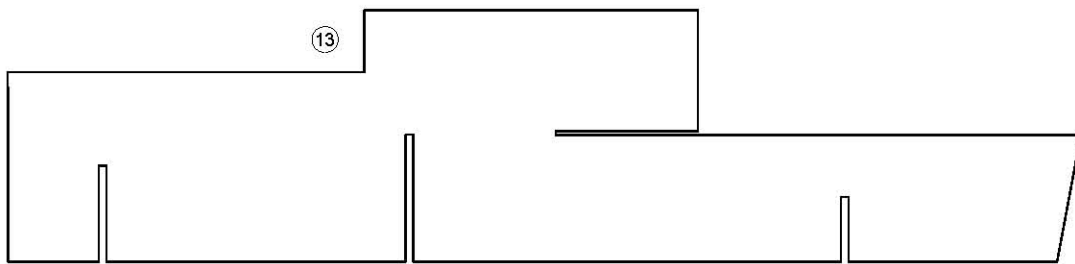
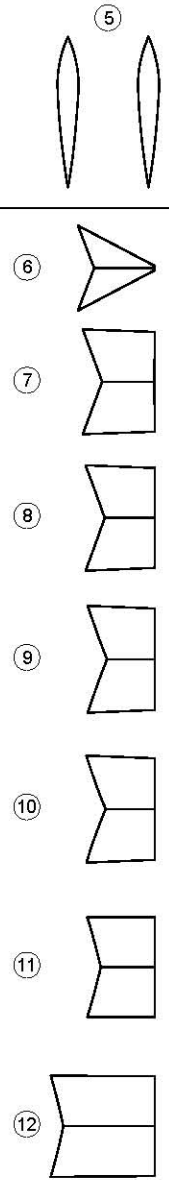
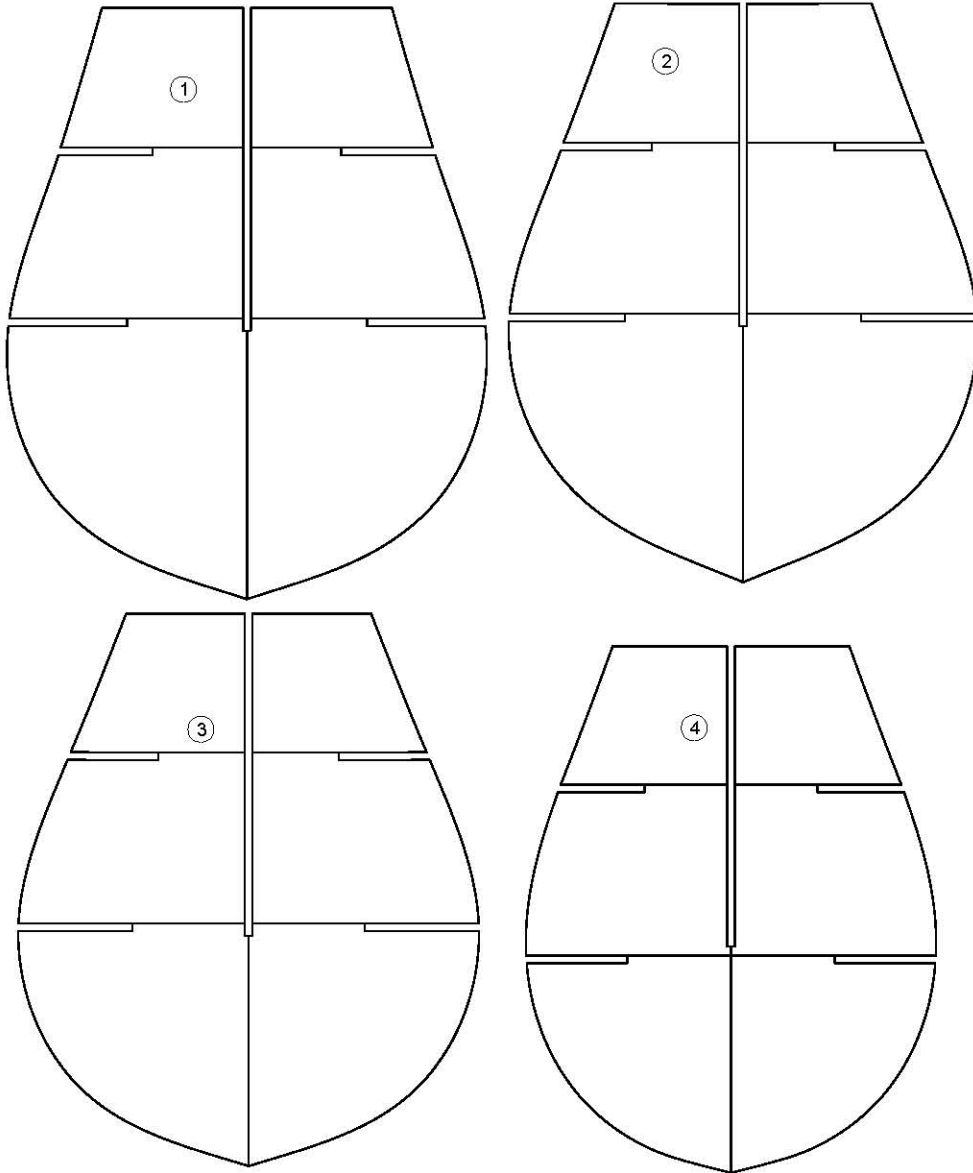

# U-Boat Type VIIC 1/72 Scale

H

70 grms + 1 mm CardBoard

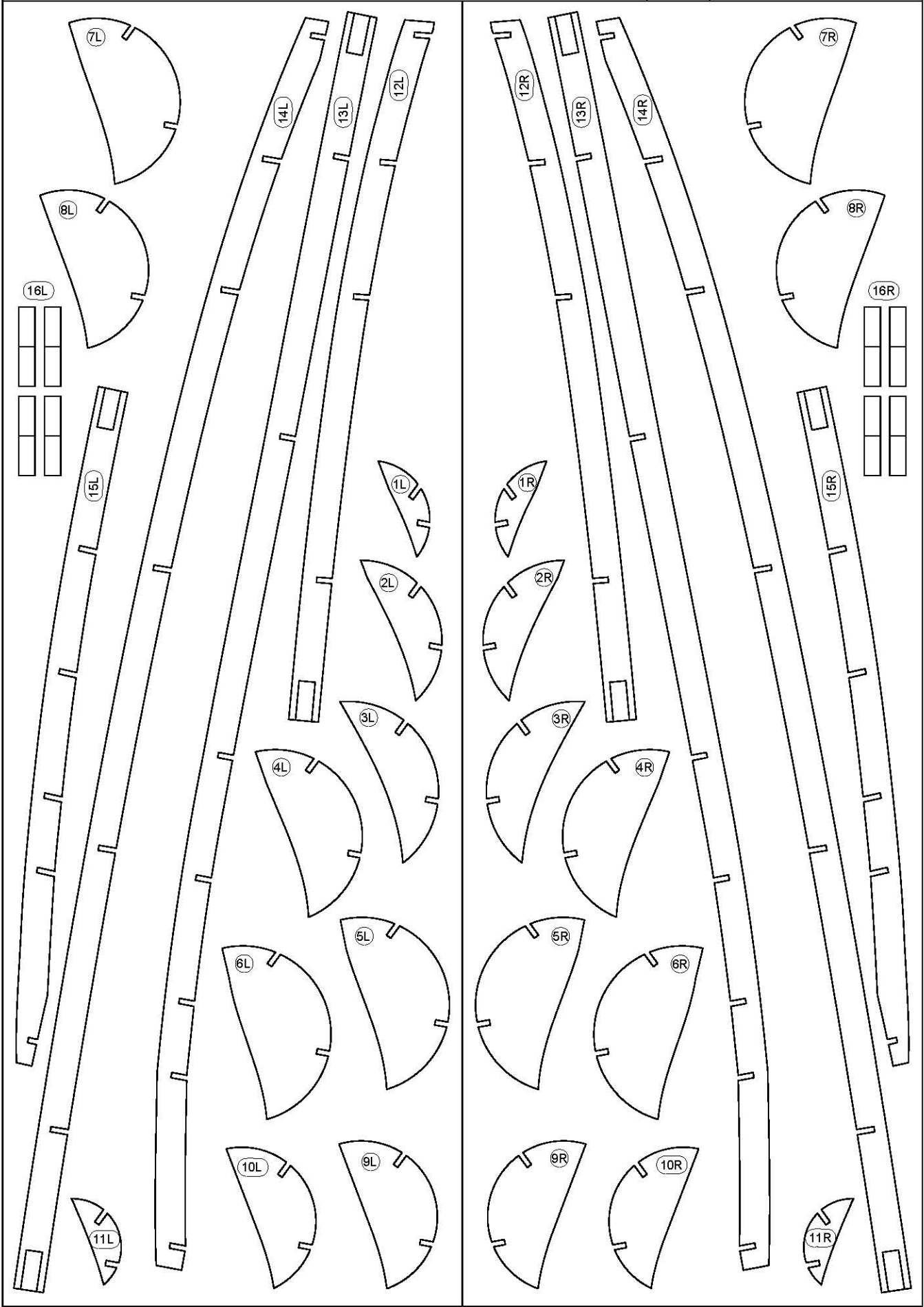



# U-Boat Type VIIC 1/72 Scale

i

70 grms + 1 mm CardBoard

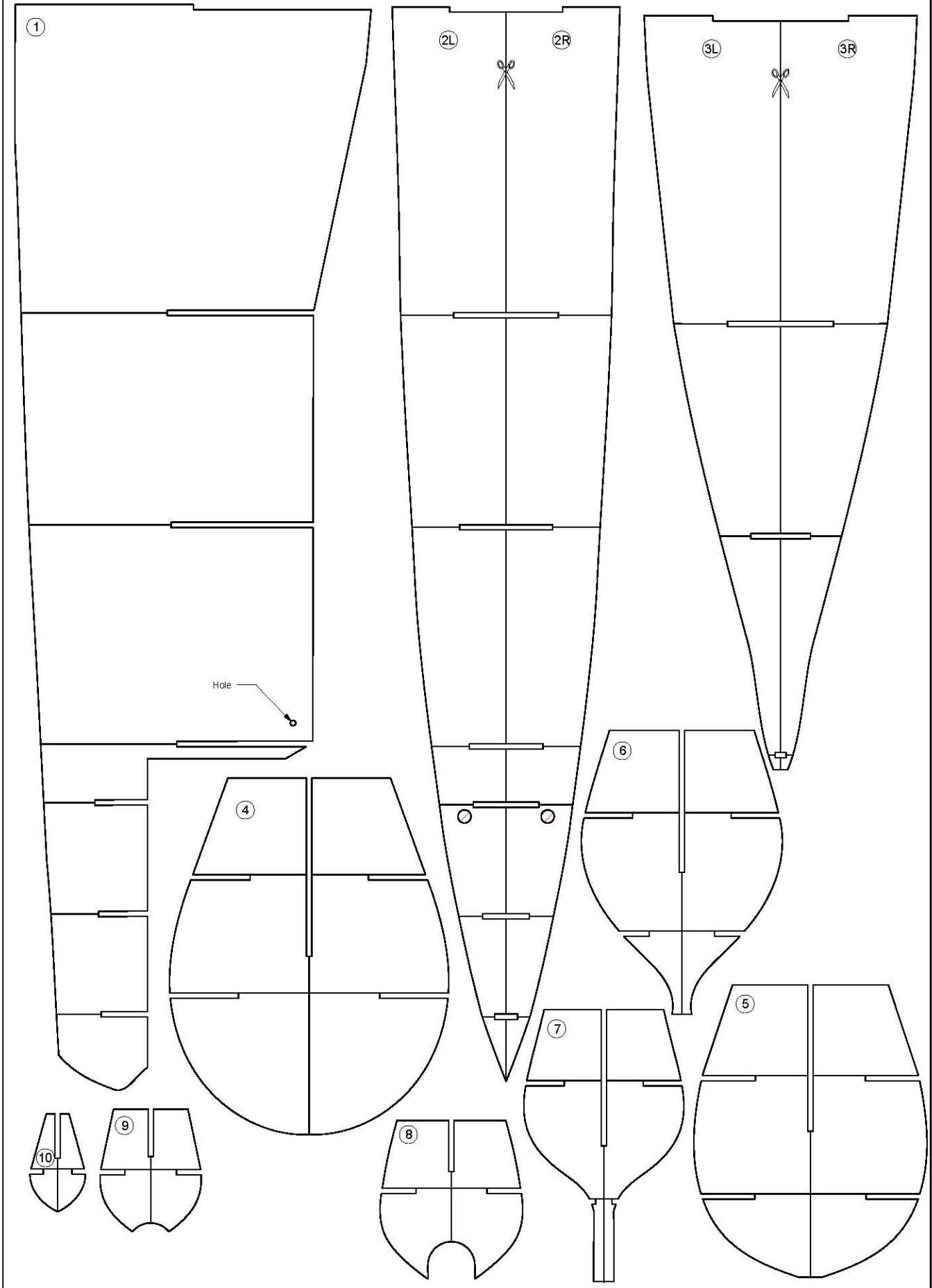

# U-Boat Type VIIC 1/72 Scale

J

190 grms

①



②

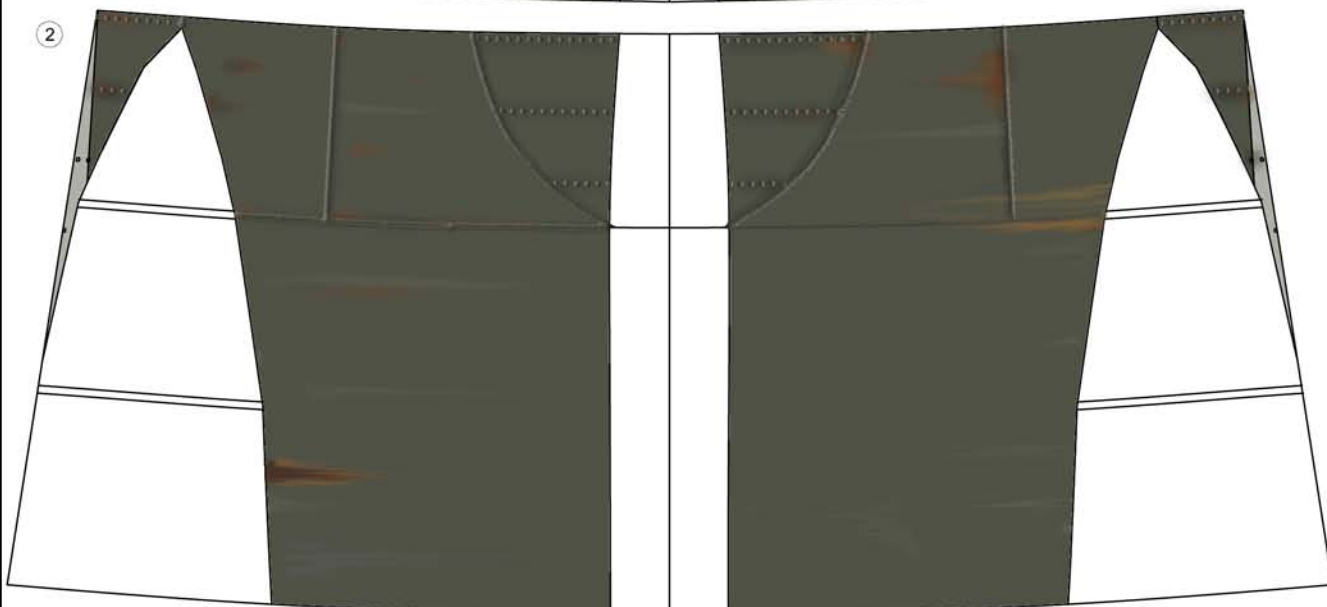

④L



③L



④R



③R



# U-Boat Type VIIC 1/72 Scale

K

190 grms

2R

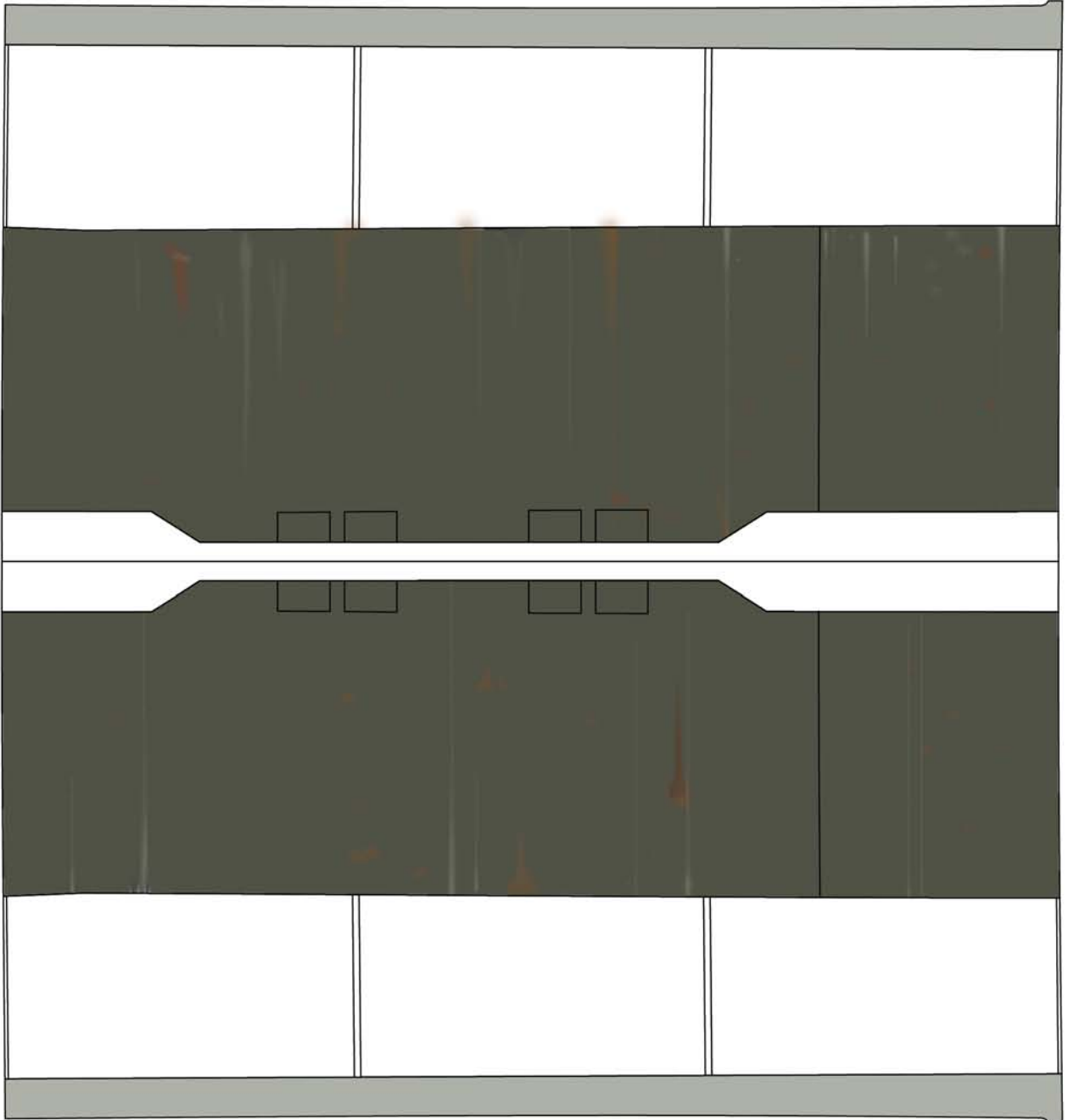

1

2L



# U-Boat Type VIIC 1/72 Scale

L

190 grms

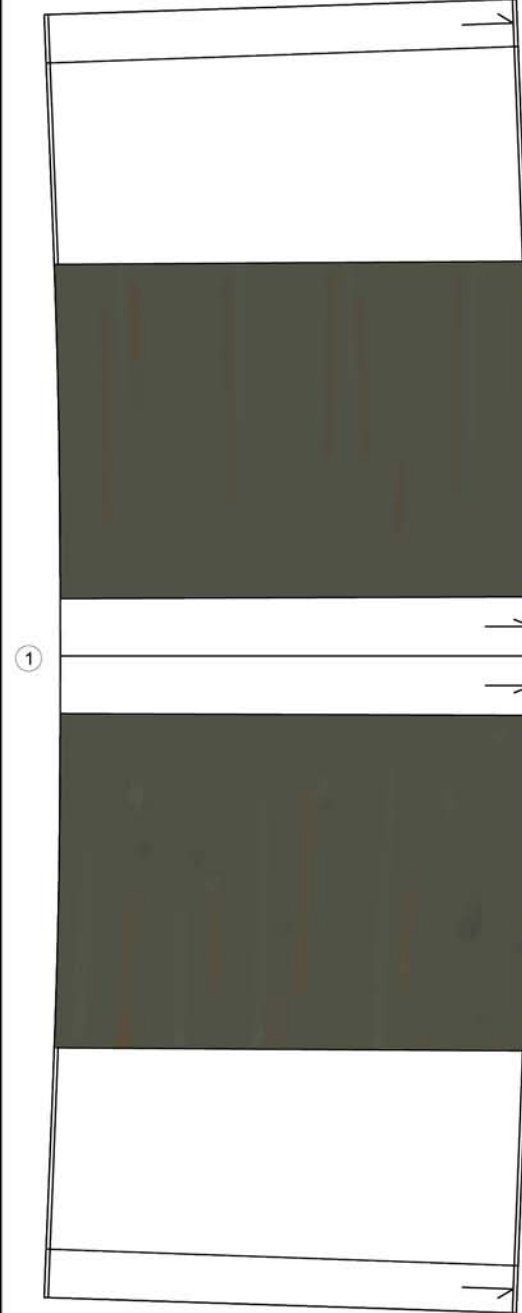
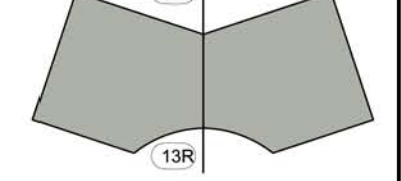
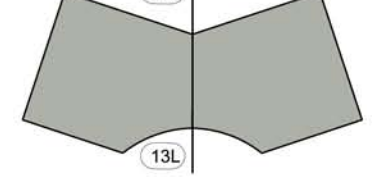
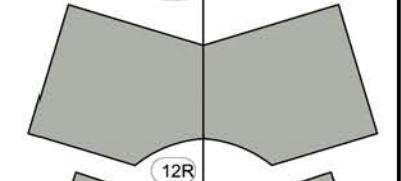
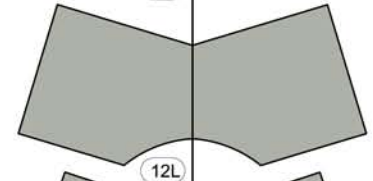
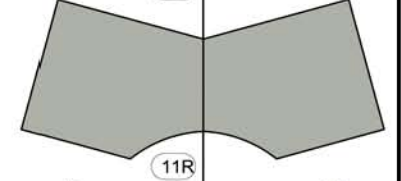
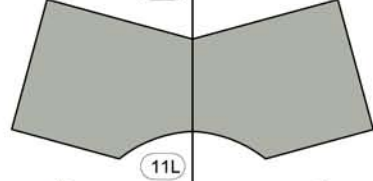
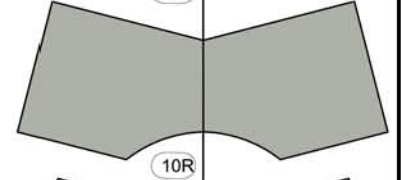
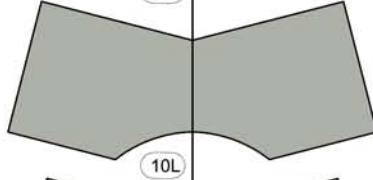
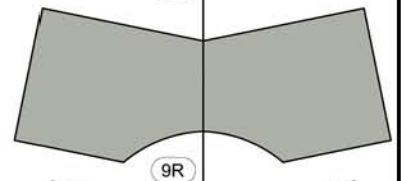
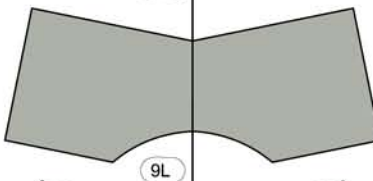
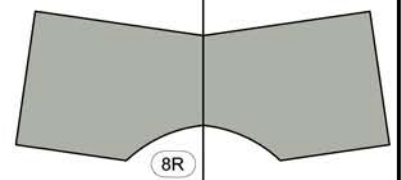
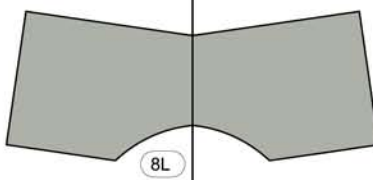
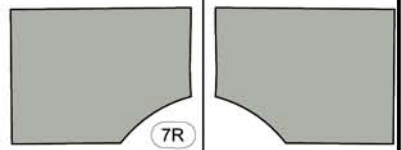
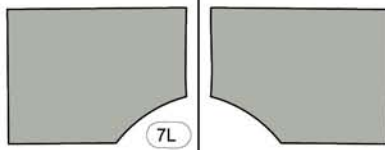
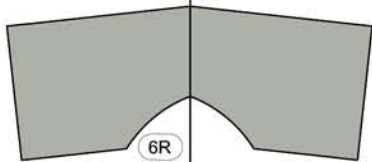
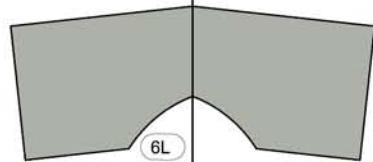
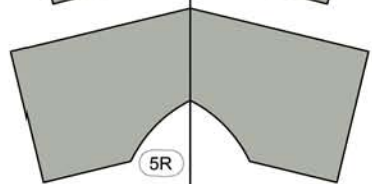
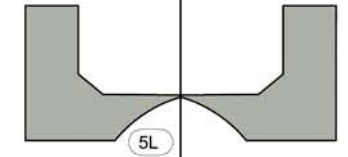
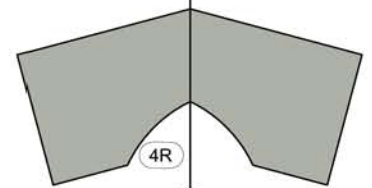
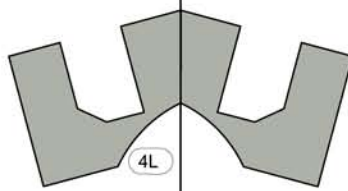
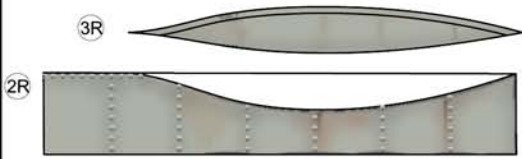

# U-Boat Type VIIC 1/72 Scale

M

190 grms

1L

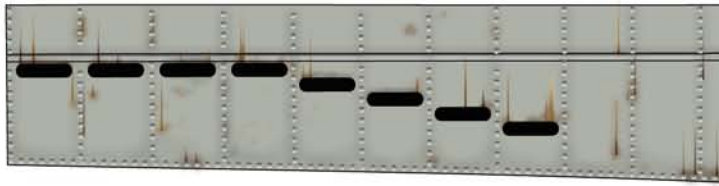

2L

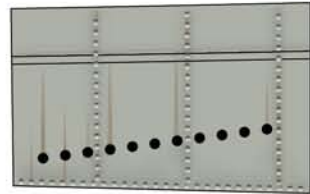

1R

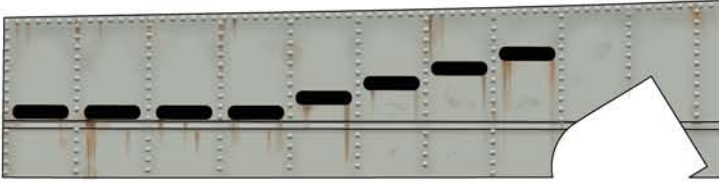

2R

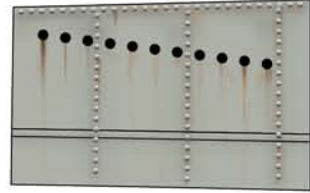

3



4

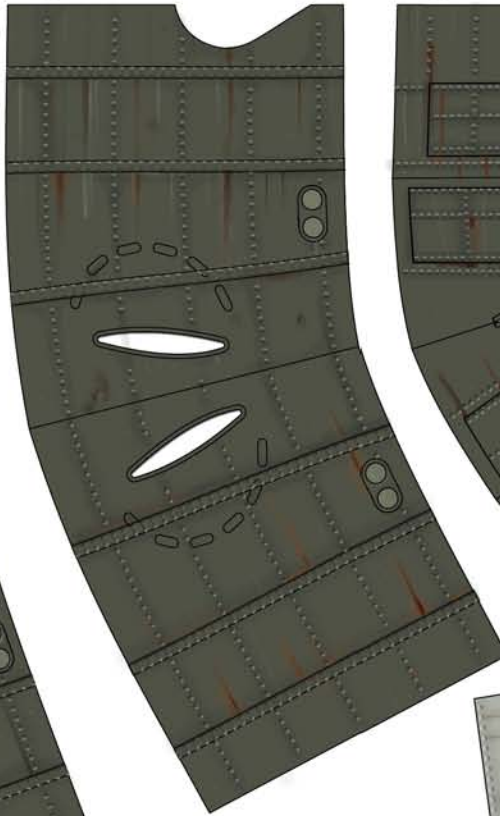

5

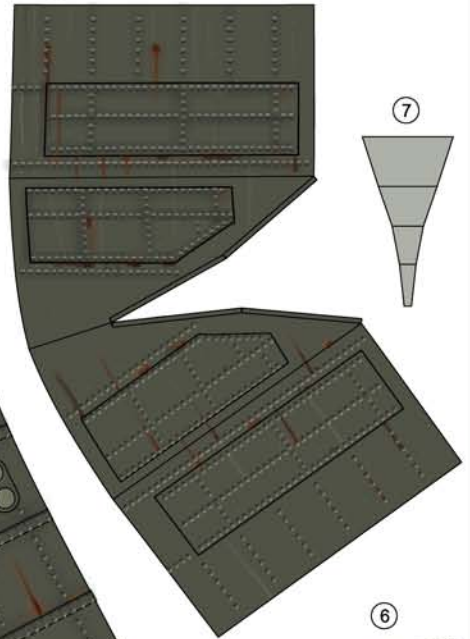

7

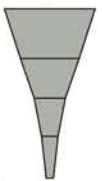

6

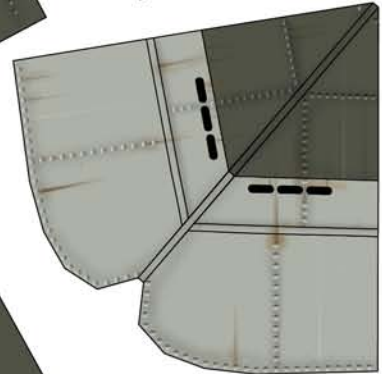

11

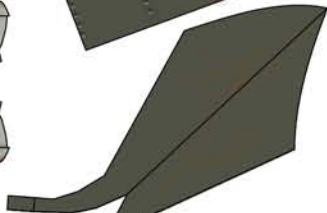

12L



10



9

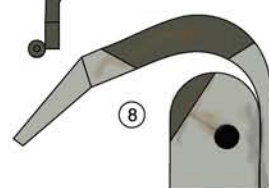

8

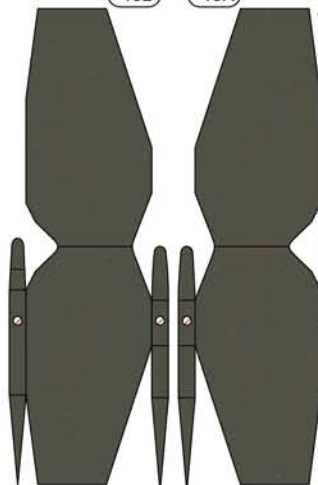

13L

13R

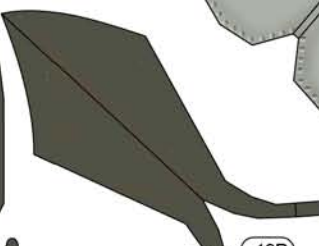

12R

U-BOAT TYPE VII C 1/72 Scale

PAGE: N

PAPER 70 grms

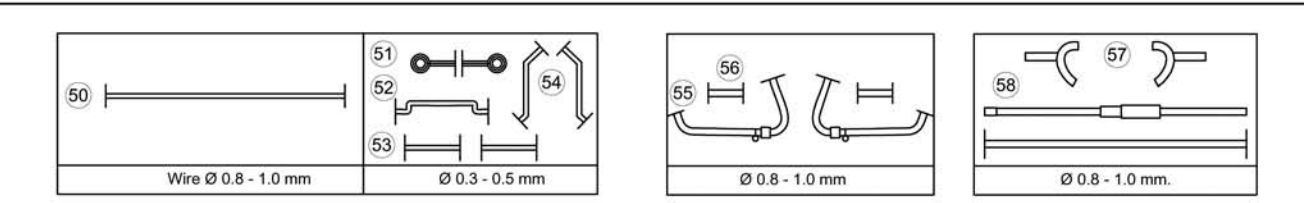
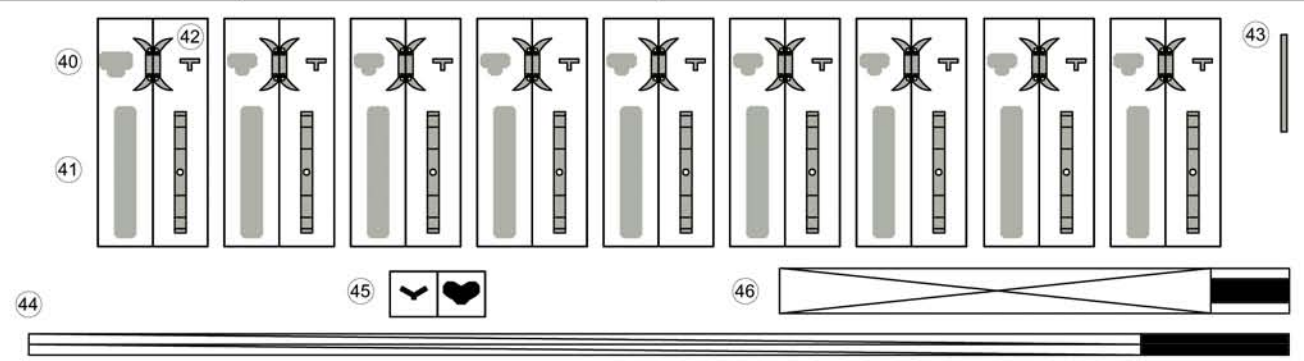
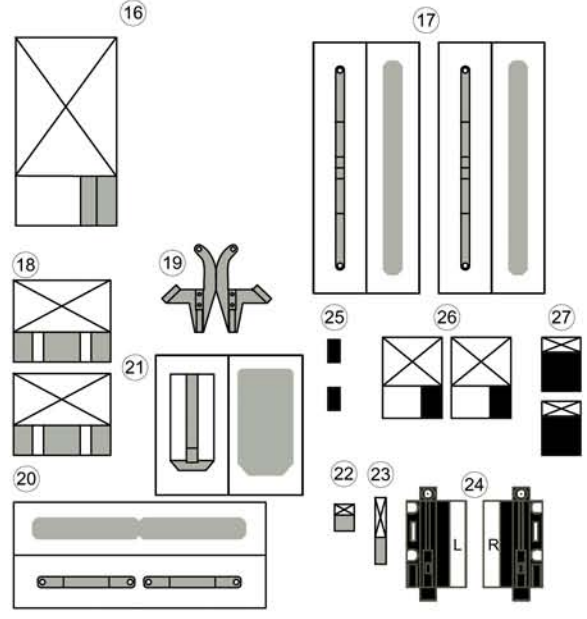
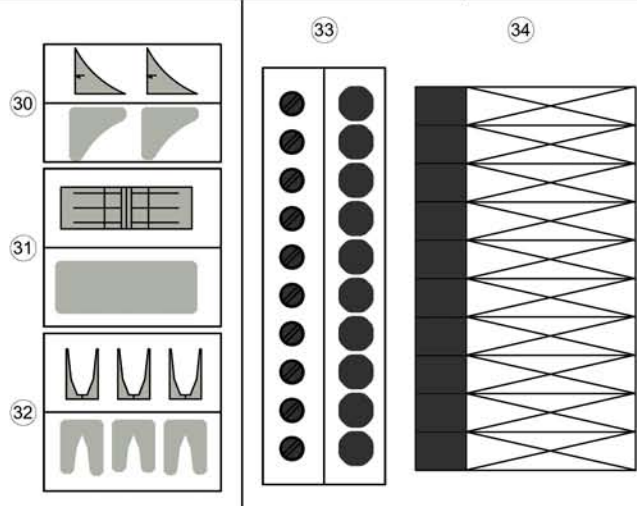
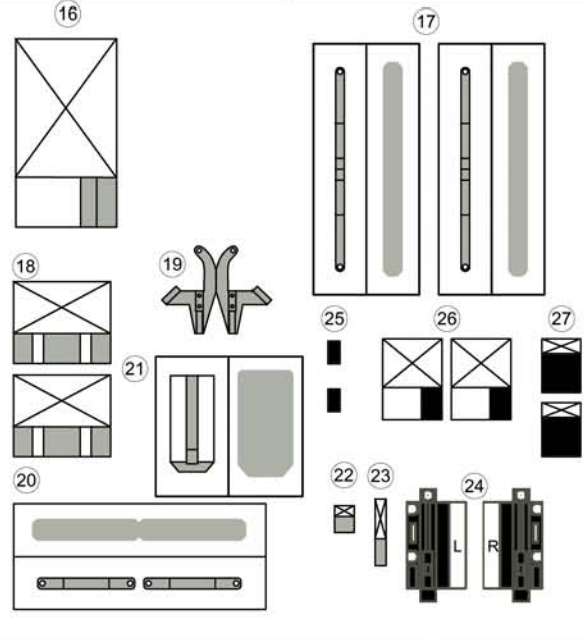
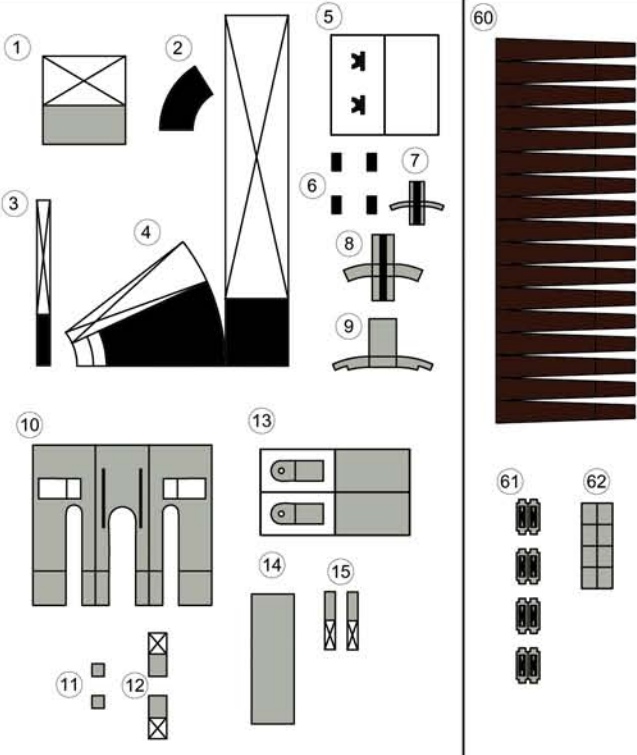

# U-Boat Type VIIC 1/72 Scale

O

190 grms

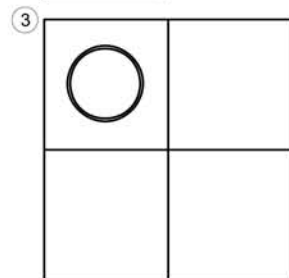
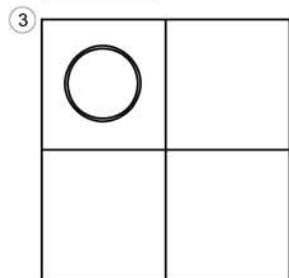
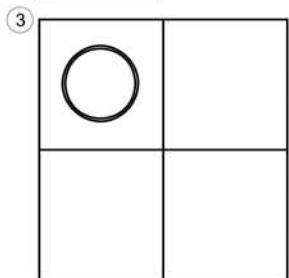
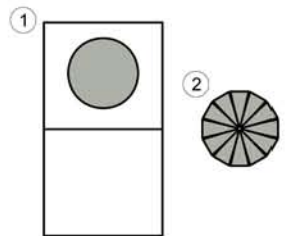
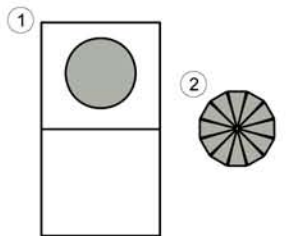
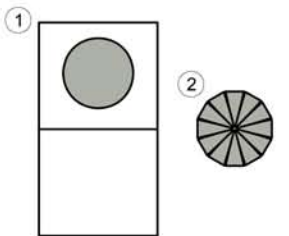
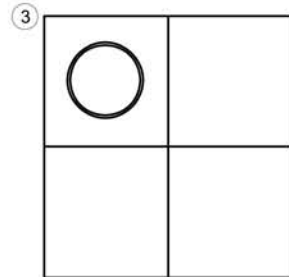
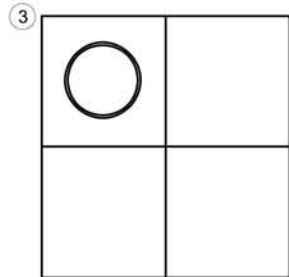
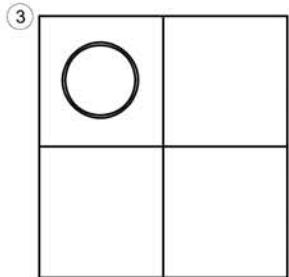
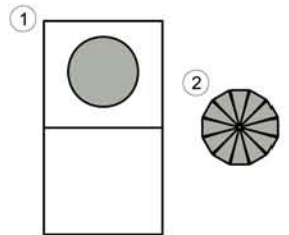
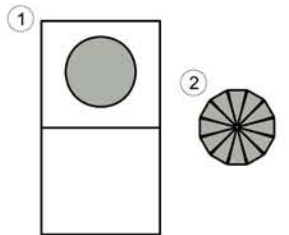
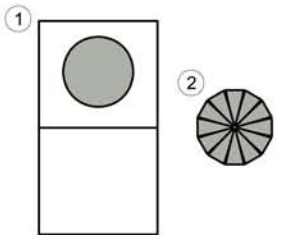
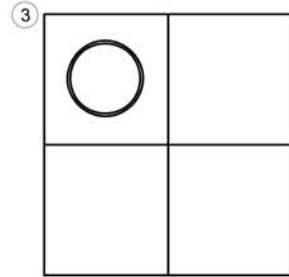
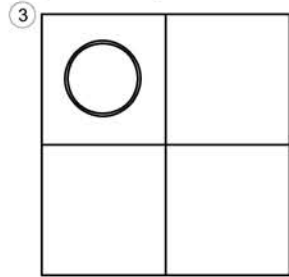
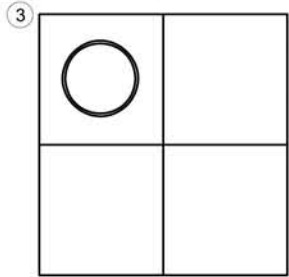
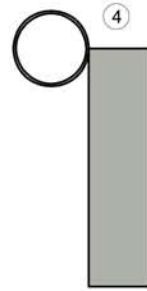
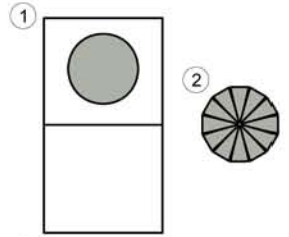
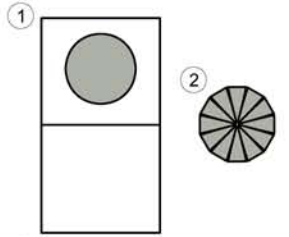
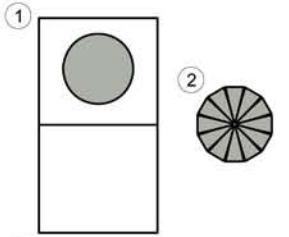

①

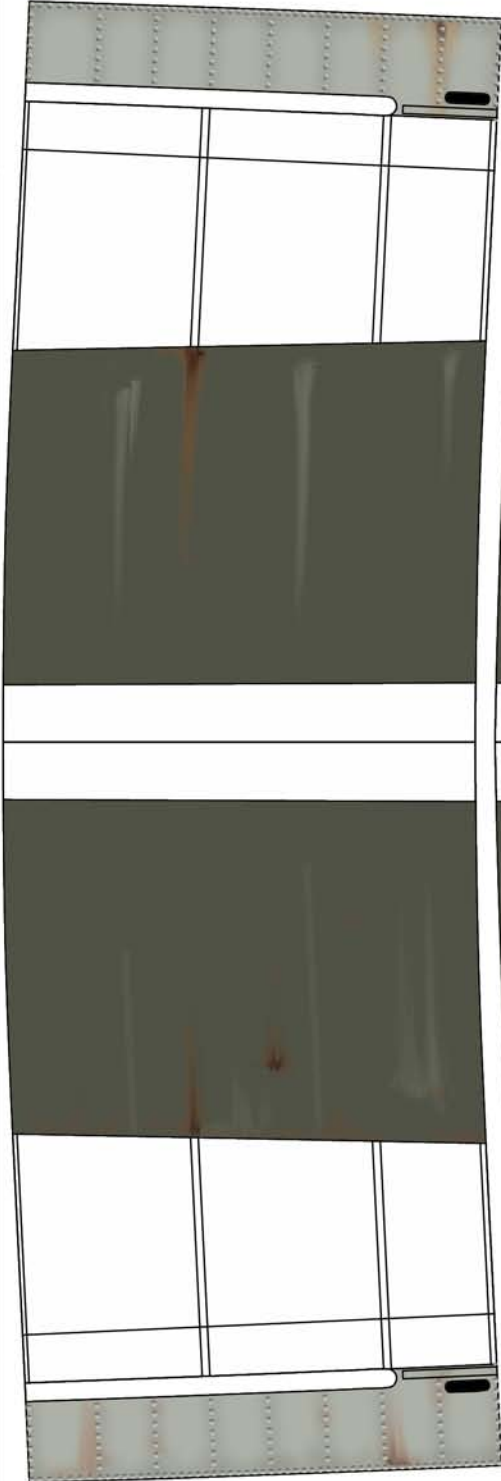

②

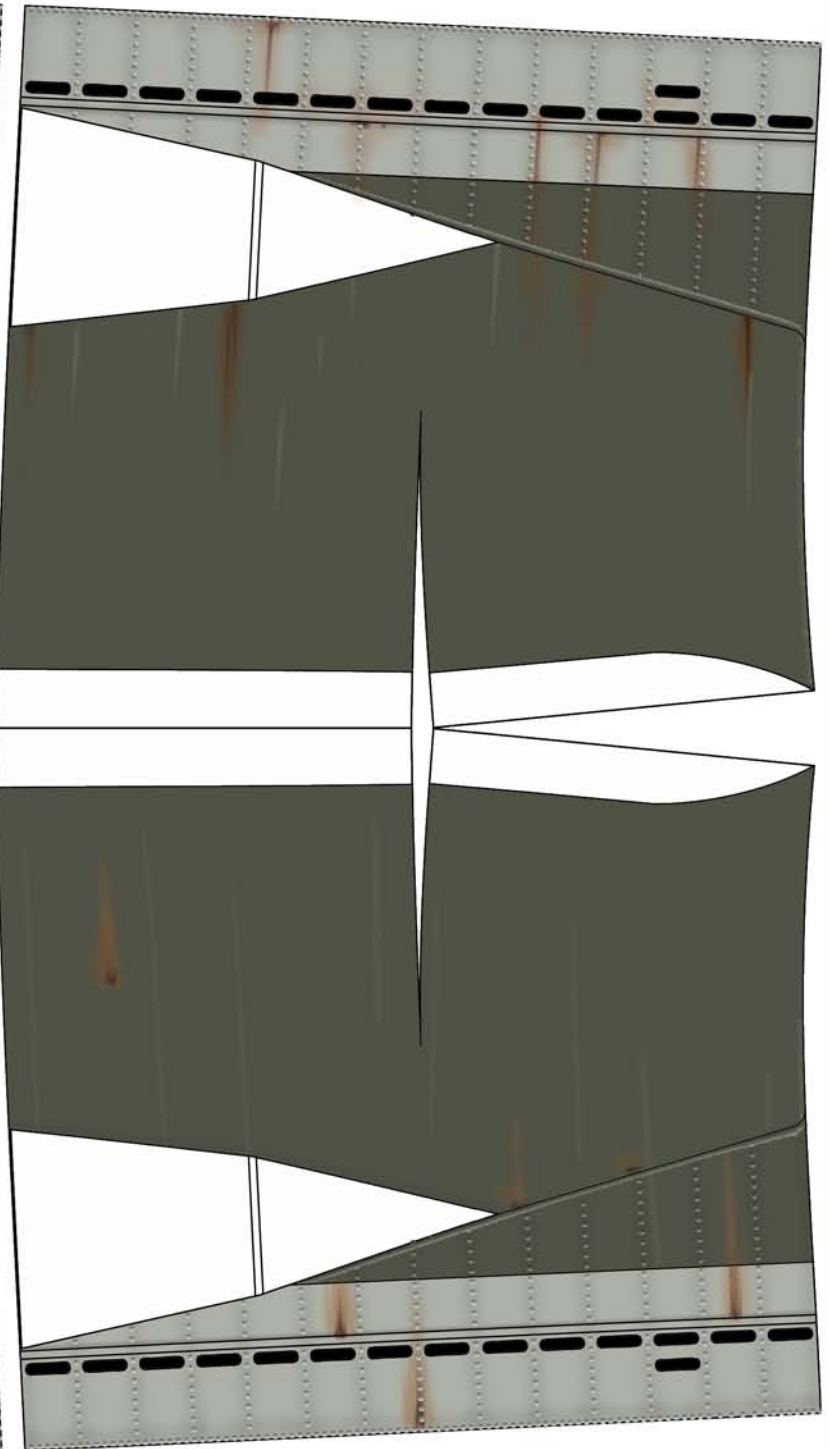



# U-Boat Type VIIC 1/72 Scale

Q

190 grms

5L

4L

3L

2L

1L

1R

2R

3R

4R

5R

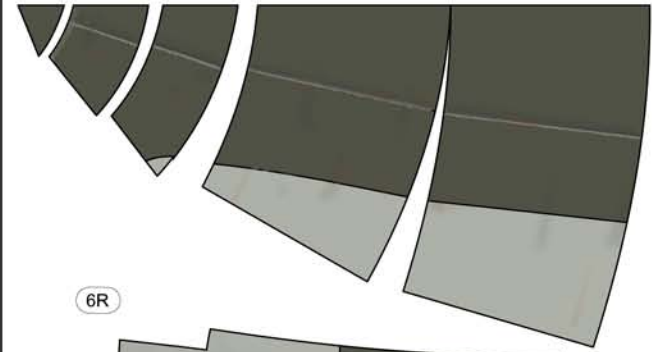
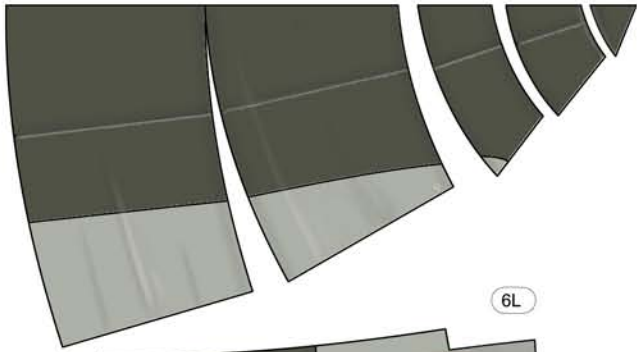

6L

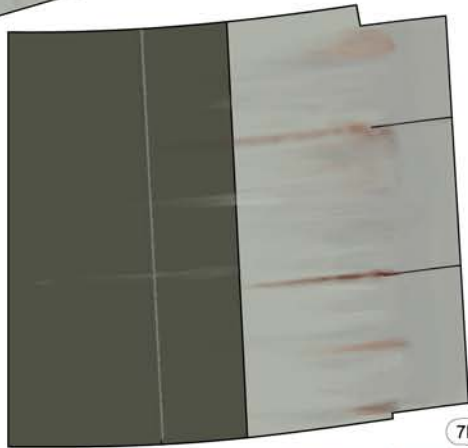

6R

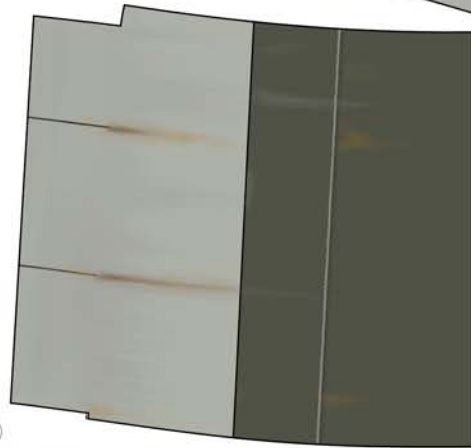

7L

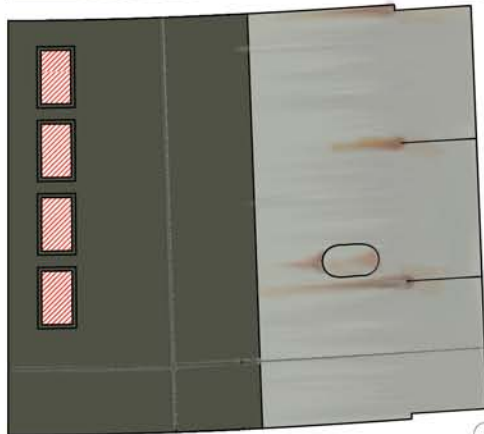

7R

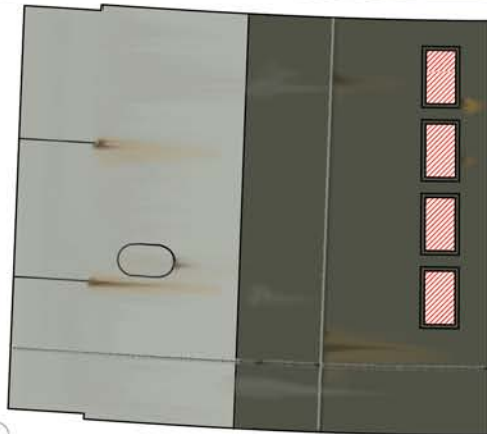

8L

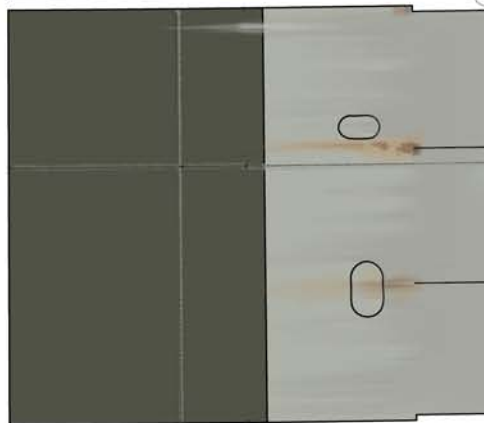

8R

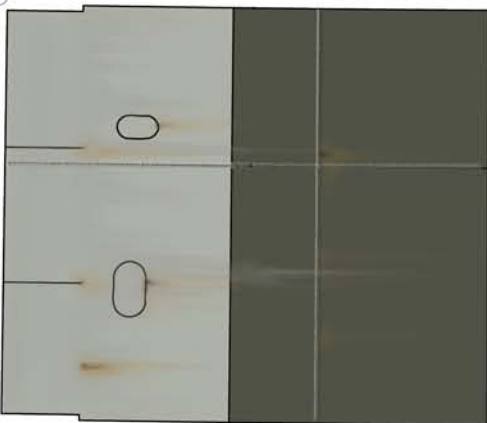

12L

11L

10L

9L

8L

8R

8R

9R

10R

11R

12R

# U-Boat Type VIIC 1/72 Scale

R

190 grms

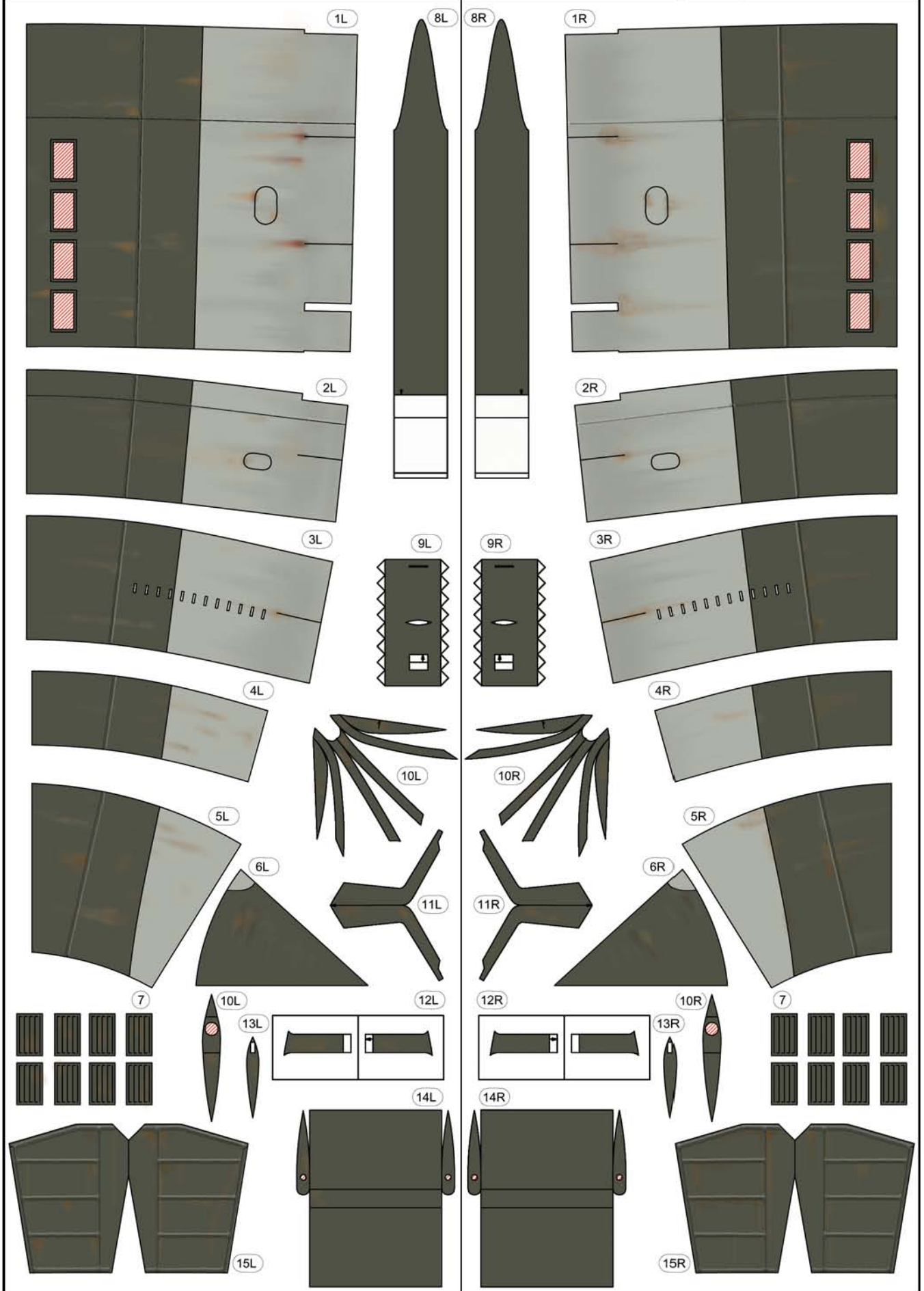

# U-Boat Type VIIC 1/72 Scale

S

190 grms

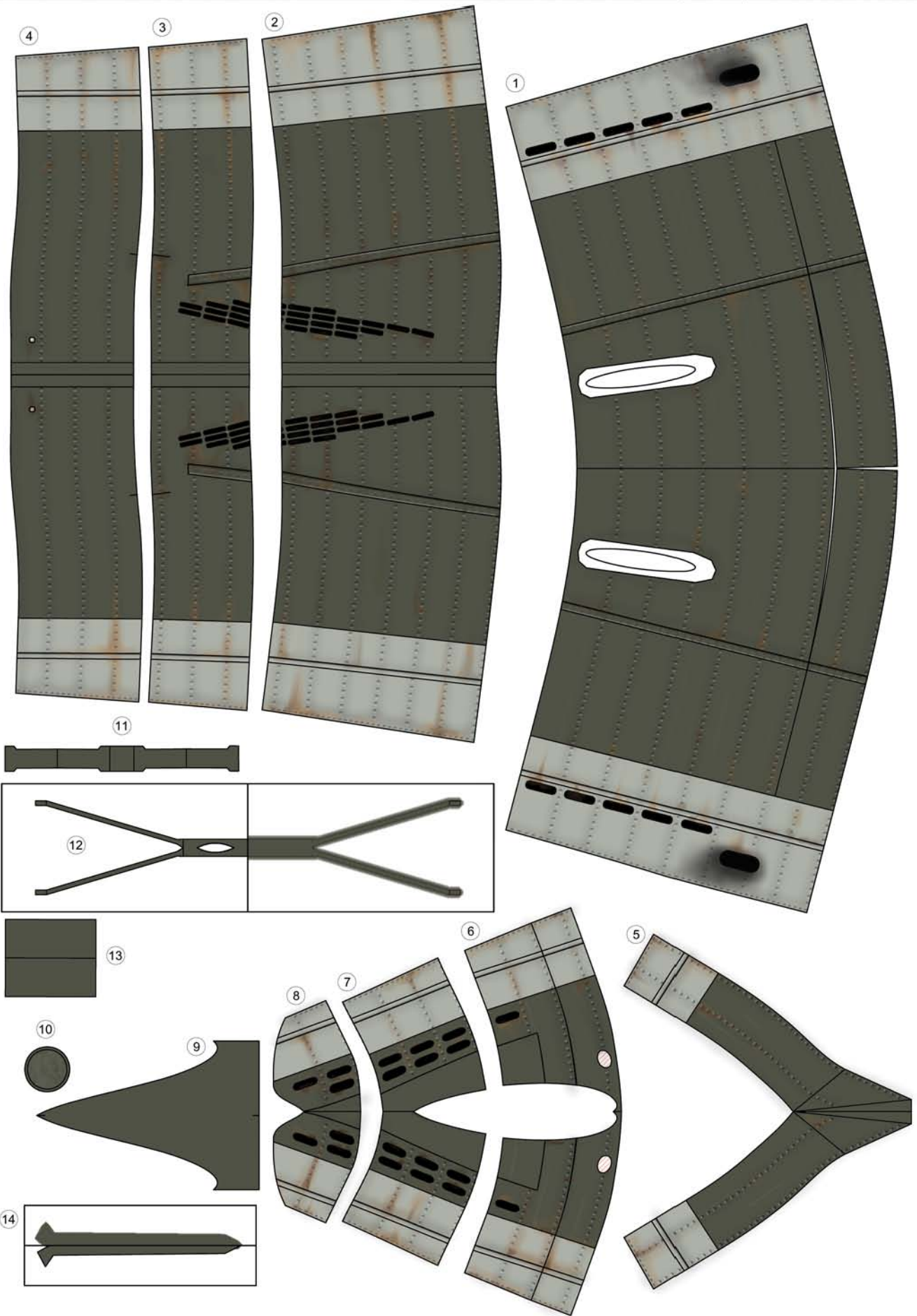

# U-Boat Type VIIC 1/72 Scale

# ST-1

70 grms

A-3a A-4a A-5a A-6a

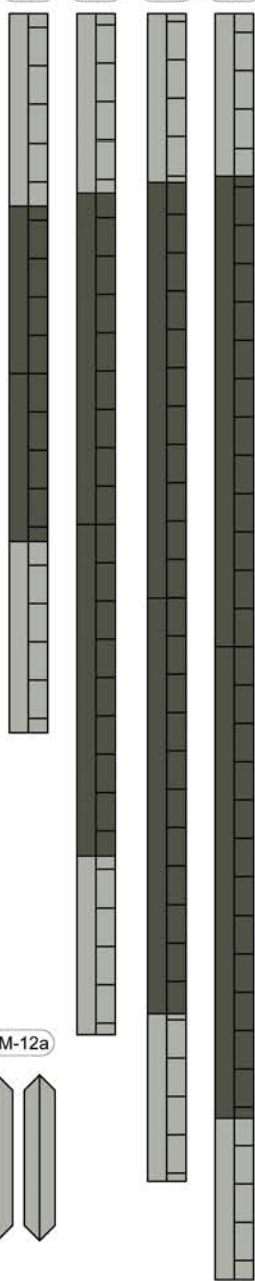

M-12a

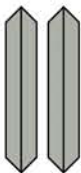

A-8a



A-8bL

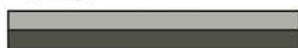

A-8bR



A-8c



C-1a C-2a C-3a C-4a C-5a

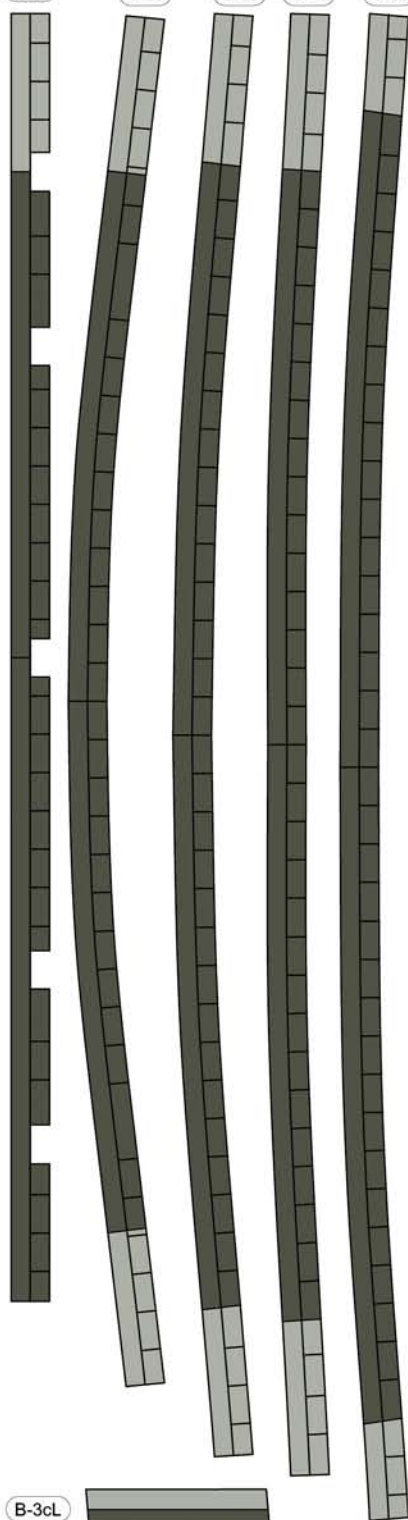

B-3cL



B-3cR

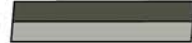

B-3b



B-3dL



B-3dR



C-6a C-7a D-2a D-3a D-4a

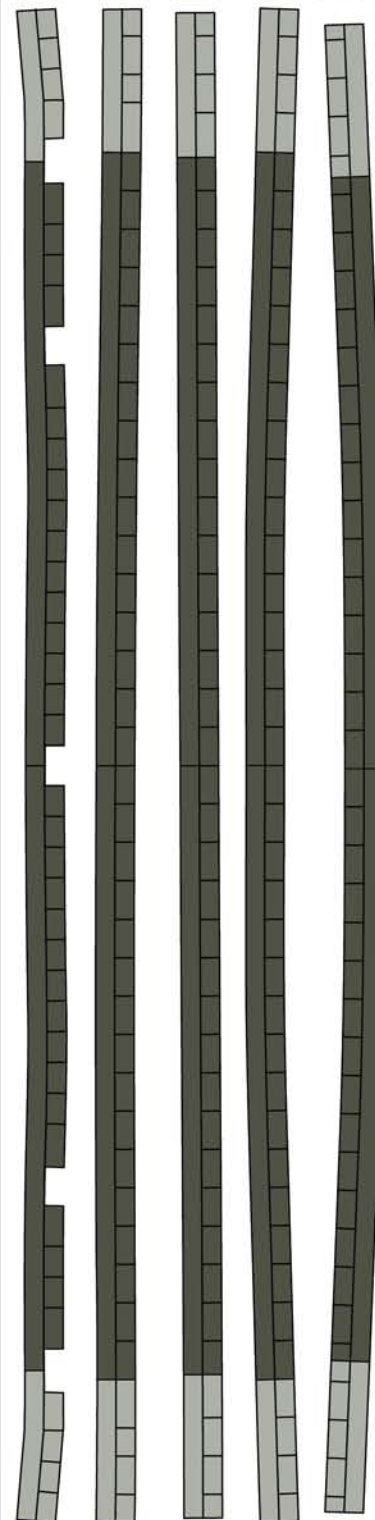

B-3a



E-2a

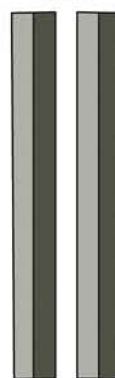

E-2b

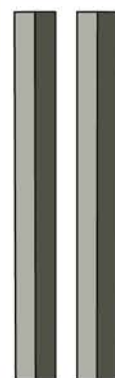

E-2c



E-2d

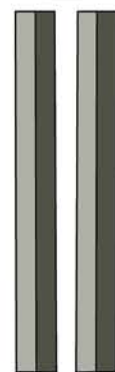

# U-Boat Type VIIC 1/72 Scale

ST-2

70 grms

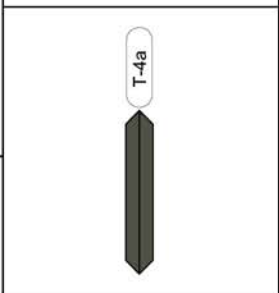
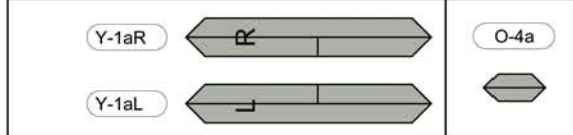
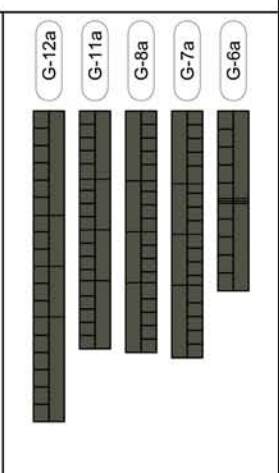
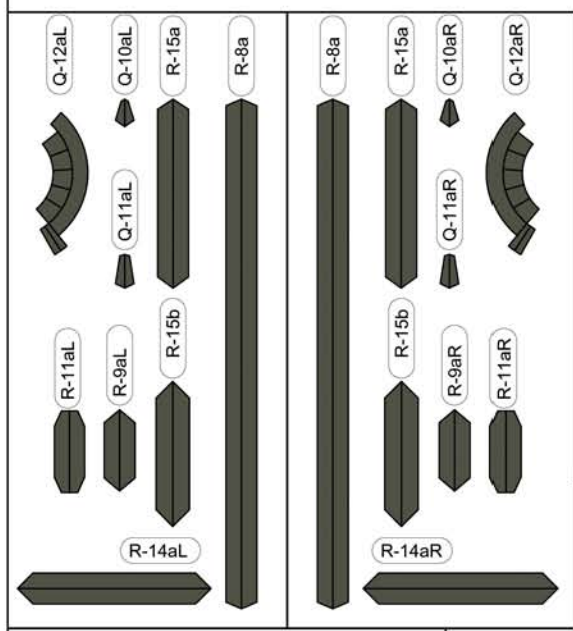
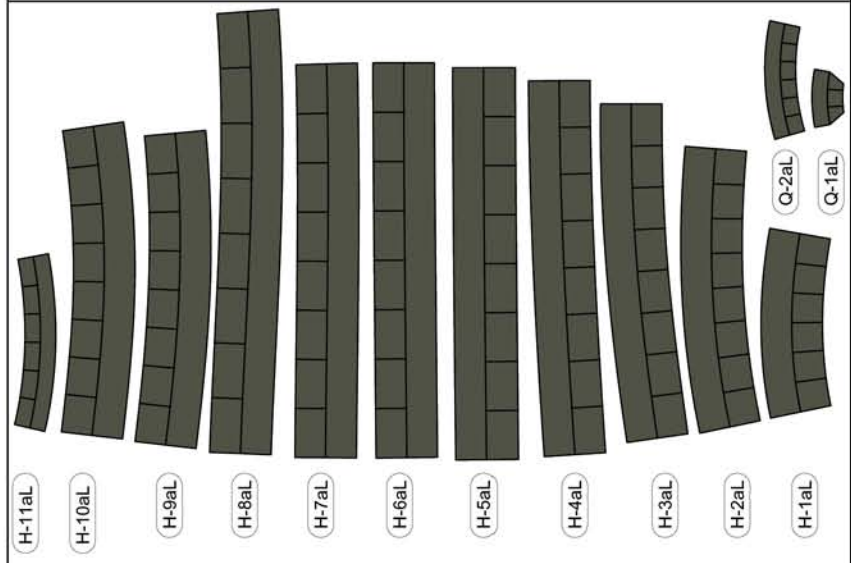
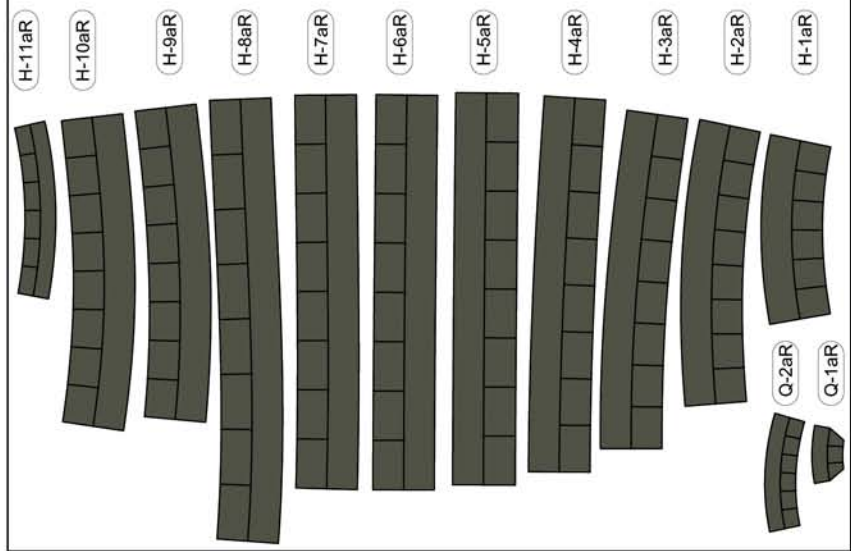
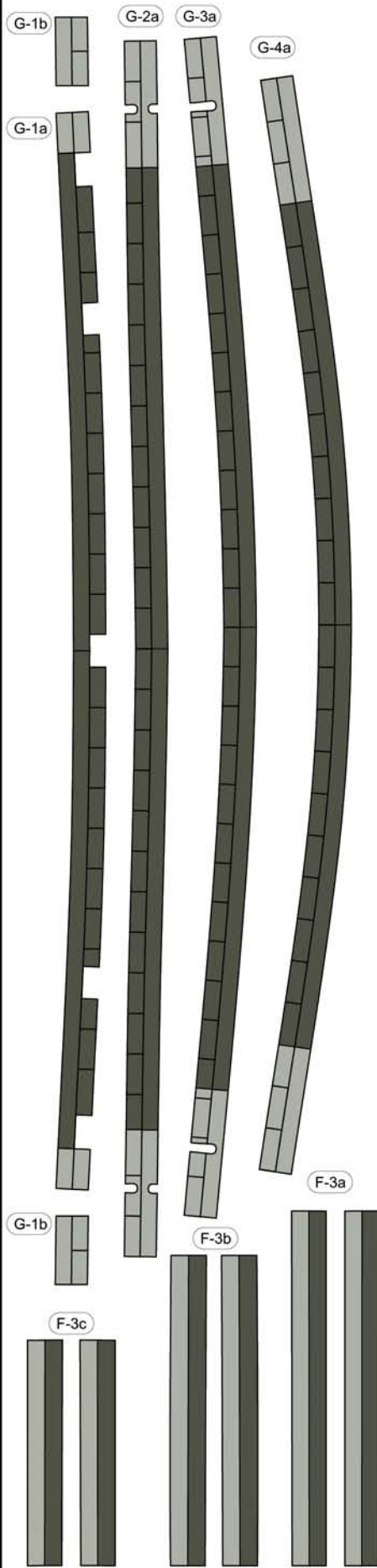

# U-Boat Type VIIC 1/72 Scale

ST-3

70 grms

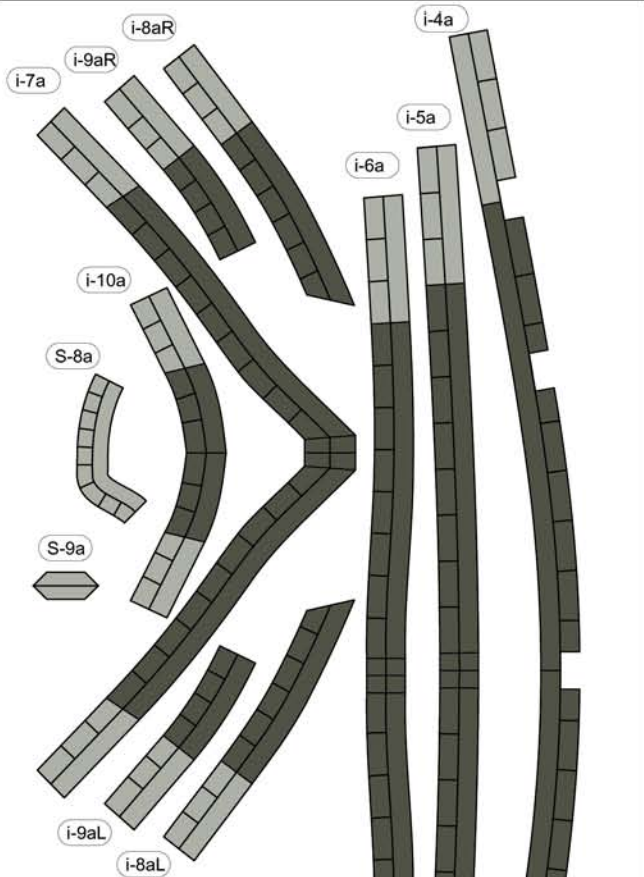

Y-4a

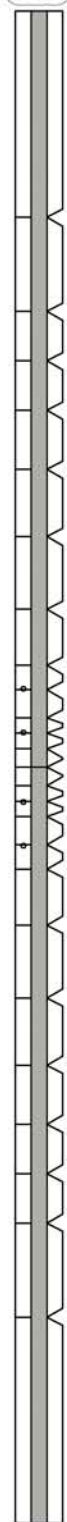

V-2a

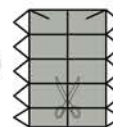

V-2b

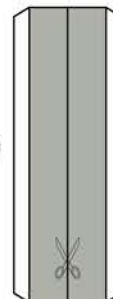

V-3a

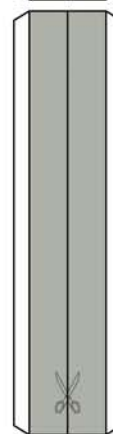

V-3b

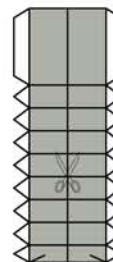

Y-27a



U-11a

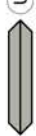

U-14a



U-17a



U-6a



U-16a



U-18a

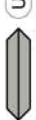

U-18a



U-24a



U-24b



Y-15a

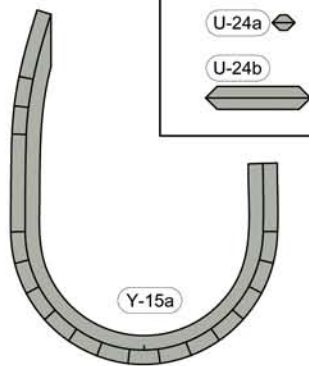

U-28a



U-31a



U-32a



U-34a



# U-Boat Type VIIC 1/72 Scale

T

190 grms

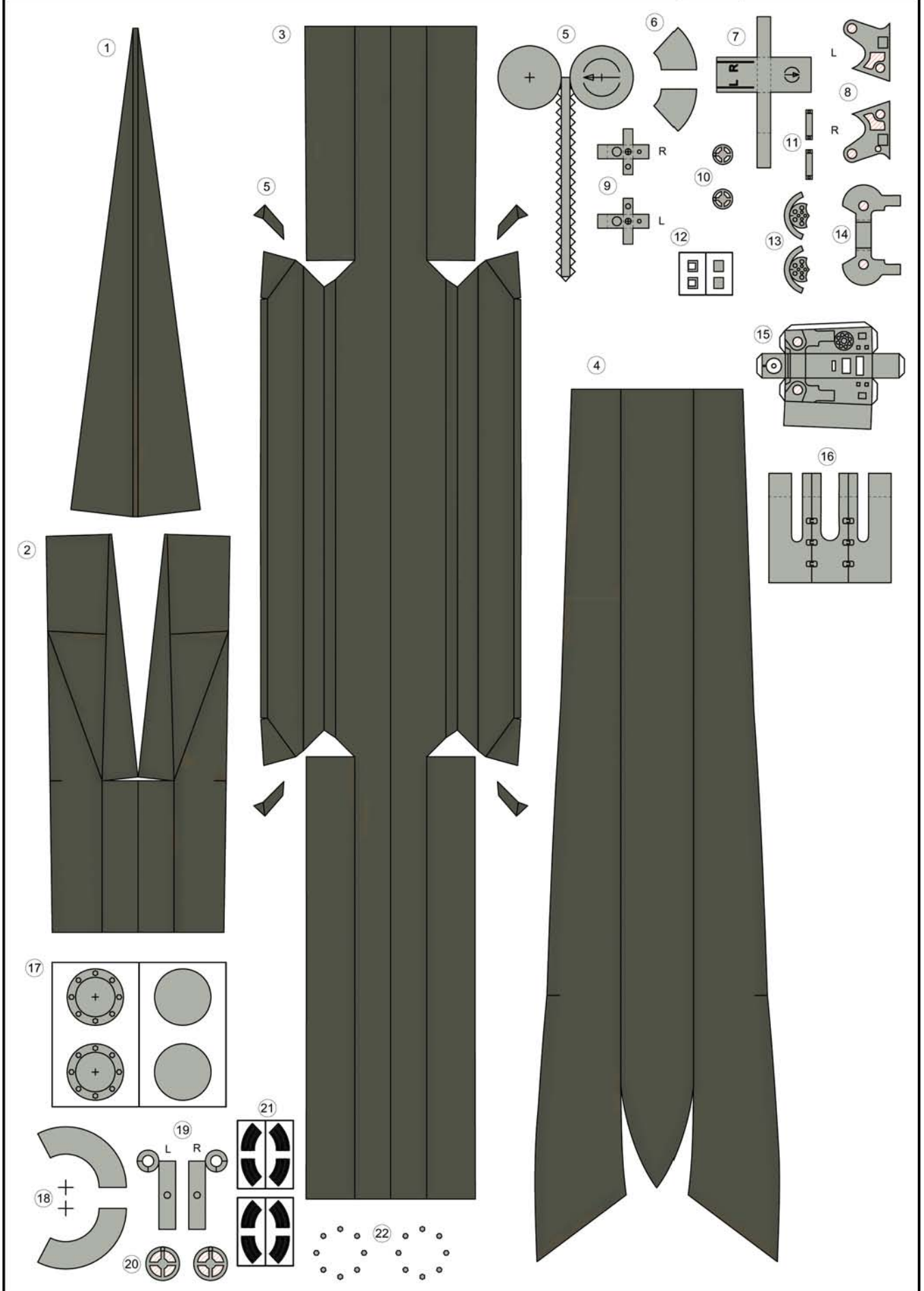

# U-Boat Type VIIC 1/72 Scale

U

190 grms

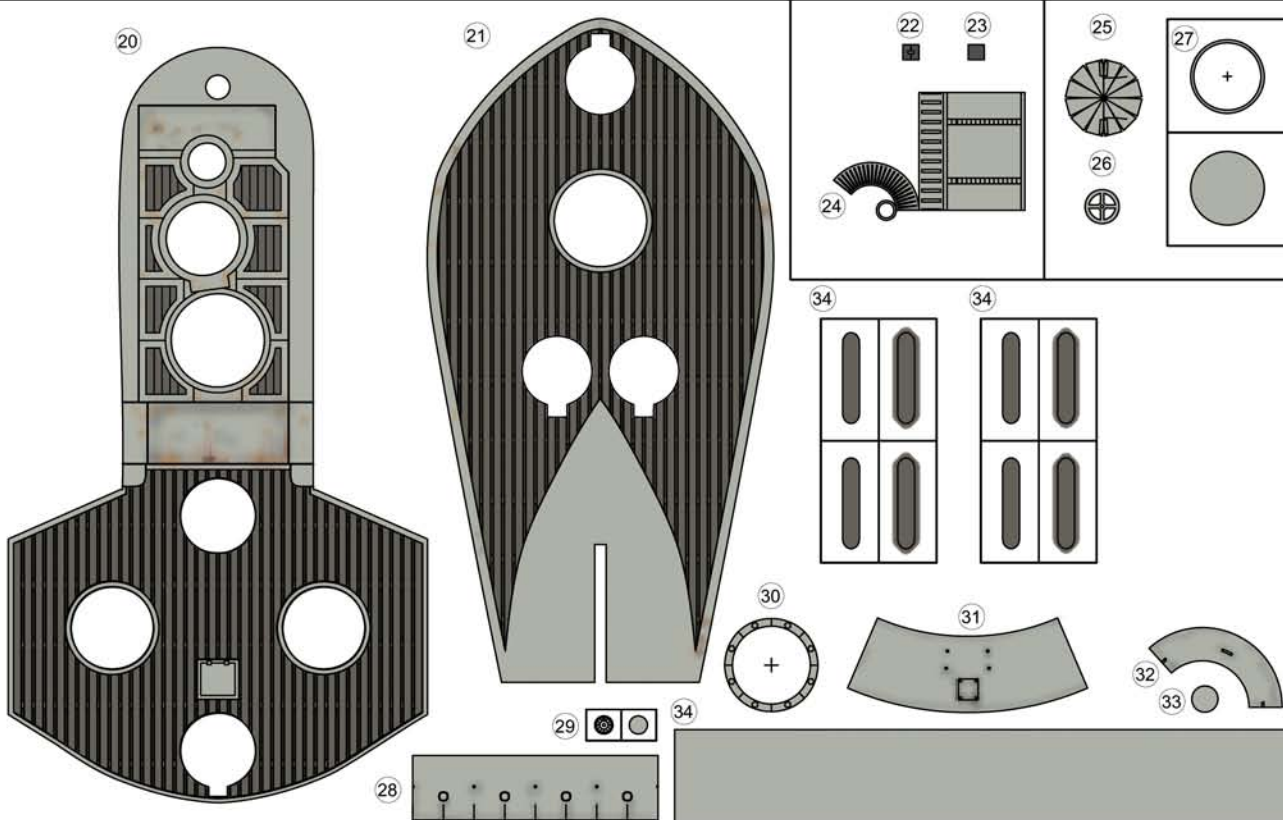
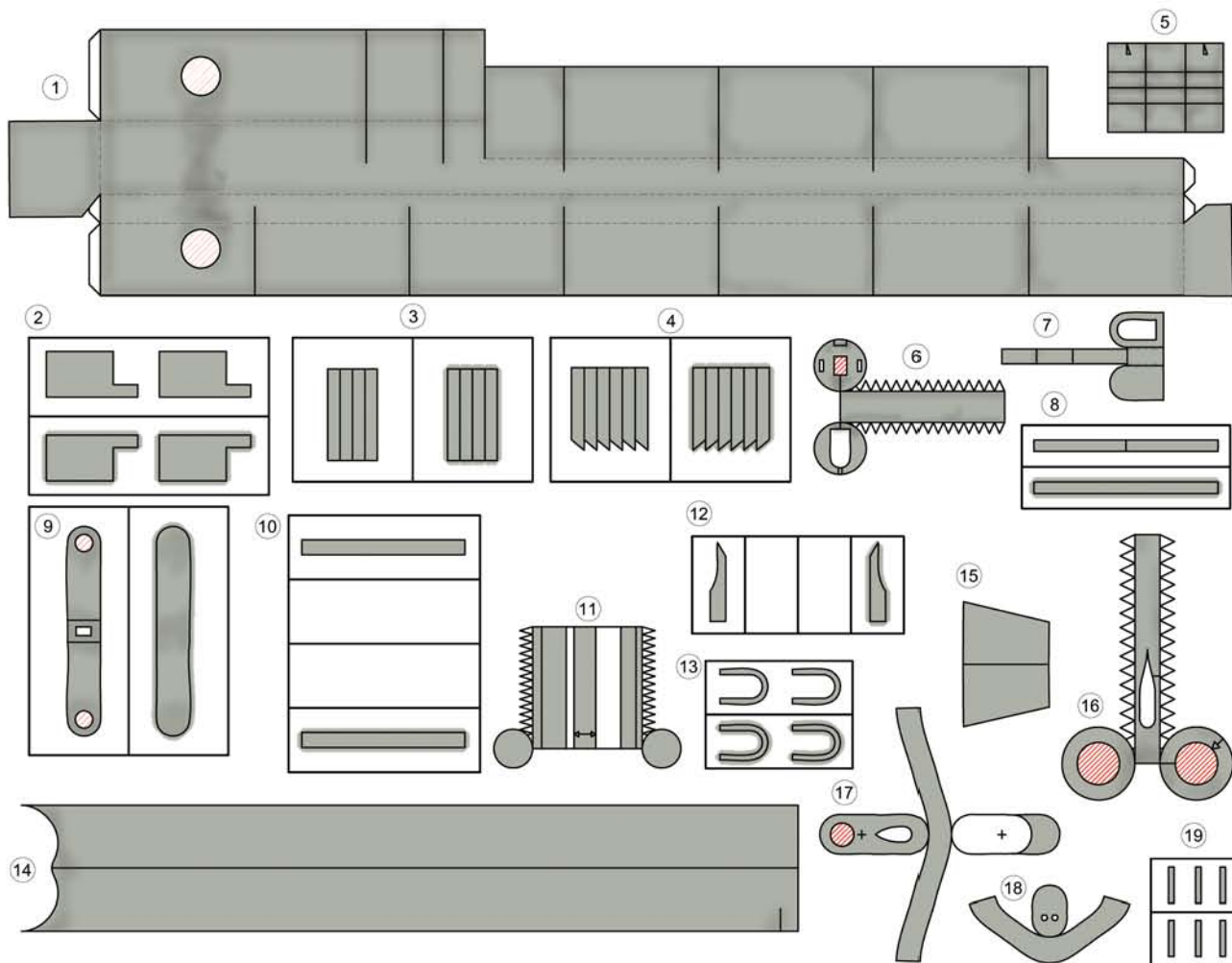



# U-Boat Type VIIC 1/72 Scale

V

190 grams

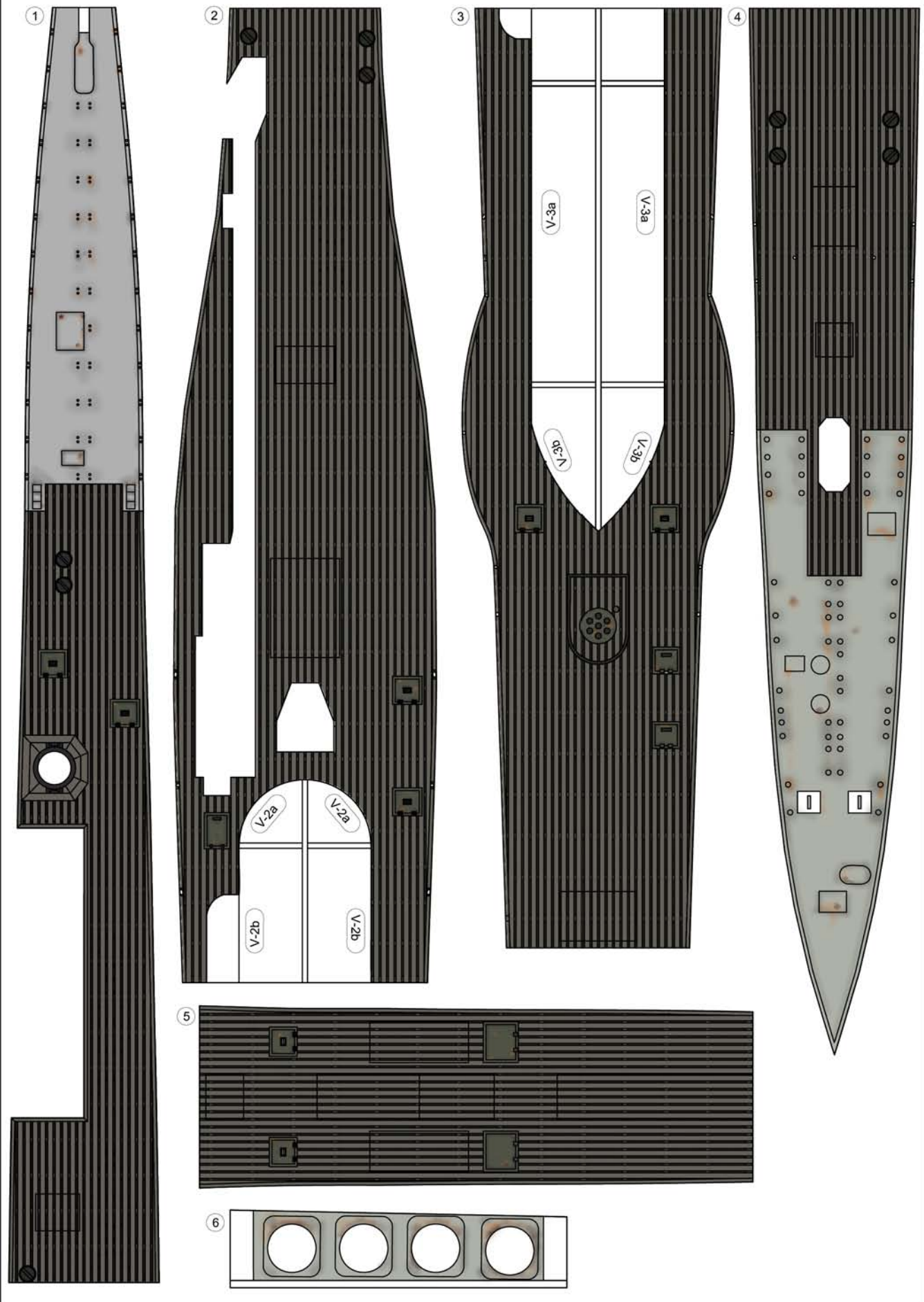

# U-Boat Type VIIC 1/72 Scale

W

70 grms

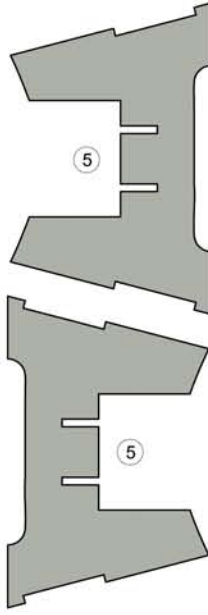
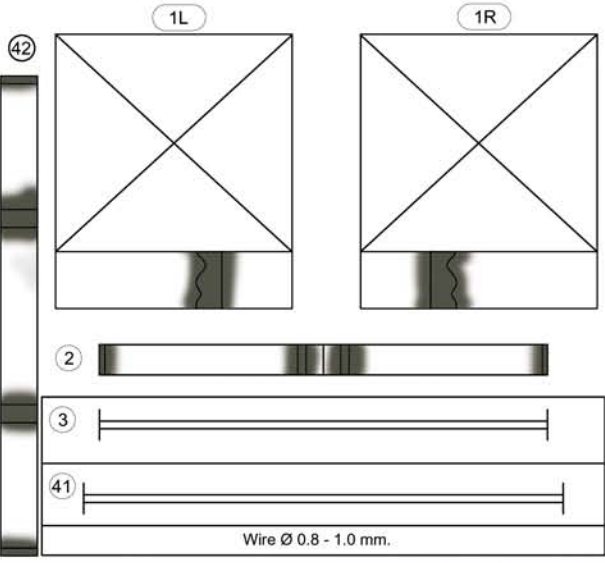

Part No. 4,5,6 and 7 need to be laminated to 1mm card board.



U-Boat Type VII C  
U-Boat Type VII C

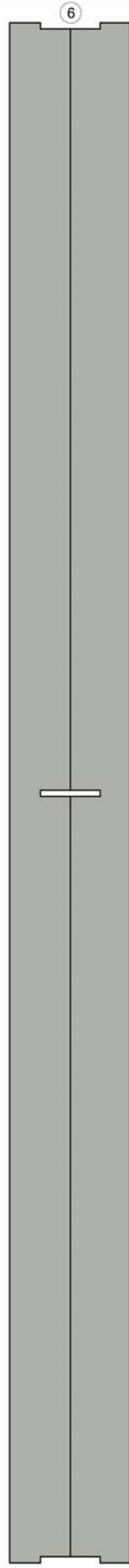
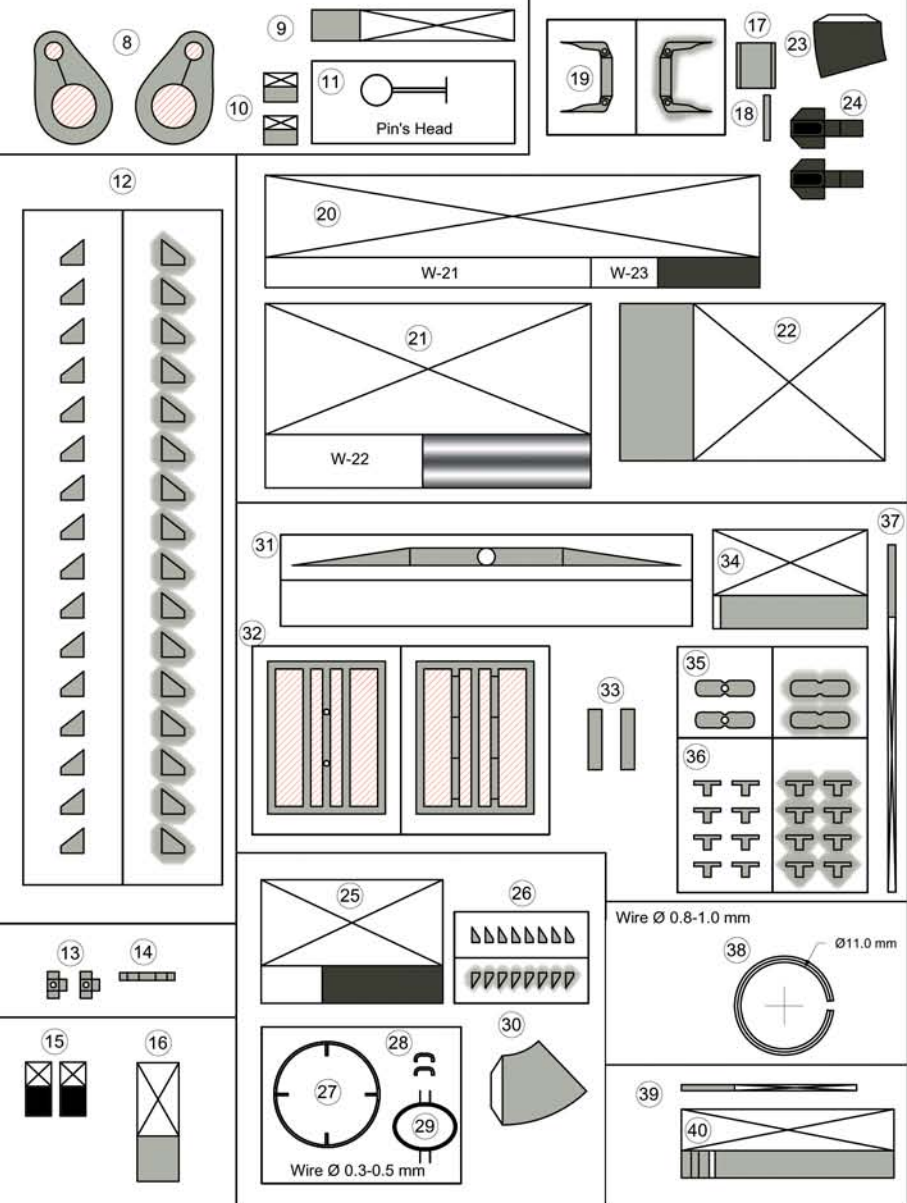

# U-Boat Type VIIC 1/72 Scale

X

90 grms + 1 mm CardBoard

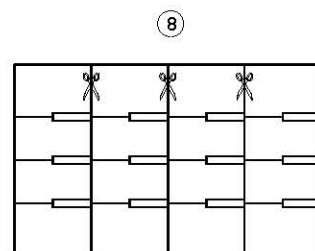
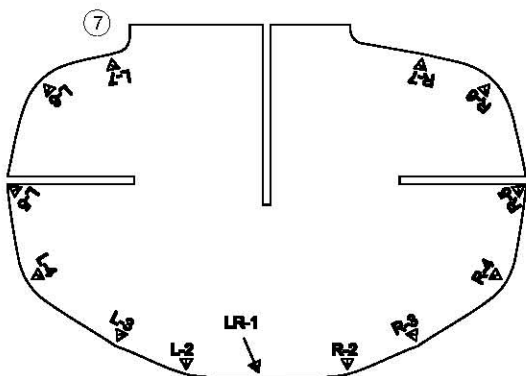
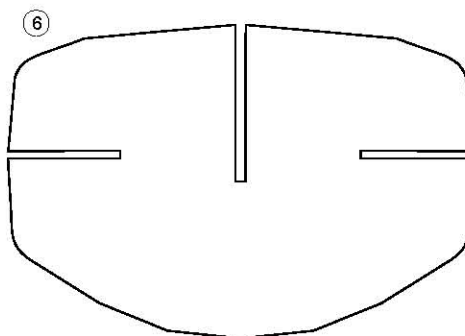
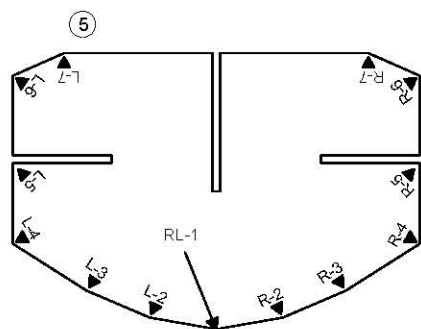
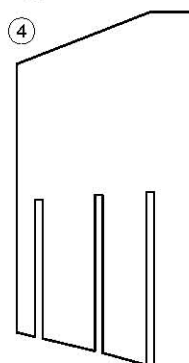
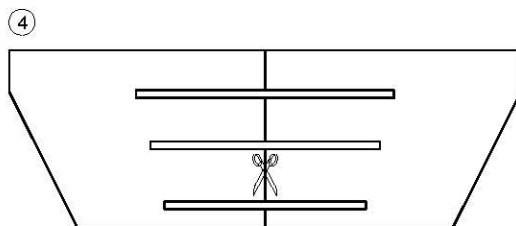
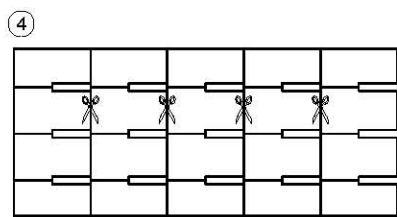
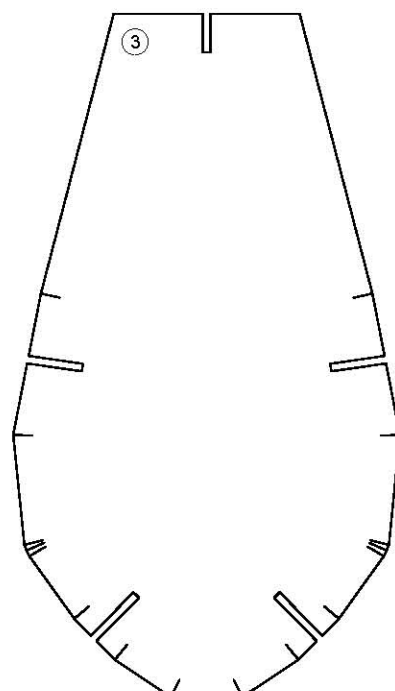
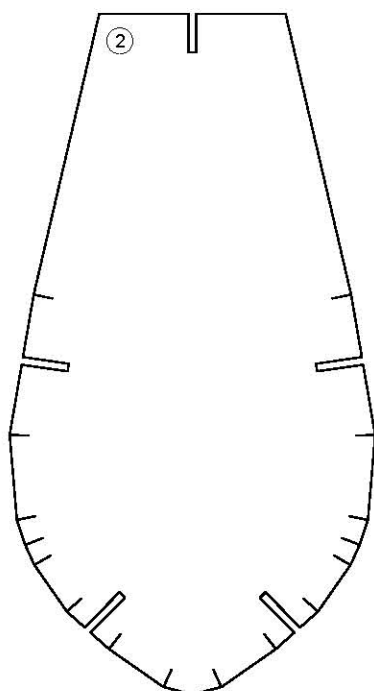
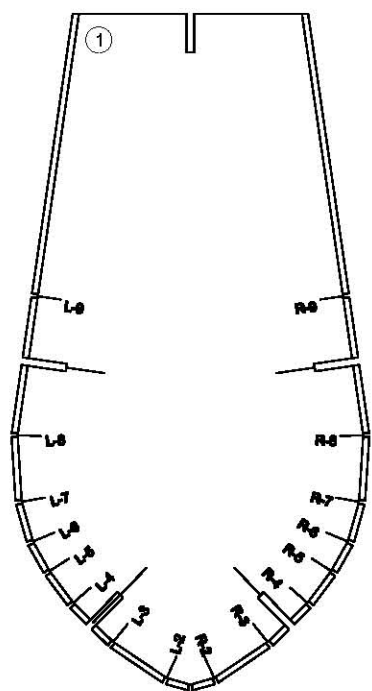

# U-Boat Type VIIC 1/72 Scale

Y

190 grms

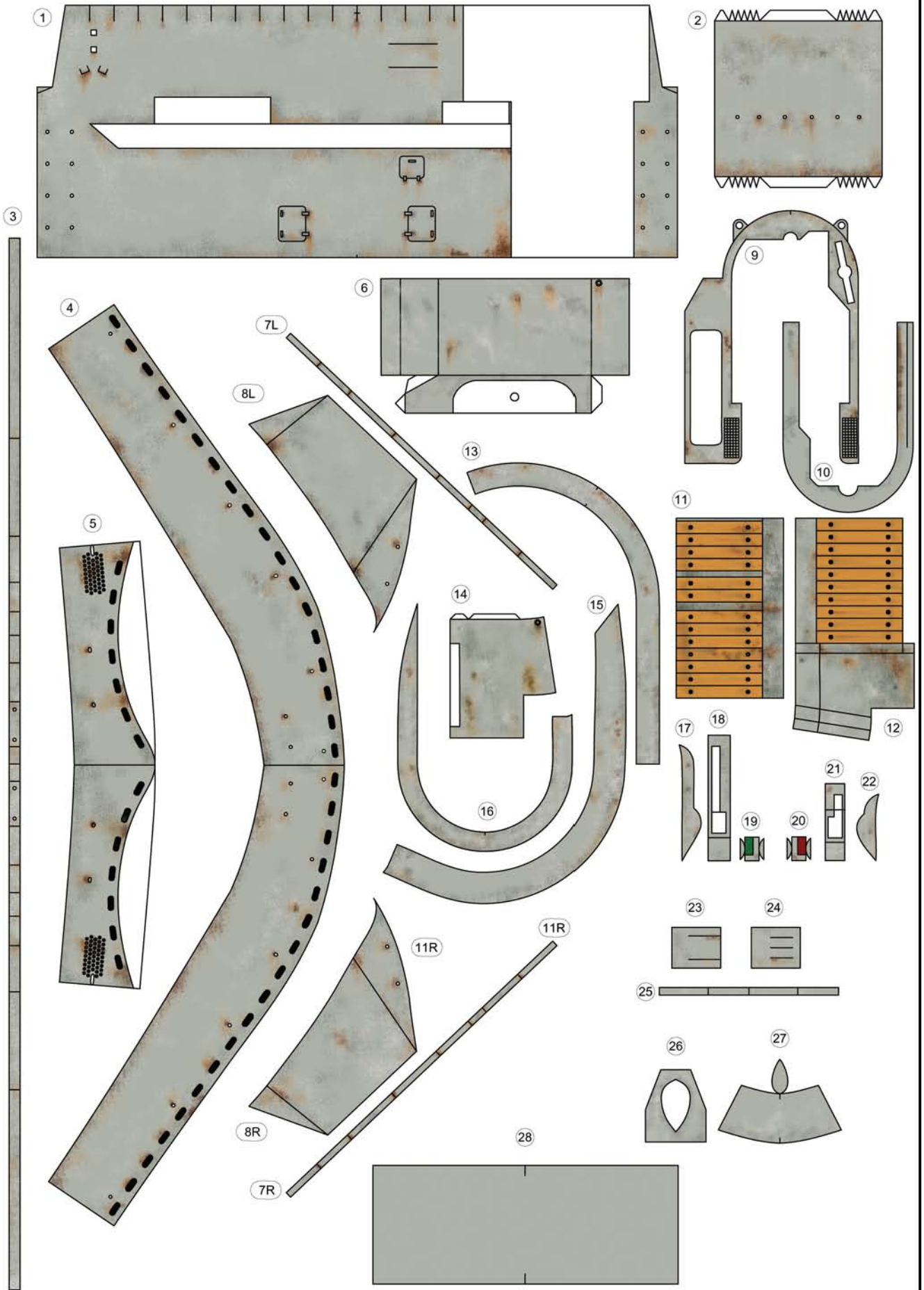

# U-Boat Type VIIC 1/72 Scale

Z

70 grms

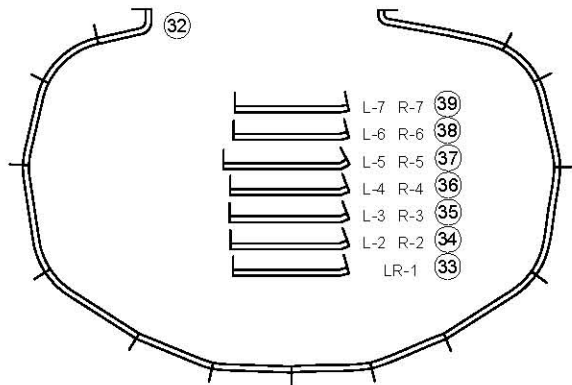
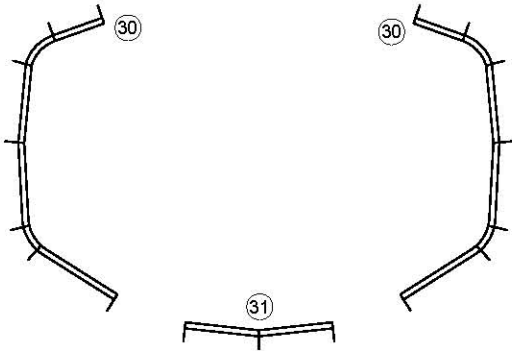
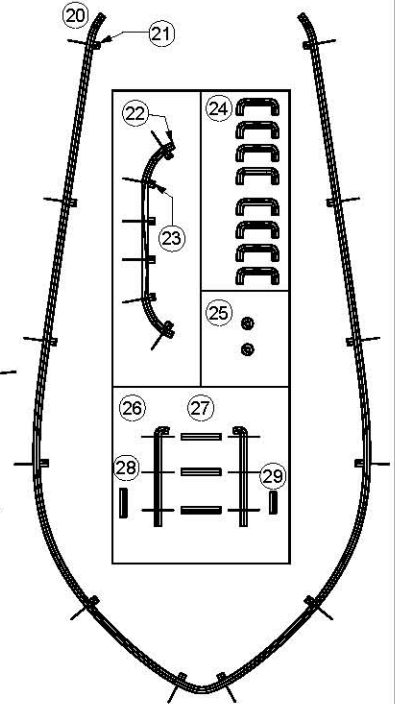
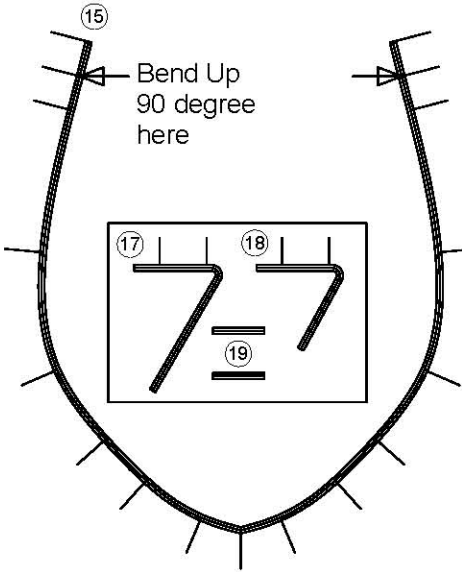
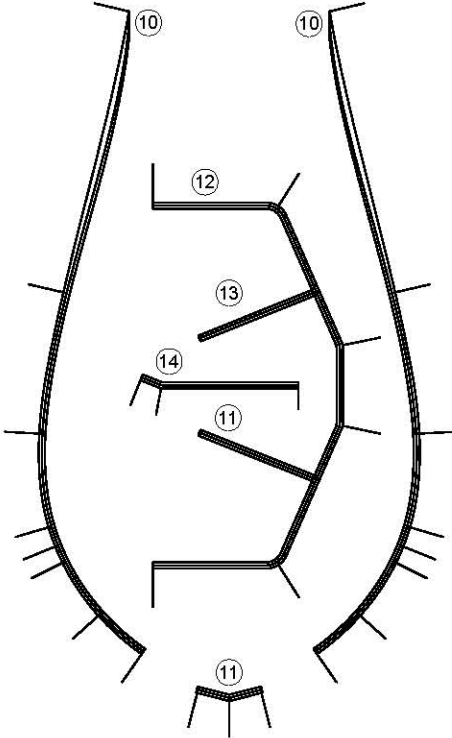
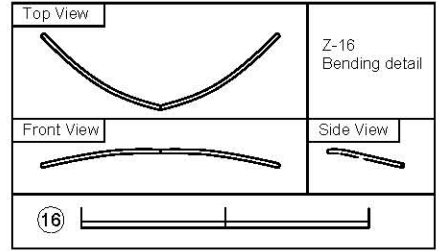
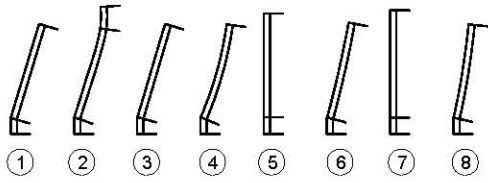

Wire Ø 0.8 - 1.0 mm.



Wire Ø 0.8 - 1.0 mm.



Wire Ø 0.8 - 1.0 mm.



Wire Ø 0.3 - 0.5 mm.

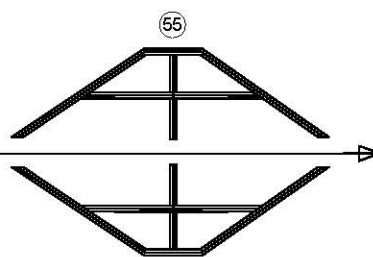
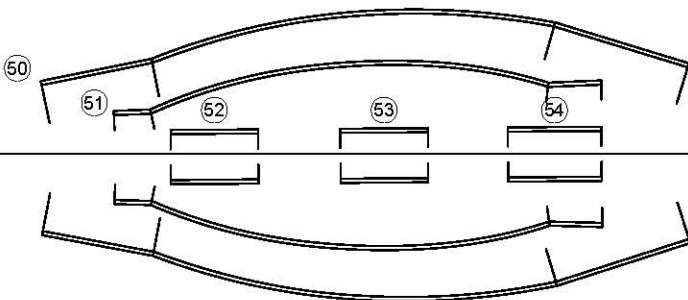

Wire Ø 0.8 - 1.0 mm.

How to make Z-44 and Z-45

