

PAPER CRAFT

<http://www.canon.com/c-park/en/>

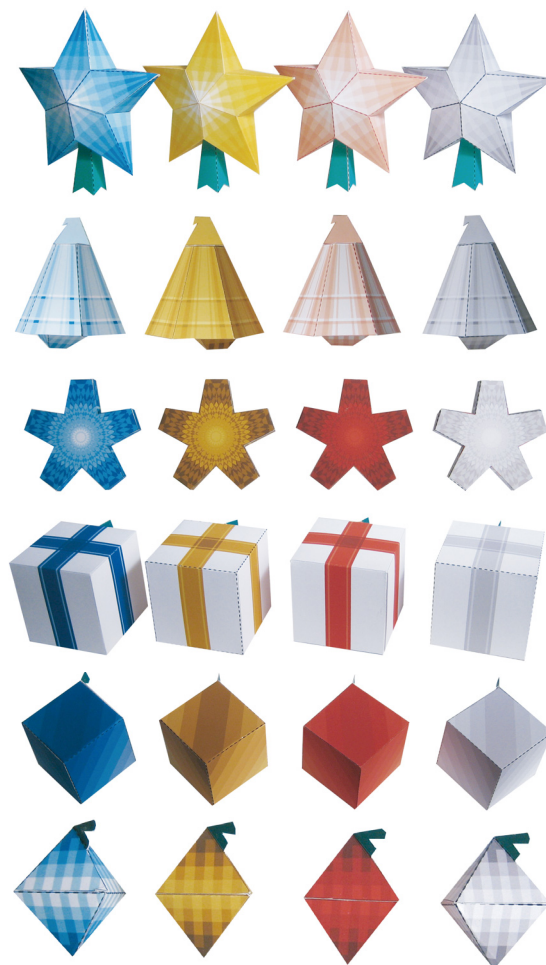

View of completed model
(Decorated tree)



View of completed model
(The ornaments)

Ornaments are provided in six types of four colors each. Build as many of the ornaments you like in your favorite colors to decorate your tree.

Christmas tree with ornaments (the ornaments)

The tradition of decorating Christmas trees in a ceremony to protect against evil and to offer up prayers is said to have originated in Germany. Scholars believe the Christmas tree fuses aspects of Christianity with the German pre-Christian tradition of decorating evergreen conifers (especially *Picea abies* and fir trees) - which symbolize vitality - for the winter solstice and the New Year. Topped with a gleaming star heralding Christ's birth and with branches decorated with gold and silver lacing and cotton snow and lit with candles and light bulbs, Christmas trees add to the romance of Christmas Eve. Decorate this tree in whatever way appeals to you - simply insert the hooks of Christmas tree ornaments into the openings on the leaves. You can even use ornaments other than the ones included in this kit.

■ Parts list (pattern): Twenty three US letter sheets (No.1 to No.23)

■ No. of Parts: 172

* Build the model by carefully reading the Assembly Instructions, in the parts sheet page order.

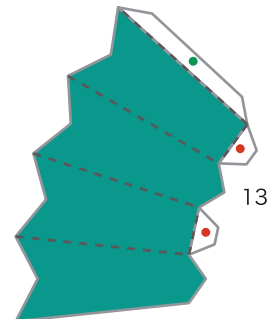
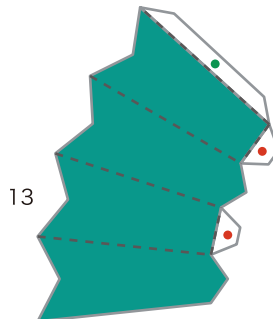
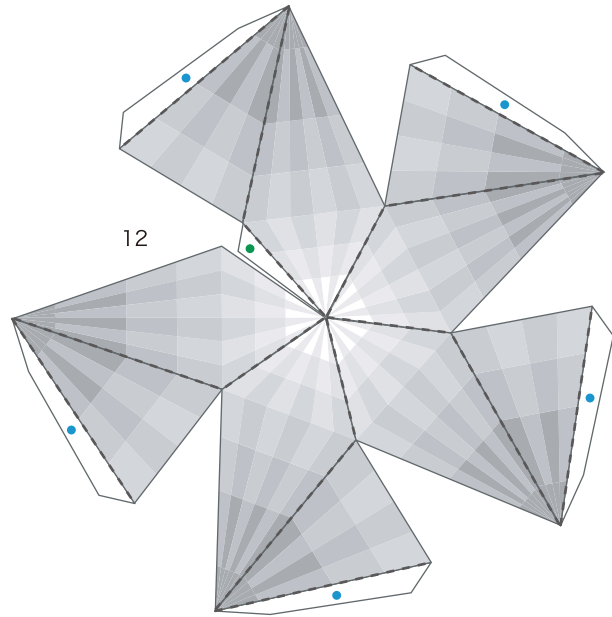
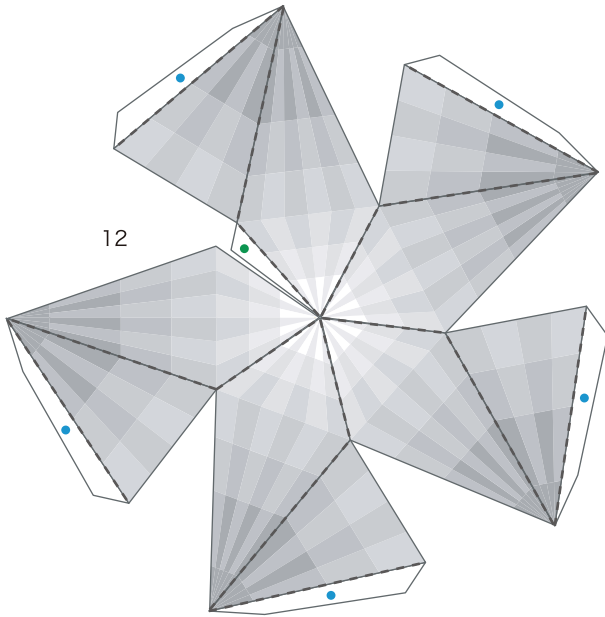
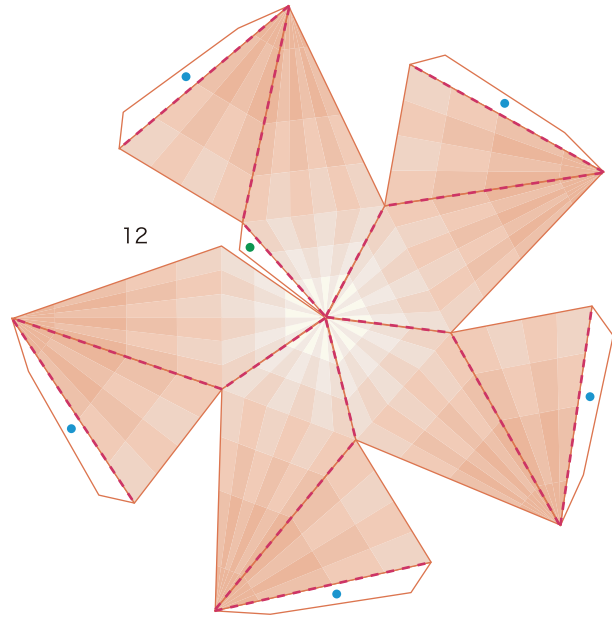
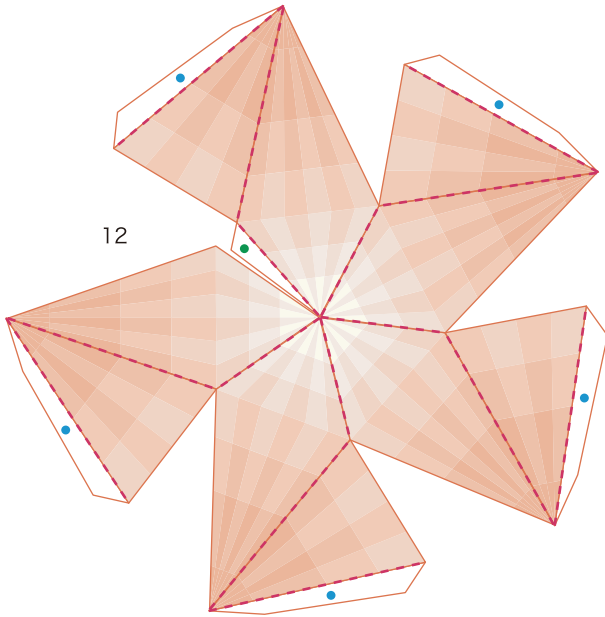

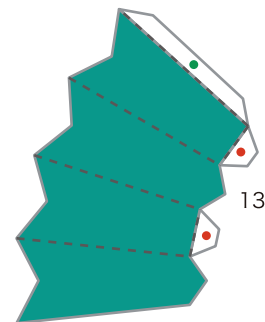
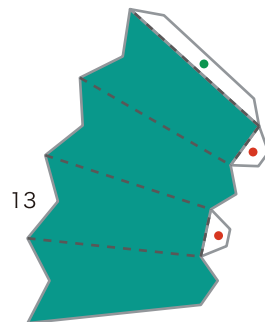
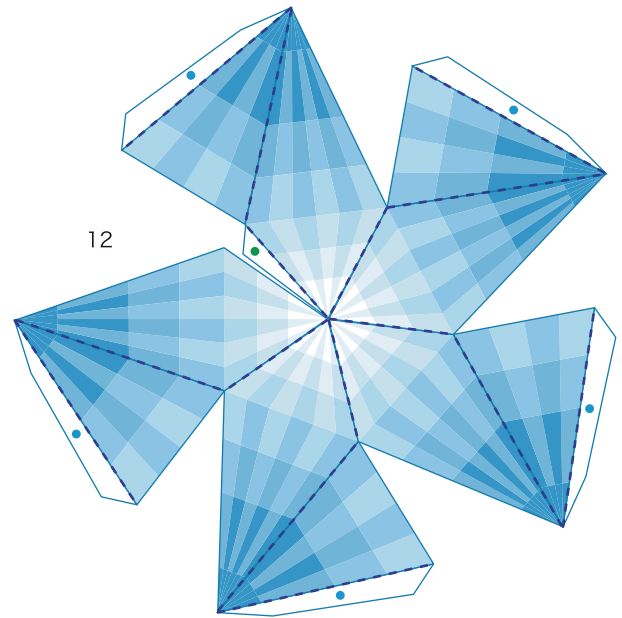
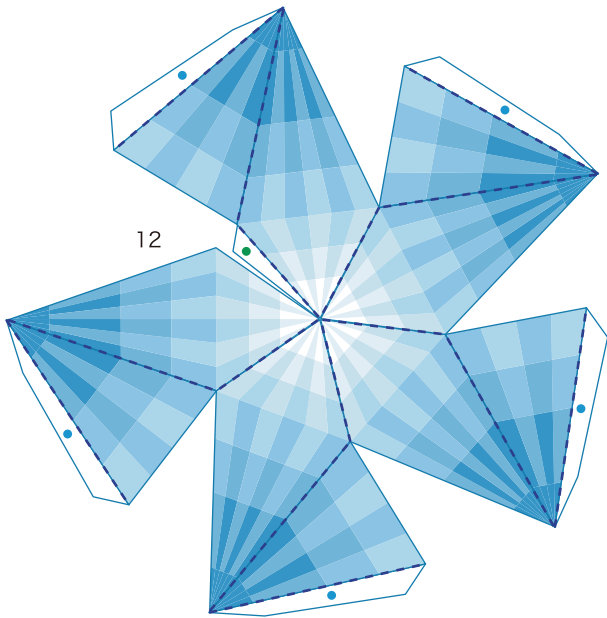
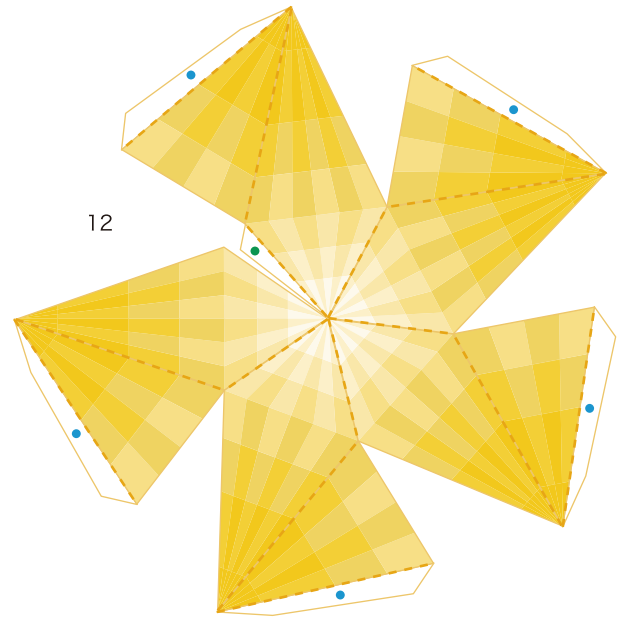
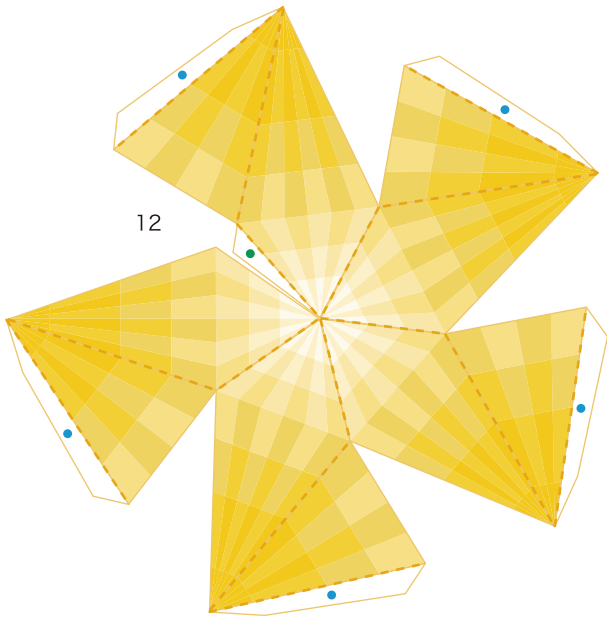

Christmas tree with ornaments (the ornaments): Pattern

© Canon Inc. © T. Ichiyama

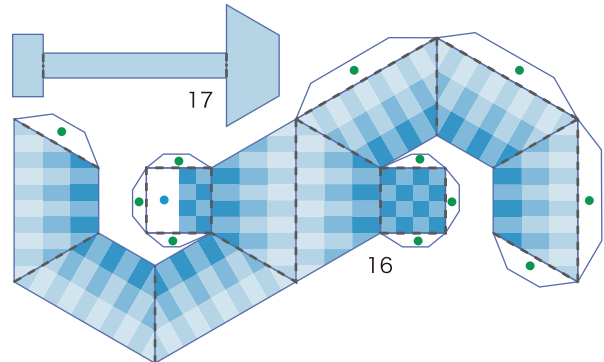
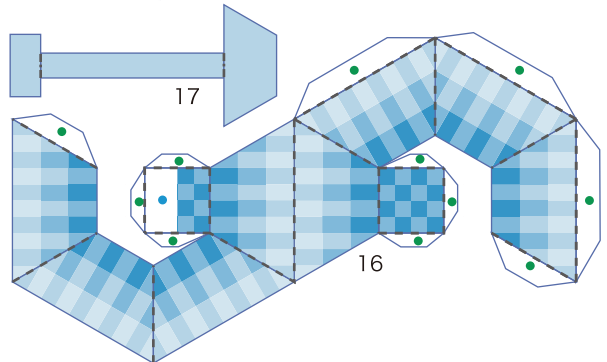
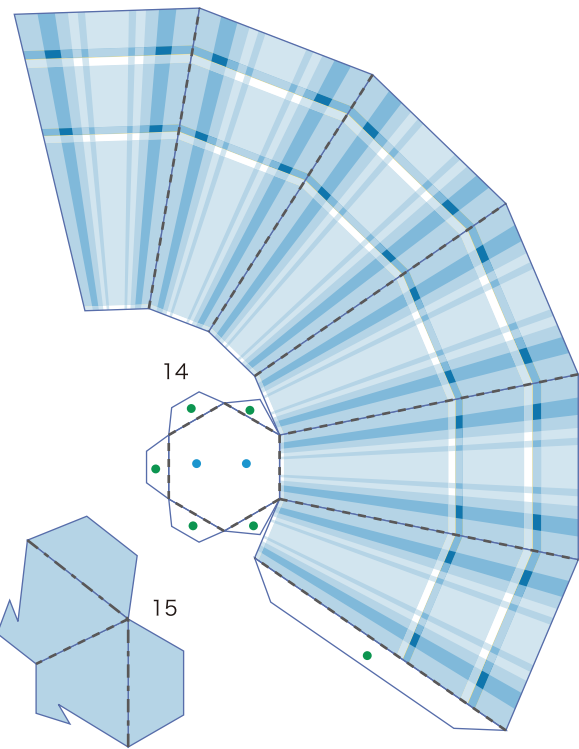
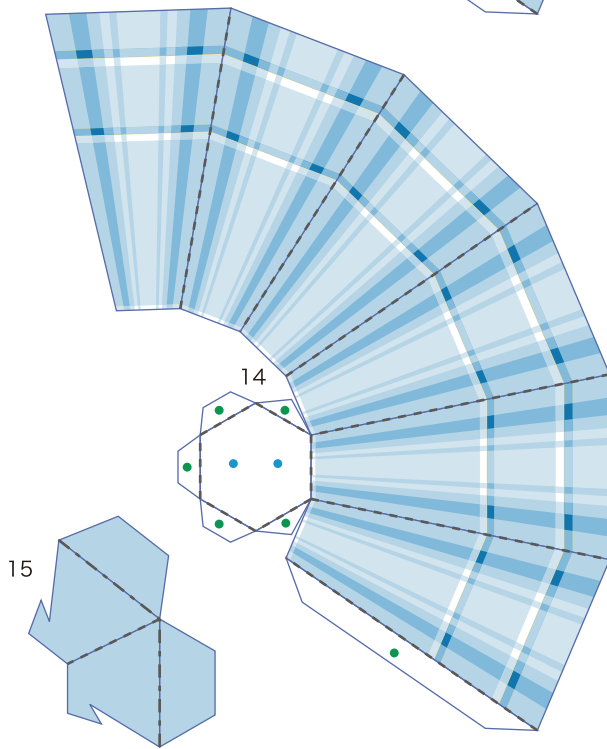
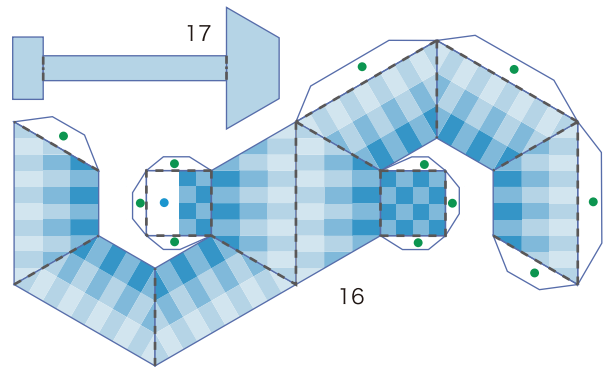
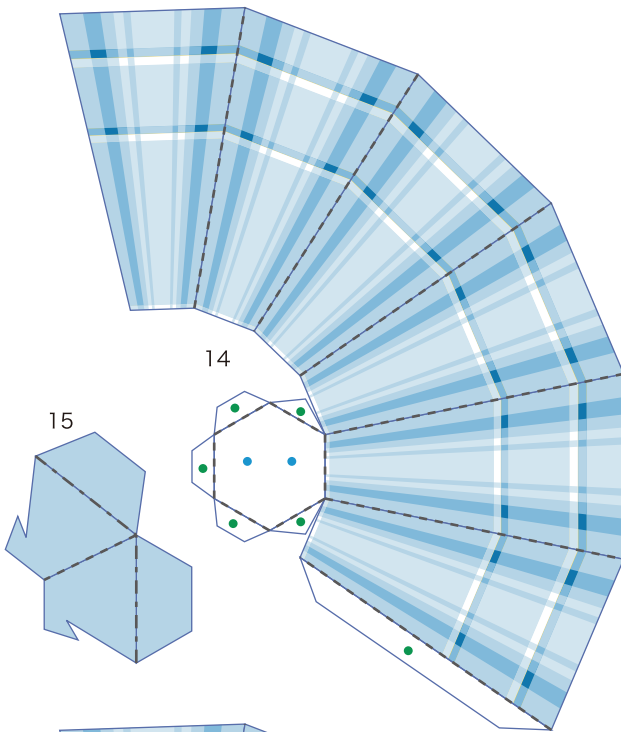

Christmas tree with ornaments (the ornaments): Pattern

© Canon Inc. © T. Ichiyama

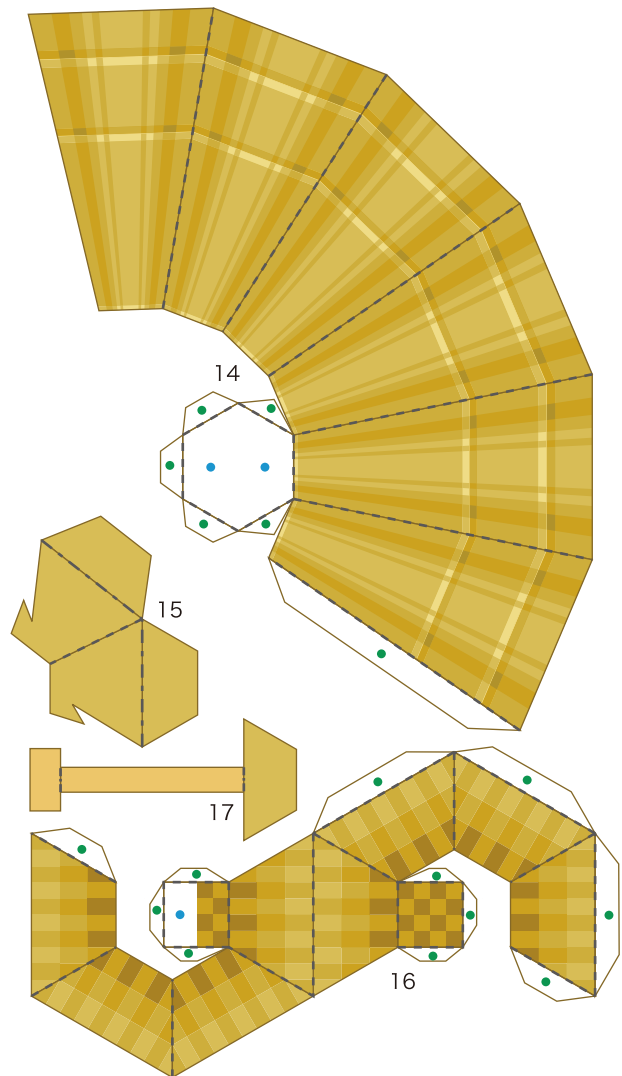
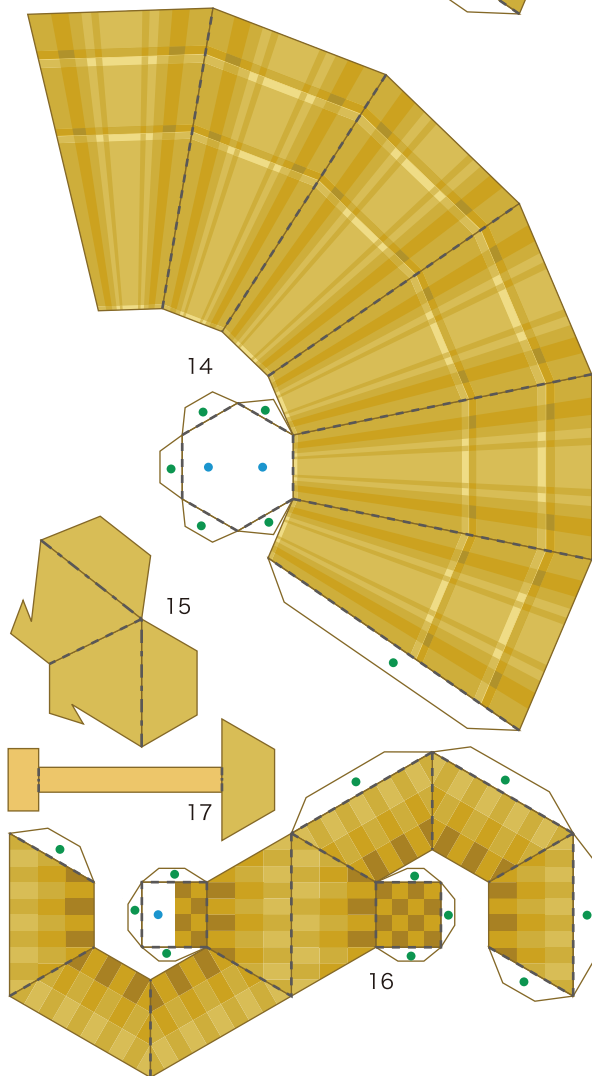
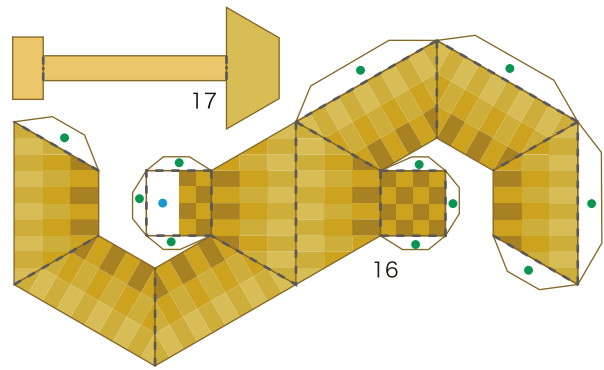
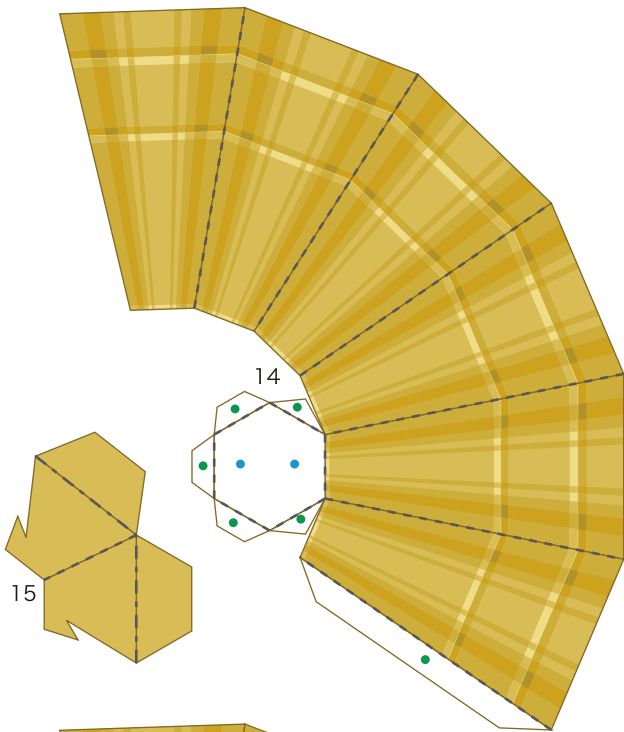

© Canon Inc. © T. Ichiyama

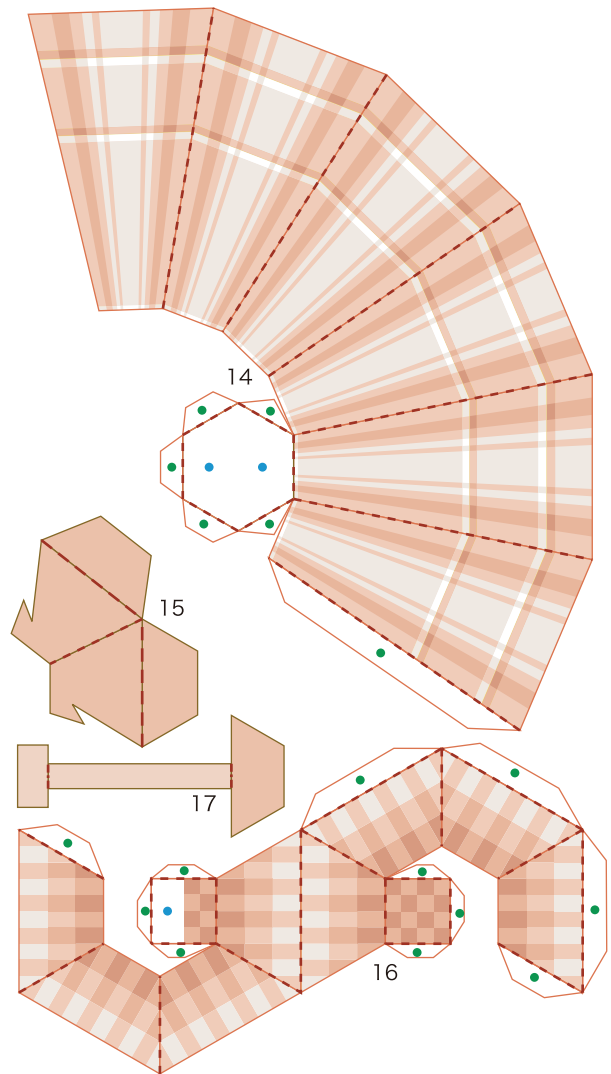
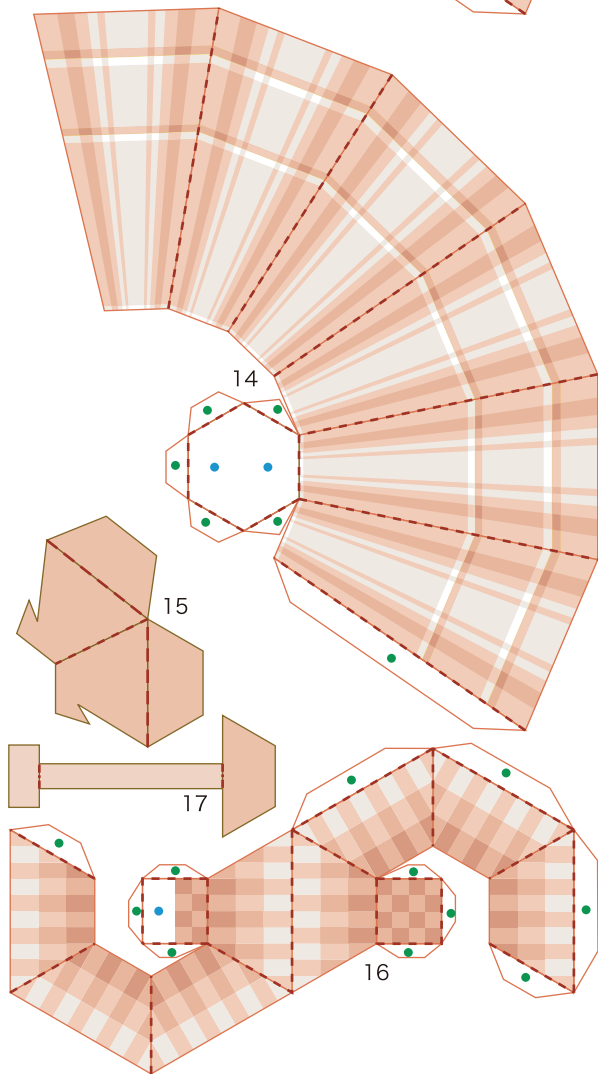
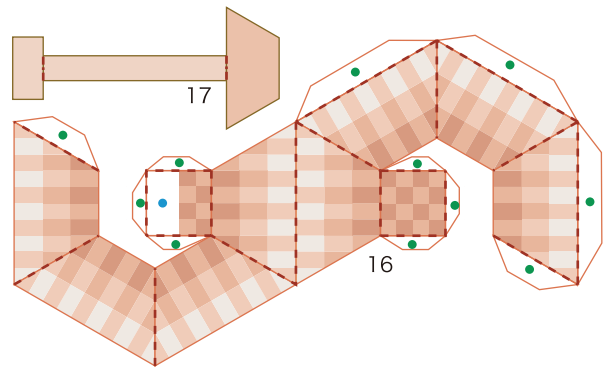
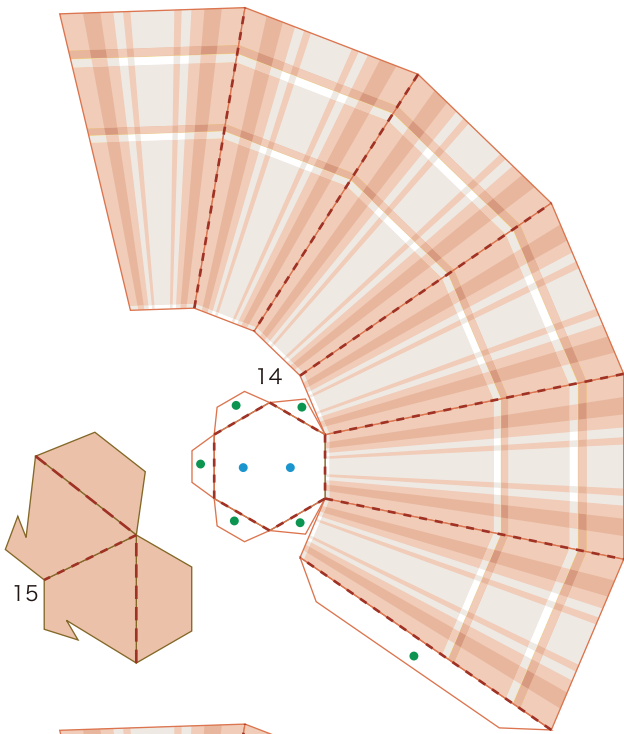

Christmas tree with ornaments (the ornaments): Pattern

© Canon Inc. © T. Ichiyama

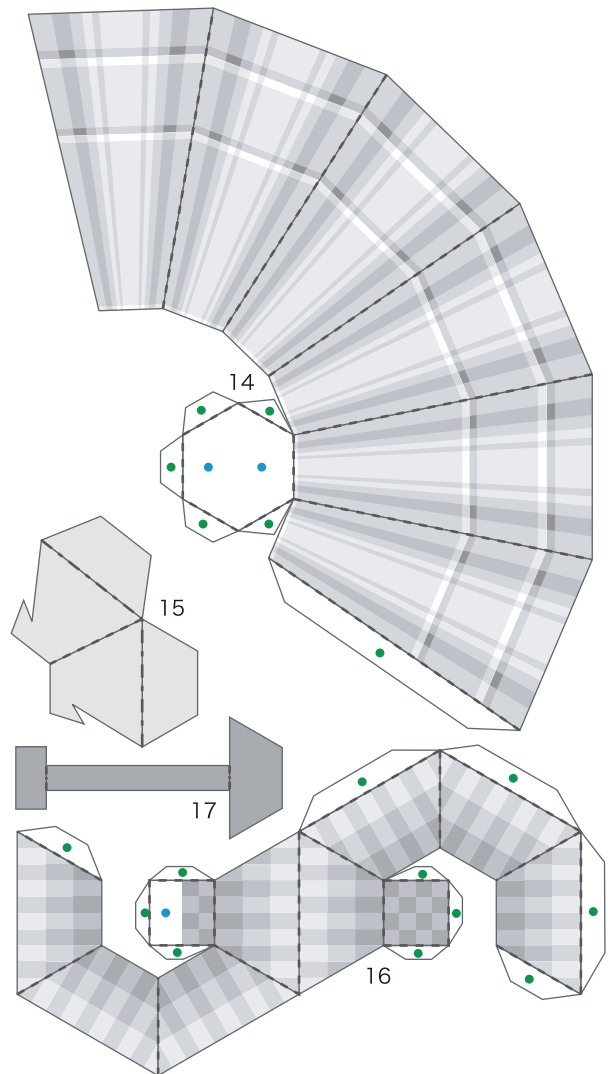
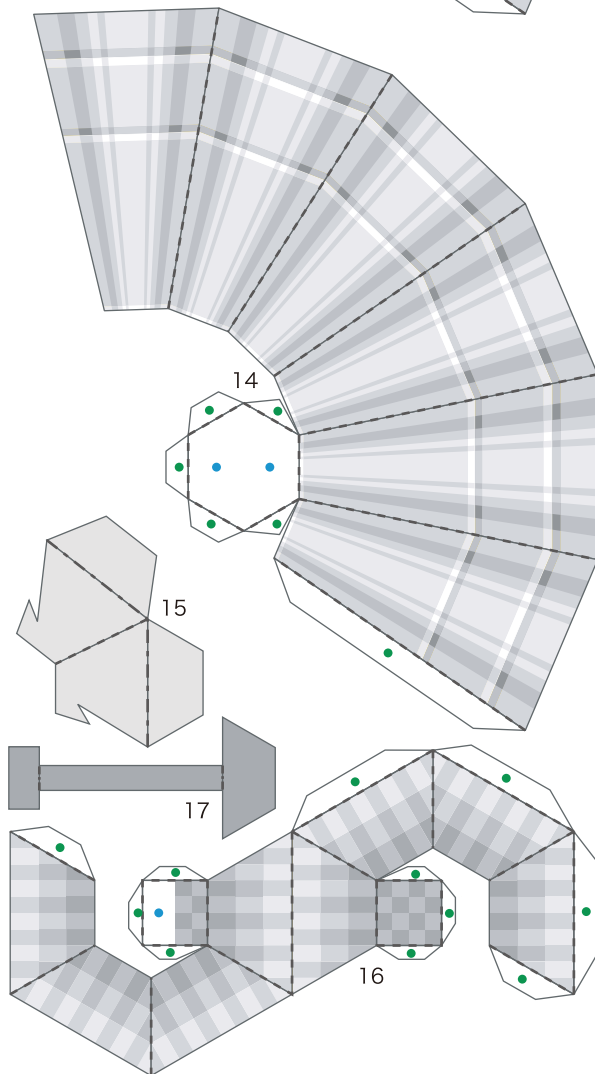
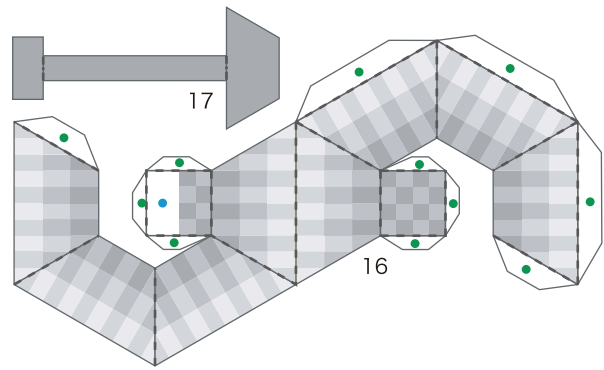
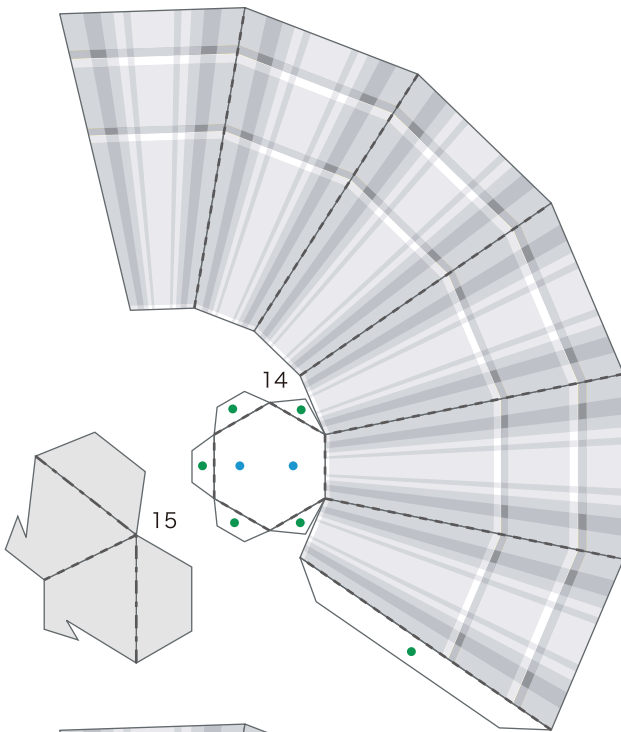

Christmas tree with ornaments (the ornaments): Pattern

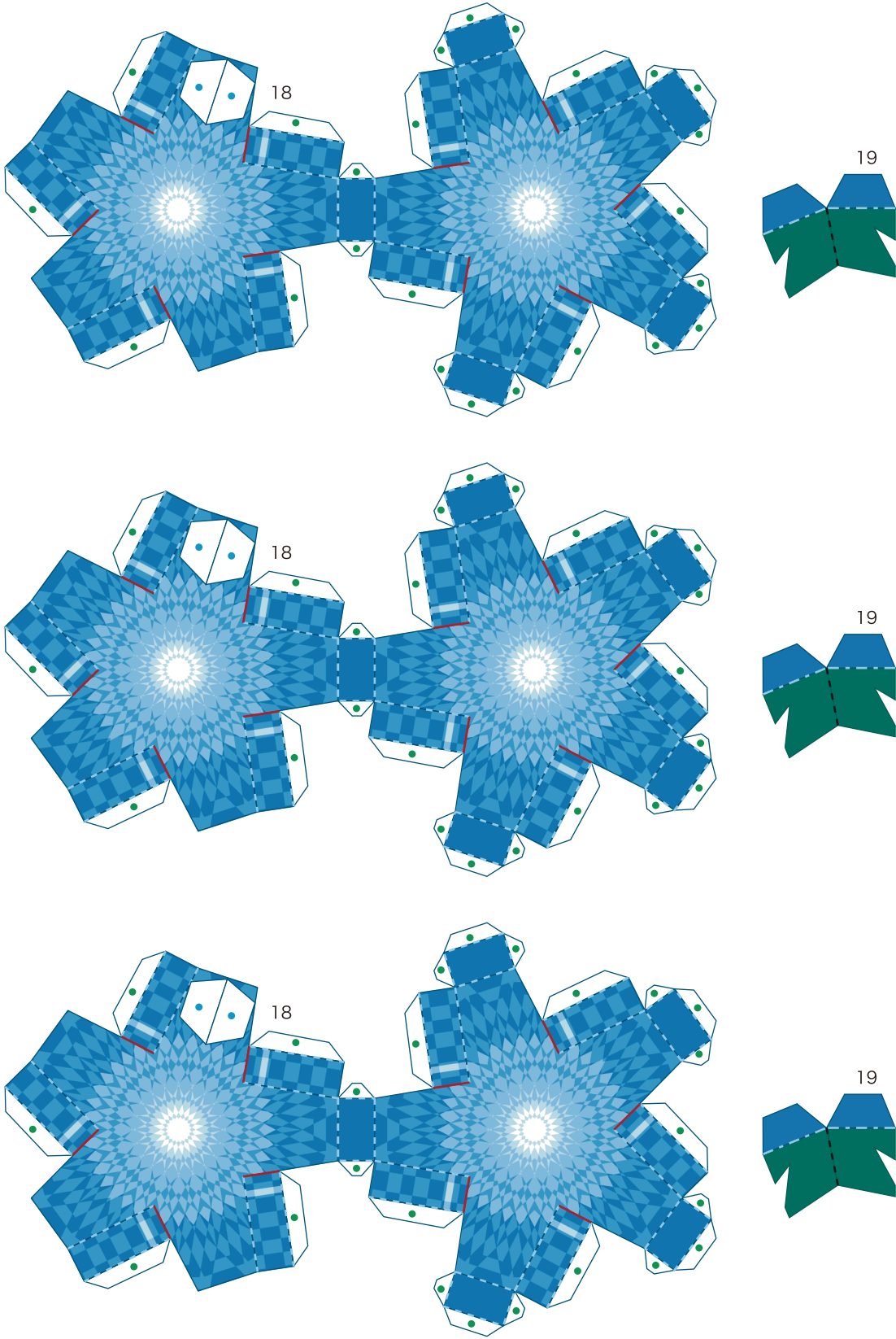

Christmas tree with ornaments (the ornaments): Pattern

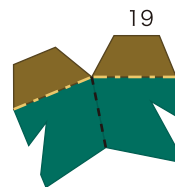
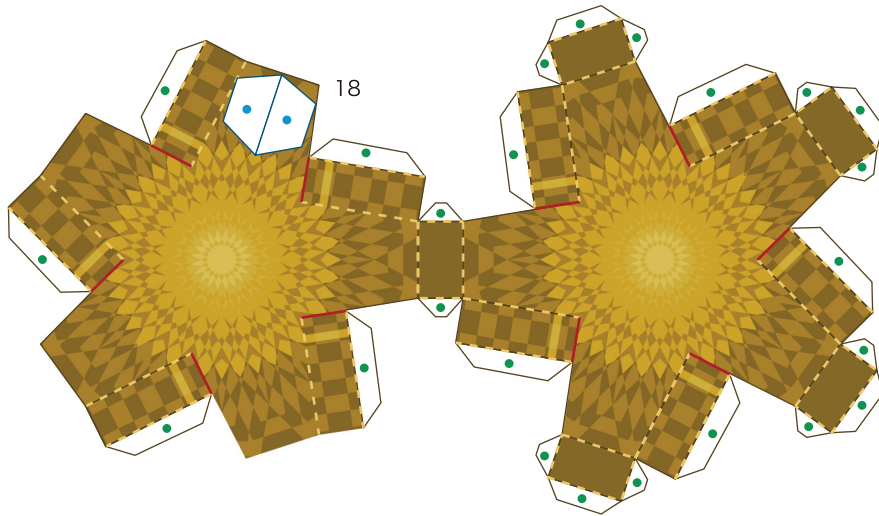
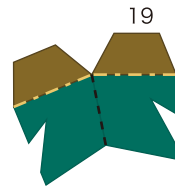
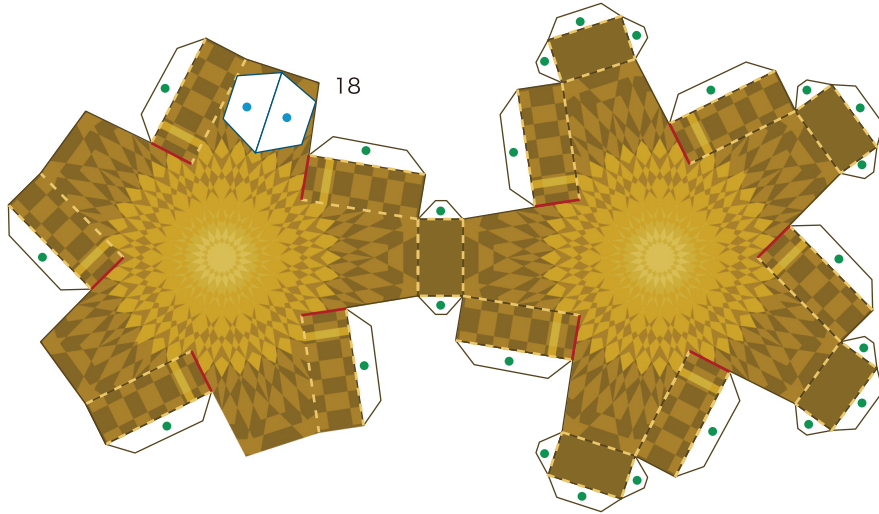
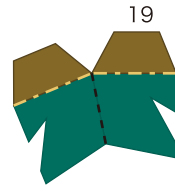
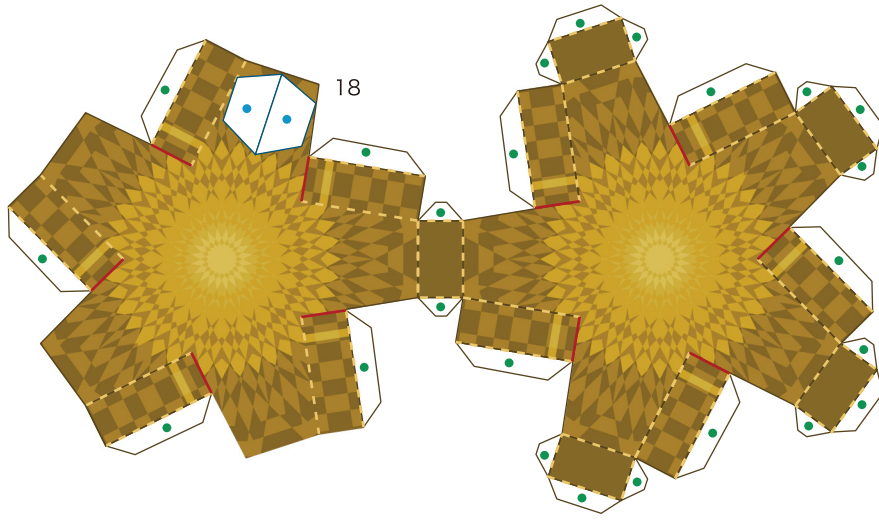

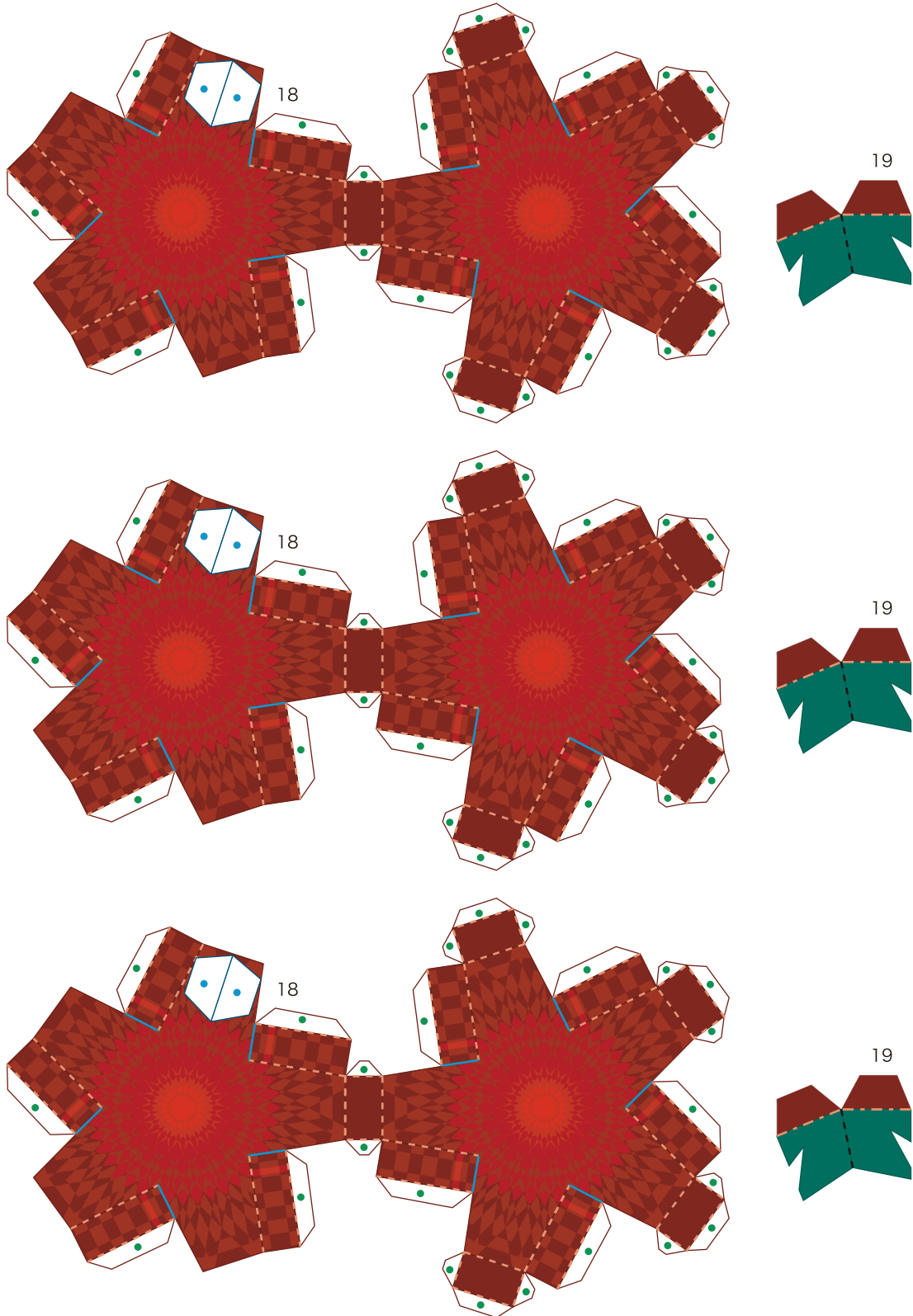

Christmas tree with ornaments (the ornaments): Pattern

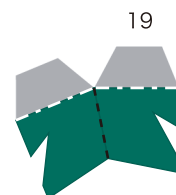
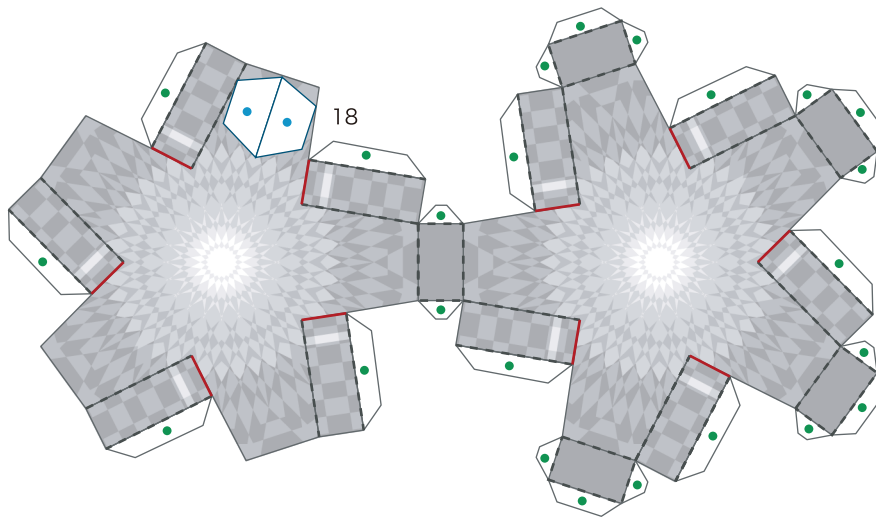
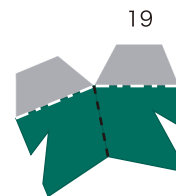
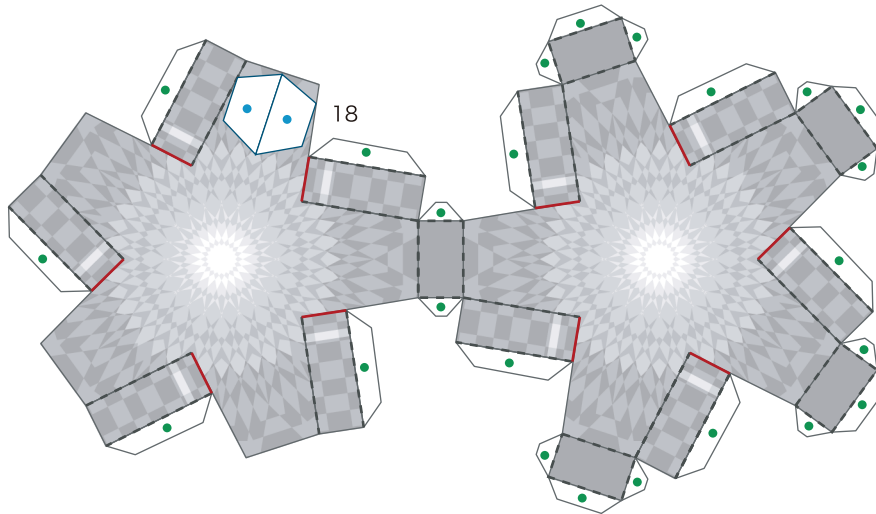
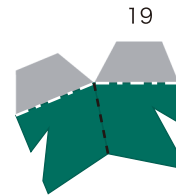
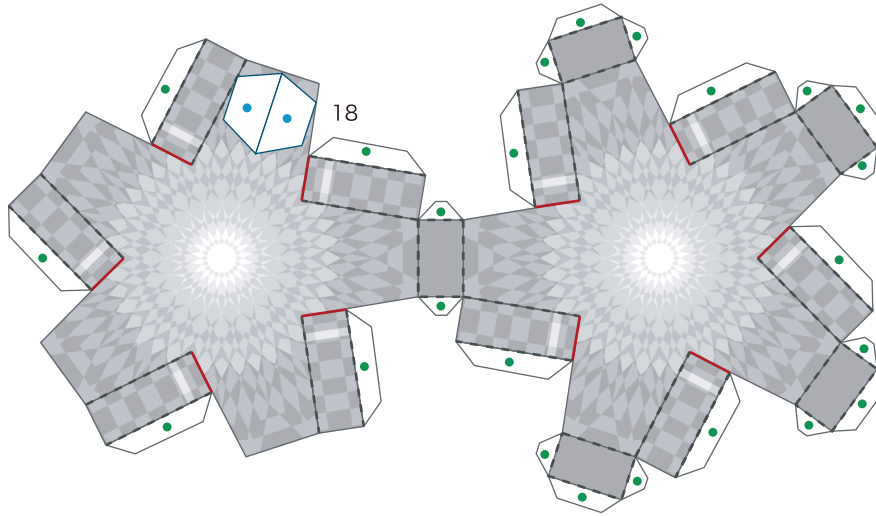

Christmas tree with ornaments (the ornaments): Pattern

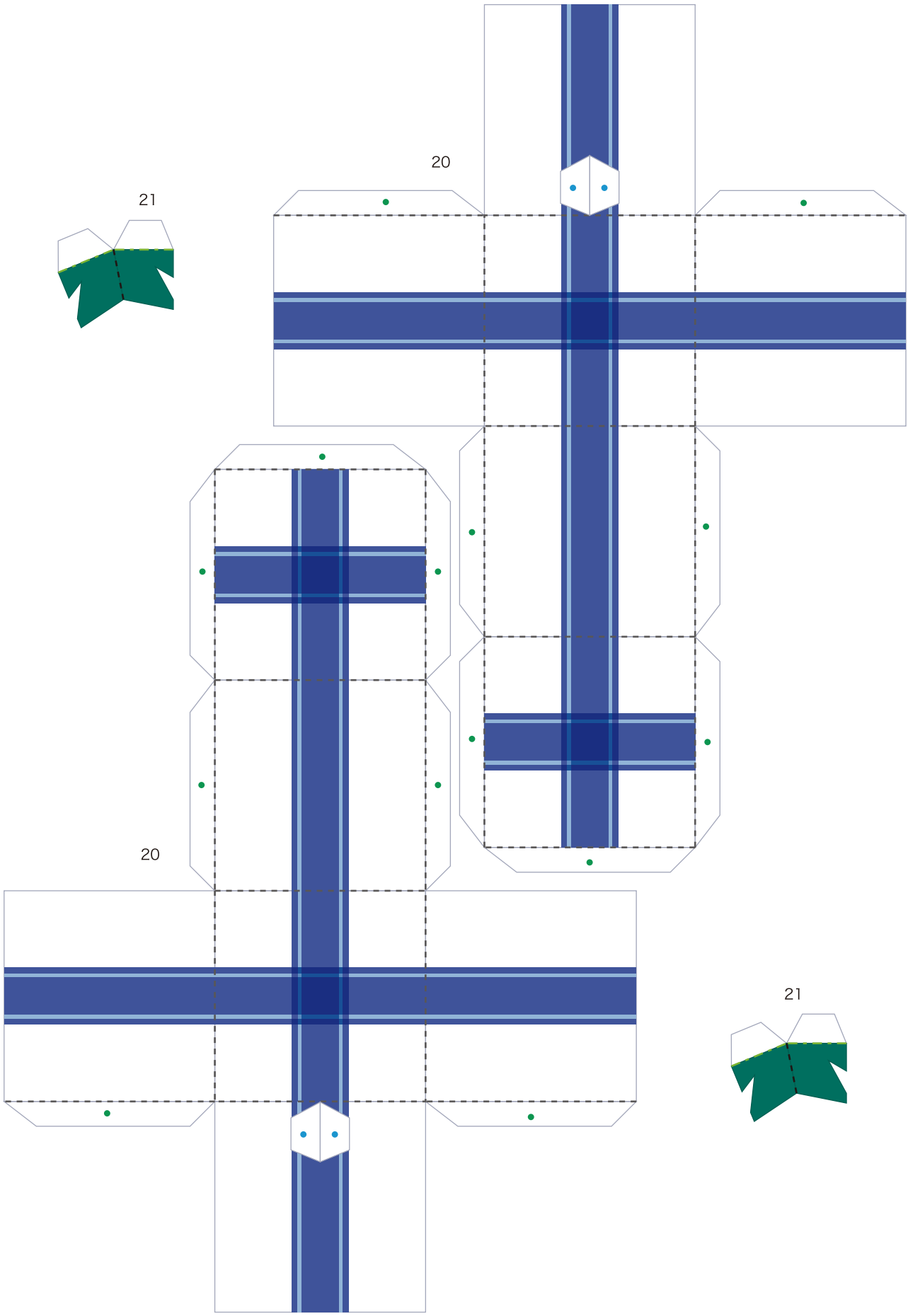

Christmas tree with ornaments (the ornaments): Pattern

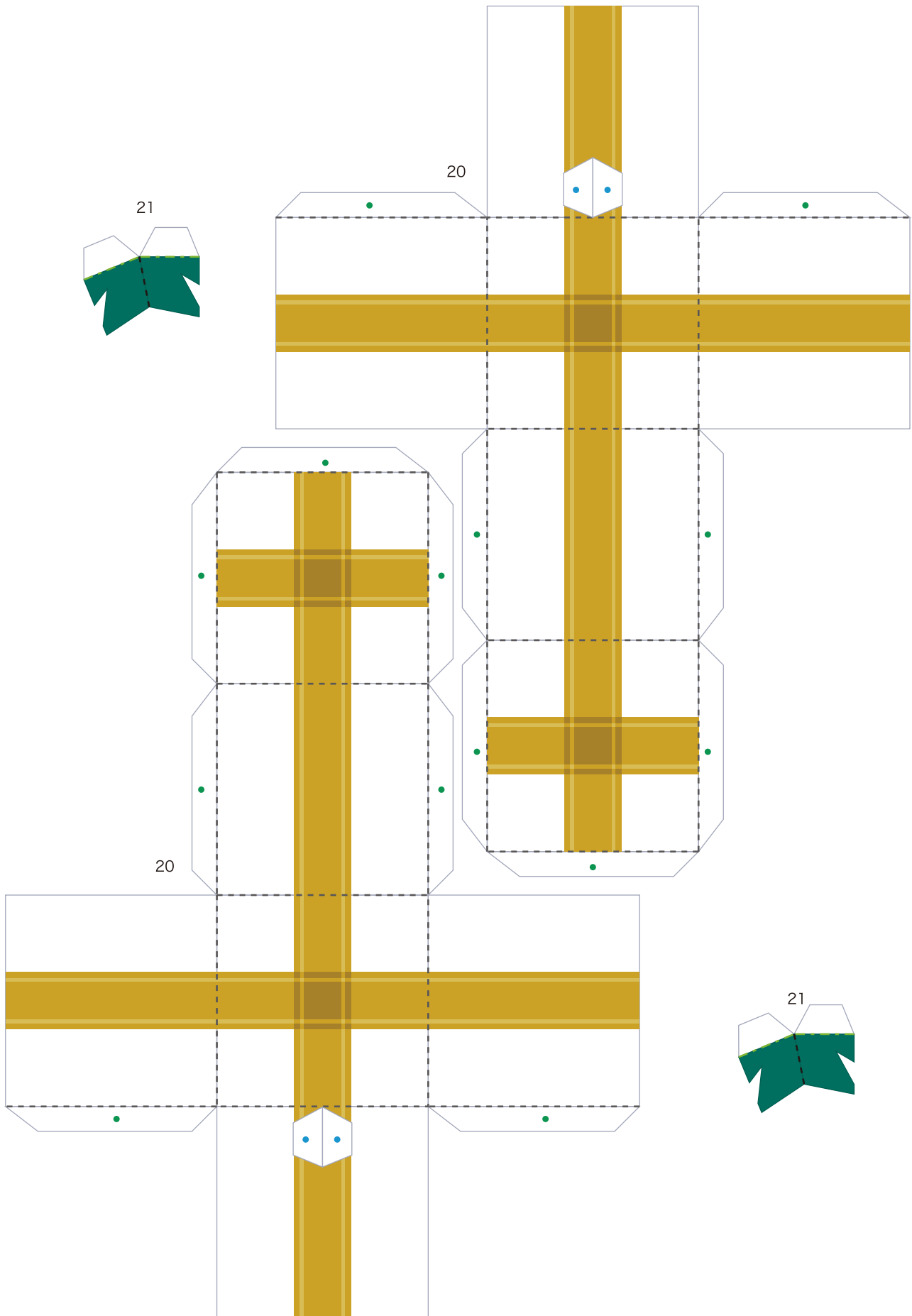

Christmas tree with ornaments (the ornaments): Pattern

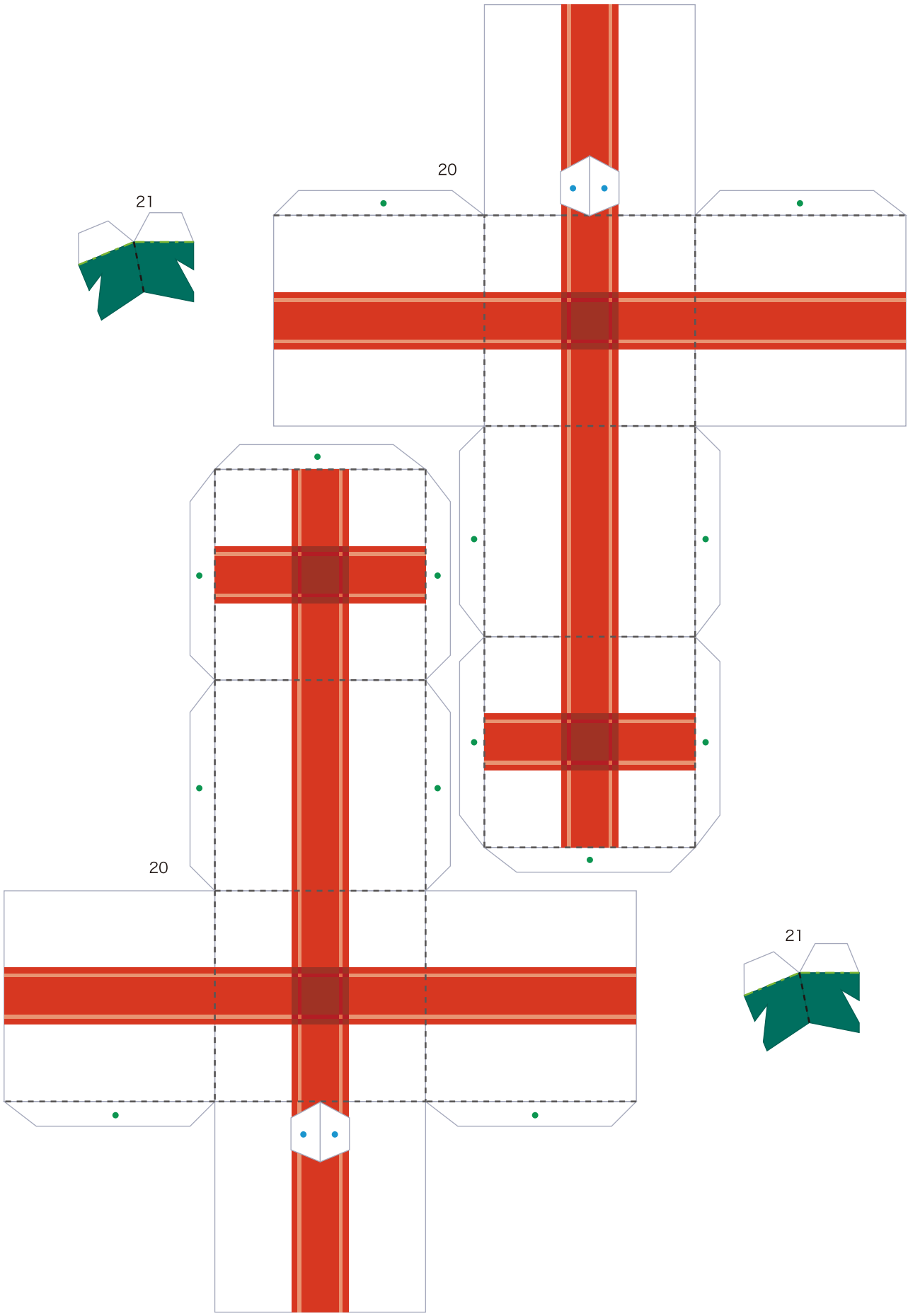

Christmas tree with ornaments (the ornaments): Pattern

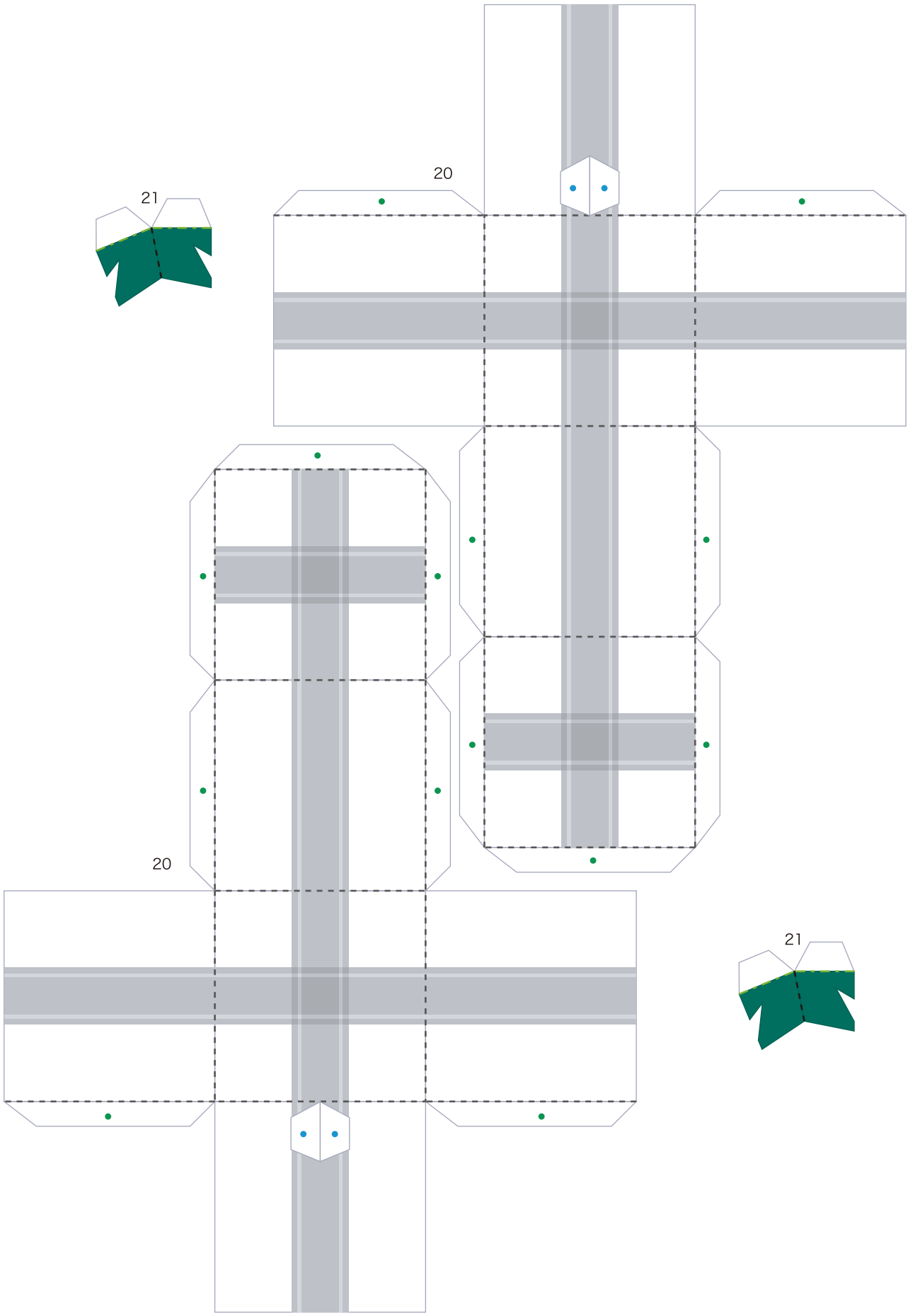

Christmas tree with ornaments (the ornaments): Pattern

© Canon Inc. © T. Ichiyama

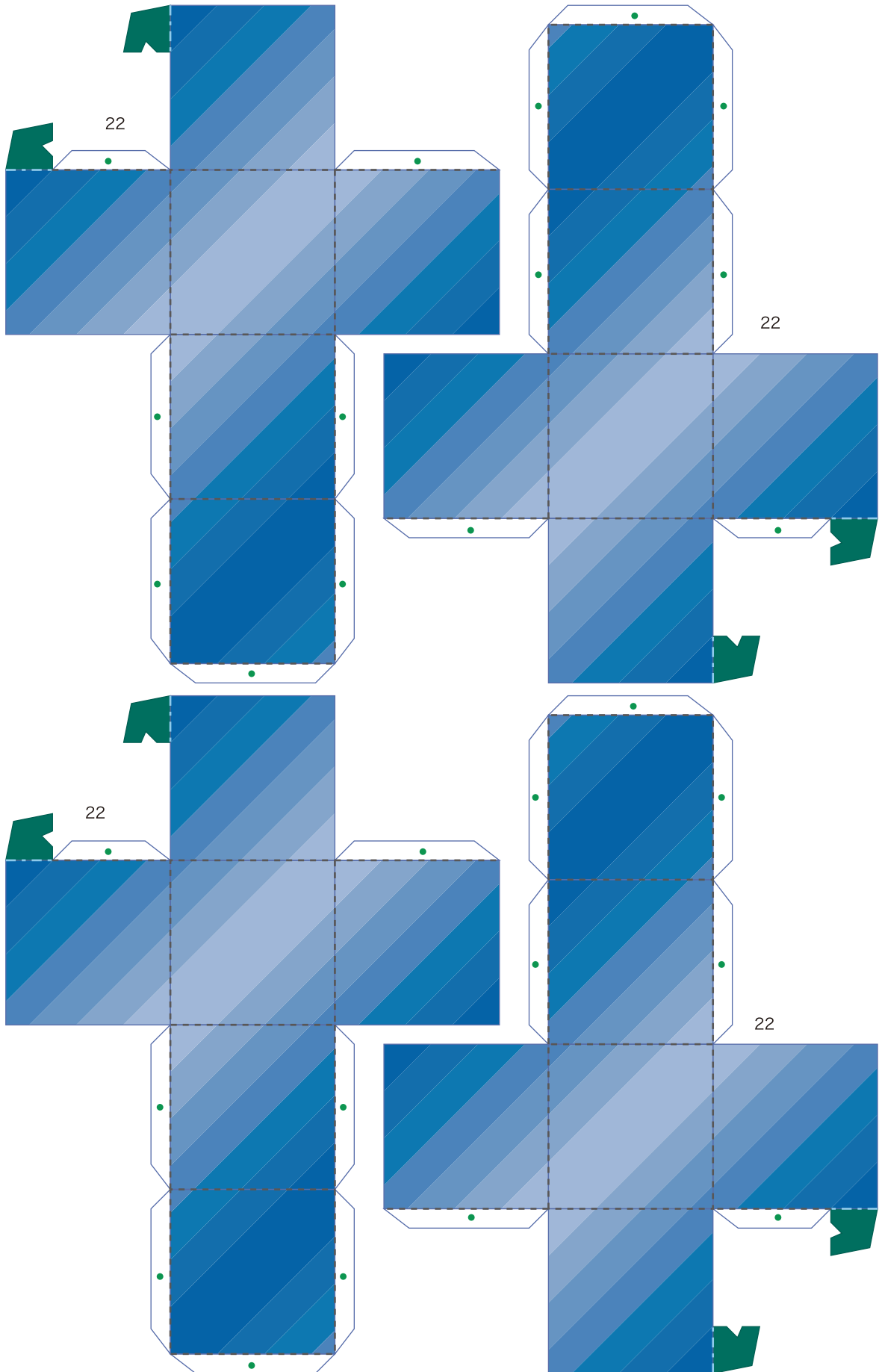

Christmas tree with ornaments (the ornaments): Pattern

© Canon Inc. © T. Ichiyama

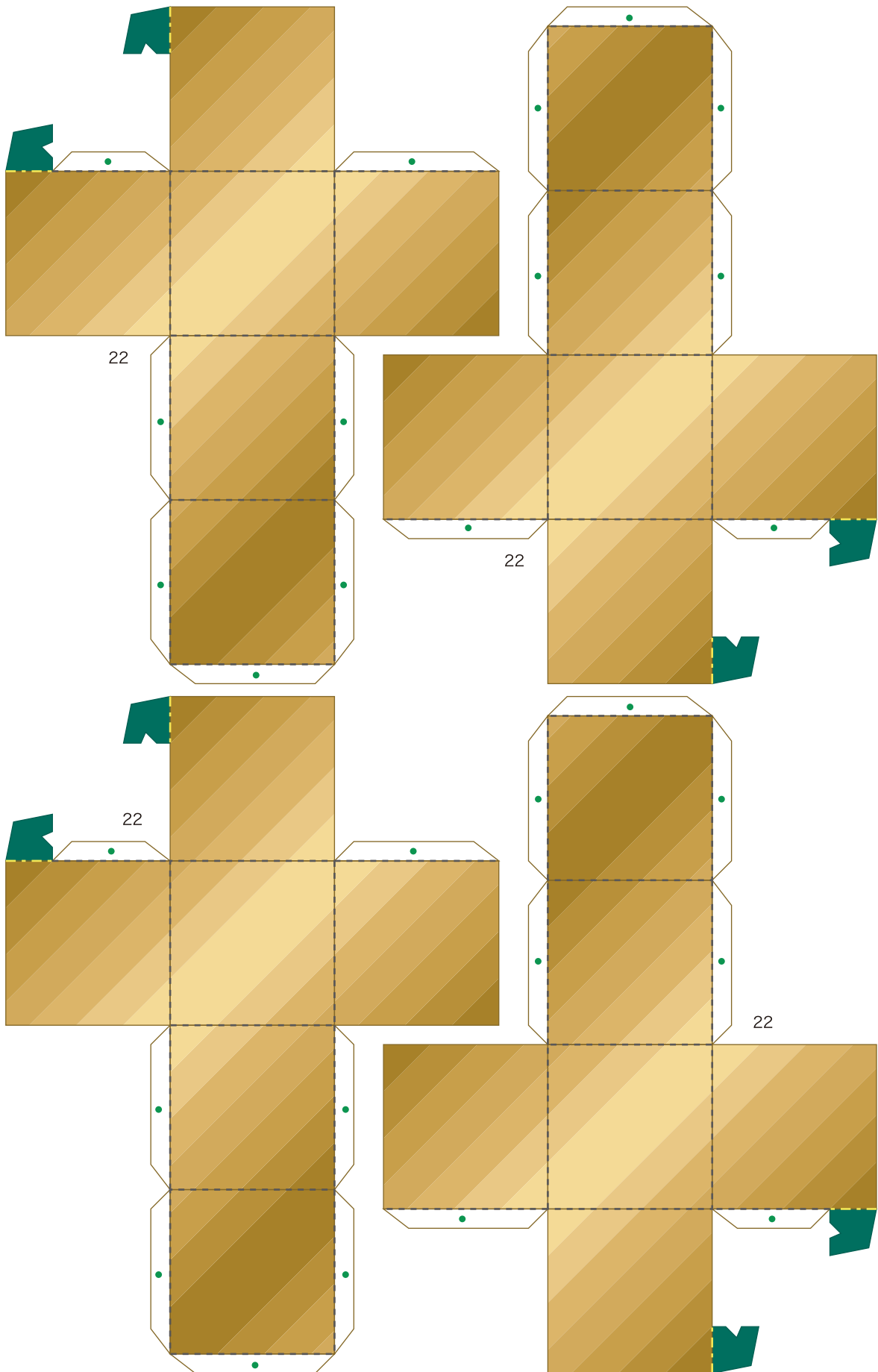

Christmas tree with ornaments (the ornaments): Pattern

© Canon Inc. © T. Ichiyama

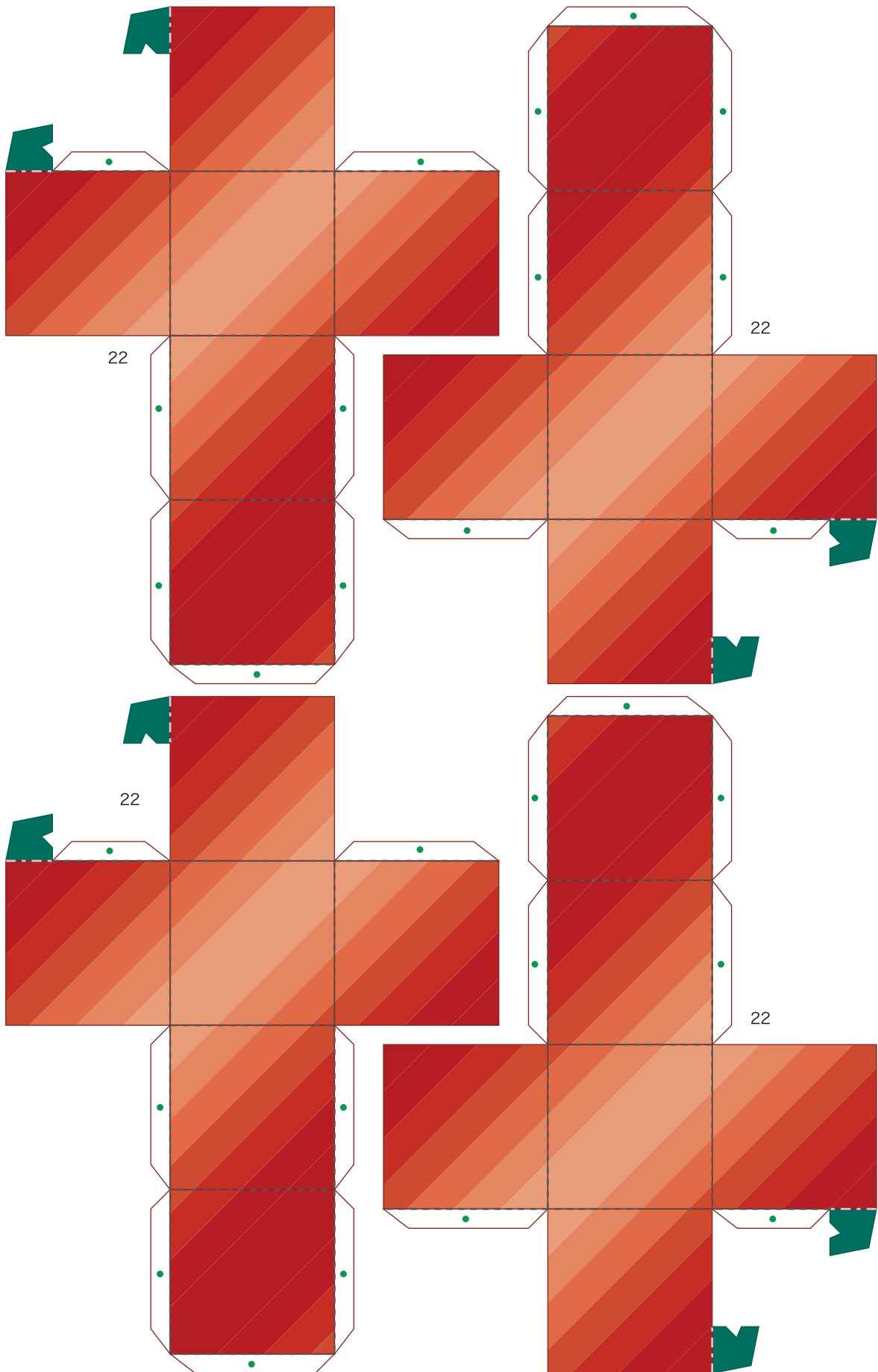

Christmas tree with ornaments (the ornaments): Pattern

© Canon Inc. © T. Ichiyama

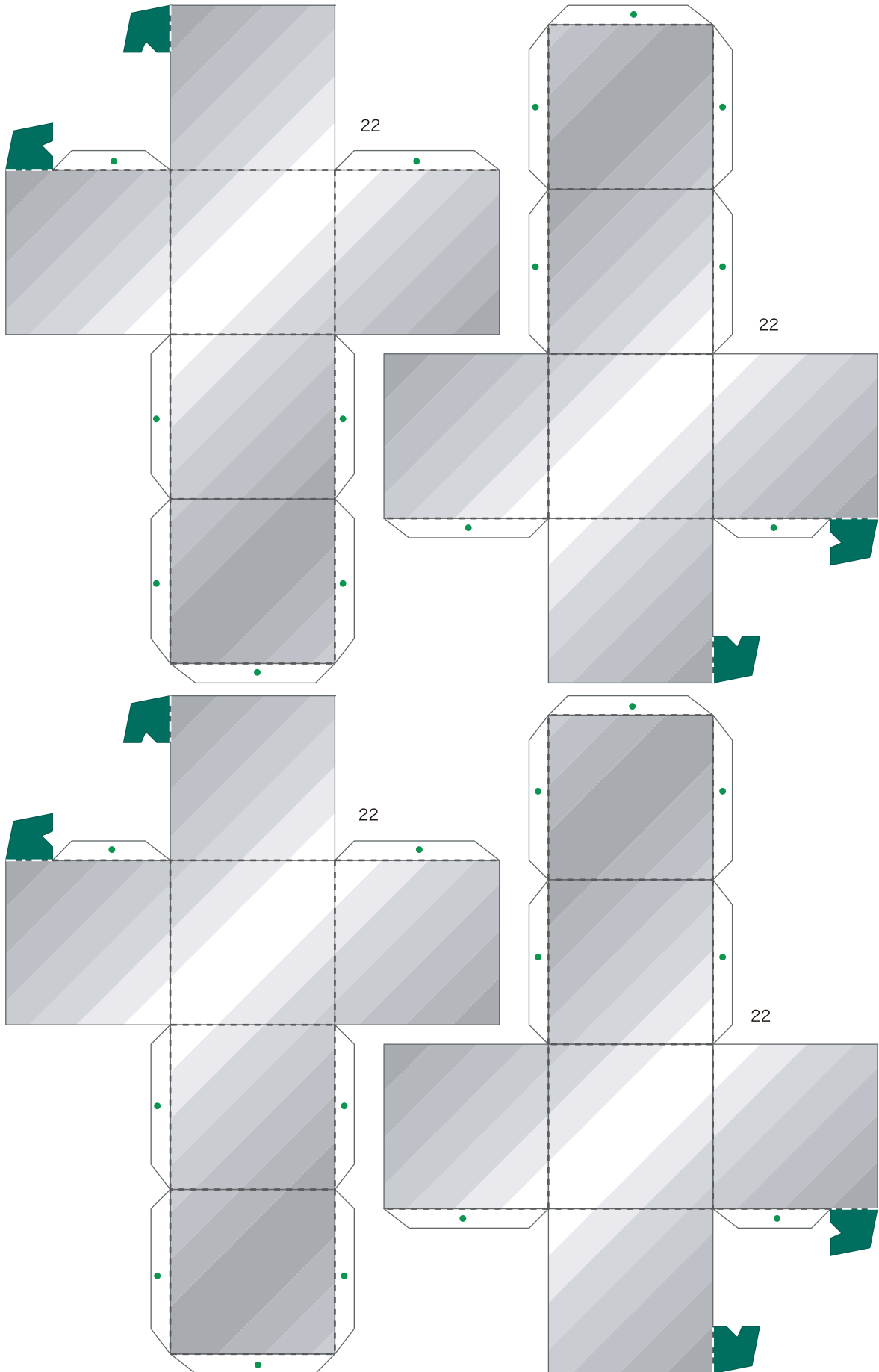

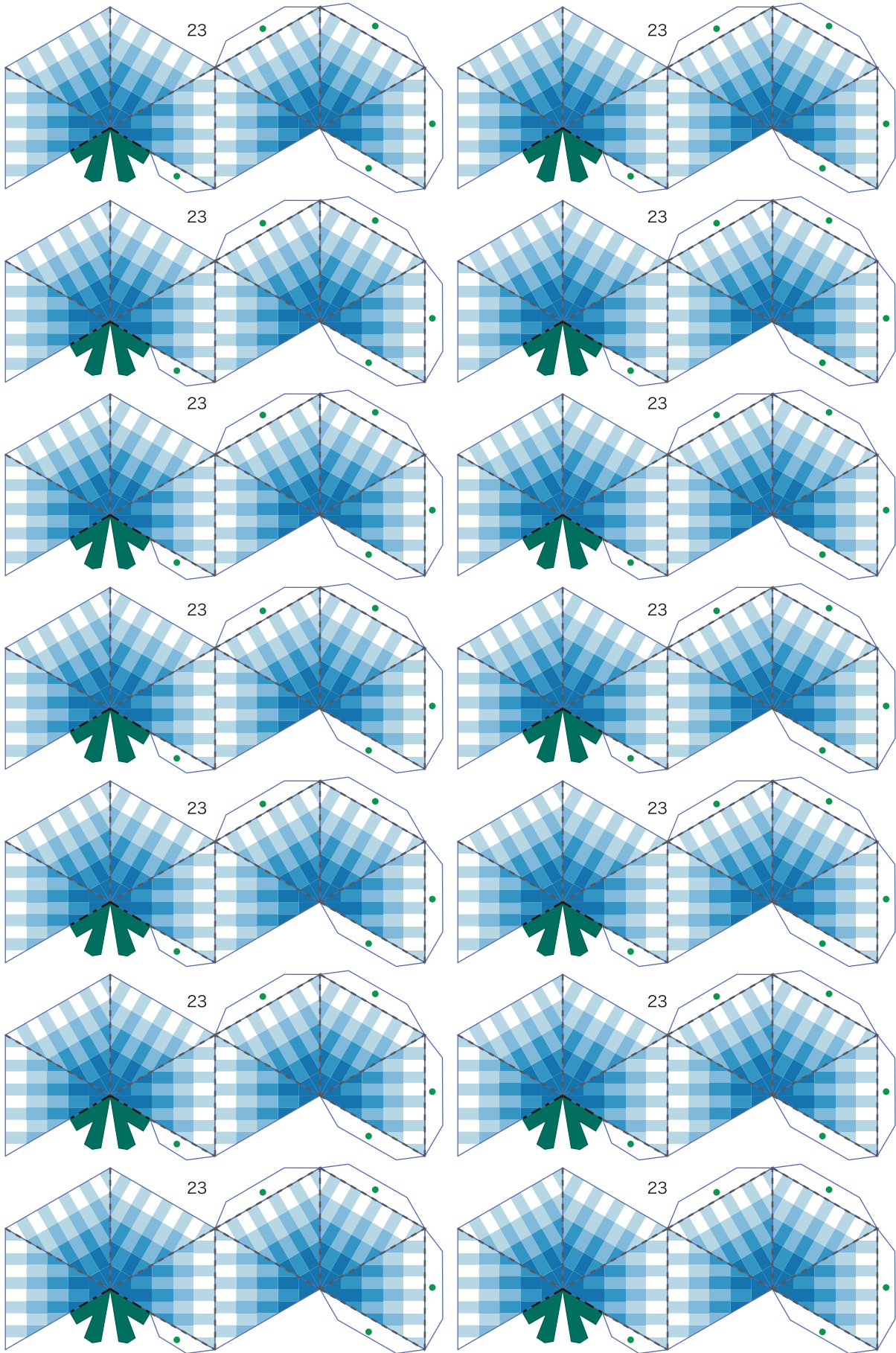

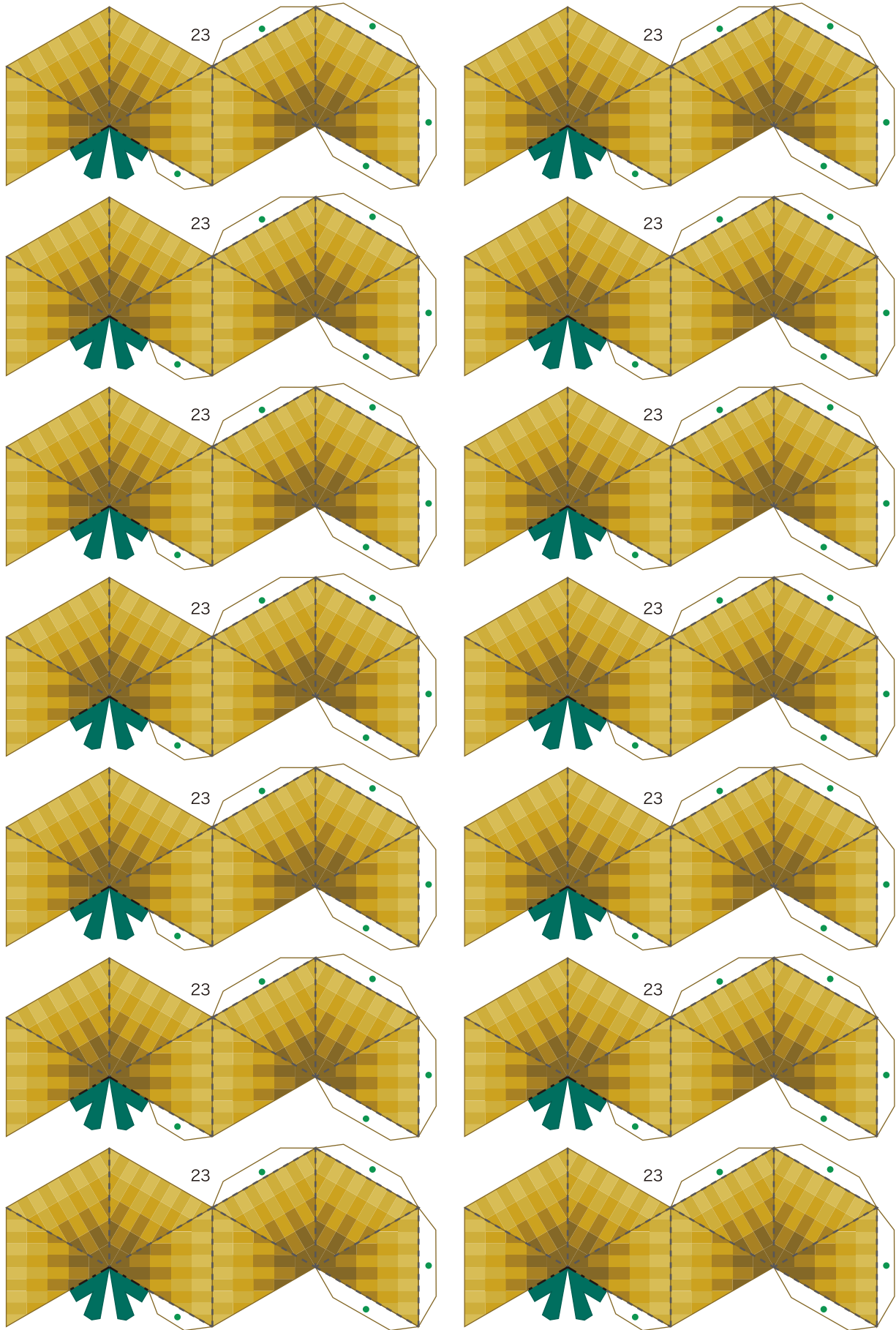

© Canon Inc. © T. Ichiyama

