

PAPER CRAFT

<http://www.canon.com/c-park/en/>



View of completed model

Assembly Instructions: Seven A4 sheets (No.1 to No.7)

*Build the model by carefully reading the Assembly Instructions, in the parts sheet page order.

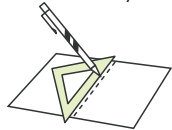

*Hint: Trace along the folds with a ruler and an exhausted pen (no ink) to get a sharper, easier fold.

Assembly Instructions



Mountain fold(dotted line)
Make a mountain fold.



Valley fold(dashed and dotted line)
Make a valley fold.



Scissors line(solid line)
Cut along the line.



Cut in line(solid line)
Cut along the line.

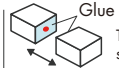

Glue
The glue spot(colored dot) shows where to apply the glue.

Glue spot(Red dot)
Glue parts with the same number together.

Glue spot(Green dot)
Glue within the same part.

Glue spot(Blue dot)
Glue to the rear of the other part.

Tools and materials



Scissors, set square, glue(We recommend stick glue), pencil, used ballpoint pen, toothpicks, tweezers, (useful for handling small parts)

Assembly tip



Before gluing, crease the paper along mountain fold and valley fold lines and make sure rounded sections are nice and stiff.

Caution



Glue, scissors and other tools may be dangerous to young children so be sure to keep them out of the reach of young children.

Before starting assembly: Writing the number of each section on its back side before cutting out the sections is highly recommended.
(* This way, you can be sure which section is which even after cutting out the sections.)

→ Indicates where sections should be glued together.
→ Indicates where to insert sections. Do not glue the sections together.

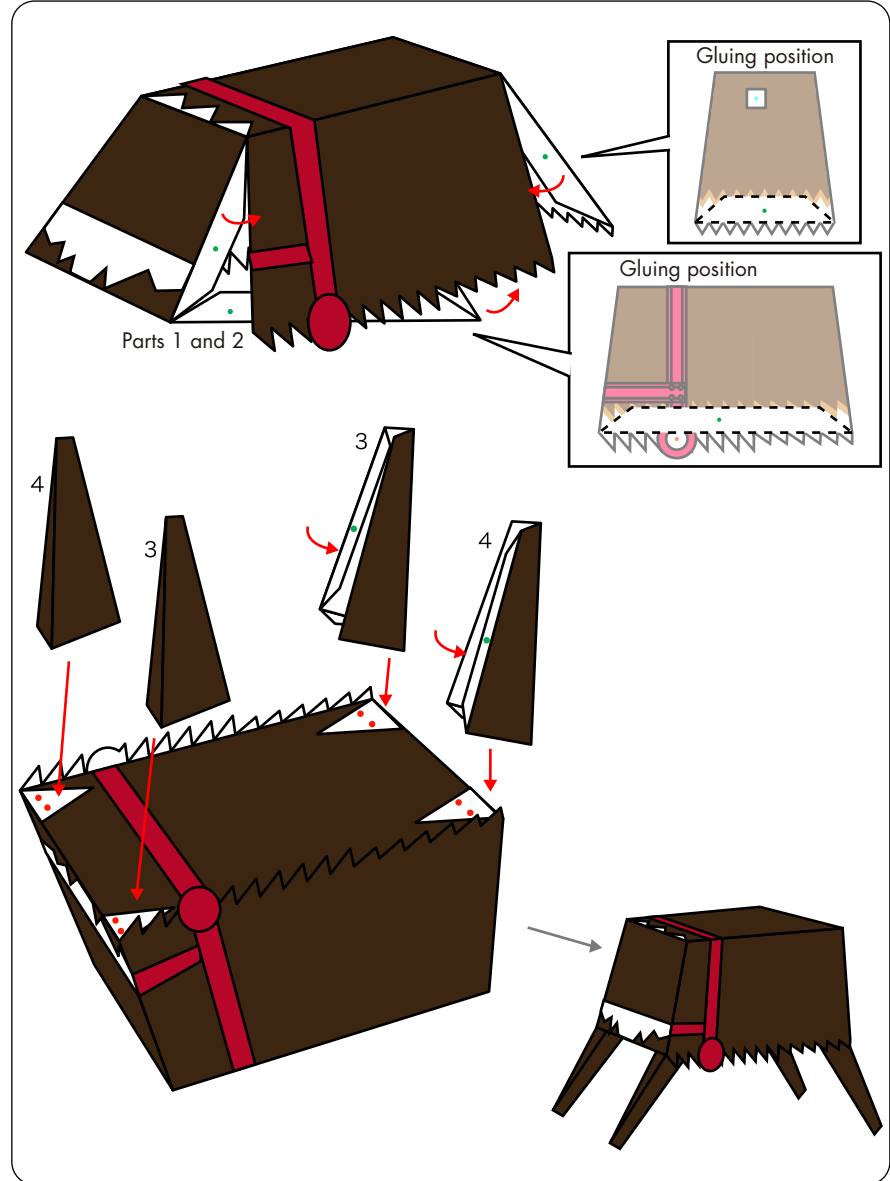

Santa Claus in his sleigh: Assembly Instructions

© Canon Inc. © T. Ichiyama

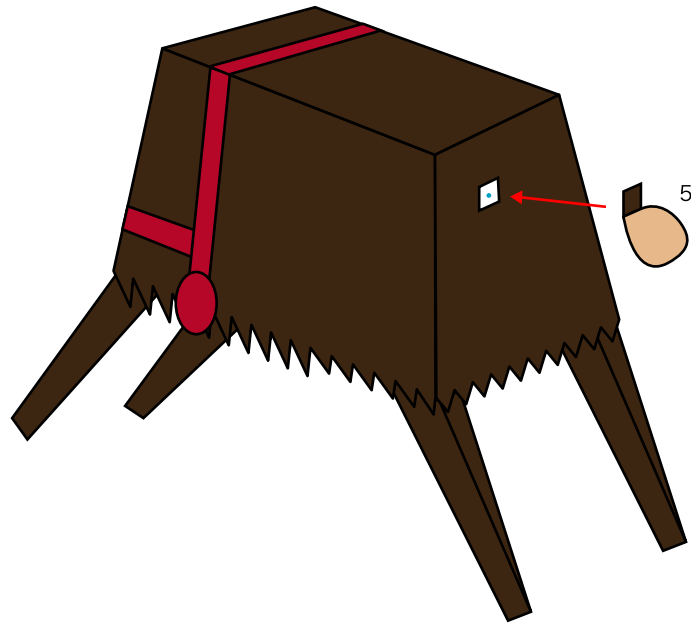

Parts 6 and 12

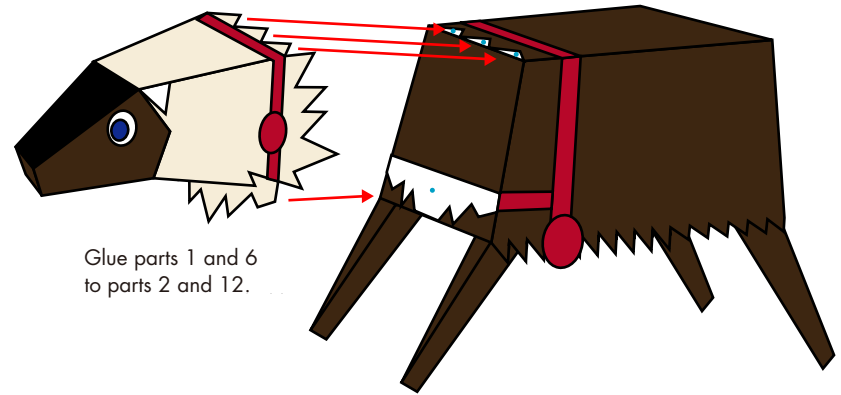
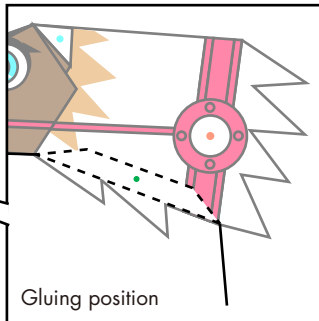
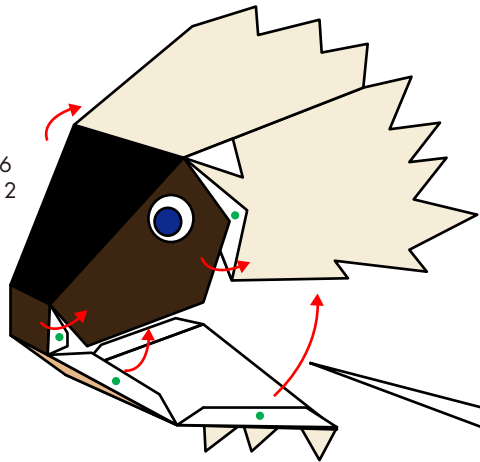

Glue parts 1 and 6 to parts 2 and 12.

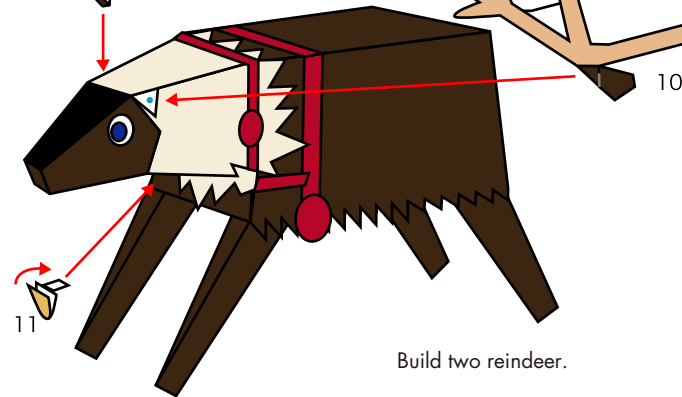
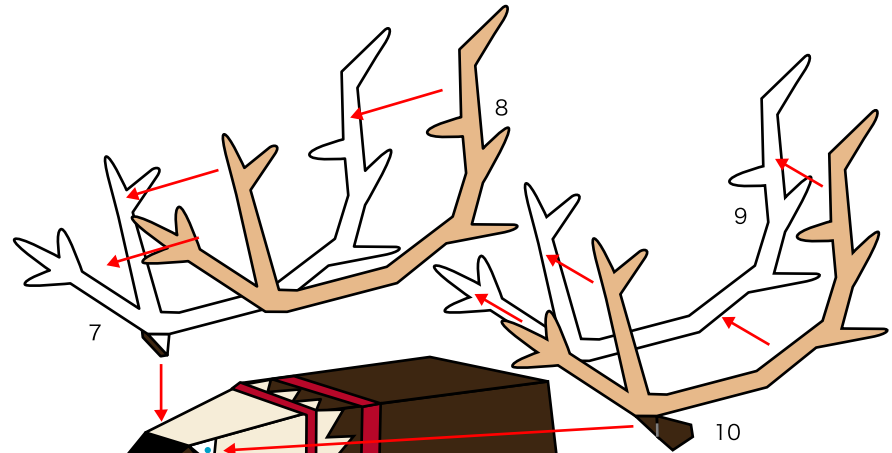

Build two reindeer.

Santa Claus in his sleigh: Assembly Instructions

© Canon Inc. © T. Ichiyama

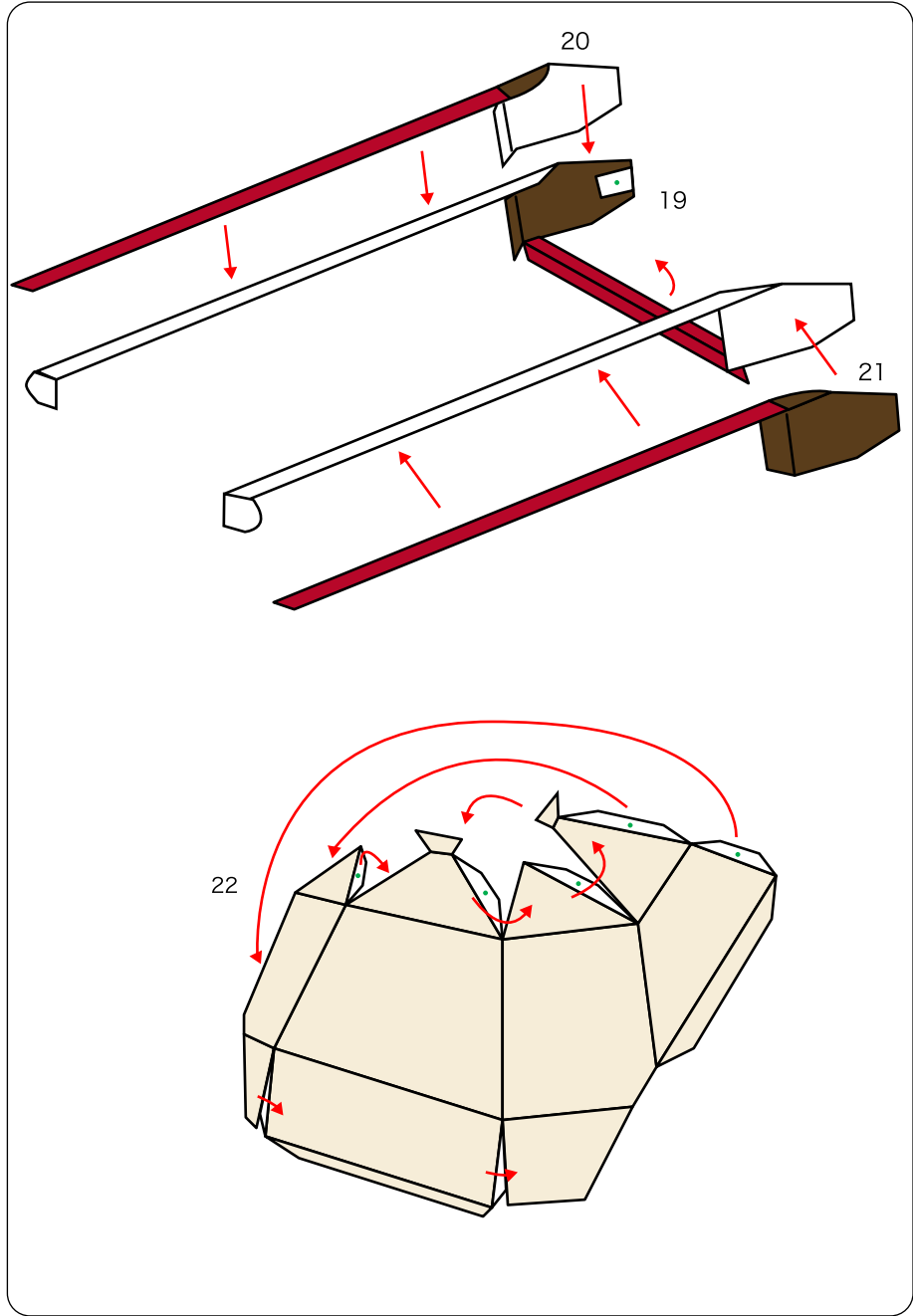
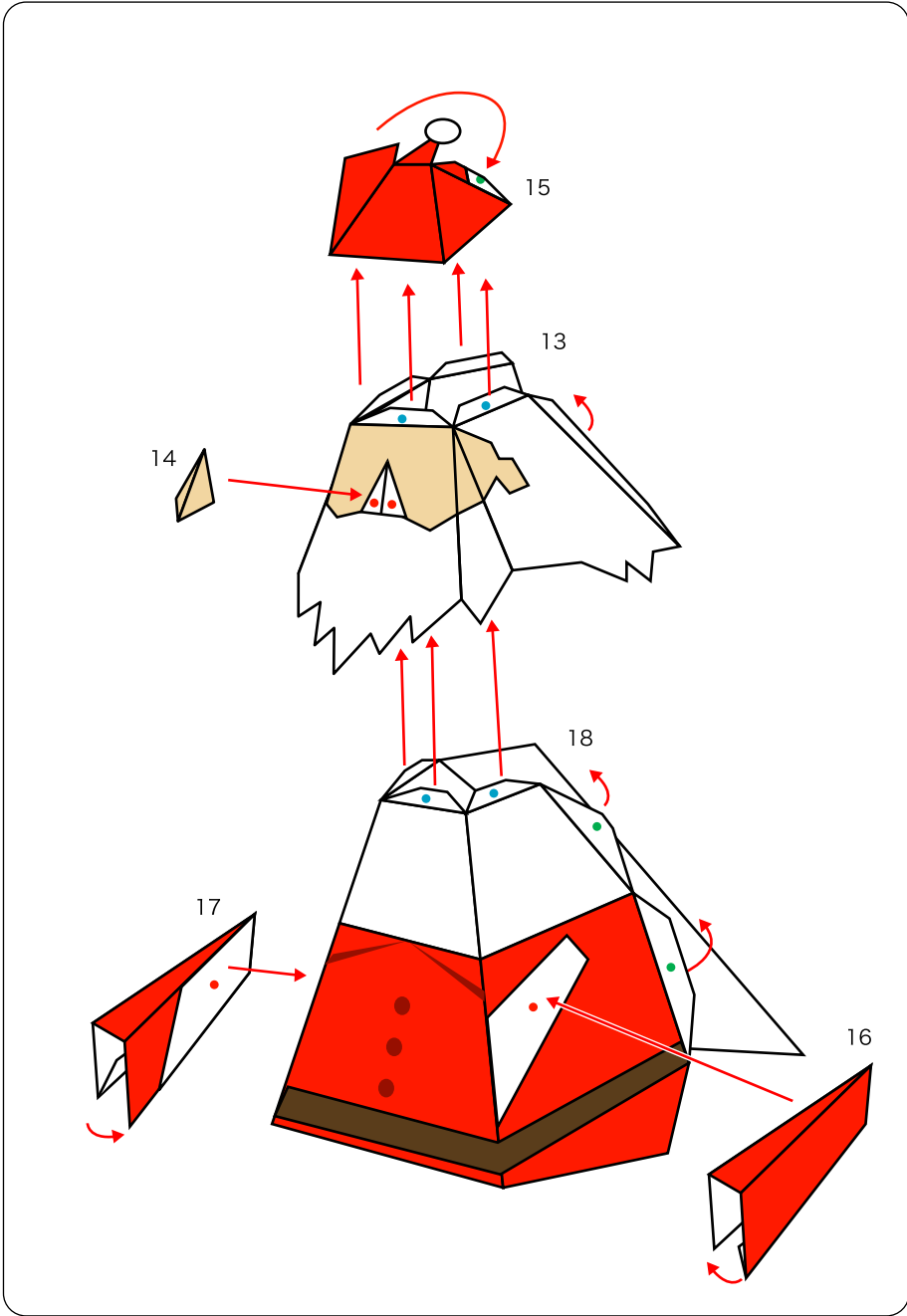

Santa Claus in his sleigh: Assembly Instructions

© Canon Inc. © T. Ichiyama

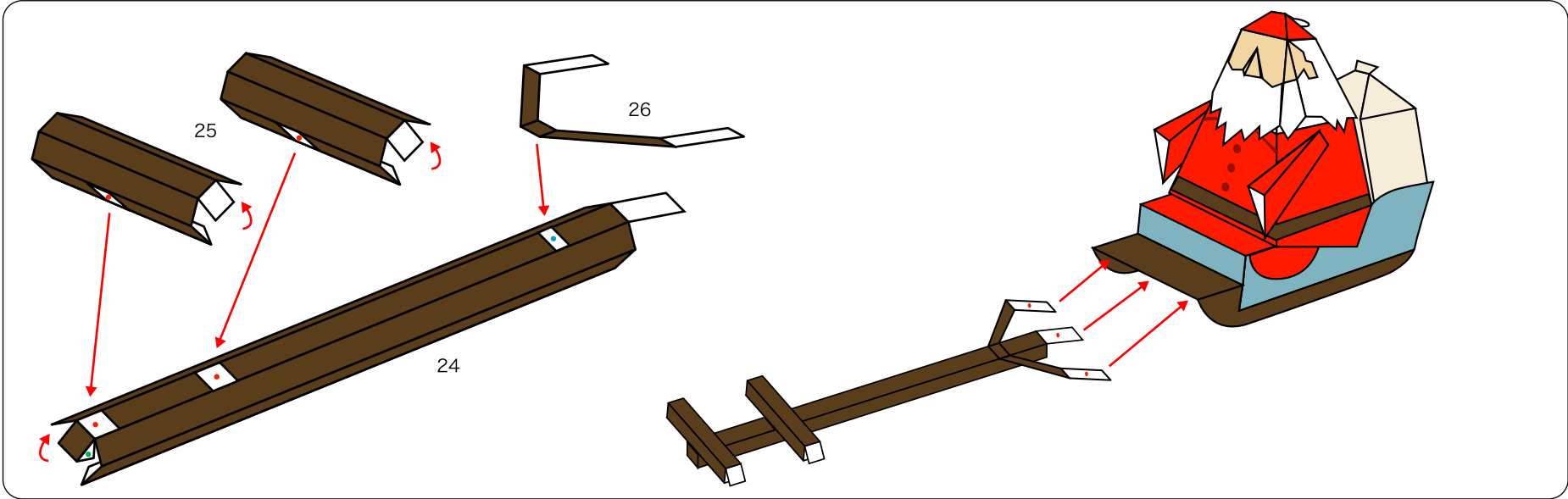
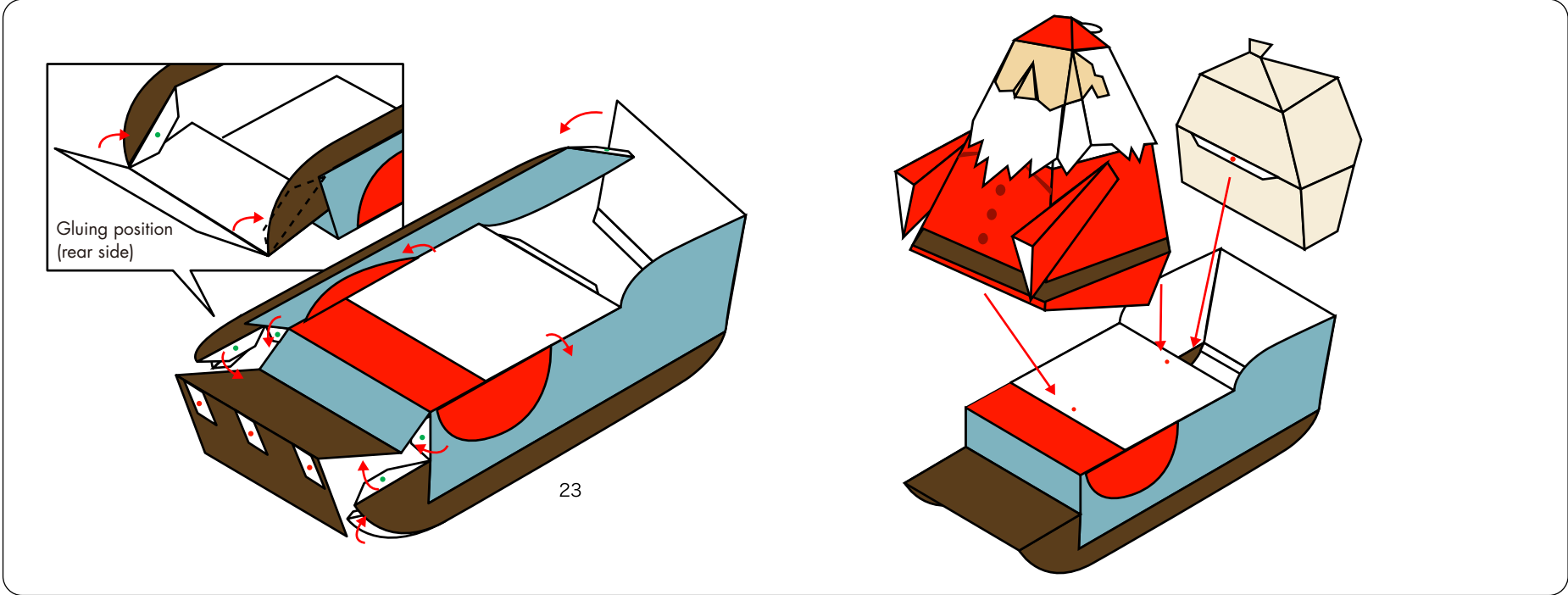

Santa Claus in his sleigh: Assembly Instructions

© Canon Inc. © T. Ichiyama

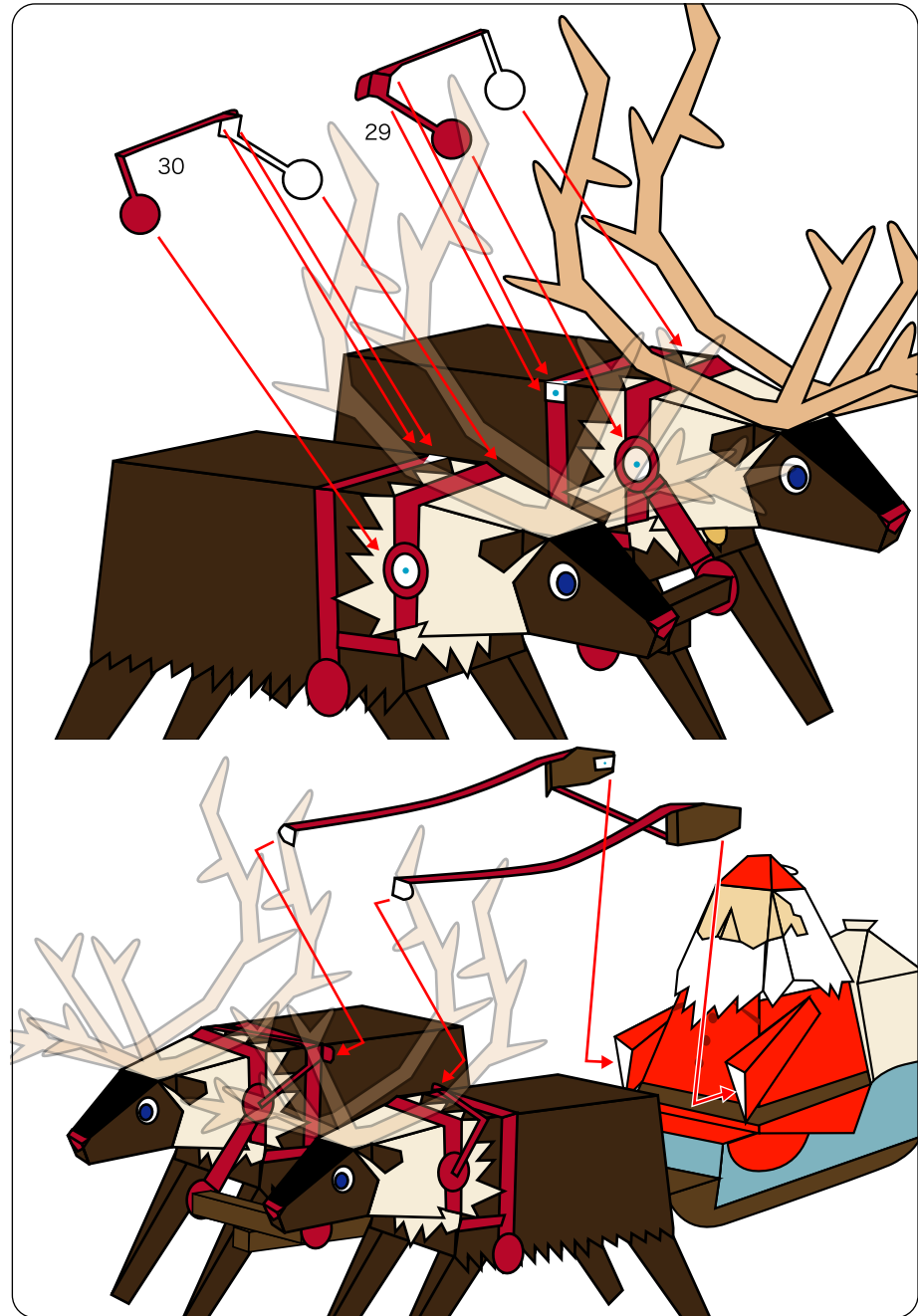
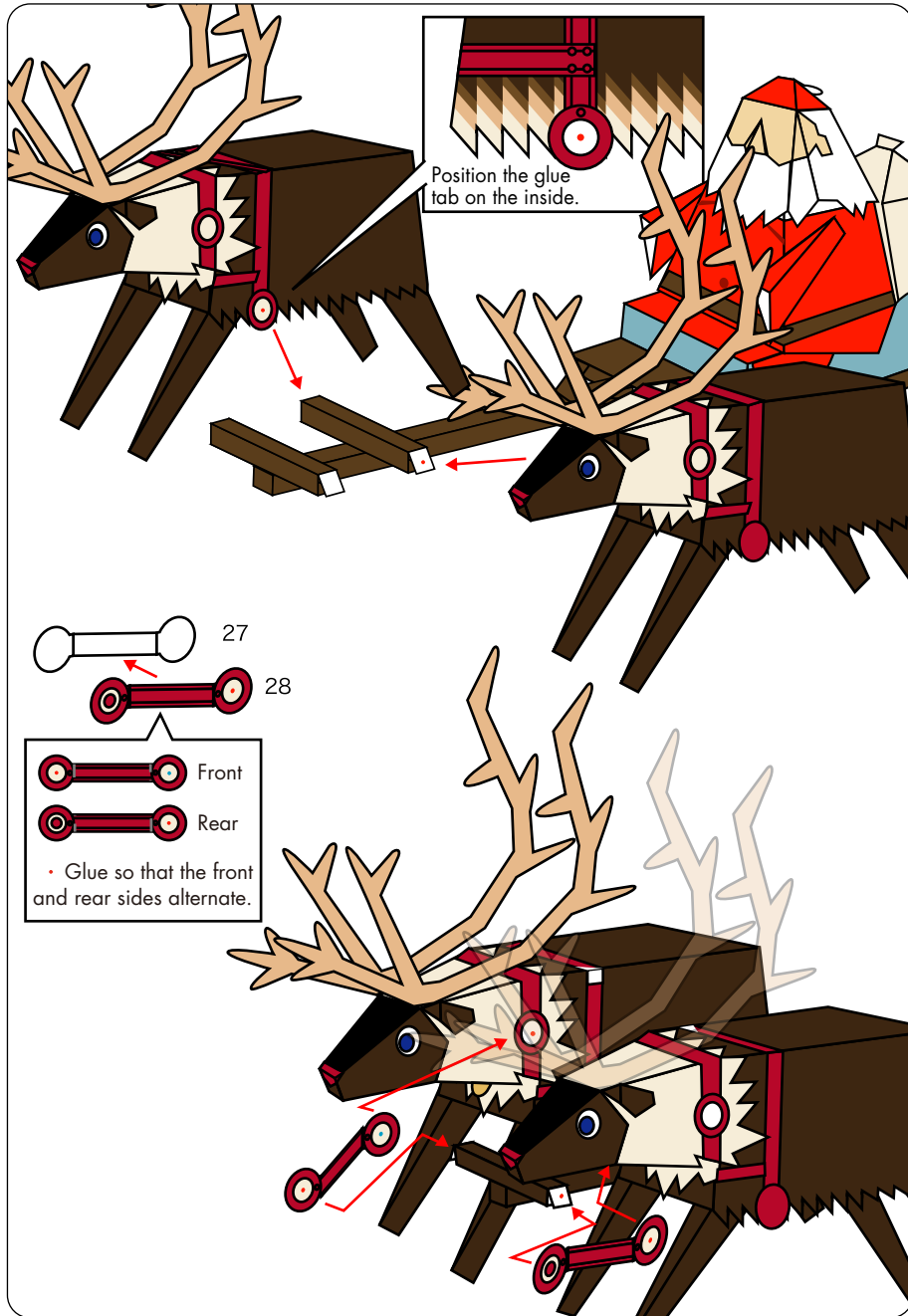

Santa Claus in his sleigh: Assembly Instructions

© Canon Inc. © T. Ichiyama

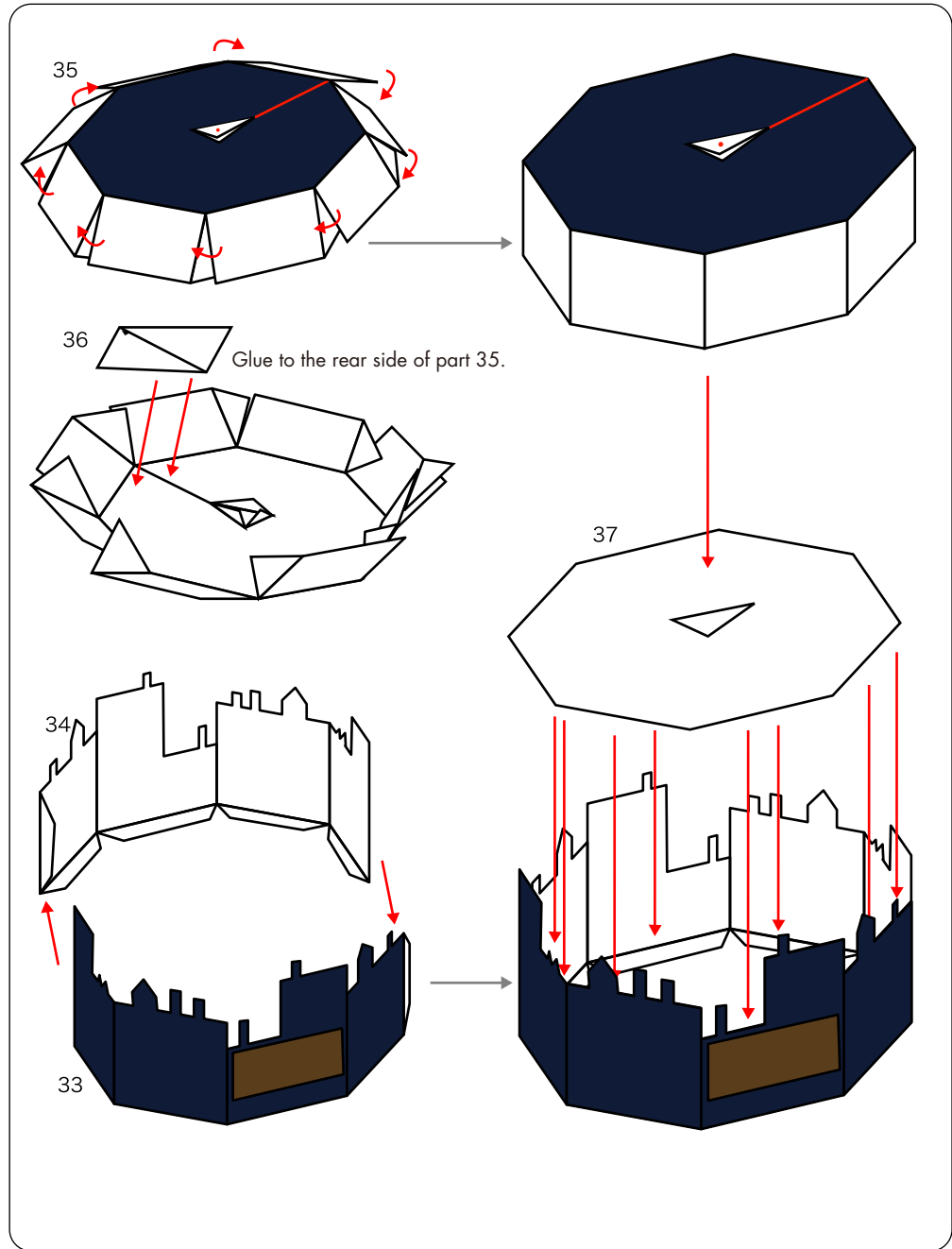
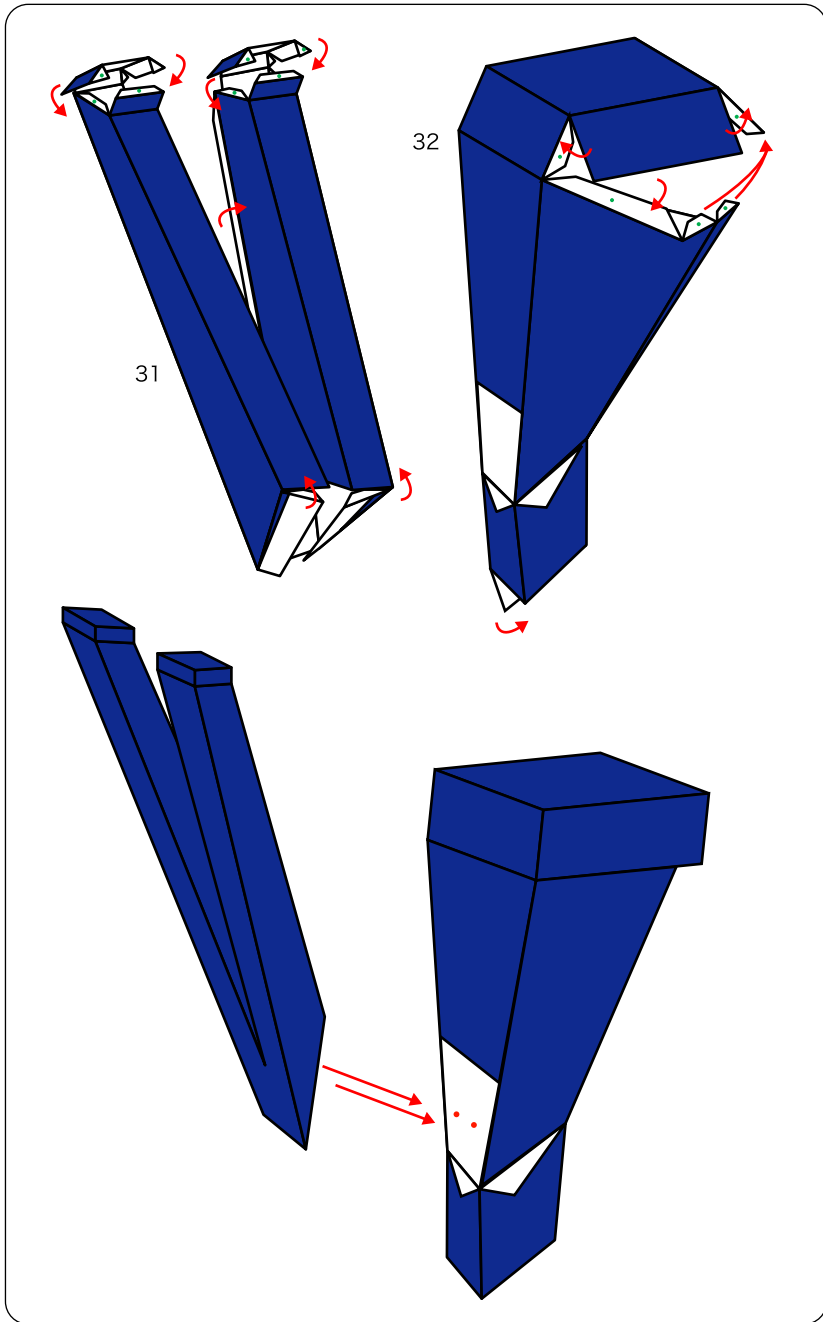

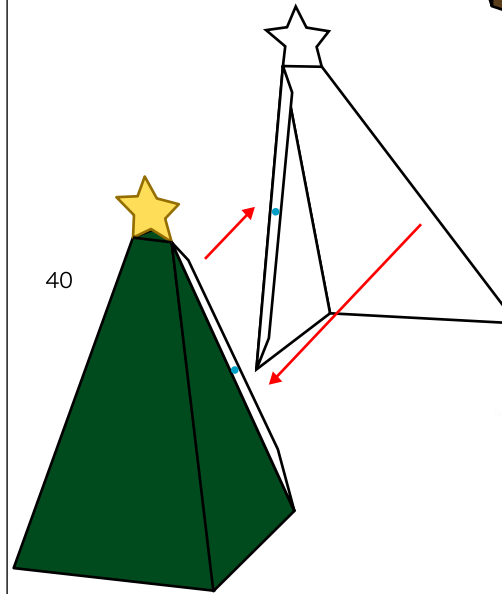
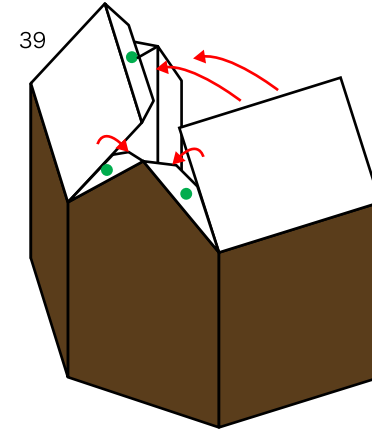
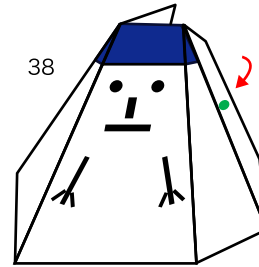
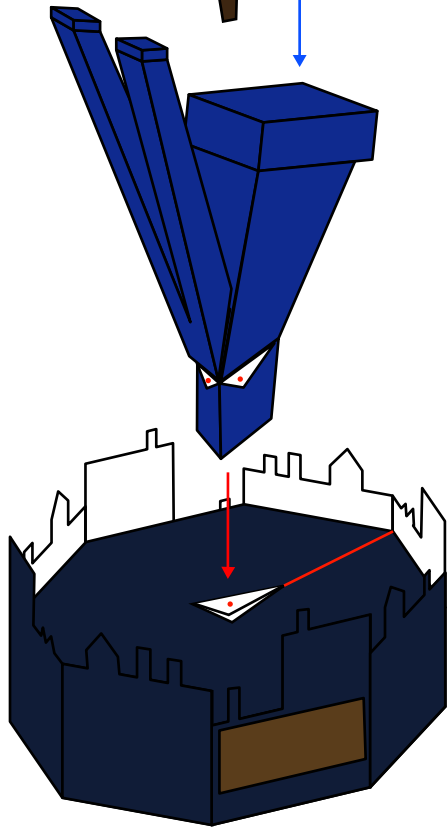

Position the Christmas tree, the cottage, and the snowman on the stand. You're model is finished!