

# Jack-o'-lantern family (Halloween): Assembly Instructions

© Canon Inc. © A.A Inc.



## PAPER CRAFT

<http://www.canon.com/c-park/en/>



View of completed model

### Assembly Instructions: Six US letter sheets (No.1 to No.6)

\*Build the model by carefully reading the Assembly Instructions, in the parts sheet page order.

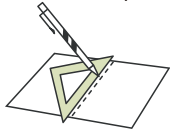

\*Hint: Trace along the folds with a ruler and an exhausted pen (no ink) to get a sharper, easier fold.

### Assembly Instructions



**Mountain fold(dotted line)**  
Make a mountain fold.



**Valley fold(dashed and dotted line)**  
Make a valley fold.



**Scissors line(solid line)**  
Cut along the line.



**Cut in line(solid line)**  
Cut along the line.

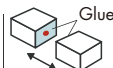

The glue spot(colored dot) shows where to apply the glue.

**Glue spot(Red dot)**  
Glue parts with the same number together.

**Glue spot(Green dot)**  
Glue within the same part.

**Glue spot(Blue dot)**  
Glue to the rear of the other part.

#### Tools and materials



Scissors, set square, glue(We recommend stick glue), pencil, used ballpoint pen, toothpicks, tweezers, (useful for handling small parts)

#### Assembly tip



Before gluing, crease the paper along mountain fold and valley fold lines and make sure rounded sections are nice and stiff.

#### Caution



Glue, scissors and other tools may be dangerous to young children so be sure to keep them out of the reach of young children.

Before starting assembly: Writing the number of each section on its back side before cutting out the sections is highly recommended. (\* This way, you can be sure which section is which even after cutting out the sections.)

→ Indicates where sections should be glued together.

(1) Assemble the stand.

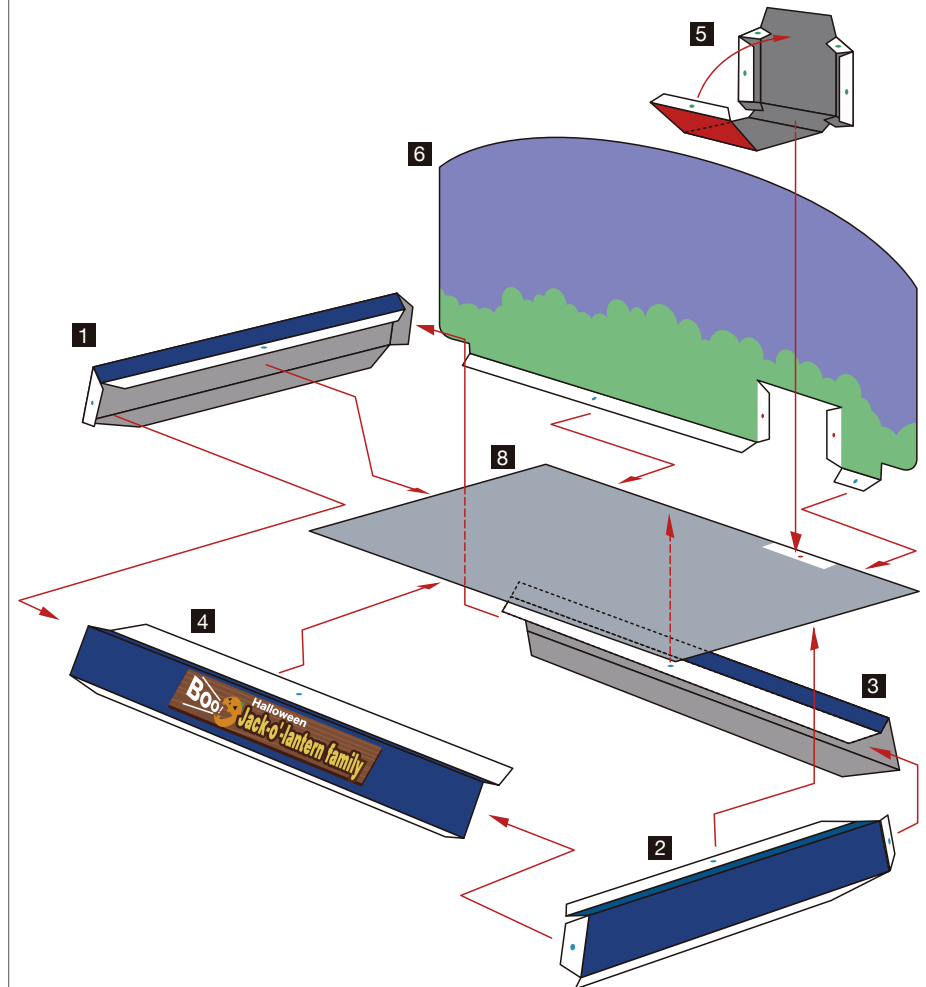

# Jack-o'-lantern family (Halloween): Assembly Instructions

© Canon Inc. © A.A Inc.



(2) Assemble the cart.

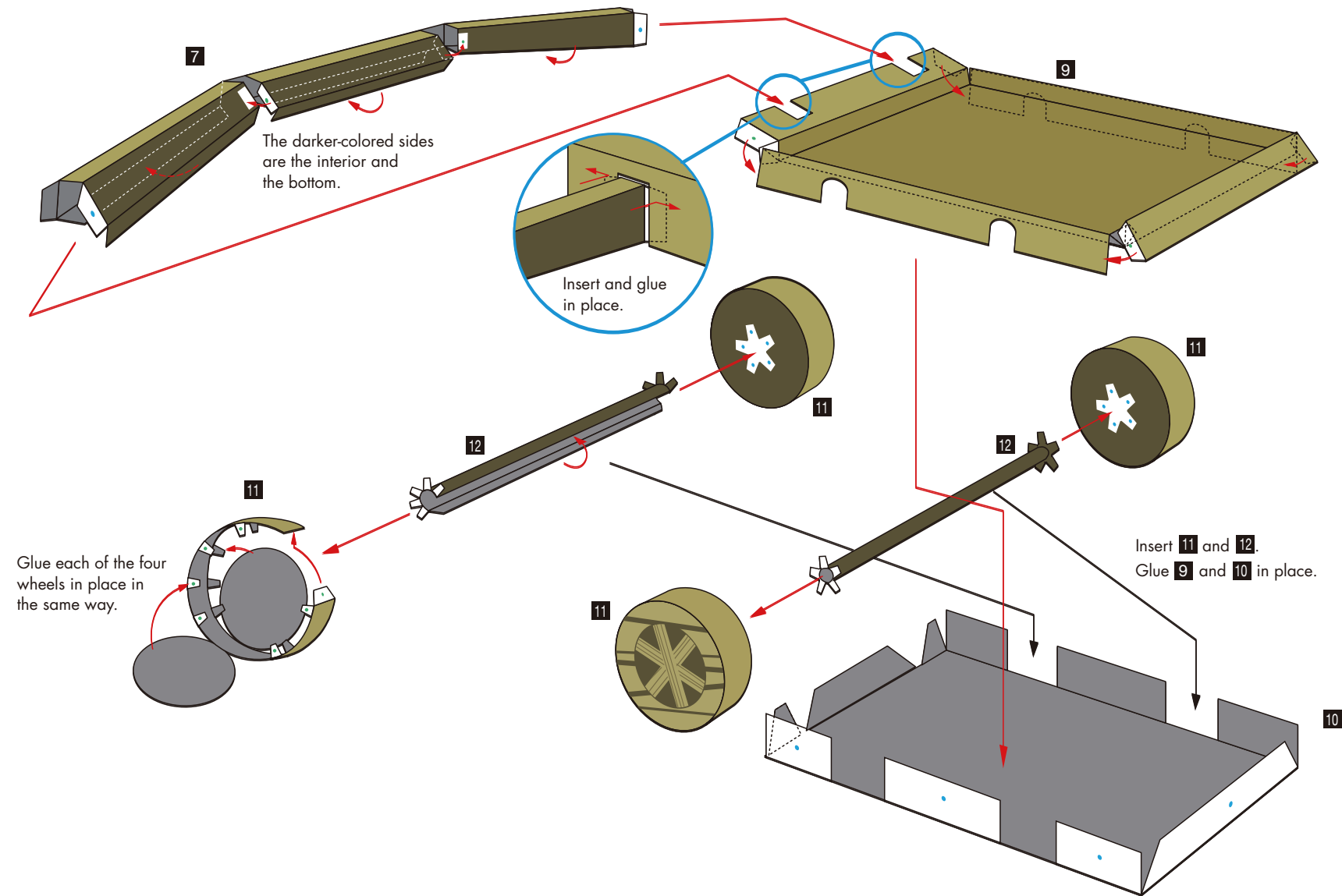

(3) Assemble the jack-o'-lanterns.

Small jack-o'-lantern

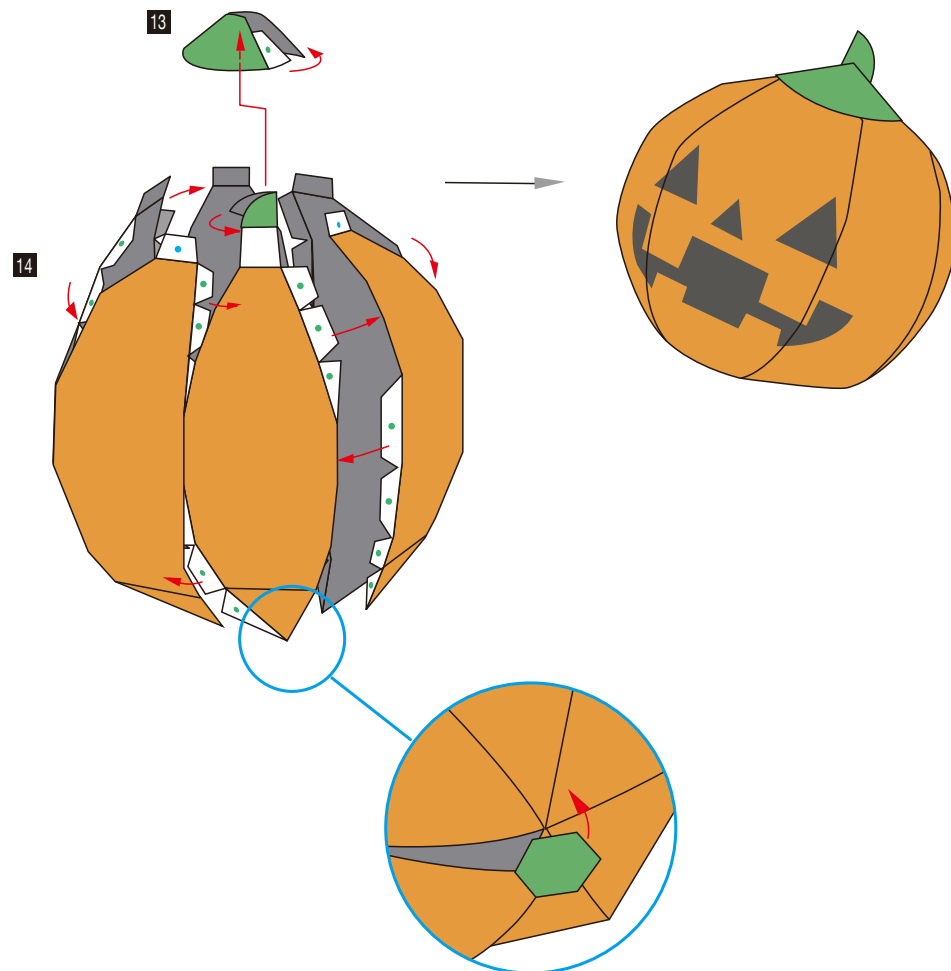

Medium jack-o'-lantern

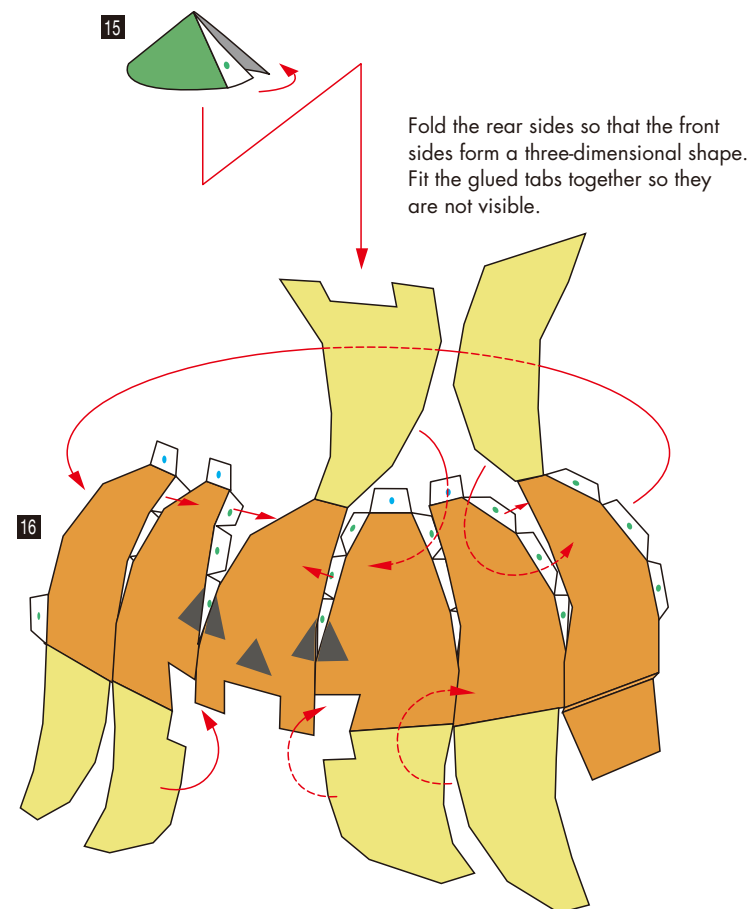

# Jack-o'-lantern family (Halloween): Assembly Instructions

© Canon Inc. © A.A Inc.



Fold the rear sides so that the front sides form a three-dimensional shape. Fit the glued tabs together so they are not visible.

17

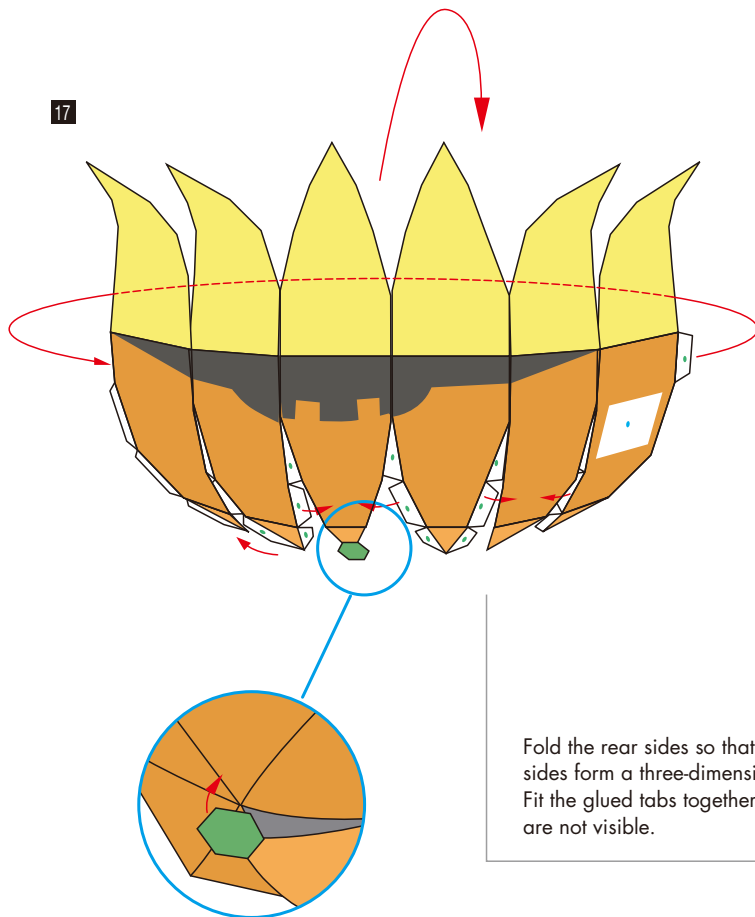

Fold the rear sides so that the front sides form a three-dimensional shape. Fit the glued tabs together so they are not visible.

17

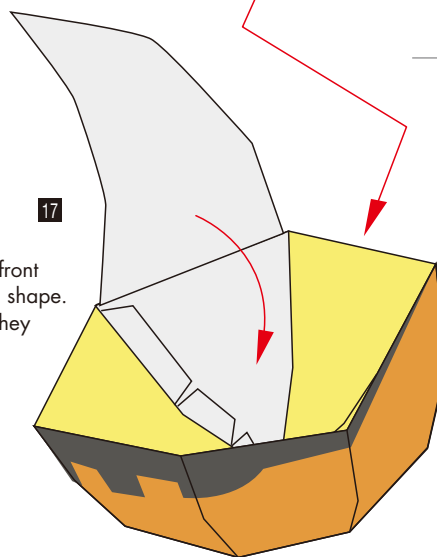

15 16



# Jack-o'-lantern family (Halloween): Assembly Instructions

© Canon Inc. © A.A Inc.



Large jack-o'-lantern

20

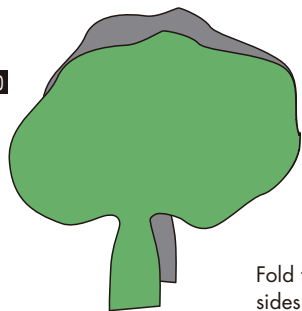

18 19 20

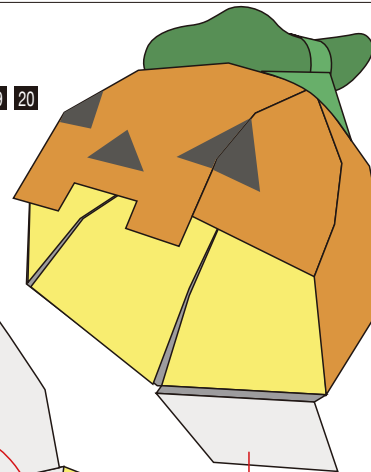

Fold the rear sides so that the front sides form a three-dimensional shape. Fit the glued tabs together so they are not visible.

18

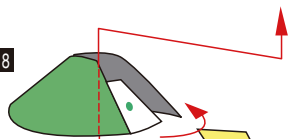

21

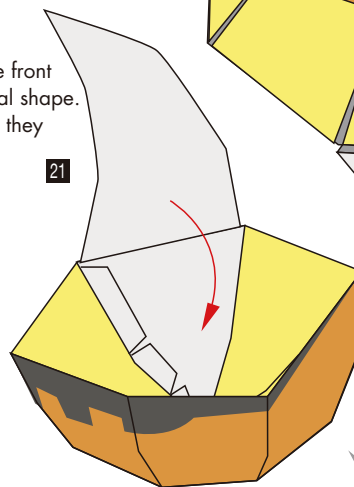

19

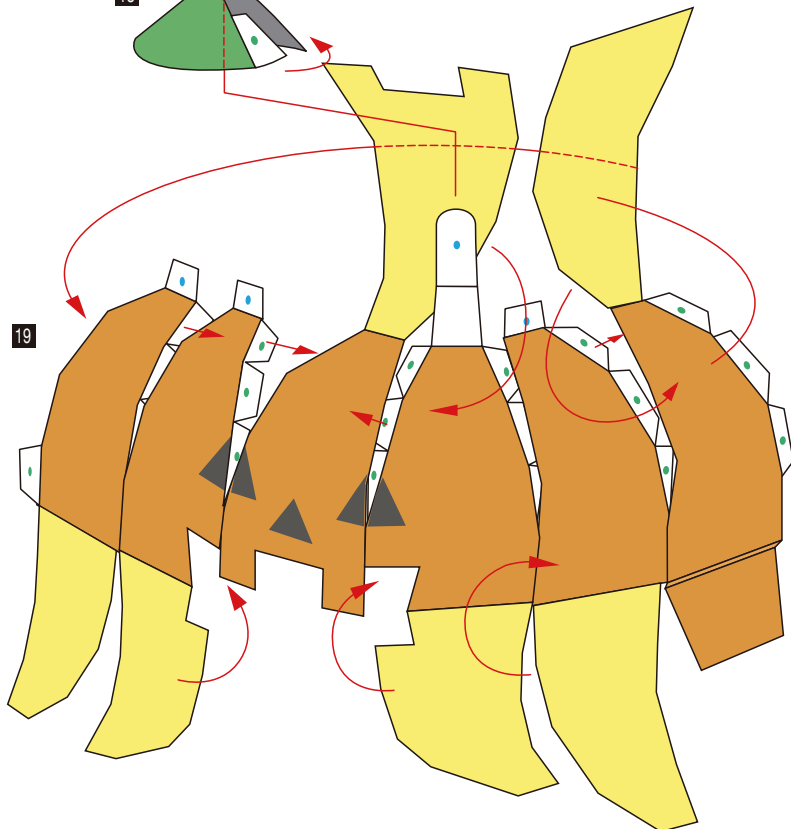

21

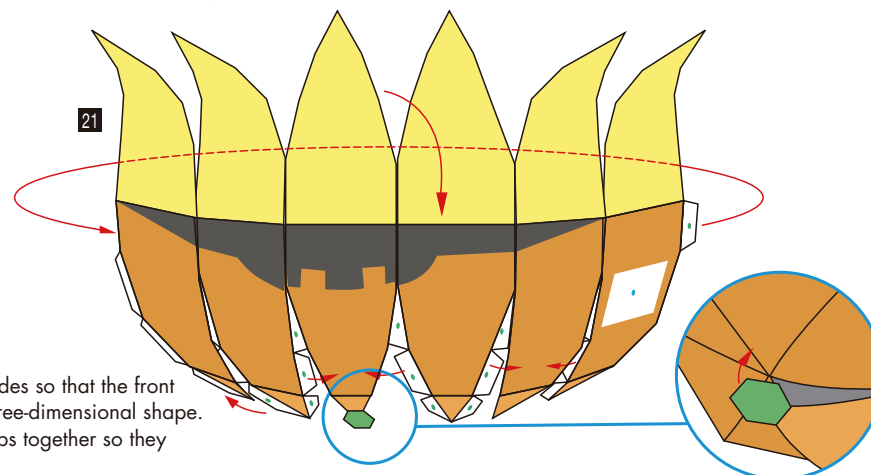

Fold the rear sides so that the front sides form a three-dimensional shape. Fit the glued tabs together so they are not visible.

# Jack-o'-lantern family (Halloween): Assembly Instructions

© Canon Inc. © A.A Inc.



(4) Position the assembled (1) base, (2) cart, and (3) jack-o'-lanterns.

(3) Jack-o'-lanterns

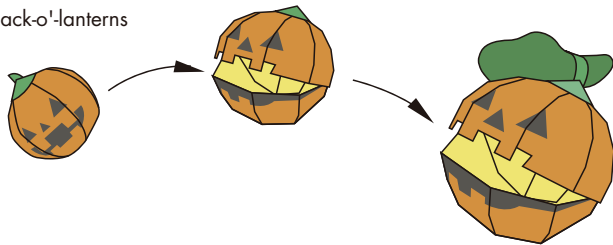

(2) Cart

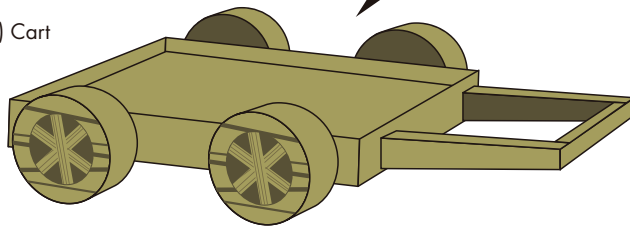

Finished!

(1) Stand

