

## PAPER CRAFT

<http://www.canon.com/c-park/en/>



View of completed model

### Assembly Instructions : Six A4 sheets (No. 1 to No. 6)

\* Build the model by carefully reading the Assembly Instructions , in the parts sheet page order.

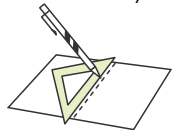

\*Hint: Trace along the folds with a ruler and an exhausted pen (no ink) to get a sharper, easier fold.

### Assembly Instructions



**Mountain fold(dotted line)**  
Make a mountain fold.



**Valley fold(dashed and dotted line)**  
Make a valley fold.



**Scissors line(solid line)**  
Cut along the line.



**Cut in line(solid line)**  
Cut along the line.

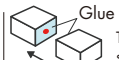

**Glue**  
The glue spot(colored dot) shows where to apply the glue.



**Glue spot(Red dot)**  
Glue parts with the same number together.



**Glue spot(Green dot)**  
Glue within the same part.



**Glue spot(Blue dot)**  
Glue to the rear of the other part.

#### Tools and materials



Scissors, set square, glue(We recommend stick glue), pencil, used ballpoint pen, toothpicks, tweezers, (useful for handling small parts)

#### Assembly tip



Before gluing, crease the paper along mountain fold and valley fold lines and make sure rounded sections are nice and stiff.

#### Caution



Glue, scissors and other tools may be dangerous to young children so be sure to keep them out of the reach of young children.

Before starting assembly :  
Writing the number of each section on its back side before cutting out the sections is highly recommended.  
(\* This way, you can be sure which section is which even after cutting out the sections.)

→ Indicates where sections should be glued together.  
→ Indicates where to insert sections. Do not glue the sections together.

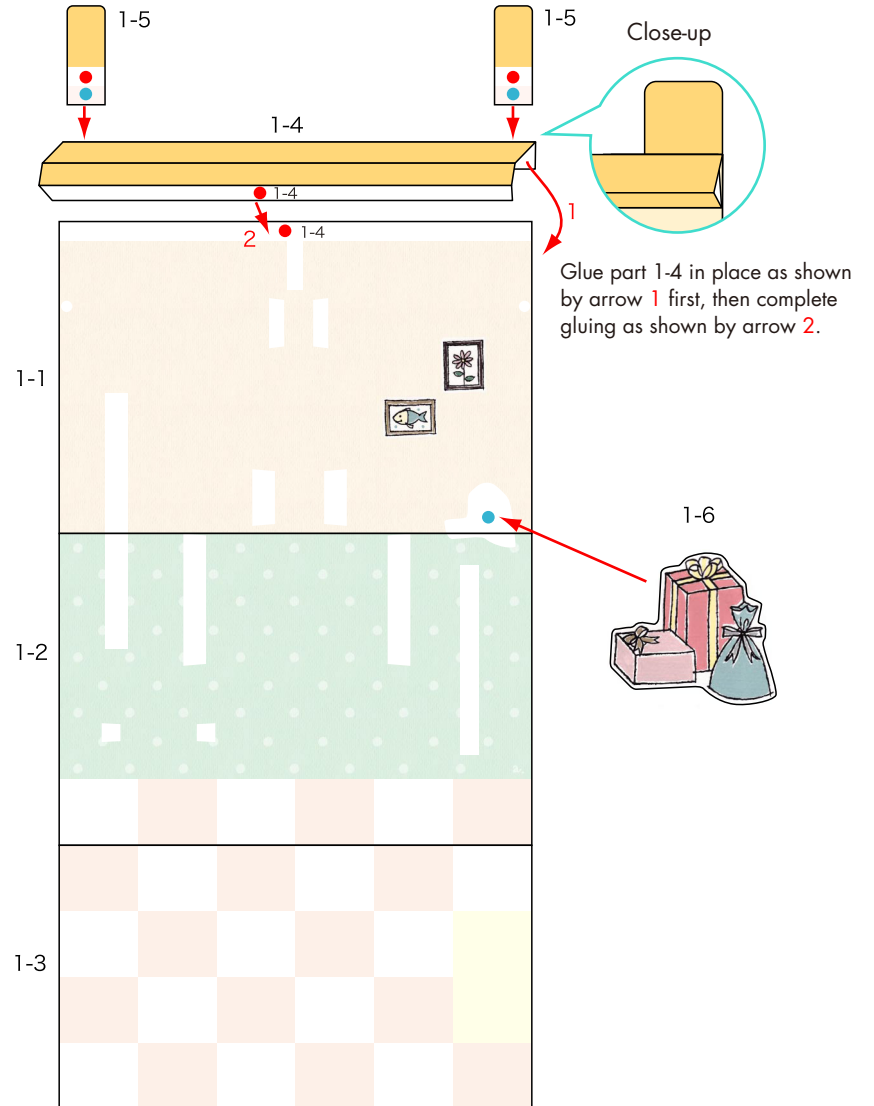

# Birthday countdown calendar : Assembly Instructions

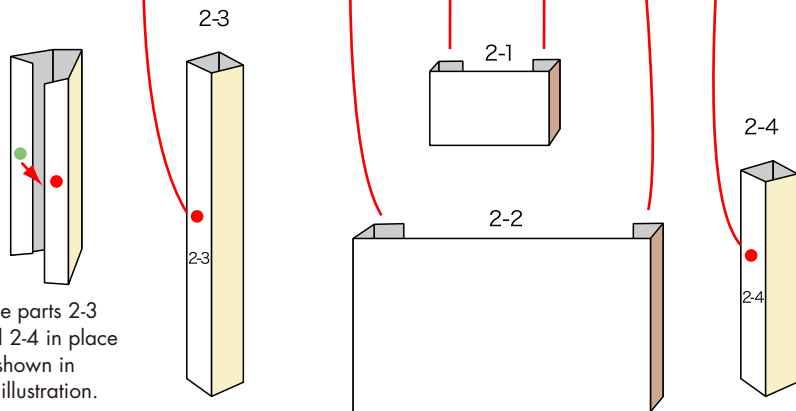
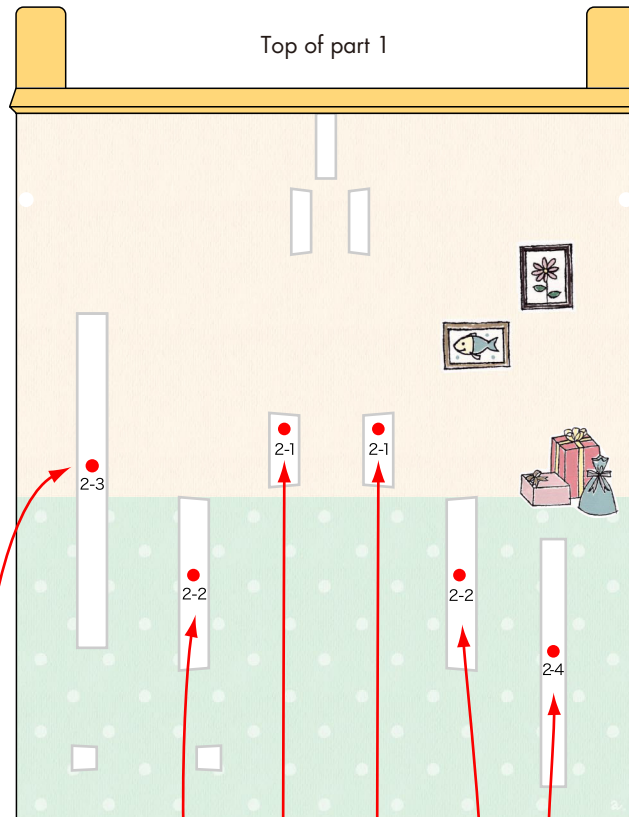

Glue parts 2-3 and 2-4 in place as shown in the illustration.

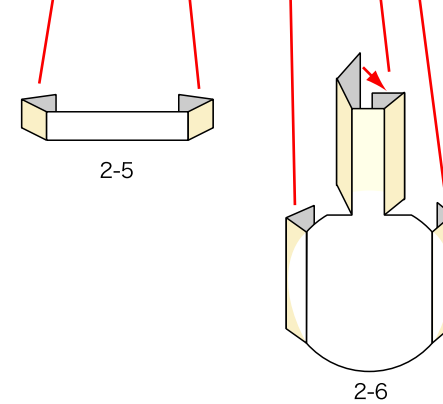
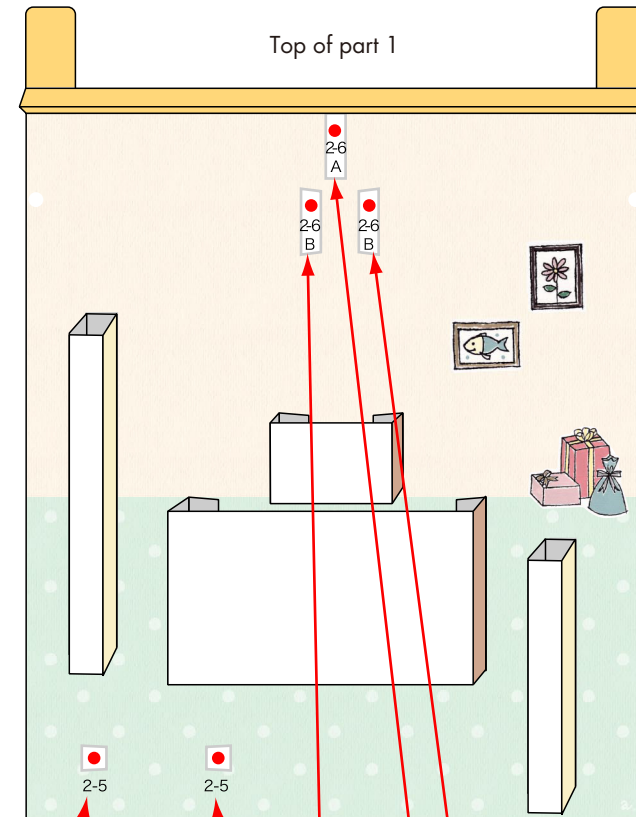

After applying glue to the green glue spot on part 2-6, glue it to the red glue spots on 2-6A and 2-6B.

# Birthday countdown calendar : Assembly Instructions

## Assembling the festive ball

2-12

2-14  
7 Jul  
Part 2-14 comes in 12 types.  
Glue in place the part with the number of the birthday month.

2-15  
27  
Part 2-15 comes in 31 types.  
Glue in place the part with the number of the birthday date.

For example,  
use the parts shown at left for a July 27 birthday.

2-12

2-13

2-12

2-13

2-13

Write the name of the birthday celebrant on the third section of part 2-13.

Glue the rear side of the "Happy" section of part 2-13 onto the rear side of part 2-12 (to the section shaded in yellow in the above illustration).

2-12

Slide the overlapping portion under the orange door.

Slide the overlapping portion under the yellow door.

The festive ball is complete!

2-11

Top of part 1

Festive ball

2-12

2-8

2-7

2-10

2-9

# Birthday countdown calendar : Assembly Instructions



The top of part 1 is complete!

## Assembling the date boxes (parts 3-1 through 3-31)

Part 3-31 is a calendar date.

Referring to the dates you wrote on the bottom of part 1, glue parts 3-1 through 3-29 in place. (Choose either the orange- or cream-colored parts.)

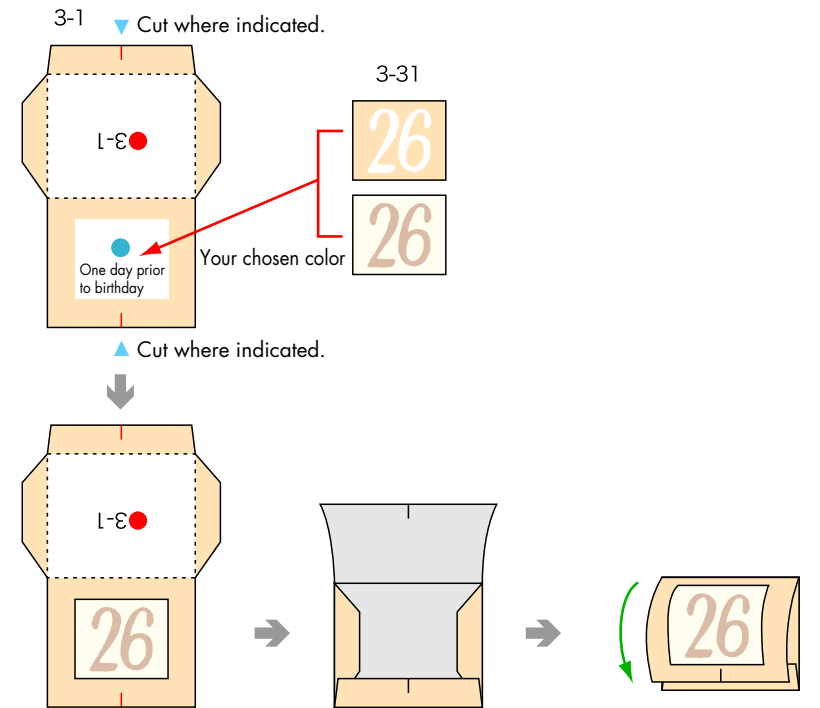

Curl the door while the glue is half-dry.

## Calculating the days of the countdown

Bottom of part 1

- 29 days 6/28	- 28 days 29	- 27 days 30	- 26 days 7/1	- 25 days 2	- 24 days 3
- 23 days 4	- 22 days 5	- 21 days 6	- 20 days 7	- 19 days 8	- 18 days 9
- 17 days 10	- 16 days 11	- 15 days 12	- 14 days 13	- 13 days 14	- 7 days 20
- 12 days 15	- 11 days 16	- 10 days 17	- 9 days 18	- 8 days 19	
- 6 days 21	- 5 days 22	- 4 days 23	- 3 days 24	- 2 days 25	- 1 days 26

In pencil, write the calendar dates from one through 29 days prior to the birthday, starting from the bottom right-hand corner of the bottom of part 1.

The illustration at left shows an example with a July 27 birthday.

Part 3-30 represents the month of each date. It is available in 12 types (one for each month). When using a date with a month different from that of part 3-29, glue this part at the upper left of the date.

3-30  
6



**Hint:**  
Since curling the door while the glue is half-dry gives the date box a firm shape, assemble the date boxes one at a time, moving on to the next date box only after completing the previous one.

# Birthday countdown calendar : Assembly Instructions

## Assembling the bottom of part 1



Glue the date boxes in place one at a time, starting from the upper left. Glue each date box in place on top of the matching number.

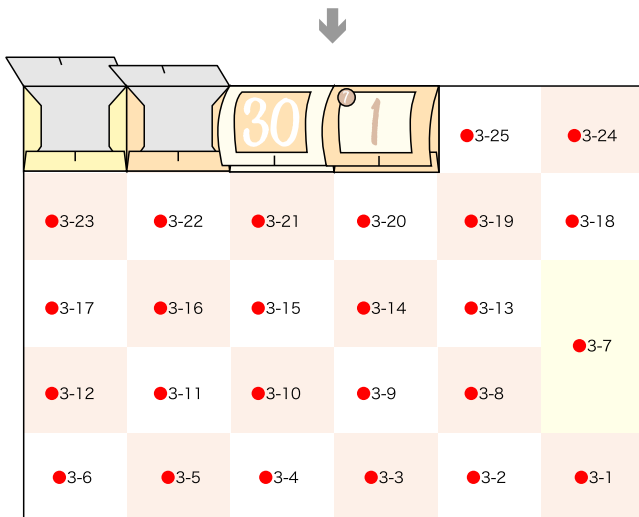
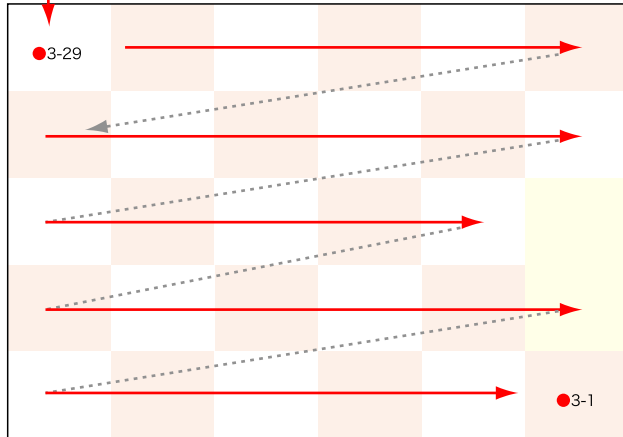

The illustration shows the example of a July 27 birthday.

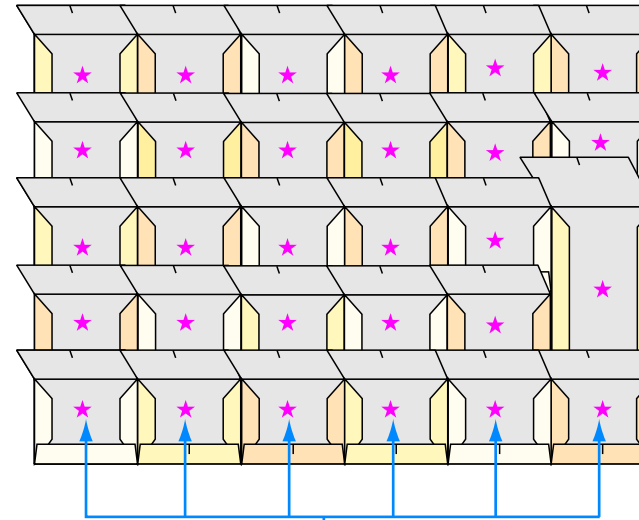

Place parts 4-1 through 4-29 in front of the star symbols in the 29 date boxes.

Put each selected item in the desired date box.

If you need more candles, print another sheet.





# Birthday countdown calendar : Assembly Instructions

Close the windows of the date boxes.

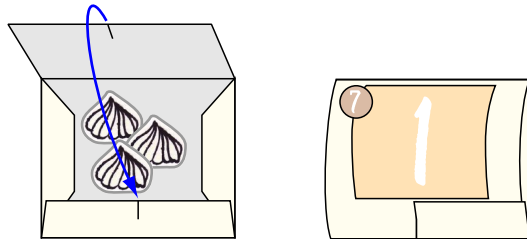

After putting parts 4-1 through 4-29 into the date boxes, close the windows by joining their notches together.



Your birthday countdown calendar is complete!

## How to use the birthday countdown calendar

Each day, open the window of one date box, starting 29 days prior to the birthday. Attach the decoration from inside the date box to any place on the calendar picture that you please.

Finally, open the doors of the festive ball on the 30th day, which is the birthday.

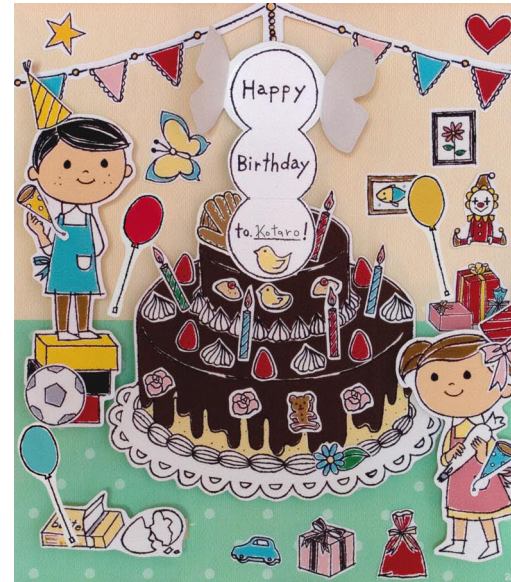

Decoration example

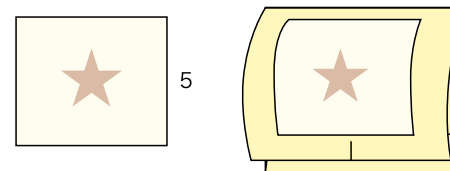

If you like, you can make it even more fun to count down the days until the birthday by gluing part 5 to the dates on the date boxes you have opened. When doing so, cut out part 5 and insert it at the very bottom of the item in each date box.

