

★ For best results use 80 gr/m<sup>2</sup> special coated paper If you have ink jet printer  
 ★ For best color matching use color reference tables for printer calibration

★ Use border scales to control the dimensions of the printed layout  
 ★ Print the layout with maximal available resolution

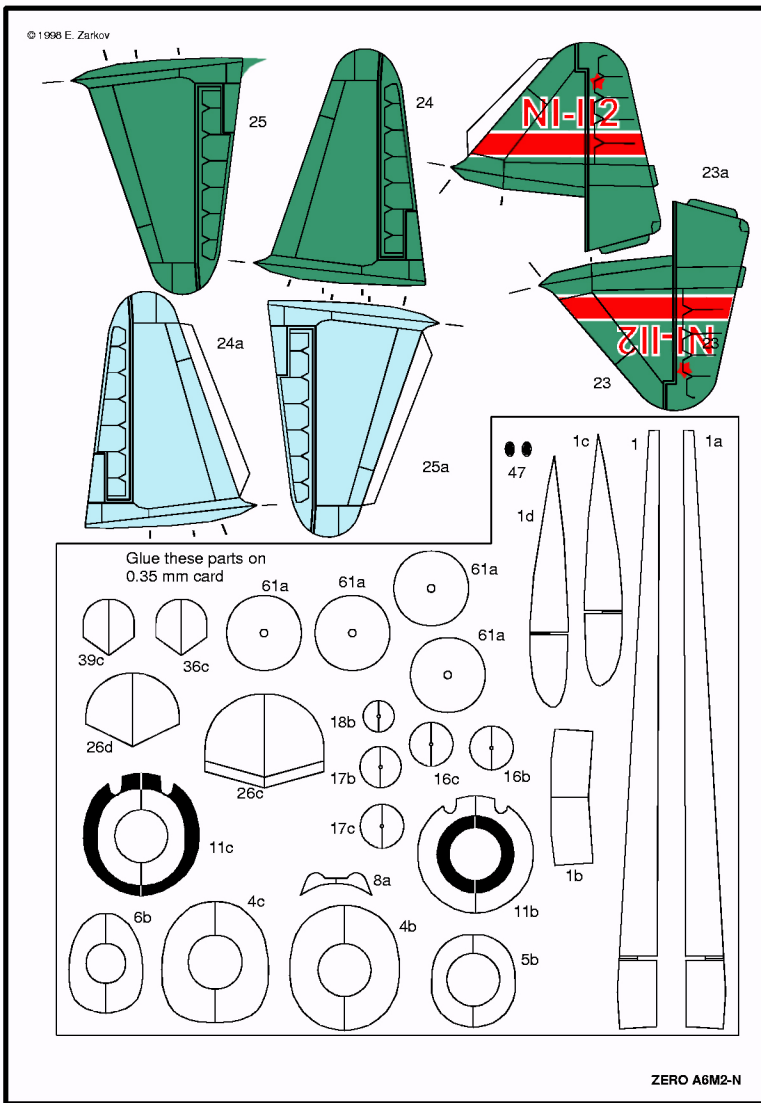

ModelArt® FOR YOUR COLLECTION 10

**MITSUBISHI A6M2 - N**

**ZERO**

1/72 scale **PRECISE CARD MODEL**

◆ Contains high quality cutouts and assembly instruction ◆ Printed in realistic colors ◆ High resemblance to prototype

At the time of its appearance the Zero Fighter performances were far superior to any existing fighter in the world. This was the most important factor for the Japanese fateful decision of attacking the United States. Even with the large float attached this navy version of the Zero preserved its remarkable flying characteristics.

**FAMOUS WW II FIGHTERS**

Scale 1:72

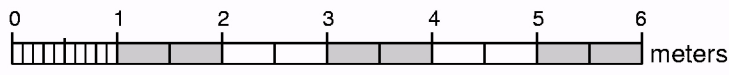

★ For individual use only, under no circumstances can this document be resold without written permission by ModelArt.  
 ★ You can contact us sending E-mail to: [modelart@tusk.icn.bg](mailto:modelart@tusk.icn.bg)

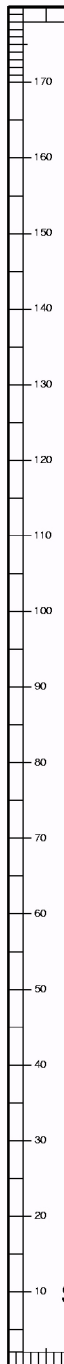
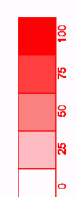
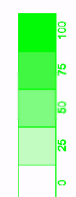
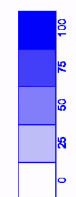
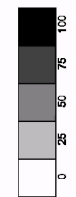
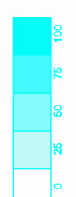
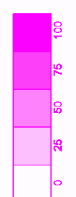
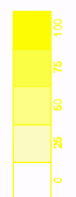
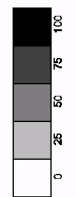

★ For best results use 80 gr/m<sup>2</sup> special coated paper If you have ink jet printer  
★ For best color matching use color reference tables for printer calibration

★ Use border scales to control the dimensions of the printed layout  
★ Print the layout with maximal available resolution

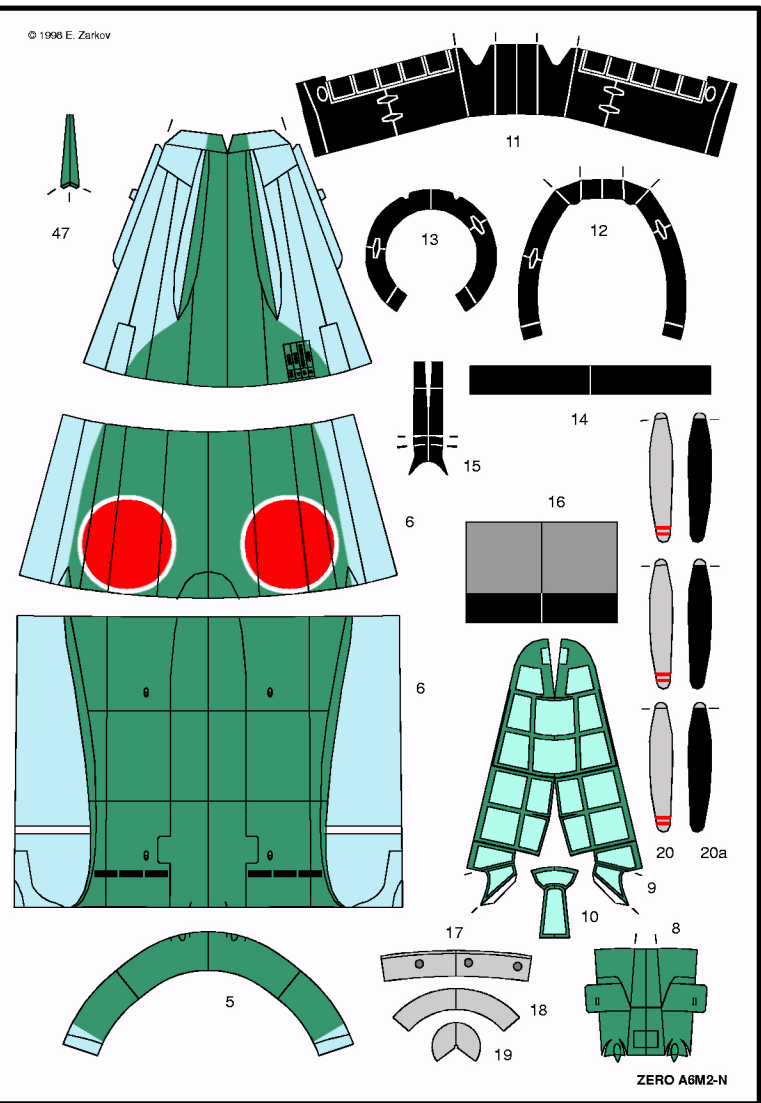
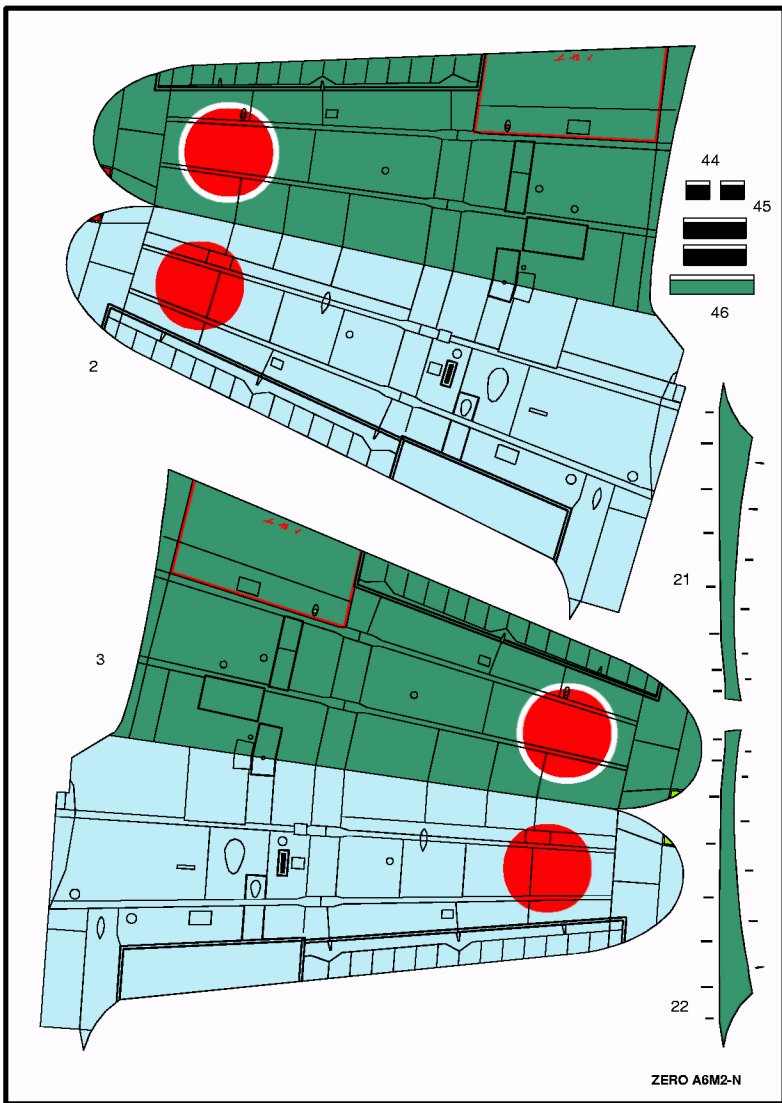

Scale 1:72



★ For individual use only, under no circumstances can this document be resold without written permission by ModelArt.  
★ You can contact us sending E-mail to: [modelart@tusk.icn.bg](mailto:modelart@tusk.icn.bg)

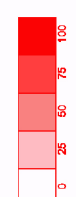
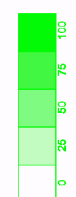
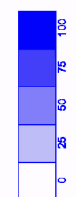
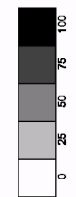
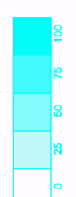
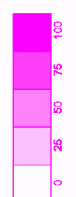
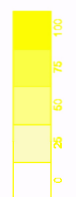
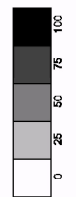

★ For best results use 80 gr/m<sup>2</sup> special coated paper If you have ink jet printer  
★ For best color matching use color reference tables for printer calibration

★ Use border scales to control the dimensions of the printed layout  
★ Print the layout with maximal available resolution

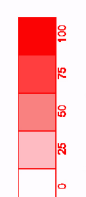
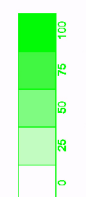
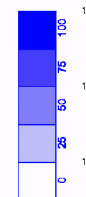
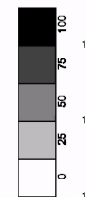
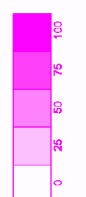
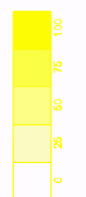
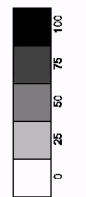
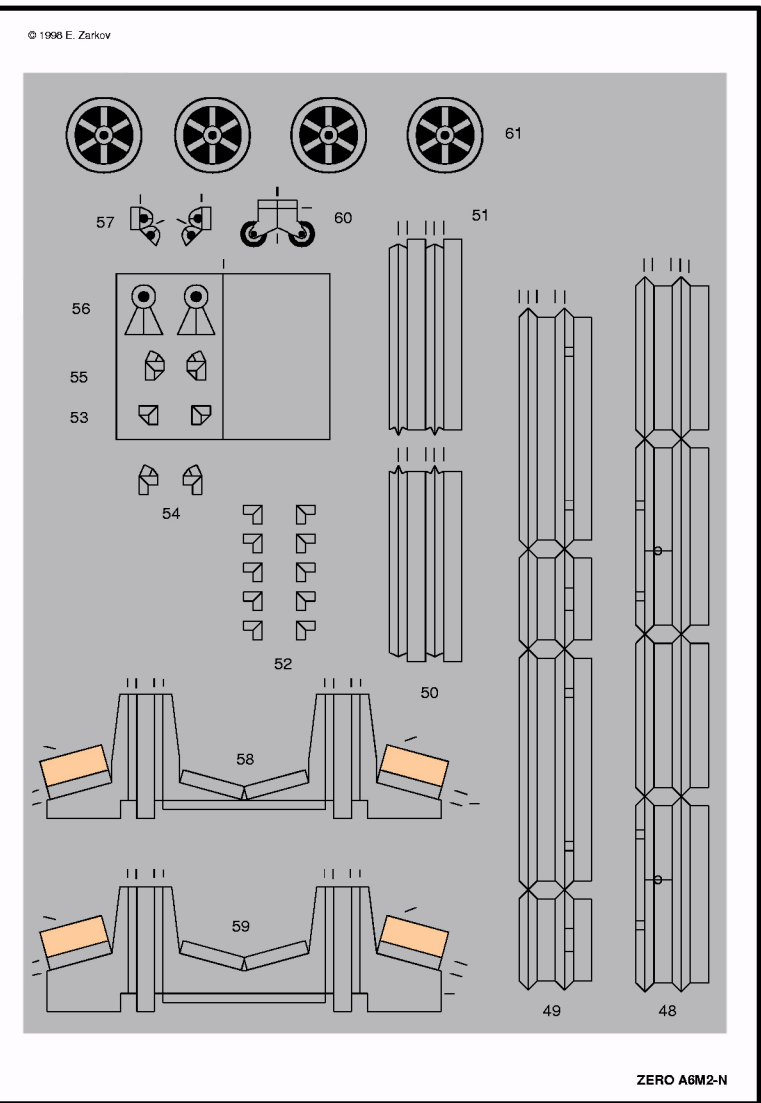
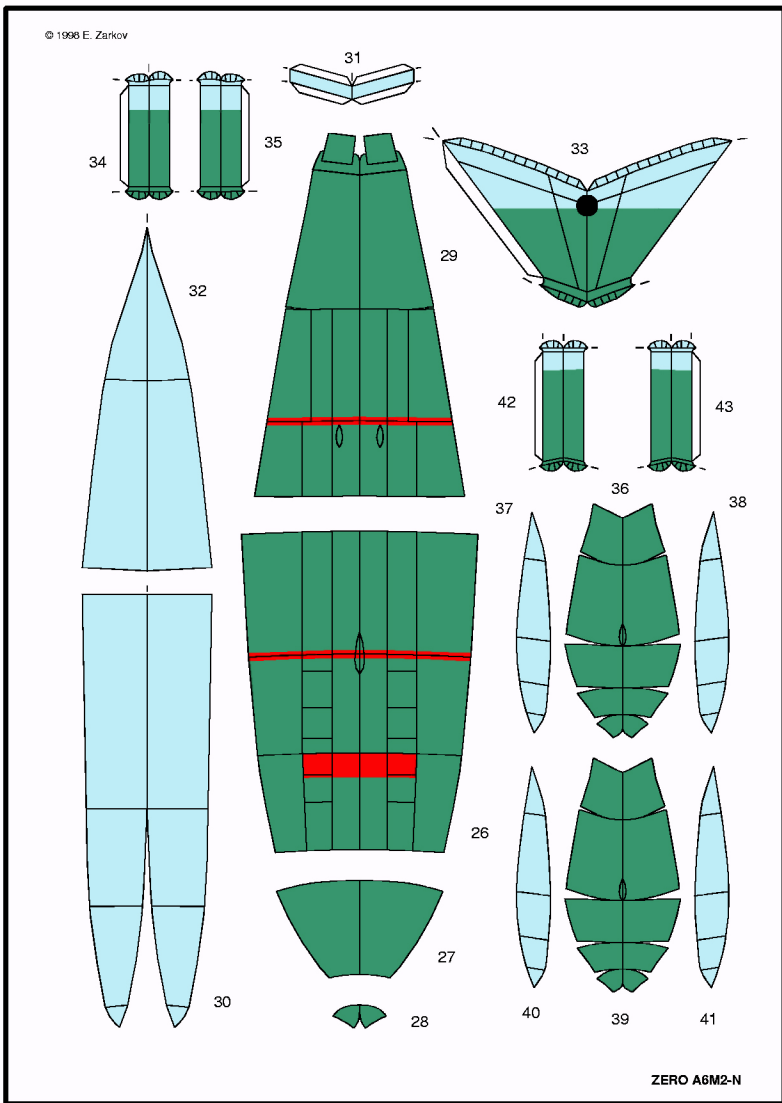

Scale 1:72

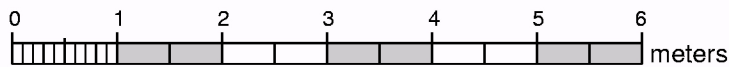

★ For individual use only, under no circumstances can this document be resold without written permission by ModelArt.  
★ You can contact us sending E-mail to: [modelart@tusk.icn.bg](mailto:modelart@tusk.icn.bg)



★ For best results use 80 gr/m<sup>2</sup> special coated paper If you have ink jet printer

★ Print the layout with maximal available resolution

Page 4 of 7

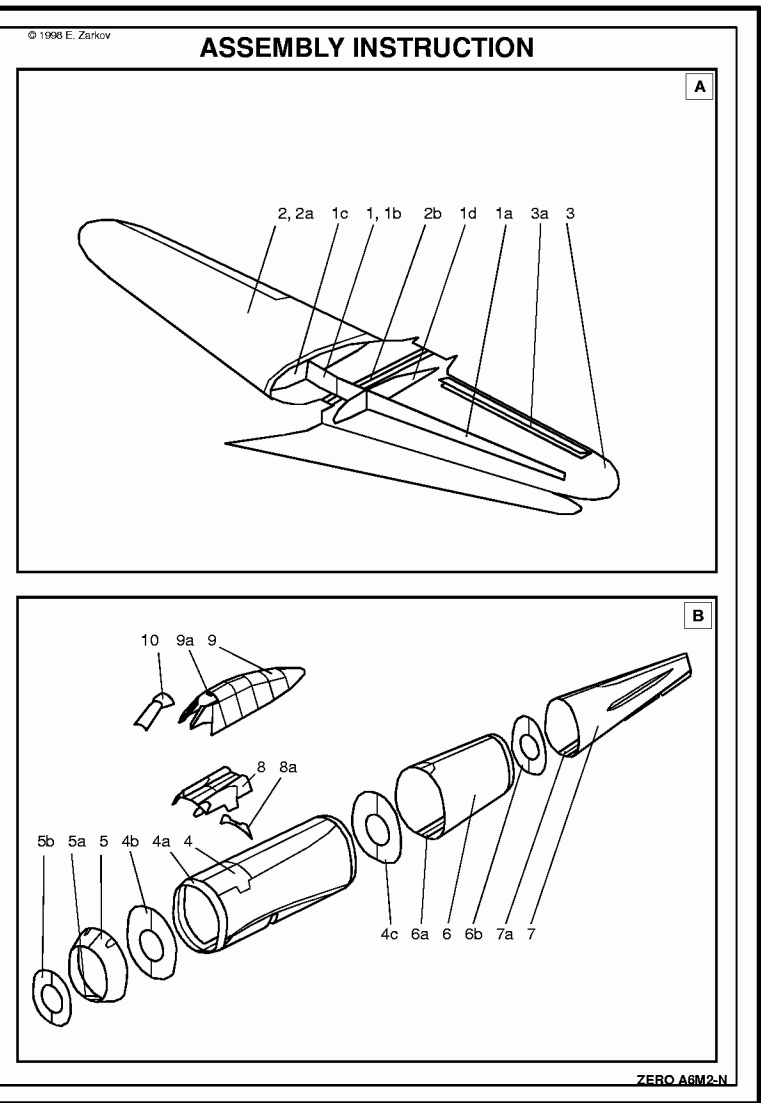
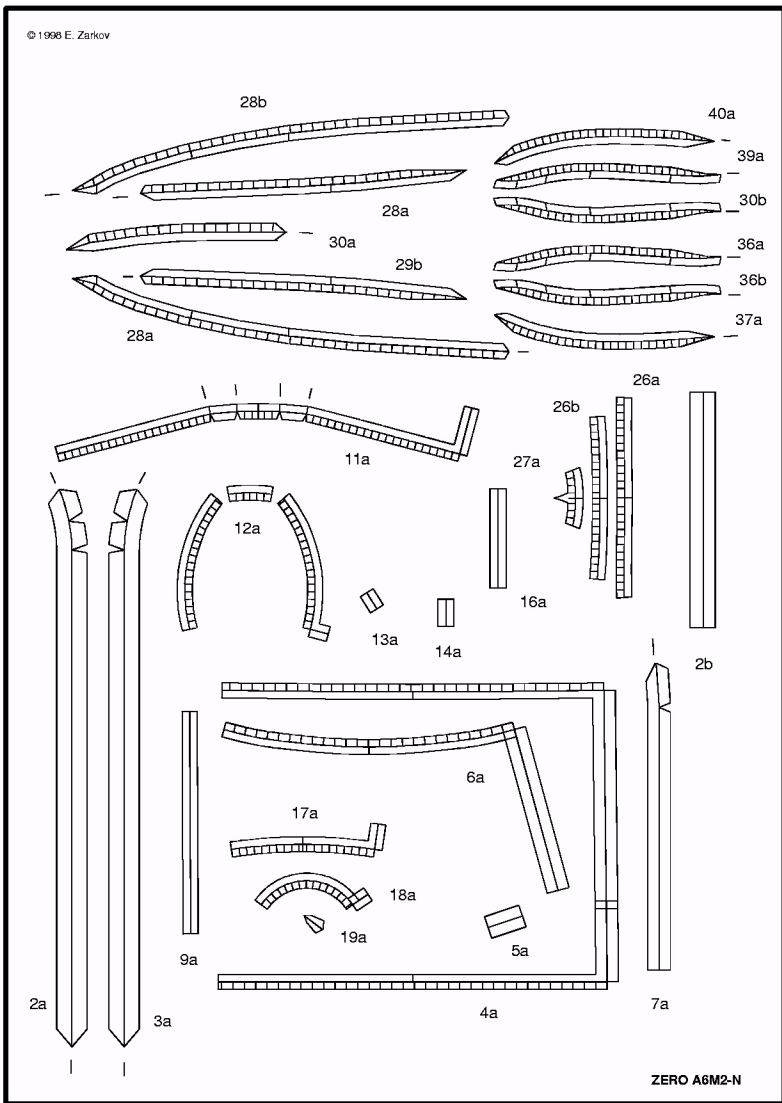

★ For individual use only, under no circumstances can this document be resold without written permission by ModelArt.  
★ You can contact us sending E-mail to: [modelart@tusk.icn.bg](mailto:modelart@tusk.icn.bg)



© 1998 E. Zarkov

### ASSEMBLY INSTRUCTION

**C** Diagram showing the assembly of a small component with parts labeled: pin, 17b, 17a, 17, 17c, 16b, 19,19a, 18a,18b, 18, 20,20a, 16a, 16, 16c, 16d.

**D** Diagram showing the assembly of a larger cylindrical component with parts labeled: 14, 14a, 13,13a, 12a, 12, 11b, 11a, 11, 15, 11c.

**E** Diagram showing the main fuselage assembly with parts labeled: 23, 23a, 24, 24a, 25, 25a, C, D, 35, 21, 47, A, B, 22.

ZERO A6M2-N

© 1998 E. Zarkov

### ASSEMBLY INSTRUCTION

**F** Diagram showing the assembly of the wing and tail sections with parts labeled: 43, 39-39b, 39c, 41, 41,41a, 28, 27a, 27, 26b, 26, 26a, 26c, 29a, 29b, 29, 28b, 28a, 26b, 30a, 30, 31, 32, 42, 36-36b, 36c, 38, 37,37a.

**G** Diagram showing the assembly of the landing gear with parts labeled: 59, 58, 48, 52, 53, 54, 55, 49, 52, 61, 61a, 50, 51, 56, 60.

ZERO A6M2-N

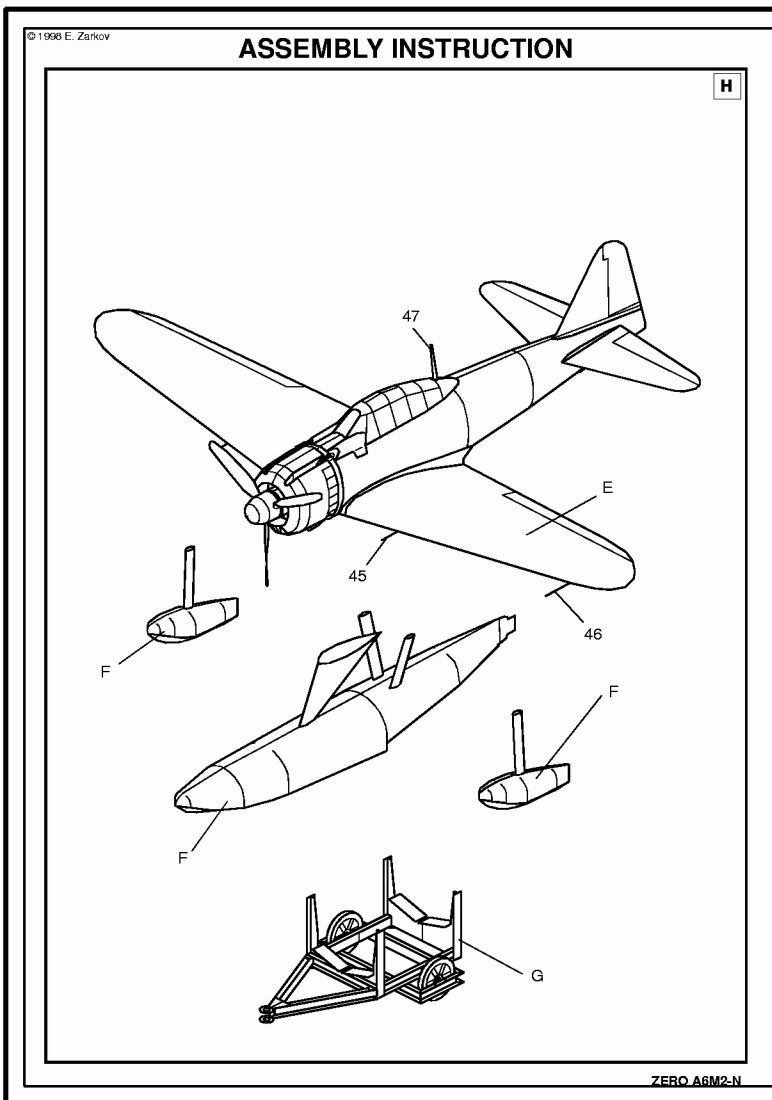

© 1998 E. Zarkov

### ASSEMBLY INSTRUCTION

Study the drawings of assembly steps carefully before starting the work on the model. Make sure you understand the purpose and place of every part.

The assembly requires some basic tools, such as scissors, sharp modeling knife, blunt knife for scoring the fold lines, ruler and needle. Additional materials you need are one pin to make the airscrew's shaft and one piece of cardboard approx. 0.3 mm thick for reinforcing elements and wheels. You'll need of course suitable cement too. For cement application you can use toothpicks or some similar tool (special fine cement applicator is most suitable if you have one).

First of all you must score with the blunt knife all fold lines shown on the cutouts with short thin line marks near the parts. To avoid mistakes and lost parts cut the necessary details shortly before their use. The places where an additional cutting is needed are marked with small thick line marks.

Start with the wing. Assemble the central longerone 1-1b and glue the profiles 1c and 1d to it. Cover the obtained superstructure with the wing's halves 2 and 3, assuring straight edges and avoiding wrapping.

Continue with the fuselage part 4. Bend it in oval form and glue it with connecting stripes 4a. Insert the formers 4b and 4c. Don't forget to cut the hole where the wing's longerone will be placed. Assemble in the same way parts 5-7. Form and glue the machine guns' cowling 8 and its former 8a to 4. Carefully form and assemble the cockpit 10-10b and glue it to the fuselage.

Now focus your attention to the engine cowling. Its assembling is a tricky work, but if you are careful enough, you can achieve excellent results. Form and glue the part 11 as shown on view D of the instruction drawings. Glue the formers 11b and then 11c. 11c must be placed 3mm inside the rear end of 11. Check the fitting of 11 to fuselage part 5 before drying of the glue. Add the parts 12 and 13. The front edge of 13 must be formed in exact circle shape. Insert there 14. Paint the back side of the air intake 15 in black and glue it to the down side of the engine cowling.

Now assemble the propeller and its shaft bearing /parts 16 - 20/ as shown on view C. The propeller must be capable to rotate freely.

ZERO A6M2-N

© 1998 E. Zarkov

## ASSEMBLY INSTRUCTION

Glue the wing to the fuselage. Prepare the aerodynamic wing-fuselage joints 21 and 22, cutting them approximately to their middle line on continuation of the line marks outside the parts before forming them in double curved surfaces. After several dry tests glue them on their places. It is recommended to apply the glue not on them, but on their attachment points on the wing and fuselage.

Assemble and glue the vertical and horizontal stabilizers 23, 24 and 25 to the tail.

Continue with the main and the two support floats. Their assembly sequence is shown on the view F. Assemble the upper surface of the main float first /parts 26-29/, carefully forming them. Glue the connecting stripes 28a, 28b and formers 26c, 26d in it. Assemble the bottom surface /parts 30 - 32/ and glue them to the connecting stripes 29a,b, 28 a,b.

It is recommended that some load must be inserted in the nose of the float for appropriate balancing of the model if the transportation gear will be used for its display.

Glue the parts 33 - 35 to the obtained main float, testing their fitting to the during the drying of the glue. The procedure of assembling the two support floats is similar.

After completing the floats glue them to the model's wing as shown on the view H.

Complete the model, adding the remaining details - antenna mast, Pitot tube and guns.

The Zero A6M2-N is intended to operate from the water basins and you will need a transportation gear for display it on the ground. The transportation gear is supplied in the kit - parts 48 - 61. Refer to view G for its assemble. Do not forget to score the all fold lines before cutting the parts. Form the parts 48 - 51 in the U-shaped spars before glue them together. Use the connecting parts 52 - 55 to strengthen the construction. The wheels parts 61a must be cut from thick card and glued together with 61. Then the wheels must be rounded with sandpaper and their edges must be paint in black.

ZERO A6M2-N

© 1998 E. Zarkov

## ASSEMBLY INSTRUCTION

If you prefer flying model, abandon the propeller blades and the transportation gear. Add some weight in the nose of the main float for appropriate model's balancing - its center of gravity must be on approximately 25% of the average wing chord.

It is interesting that despite the large floats attached, the model still has remarkable flying capabilities.

Now your model is ready. Enjoy your Zero float plane.



ZERO A6M2-N